

**EVALUATION KIT MANUAL
FOLLOWS DATA SHEET**

MAXIM

900MHz SiGe, High IP3, Low-Noise Amplifiers

MAX2642/MAX2643

General Description

The MAX2642/MAX2643 low-cost, high third-order intercept point (IP3), low-noise amplifiers (LNAs) are designed for applications in cellular, ISM, SMR, and PMR systems. They feature a programmable bias, allowing the IP3 and supply current to be optimized for specific applications. These LNAs provide up to 0dBm input IP3 while maintaining a low noise figure of 1.3dB.

The gain for these devices is typically 17dB. The MAX2642 also features a 13dB attenuation step, which extends the LNA's dynamic range. Both devices feature a shutdown mode that minimizes power consumption. On-chip output matching saves board space by reducing the number of external components.

The MAX2642/MAX2643 are designed on a low-noise, advanced silicon-germanium (SiGe) process technology. They operate from a +2.7V to +5.5V single supply and are available in the ultra-small 6-pin SC70 package.

Applications

800MHz/900MHz Cellular Phones
900MHz Cordless Phones
868MHz/900MHz ISM-Band Wireless Data
PMR/SMR/LMR

Typical Operating Circuit

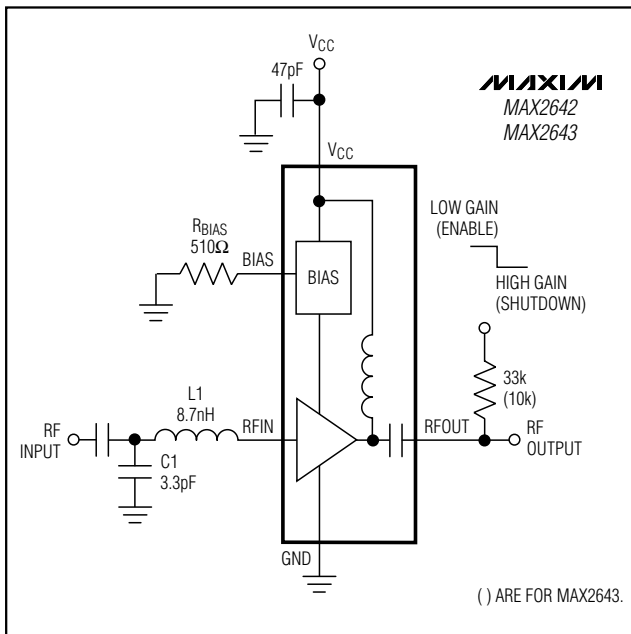

Features

- ◆ Wide Frequency Range: 800MHz to 1000MHz
- ◆ High Output IP3 and Adjustable
 - +17dBm at 5.3mA
 - +7dBm at 2.8mA
- ◆ Low Noise Figure: 1.3dB at 900MHz
- ◆ 13dB Attenuation Step (MAX2642)
- ◆ On-Chip Output Matching
- ◆ Low-Power Shutdown Mode
- ◆ +2.7V to +5.5V Single-Supply Operation
- ◆ Ultra-Small SC70-6 Package

Ordering Information

PART	TEMP. RANGE	PIN-PACKAGE	TOP MARK
MAX2642EXT-T	-40°C to +85°C	6 SC70-6	AAC
MAX2643EXT-T	-40°C to +85°C	6 SC70-6	AAD

Pin Configuration

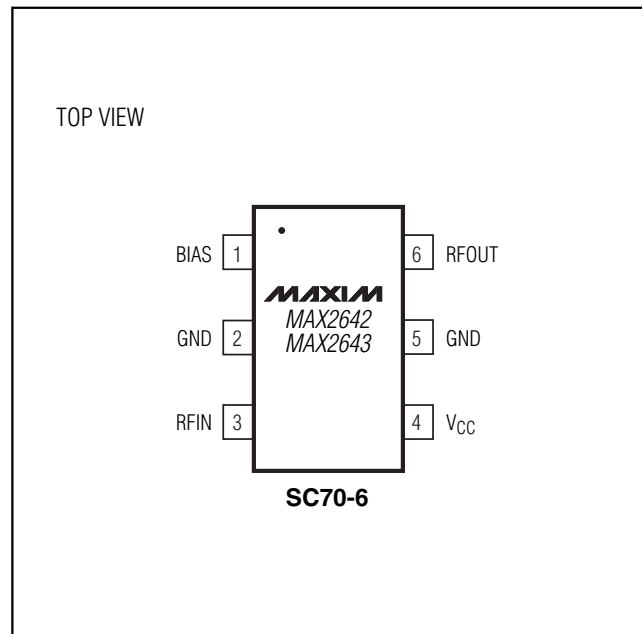

MAXIM

Maxim Integrated Products 1

**For free samples and the latest literature, visit www.maxim-ic.com or phone 1-800-998-8800.
For small orders, phone 1-800-835-8769.**

900MHz SiGe, High IP3, Low-Noise Amplifiers

ABSOLUTE MAXIMUM RATINGS

V_{CC} to GND-0.3V to +6V
 RFOUT to GND-0.3V to (V_{CC} + 0.3V)
 RFIN to GND0 to 0.9V
 RFIN Power (50Ω source)+5dBm
 BIAS to GND0 to +0.3V
 Operating Temperature Range-40°C to +85°C

Maximum Junction Temperature+150°C
 Continuous Power Dissipation (T_A = +70°C)
 SC70-6 (derate 3.1mW/°C above +70°C)245mW
 Storage Temperature Range-65°C to +150°C
 Lead Temperature (soldering, 10s)+300°C

Stresses beyond those listed under "Absolute Maximum Ratings" may cause permanent damage to the device. These are stress ratings only, and functional operation of the device at these or any other conditions beyond those indicated in the operational sections of the specifications is not implied. Exposure to absolute maximum rating conditions for extended periods may affect device reliability.

DC ELECTRICAL CHARACTERISTICS—MAX2642

(V_{CC} = +2.7V to +5.5V, T_A = -40°C to +85°C, no RF signal applied, RFIN and RFOUT are AC-coupled and terminated to 50Ω, high-gain mode. Typical values are at V_{CC} = 3.0V, T_A = +25°C, unless otherwise noted.) (Notes 1, 2, 3)

PARAMETER	CONDITIONS	MIN	TYP	MAX	UNITS
Supply Voltage		2.7		5.5	V
Operating Supply Current	High-gain mode, R _{BIAS} = 510Ω, T _A = +25°C		5.3	6.7	mA
	R _{BIAS} = 510Ω, T _A = -40°C to +85°C			7.5	
	R _{BIAS} = 806Ω		3.6		
	R _{BIAS} = 1.1kΩ		2.8		
	Low-gain mode, R _{BIAS} = 510Ω, T _A = 25°C		5.9		
Shutdown Supply Current	BIAS = unconnected (see <i>Applications Information</i>)		0.2		mA
Gain Control Voltage Input	High-gain mode (Note 4)			0.6	V
	Low-gain mode (Note 5)	2.0			
Gain Control Input Current	High-gain mode (Note 6)	-10		0	μA
	Low-gain mode (Note 7)	0		50	

DC ELECTRICAL CHARACTERISTICS—MAX2643

(V_{CC} = +2.7V to +5.5V, T_A = -40°C to +85°C, no RF signal applied, RFIN and RFOUT are AC-coupled and terminated to 50Ω. Typical values are at V_{CC} = 3.0V, T_A = +25°C, unless otherwise noted.) (Notes 1, 8, 9)

PARAMETER	CONDITIONS	MIN	TYP	MAX	UNITS
Supply Voltage		2.7		5.5	V
Operating Supply Current	R _{BIAS} = 510Ω, T _A = +25°C		5.1	6.5	mA
	R _{BIAS} = 510Ω, T _A = -40°C to +85°C			7.3	
	R _{BIAS} = 806Ω		3.4		
	R _{BIAS} = 1.1kΩ		2.6		
Shutdown Supply Current	Shutdown mode (see <i>Applications Information</i>)		0.2	10	μA
Shutdown Control Input Voltage	Normal operation (Note 10)	2.0			V
	Shutdown mode (Note 11)			0.6	
Shutdown Control Input Current	Normal operation (Note 7)	0		10	μA
	Shutdown mode (Note 6)	-5		5	

900MHz SiGe, High IP3, Low-Noise Amplifiers

MAX2642/MAX2643

AC ELECTRICAL CHARACTERISTICS

(MAX2642/MAX2643 EV kits, P_{RFIN} = -30dBm, f_{RFIN} = 900MHz, input and output are terminated to 50Ω, V_{CC} = +3.0V, T_A = +25°C, R_{BIAS} = 510Ω, unless otherwise noted.) (Note 12)

PARAMETER	CONDITIONS	MIN	TYP	MAX	UNITS
Operating Frequency Range	(Note 13)	800		1000	MHz
Gain (Note 14)	T _A = +25°C	14.5	16.7	19	dB
Gain Variation Over Temperature	T _A = -40°C to +85°C		±0.35	±0.75	dB
Attenuation Step	MAX2642 only		13		dB
Input Third-Order Intercept Point (Note 15)	R _{BIAS} = 510Ω		0		dBm
	R _{BIAS} = 806Ω		-5		
	R _{BIAS} = 1.1kΩ		-10		
Input 1dB Compression Point			-18		dBm
	MAX2642, low-gain mode		-17		
Noise Figure (Note 16)			1.35	1.6	dB
	MAX2642, low-gain mode		4.3		
Input Return Loss		-10	-12		dB
	MAX2642, low-gain mode	-10	-18		
Output Return Loss		-10	-14		dB
	MAX2642, low-gain mode	-10	-11		
Reverse Isolation		-20	-26		dB
	MAX2642, low-gain mode	-10	-17		
Gain-Step Response Time	MAX2642		5	10	μs
Shutdown Response Time	MAX2643		6	10	μs
	MAX2642, through series switch at BIAS		12		

Note 1: Devices are production tested at T_A = +25°C. Minimum and maximum values are guaranteed by design and characterization over temperature and supply voltage.

Note 2: High-gain mode is set for the MAX2642 by connecting RFOUT to GND through a 33kΩ resistor.

Note 3: Low-gain mode is applicable only to the MAX2642 and is set by connecting RFOUT to V_{CC} through a 33kΩ resistor.

Note 4: Maximum DC voltage through a 33kΩ resistor that sets the MAX2642 to operate in high-gain mode.

Note 5: Minimum DC voltage through a 33kΩ resistor that sets the MAX2642 to operate in low-gain mode.

Note 6: DC current required when RFOUT is connected to GND through a 33kΩ resistor (MAX2642) and 10kΩ resistor (MAX2643).

Note 7: DC current required when RFOUT is connected to V_{CC} through a 33kΩ resistor (MAX2642) and 10kΩ resistor (MAX2643).

Note 8: Normal operation is set for the MAX2643 by connecting RFOUT to V_{CC} through a 10kΩ resistor.

Note 9: Shutdown is set for the MAX2643 by connecting RFOUT to GND through a 10kΩ resistor.

Note 10: Minimum DC voltage through a 10kΩ resistor that sets the MAX2643 to operate in normal mode.

Note 11: Maximum DC voltage through a 10kΩ resistor that sets the MAX2643 to operate in shutdown mode.

Note 12: Min/Max limits are guaranteed by design and characterization, except gain is production tested at T_A = +25°C.

Note 13: The part has been characterized at the specified frequency range. Operation outside this range is possible but not guaranteed.

Note 14: Devices are production tested at T_A = +25°C.

Note 15: Measured with two input tones, f₁ = 895MHz and f₂ = 905MHz, both at -30dBm per tone.

Note 16: Excludes PC board losses (0.25dB typical at the input of the MAX2642/MAX2643 EV kit).

900MHz SiGe, High IP3, Low-Noise Amplifiers

Typical Operating Characteristics

(MAX2642/MAX2643 EV kits, $V_{CC} = +3.0V$, $PR_{FIN} = -30dBm$, input and output are terminated to 50Ω , $f_{RFIN} = 900MHz$, $R_{BIAS} = 510\Omega$, high-gain mode (low-gain mode is applicable only to the MAX2642), $T_A = +25^\circ C$, unless otherwise noted.)

MAX2642
INPUT THIRD-ORDER INTERCEPT vs. R_{BIAS} (HIGH GAIN)

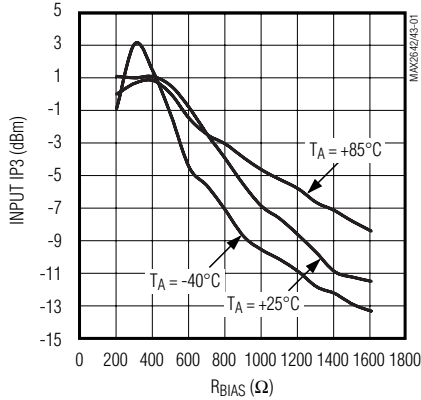

MAX2642
INPUT THIRD-ORDER INTERCEPT vs. R_{BIAS} (LOW GAIN)

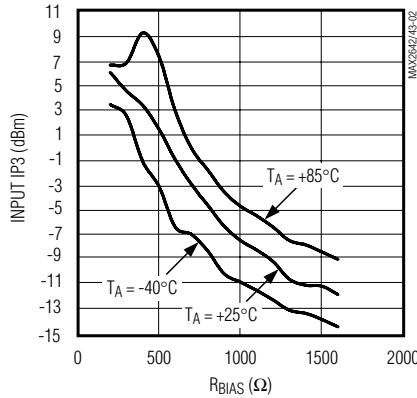

NOISE FIGURE vs. FREQUENCY

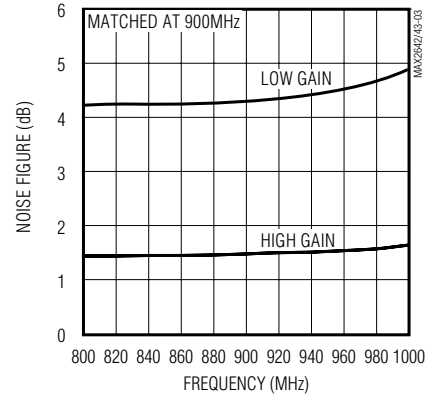

NOISE FIGURE vs. TEMPERATURE

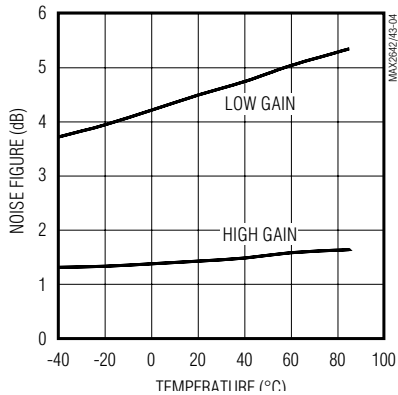

P1dB vs. R_{BIAS}

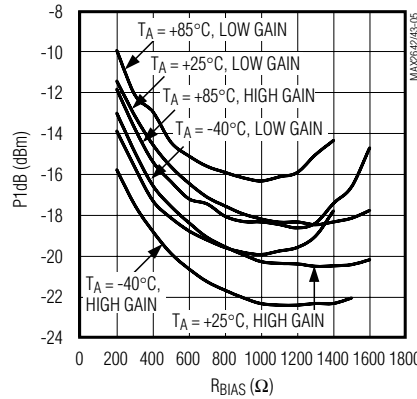

OUTPUT POWER vs. INPUT POWER

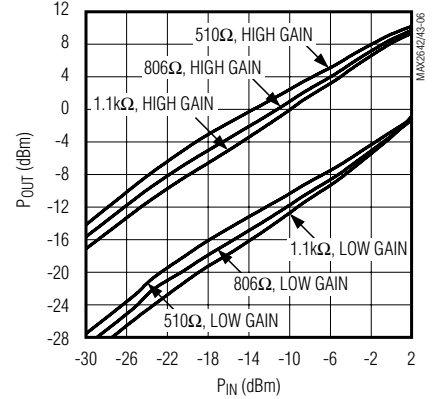

GAIN vs. R_{BIAS}

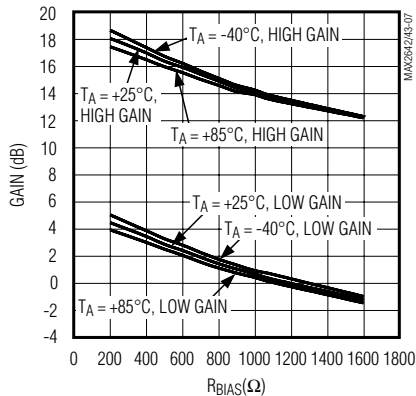

GAIN vs. SUPPLY VOLTAGE

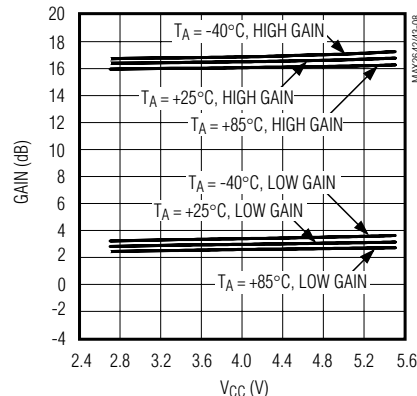

GAIN vs. FREQUENCY

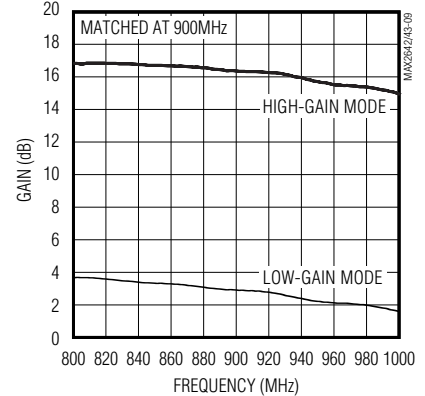

900MHz SiGe, High IP3, Low-Noise Amplifiers

Typical Operating Characteristics (continued)

(MAX2642/MAX2643 EV kits, $V_{CC} = +3.0V$, $PR_{FIN} = -30dBm$, input and output are terminated to 50Ω , $f_{RFIN} = 900MHz$, $R_{BIAS} = 510\Omega$, high-gain mode (low-gain mode is applicable only to the MAX2642), $T_A = +25^\circ C$, unless otherwise noted.)

MAX2642/MAX2643

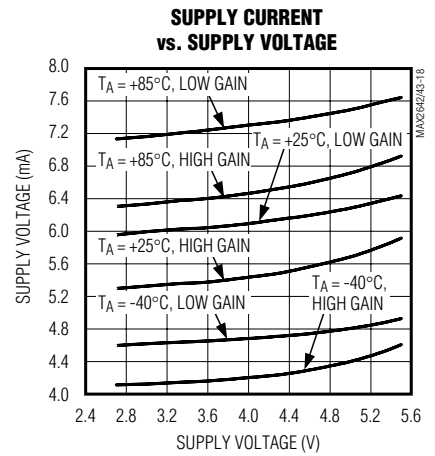
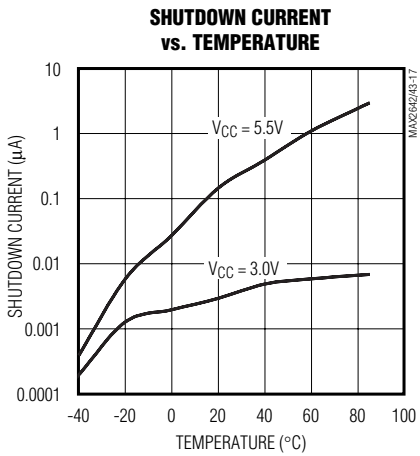
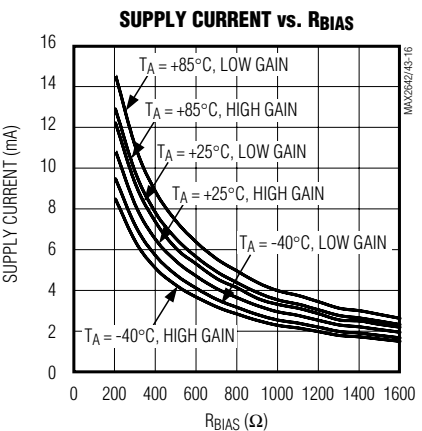
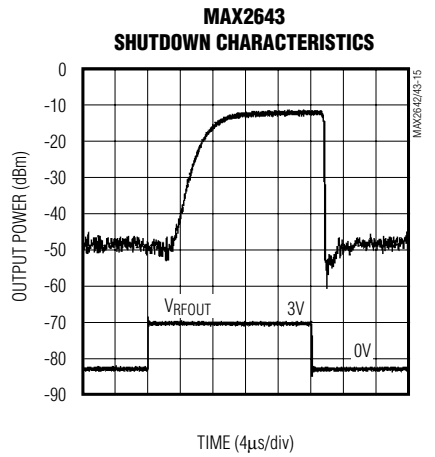
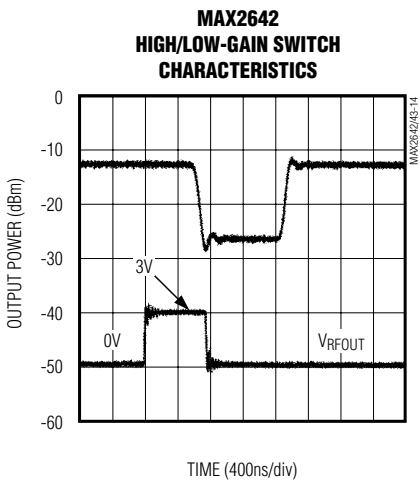
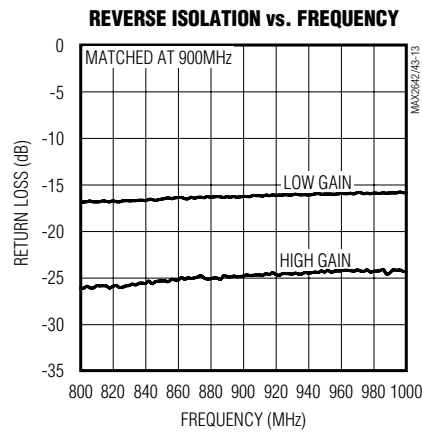
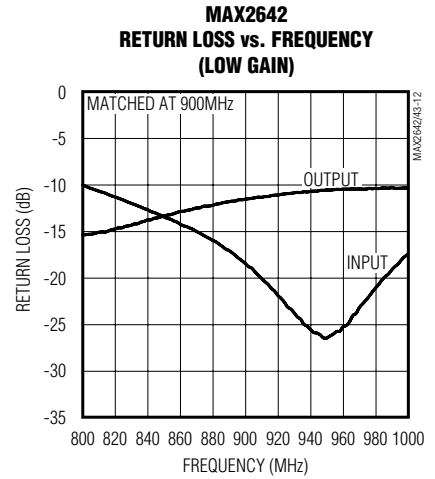
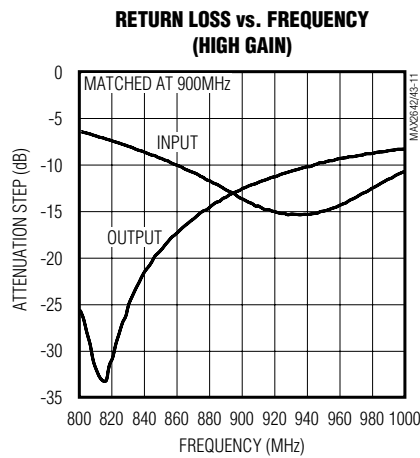
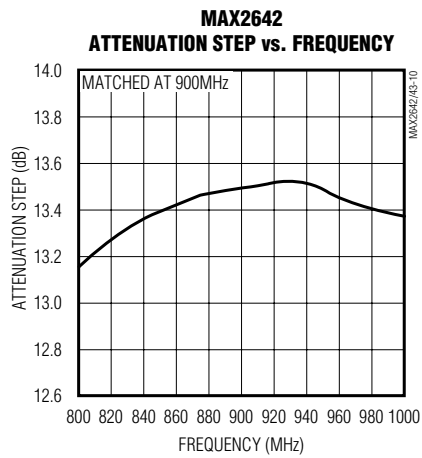

900MHz SiGe, High IP3, Low-Noise Amplifiers

Pin Description

PIN	NAME	FUNCTION
1	BIAS	Resistor Bias Control. Connect a resistor, R_{BIAS} , from BIAS to ground. R_{BIAS} sets IP3 and supply current (see <i>Applications Information</i>). The current through this pin is approximately 50mV divided by R_{BIAS} .
2, 5	GND	Ground. For optimum performance, provide a low-inductance connection to the ground plane.
3	RFIN	Amplifier Input. AC-couple to this pin with a DC-blocking capacitor. External matching network is required for optimum performance.
4	VCC	Supply Voltage. Bypass with a 47pF capacitor directly to ground at the supply pin. Additional bypassing may be necessary for long VCC lines.
6	RFOUT	Amplifier Output. Internally matched to 50 Ω . DC bias on this pin selects gain mode (MAX2642) or shutdown mode (MAX2643) (see <i>Applications Information</i>).

Applications Information

Input Matching

Input matching is required for optimum performance. The MAX2642/MAX2643 require a simple LC matching network, as shown in the *Typical Operating Circuit*. To further reduce cost and external component count, replace the external inductor with a microstrip transmission line. The *Typical Operating Circuit* shows the recommended input-matching networks for the MAX2642/MAX2643 at 900MHz. These values are optimized for best simultaneous gain, noise figure, and return-loss performance. To aid in the design of the matching network for other frequencies, Tables 1–6 list typical device S-parameters for various biases, and Tables 7, 8, and 9 list typical device noise parameters.

Attenuation Step (MAX2642)

The MAX2642's DC bias voltage at RFOUT serves as an attenuation step input. When the DC voltage at RFOUT through a 33k Ω resistor is less than +0.6V, the device is in high-gain mode; if the DC voltage is greater than +2.0V, the device is in low-gain mode. A standard logic output can be applied as shown in the *Typical Operation Circuit*. If no bias is applied, the device is in high-gain mode.

Shutdown

For the MAX2643, the recommended shutdown method is to set the DC voltage at the RFOUT pin in a manner similar to the MAX2642's attenuation step. That is, when the DC voltage at RFOUT is below +0.6V, the device is shut down; if the DC voltage is greater than +2.0V, the device is enabled.

For the MAX2642, shutdown is achieved by leaving BIAS unconnected. Figure 1 shows the suggested shutdown methods. Avoid capacitance at the BIAS pin by connecting the bias resistor from BIAS to the switch. Table 10 summarizes the operational modes.

Layout Issues

A properly designed PC board is essential to any RF/microwave circuit. Use controlled impedance lines on all high-frequency inputs and outputs. Bypass with decoupling capacitors located close to the device VCC pin. For long VCC lines, it may be necessary to add additional decoupling capacitors. These additional capacitors can be located farther away from the device package. Proper grounding of the GND pins is essential. If the PC board uses a topside RF ground, connect it directly to all GND pins. For a board where the ground plane is not on the component layer, the best technique is to connect the GND pins to the board with a plated through-hole located close to the package.

900MHz SiGe, High IP3, Low-Noise Amplifiers

MAX2642/MAX2643

Table 1. MAX2642/MAX2643 Typical Scattering Parameters

(RBIAS = 510Ω, high-gain mode, VCC = +3.0V, TA = +25°C.)

FREQ (MHz)	S11 MAG	S11 PHASE (DEGREES)	S21 MAG	S21 PHASE (DEGREES)	S12 MAG	S12 PHASE (DEGREES)	S22 MAG	S22 PHASE (DEGREES)
500	0.832641	-69.5831	2.390806	-119.18	0.010763	166.6047	0.878515	-74.01422
600	0.825168	-83.7622	3.836967	-136.451	0.019608	167.8741	0.731997	-98.95091
700	0.785389	-97.3356	4.983279	-161.126	0.02988	148.5203	0.481344	-125.1027
800	0.73798	-108.682	5.320575	174.5337	0.036197	134.8794	0.215462	-142.0387
820	0.728099	-110.578	5.286	170.3323	0.037193	132.505	0.171633	-141.9486
840	0.718704	-112.499	5.241719	166.3987	0.037266	129.1671	0.135415	-139.9869
860	0.711335	-114.276	5.185213	162.4763	0.039143	128.0447	0.100779	-133.8375
880	0.705742	-115.973	5.118265	158.9238	0.039563	128.4158	0.076864	-121.3533
900	0.699509	-117.585	5.050356	155.6292	0.042586	128.075	0.062918	-102.3972
920	0.695913	-119.117	4.973824	152.4338	0.041805	126.9362	0.06007	-81.32555
940	0.690406	-120.995	4.897571	149.4286	0.04301	122.9564	0.065287	-62.51575
960	0.68522	-122.642	4.826106	146.6999	0.046528	122.0997	0.077374	-50.8638
980	0.681722	-124.345	4.735407	143.8275	0.04524	121.0474	0.090494	-44.30662
1000	0.675328	-126.035	4.650673	141.4611	0.046036	120.1779	0.103072	-40.69565
1100	0.657582	-134.195	4.29304	130.7613	0.053825	116.4169	0.156945	-34.00603
1200	0.635999	-141.558	3.998256	121.5475	0.061434	109.6365	0.198686	-32.62157
1300	0.616881	-147.886	3.777511	113.2893	0.066092	103.583	0.240437	-33.12784
1400	0.602418	-153.992	3.547677	105.6808	0.075756	99.08275	0.283245	-36.62076
1500	0.587409	-158.21	3.338385	97.62961	0.076491	92.84421	0.326279	-40.68451

900MHz SiGe, High IP3, Low-Noise Amplifiers

MAX2642/MAX2643

Table 2. MAX2642/MAX2643 Typical Scattering Parameters

(RBIAS = 806Ω, high-gain mode, VCC = +3.0V, TA = +25°C.)

FREQ (MHz)	S11 MAG	S11 PHASE (DEGREES)	S21 MAG	S21 PHASE (DEGREES)	S12 MAG	S12 PHASE (DEGREES)	S22 MAG	S22 PHASE (DEGREES)
500	0.865705	-67.5629	1.788918	-115.899	0.009763	164.6001	0.880237	-73.81893
600	0.853946	-80.7084	2.926709	-132.446	0.021656	165.374	0.739354	-99.52715
700	0.820187	-94.1329	3.884537	-157.426	0.029766	148.5047	0.49107	-128.1454
800	0.775557	-104.428	4.237314	177.9528	0.036728	130.1148	0.216415	-153.3392
820	0.765138	-106.343	4.226094	173.3886	0.038253	129.5942	0.166772	-157.7809
840	0.759	-108.042	4.214913	169.298	0.038842	128.7876	0.121201	-160.7175
860	0.7495	-109.928	4.182436	165.3457	0.040084	127.3742	0.082263	-160.9349
880	0.741722	-111.683	4.134814	161.548	0.04118	127.2791	0.045314	-158.0615
900	0.736069	-113.369	4.085018	157.8688	0.04194	125.3719	0.016624	-133.0426
920	0.728957	-115.127	4.032105	154.6118	0.044642	123.3553	0.021369	-38.41852
940	0.724118	-116.951	3.965561	151.3371	0.044574	121.8034	0.043243	-17.90431
960	0.719676	-118.584	3.903364	148.3141	0.044792	120.7695	0.066898	-14.20027
980	0.714506	-120.313	3.83867	145.3527	0.045551	118.109	0.084163	-12.76007
1000	0.709103	-121.959	3.777	142.7001	0.046434	119.036	0.102269	-13.88384
1100	0.691292	-129.341	3.483283	131.8578	0.054775	114.7347	0.169693	-18.18657
1200	0.67035	-136.703	3.27255	121.9156	0.061407	108.2008	0.220689	-21.72272
1300	0.650556	-143.014	3.09574	113.1691	0.064829	103.5856	0.26965	-24.86245
1400	0.635363	-148.565	2.934971	105.3286	0.075142	97.9223	0.315264	-30.21604
1500	0.616202	-153.536	2.756155	96.43876	0.074664	92.88747	0.360706	-35.70454

900MHz SiGe, High IP3, Low-Noise Amplifiers

Table 3. MAX2642/MAX2643 Typical Scattering Parameters

(RBIAS = 1.1k Ω , high-gain mode, VCC = +3.0V, TA = +25°C.)

FREQ (MHz)	S11 MAG	S11 PHASE (DEGREES)	S21 MAG	S11 PHASE (DEGREES)	S12 MAG	S12 PHASE (DEGREES)	S22 MAG	S22 PHASE (DEGREES)
500	0.878512	-66.0475	1.445864	-114.652	0.011049	175.9688	0.882121	-73.97408
600	0.86813	-79.0081	2.398259	-131.281	0.01977	166.0087	0.745577	-100.0799
700	0.834311	-91.9431	3.218232	-155.869	0.033312	149.3926	0.502282	-129.8978
800	0.793611	-102.384	3.544617	179.1002	0.038594	131.9641	0.223248	-160.5161
820	0.783644	-104.098	3.563583	174.4488	0.040112	131.6111	0.173175	-166.8809
840	0.774329	-105.921	3.546937	170.1934	0.038383	128.1902	0.126351	-173.2415
860	0.767016	-107.766	3.529998	165.871	0.04004	126.4807	0.086328	178.6352
880	0.762463	-109.461	3.500193	161.8438	0.041375	124.4402	0.049822	167.1237
900	0.753622	-111.254	3.463616	158.0655	0.043587	123.8527	0.020398	128.5957
920	0.748921	-113.148	3.419726	154.6982	0.043975	123.9237	0.024778	48.71712
940	0.743011	-114.988	3.36768	151.2749	0.045614	121.0385	0.04661	18.5372
960	0.737437	-116.709	3.309045	148.0373	0.044426	118.9012	0.070736	10.02515
980	0.733572	-118.379	3.261195	145.4087	0.046581	118.374	0.092621	4.197083
1000	0.729122	-119.87	3.203007	142.5148	0.048343	116.9249	0.110062	-0.293905
1100	0.710864	-127.286	2.970843	130.8328	0.055616	115.1579	0.183756	-10.46082
1200	0.688941	-134.781	2.789044	120.5809	0.061803	105.9973	0.238134	-16.81635
1300	0.668471	-141.275	2.637086	111.4044	0.065281	100.6171	0.289607	-21.34393
1400	0.655478	-146.685	2.491515	103.3737	0.073887	96.84646	0.335752	-27.6725
1500	0.638124	-152.12	2.352013	94.07729	0.077901	90.34502	0.381179	-33.81158

MAX2642/MAX2643

900MHz SiGe, High IP3, Low-Noise Amplifiers

Table 4. MAX2642 Typical Scattering Parameters

(RBIAS = 510Ω, low-gain mode, VCC = +3.0V, TA = +25°C.)

FREQ (MHz)	S11 MAG	S11 PHASE (DEGREES)	S21 MAG	S21 PHASE (DEGREES)	S12 MAG	S12 PHASE (DEGREES)	S22 MAG	S22 PHASE (DEGREES)
500	0.757279	-68.0641	0.186886	-175.019	0.032297	163.9787	0.87996	-73.8882
600	0.75734	-84.3042	0.715305	-146.702	0.066113	148.5775	0.71413	-98.6736
700	0.696969	-98.422	1.140352	-174.61	0.099941	124.8504	0.449346	-121.361
800	0.626874	-107.497	1.272844	157.4571	0.115242	103.1406	0.201112	-127.267
820	0.616023	-108.596	1.267541	152.644	0.116521	100.3007	0.165909	-123.451
840	0.608751	-109.794	1.258504	148.0772	0.117601	97.74948	0.137812	-116.955
860	0.600617	-110.754	1.242296	143.7583	0.119312	95.48379	0.118557	-107.057
880	0.596488	-111.776	1.22394	139.7228	0.122318	93.07481	0.106845	-93.617
900	0.593722	-112.739	1.203776	135.9799	0.124196	90.21815	0.103446	-81.5882
920	0.590101	-113.712	1.181885	132.3471	0.125203	86.9857	0.108109	-70.2192
940	0.588409	-114.834	1.156787	128.909	0.126462	84.27329	0.116508	-61.7886
960	0.589625	-115.806	1.129734	125.6671	0.127369	82.07469	0.129083	-55.1485
980	0.588079	-116.828	1.102653	122.5478	0.127952	80.98836	0.140436	-52.3827
1000	0.588646	-117.975	1.074686	119.9067	0.12743	79.48192	0.151608	-48.4917
1100	0.597562	-124.002	0.952505	108.5103	0.134236	72.42102	0.206216	-43.8143
1200	0.6066	-129.873	0.852237	99.7348	0.138354	65.08001	0.252003	-43.9084
1300	0.617079	-136.272	0.778154	92.06538	0.142609	58.40858	0.295689	-46.8967
1400	0.628195	-142.195	0.718399	85.7905	0.153771	52.64912	0.33692	-51.7496
1500	0.640304	-147.446	0.656535	78.77735	0.149518	46.71009	0.374046	-56.7658

900MHz SiGe, High IP3, Low-Noise Amplifiers

MAX2642/MAX2643

Table 5. MAX2642 Typical Scattering Parameters

(RBIAS = 806Ω, low-gain mode, VCC = +3.0V, TA = +25°C.)

FREQ (MHz)	S11 MAG	S11 PHASE (DEGREES)	S21 MAG	S21 PHASE (DEGREES)	S12 MAG	S12 PHASE (DEGREES)	S22 MAG	S22 PHASE (DEGREES)
500	0.800327	-67.1945	0.142134	-174.341	0.034805	161.583	0.88084	-73.57176
600	0.793203	-81.9096	0.543072	-143.848	0.067027	146.5234	0.719105	-99.08562
700	0.736656	-95.21	0.885917	-171.542	0.101665	122.4962	0.449898	-124.5513
800	0.676741	-103.586	1.005172	159.8524	0.114894	101.0446	0.183694	-136.0146
820	0.666567	-104.763	1.005053	154.9507	0.115809	97.08399	0.143872	-133.6185
840	0.660377	-106.009	0.998032	150.1753	0.118042	94.72314	0.109486	-125.307
860	0.651791	-107.125	0.990225	145.7345	0.118937	91.64486	0.085206	-112.6535
880	0.651106	-108.175	0.978178	141.4141	0.121575	89.19647	0.071836	-92.15154
900	0.643048	-109.302	0.961026	137.4554	0.120654	86.75212	0.0738	-70.16955
920	0.643064	-110.728	0.942776	133.7632	0.123645	83.74419	0.084769	-54.68721
940	0.641773	-111.842	0.923851	130.1361	0.123333	80.71953	0.098778	-46.62902
960	0.640079	-113.103	0.90238	126.9098	0.12394	78.64308	0.117484	-40.63098
980	0.641175	-114.555	0.879907	123.7699	0.123001	76.38534	0.132356	-38.28101
1000	0.641025	-115.739	0.857382	120.9598	0.122316	74.64619	0.145883	-35.93101
1100	0.647379	-121.754	0.760331	109.613	0.127968	68.72507	0.209937	-35.70716
1200	0.651053	-128.101	0.685309	100.4887	0.131962	62.04964	0.260554	-37.84105
1300	0.65637	-134.578	0.623917	93.1824	0.132337	56.01043	0.303628	-41.83445
1400	0.662035	-139.905	0.582929	86.98415	0.142149	51.5965	0.34549	-46.96146
1500	0.665418	-145.73	0.53929	79.50793	0.138295	45.87176	0.382116	-52.44192

900MHz SiGe, High IP3, Low-Noise Amplifiers

MAX2642/MAX2643

Table 6. MAX2642 Typical Scattering Parameters

(RBIAS = 1.1Ω, low-gain mode, VCC = +3.0V, TA = +25°C.)

FREQ (MHz)	S11 MAG	S11 PHASE (DEGREES)	S21 MAG	S21 PHASE (DEGREES)	S12 MAG	S12 PHASE (DEGREES)	S22 MAG	S22 PHASE (DEGREES)
500	0.822139	-66.5029	0.116321	-174.275	0.03386	162.1213	0.879442	-73.74798
600	0.808058	-80.314	0.439837	-143.103	0.065964	146.0581	0.724703	-99.6653
700	0.755255	-93.0574	0.72921	-170.915	0.0999	121.1126	0.457496	-126.0206
800	0.703243	-101.403	0.838753	160.4014	0.115609	98.56961	0.181063	-141.9359
820	0.694461	-102.693	0.839017	155.3972	0.116069	94.64113	0.138616	-140.7761
840	0.687512	-103.96	0.836295	150.551	0.117021	92.14834	0.098228	-136.1769
860	0.683106	-105.16	0.82921	145.8221	0.116949	88.49732	0.068493	-122.4536
880	0.678346	-106.424	0.818297	141.5384	0.119552	86.39616	0.049577	-93.92001
900	0.674815	-107.654	0.807407	137.4799	0.121372	83.98519	0.052964	-64.05054
920	0.672424	-109.092	0.791395	133.7297	0.122328	80.33097	0.070844	-44.45571
940	0.671111	-110.488	0.775375	129.9834	0.120584	78.46327	0.089595	-37.15094
960	0.669825	-111.738	0.757139	126.6652	0.120221	75.62165	0.110248	-31.16879
980	0.670457	-113.266	0.737655	123.3462	0.120881	73.65825	0.125584	-29.76813
1000	0.669392	-114.649	0.719178	120.6109	0.11967	71.31908	0.14489	-28.6178
1100	0.674741	-120.914	0.638029	109.1083	0.123318	66.28802	0.21152	-30.89364
1200	0.675283	-127.763	0.575544	100.3768	0.125601	58.42145	0.264377	-34.10688
1300	0.679379	-134.523	0.52948	92.75184	0.126691	54.07481	0.308252	-38.78385
1400	0.682813	-139.869	0.494615	86.94255	0.133067	49.83734	0.348366	-44.59462
1500	0.681251	-145.854	0.462984	79.4068	0.128294	43.41453	0.386044	-50.022

900MHz SiGe, High IP3, Low-Noise Amplifiers

MAX2642/MAX2643

Table 7. MAX2642/MAX2643 Typical Noise Parameters

(RBIAS = 510Ω, high-gain mode, VCC = +3.0V, TA = +25°C.)

FREQUENCY (MHz)	NFMIN (dB)	Γ_{opt} MAG	Γ_{opt} PHASE (DEGREES)	RN (Ω)
800	1.011	0.3074	55.04	13.11
850	1.023	0.3016	58.89	13.28
875	1.030	0.2990	60.83	13.38
900	1.037	0.2965	62.77	13.49
925	1.045	0.2942	64.70	13.60
950	1.053	0.2919	66.62	13.72
1000	1.069	0.2879	70.40	13.96

Table 8. MAX2642/MAX2643 Typical Noise Parameters

(RBIAS = 806Ω, high-gain mode, VCC = +3.0V, TA = +25°C.)

FREQUENCY (MHz)	NFMIN (dB)	Γ_{opt} MAG	Γ_{opt} PHASE (DEGREES)	RN (Ω)
800	1.149	0.3905	54.95	15.14
850	1.161	0.3832	58.63	15.32
875	1.168	0.3798	60.49	15.43
900	1.176	0.3766	62.35	15.55
925	1.185	0.3735	64.21	15.68
950	1.194	0.3705	66.06	15.82
1000	1.213	0.3650	69.72	16.11

Table 9. MAX2642/MAX2643 Typical Noise Parameters

(RBIAS = 1.1kΩ, high-gain mode, VCC = +3.0V, TA = +25°C.)

FREQUENCY (MHz)	NFMIN (dB)	Γ_{opt} MAG	Γ_{opt} PHASE (DEGREES)	RN (Ω)
800	1.312	0.4473	55.50	17.64
850	1.325	0.4391	59.12	17.83
875	1.333	0.4353	60.96	17.96
900	1.342	0.4317	62.79	18.11
925	1.352	0.4282	64.63	18.26
950	1.363	0.4249	66.46	18.43
1000	1.385	0.4186	70.08	18.78

900MHz SiGe, High IP3, Low-Noise Amplifiers

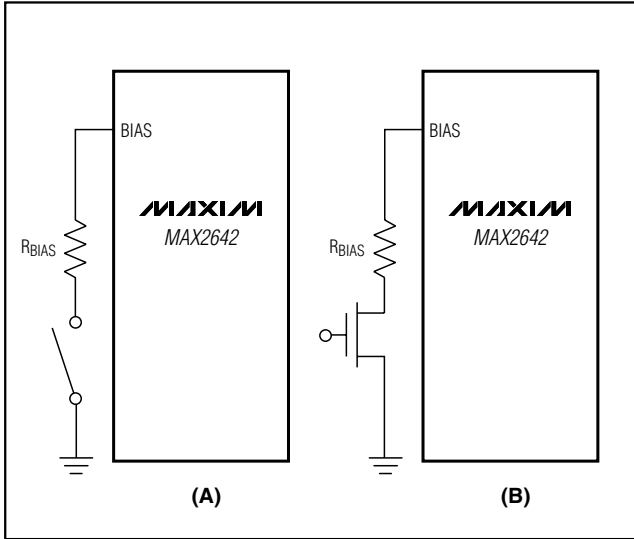

Figure 1. MAX2642 Recommended Shutdown Configurations

Table 10. Gain Selection and Shutdown Modes

PART	CONTROL VOLTAGE = V_{CC}	CONTROL VOLTAGE = 0
MAX2642	Low Gain	High Gain
MAX2643	Enabled	Shutdown

Chip Information

TRANSISTOR COUNT: 158

900MHz SiGe, High IP3, Low-Noise Amplifiers

Package Information

MAX2642/MAX2643

SC70, 6LEPS

The drawing shows three views of the package: a top view, a side view, and a bottom view. The top view shows a rectangular package with three pins on each side. Dimensions include D (total width), e (pin spacing), HE (height to top of pins), E (height to bottom of pins), b (pin width), PIN 1 (location of the first pin), and A1 (bottom view width). The side view shows the package height L1 and pin height L. The bottom view shows dimensions A2 (total width) and A (height to bottom of pins).

SYMBOL	MIN	MAX
e	0.65	BSC
D	1.80	2.20
b	0.15	0.30
E	1.15	1.35
HE	1.80	2.40
Q1	0.10	0.40
A2	0.80	1.00
A1	0.00	0.10
A	0.80	1.10
c	0.10	0.18
L	0.10	0.30
L1	0.425 TYP.	

1. ALL DIMENSIONS ARE IN MILLIMETERS
2. DIMENSIONS ARE INCLUSIVE OF PLATING
3. DIMENSIONS ARE EXCLUSIVE OF MOLD FLASH & METAL BURR
4. ALL SPECIFICATIONS COMPLY TO EIAJ SC70
5. COPLANARITY 4 MILS. MAX.
6. PIN 1 I.D. DOT

MAXIM			
PROPRIETARY INFORMATION			
TITLE: PACKAGE OUTLINE, SC70, 6L			
APPROVAL	DOCUMENT CONTROL NO.	REV	1/1
	21-0077	B	

**900MHz SiGe, High IP3,
Low-Noise Amplifiers**

NOTES

X-ON Electronics

Largest Supplier of Electrical and Electronic Components

Click to view similar products for [RF Amplifier](#) category:

Click to view products by [Maxim](#) manufacturer:

Other Similar products are found below :

[A82-1](#) [BGA622H6820XTSA1](#) [BGA 728L7 E6327](#) [BGB719N7ESDE6327XTMA1](#) [HMC397-SX](#) [HMC405](#) [HMC561-SX](#) [HMC8120-SX](#)
[HMC8121-SX](#) [HMC-ALH382-SX](#) [HMC-ALH476-SX](#) [SE2433T-R](#) [SMA3101-TL-E](#) [SMA39](#) [A66-1](#) [A66-3](#) [A67-1](#) [LX5535LQ](#) [LX5540LL](#)
[MAAM02350](#) [HMC3653LP3BETR](#) [HMC549MS8GETR](#) [HMC-ALH435-SX](#) [SMA101](#) [SMA32](#) [SMA411](#) [SMA531](#) [SST12LP17E-XX8E](#)
[SST12LP19E-QX6E](#) [WPM0510A](#) [HMC5929LS6TR](#) [HMC5879LS7TR](#) [HMC1126](#) [HMC1087F10](#) [HMC1086](#) [HMC1016](#) [SMA1212](#)
[MAX2689EWS+T](#) [MAAMSS0041TR](#) [MAAM37000-A1G](#) [LTC6430AIUF-15#PBF](#) [CHA5115-QDG](#) [SMA70-2](#) [SMA4011](#) [A231](#) [HMC-](#)
[AUH232](#) [LX5511LQ](#) [LX5511LQ-TR](#) [HMC7441-SX](#) [HMC-ALH310](#)