

MAX31723PMB1 Peripheral Module

General Description

The MAX31723PMB1 peripheral module provides the necessary hardware to interface the MAX31723 digital thermometer and thermostat to any system that utilizes Pmod™-compatible expansion ports configurable for SPI and/or GPIO communication. The IC provides temperature-to-digital conversion with no additional components. Temperature readings are communicated from the device over an SPI interface or a 3-wire serial interface. The choice of interface is selectable by the user. For applications that require greater temperature resolution, the user can adjust the readout resolution from 9 bits to 12 bits. This is particularly useful in applications where thermal runaway conditions must be detected quickly. The thermostat has a dedicated open-drain output (\overline{TOUT}). Two thermostat operating modes (comparator and interrupt) control thermostat operation based on user-defined nonvolatile trip points (T_{HIGH} and T_{LOW}).

Refer to the MAX31723 IC data sheet for detailed information regarding operation of the IC.

Features

- ◆ Measures Temperatures from -55°C to +125°C
- ◆ Thermometer Accuracy is $\pm 0.5^\circ\text{C}$
- ◆ Thermometer Resolution is Configurable from 9 Bits to 12 Bits
- ◆ Thermostat Output with User-Defined Nonvolatile Thresholds
- ◆ SPI or 3-Wire Interface Selectable through Jumpers
- ◆ 6-Pin Pmod-Compatible Connector (SPI/GPIO)
- ◆ Example Software Written in C for Portability
- ◆ RoHS Compliant
- ◆ Proven PCB Layout
- ◆ Fully Assembled and Tested

[Ordering Information](#) appears at end of data sheet.

MAX31723PMB1 Peripheral Module

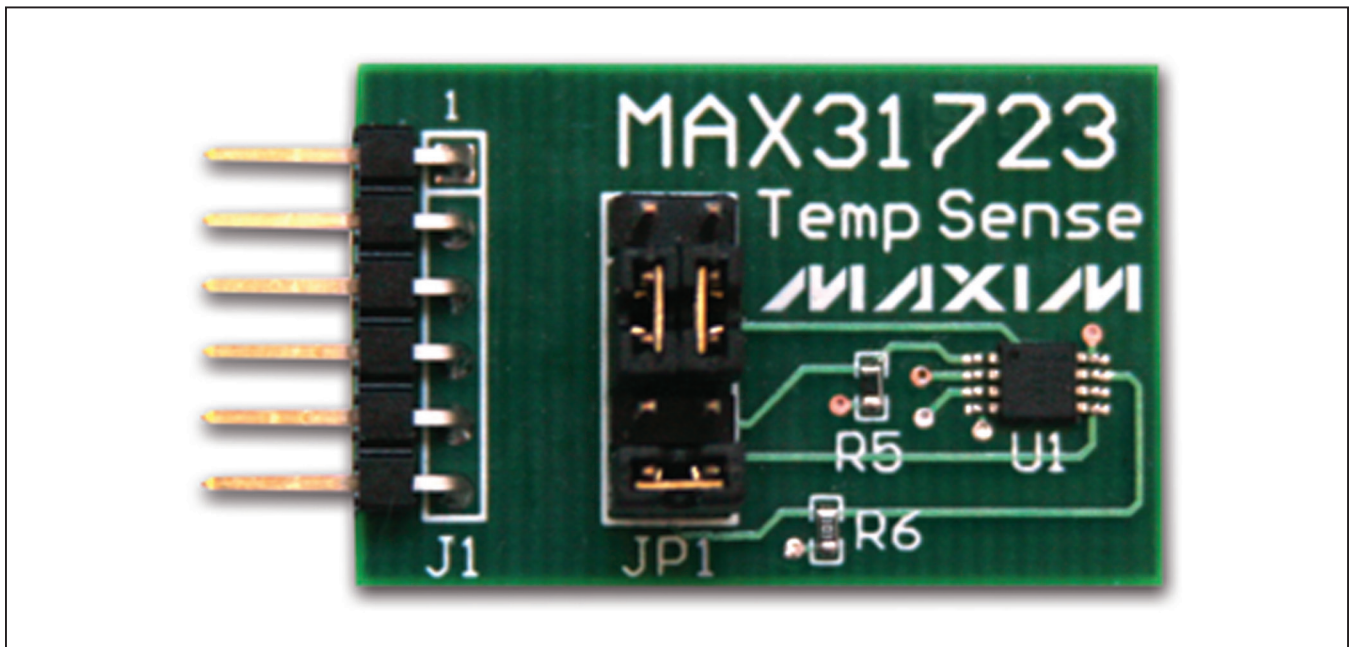

Pmod is a trademark of Digilent Inc.

MAX31723PMB1 Peripheral Module

Component List

DESIGNATION	QTY	DESCRIPTION
C1	1	0.1 μ F \pm 10%, 16V X7R ceramic capacitor (0603) Murata GRM188R71C104KA01D
C2	1	1 μ F \pm 10%, 10V X7R ceramic capacitor (0603) TDK C1608X7R1A105K
J1	1	6-pin right-angle male header
JP1	1	10-pin (2 x 5) straight male header

DESIGNATION	QTY	DESCRIPTION
R1–R4	4	150 Ω \pm 5% resistors (0603)
R5	1	4.7k Ω \pm 5% resistor (0603)
R6	1	10k Ω \pm 5% resistor (0603)
U1	1	Digital thermometer and thermostat (8 μ MAX [®]) Maxim MAX31723MUA+
—	3	Shorting jumpers
—	1	PCB: EPCB31723PM1

Component Suppliers

SUPPLIER	PHONE	WEBSITE
Murata Electronics North America, Inc.	770-436-1300	www.murata-northamerica.com
TDK Corp.	847-803-6100	www.component.tdk.com

Note: Indicate that you are using the MAX31723PMB1 when contacting these component suppliers

Detailed Description

SPI/3-Wire Interface

The MAX31723PMB1 peripheral module can plug directly into a Pmod-compatible port (configured for SPI/3-wire) through connector J1. For information on SPI and 3-wire protocols, refer to the MAX31723 IC data sheet. The user selects between SPI and 3-wire communication protocols by setting the correct jumper configuration on JP2. See Figure 1 for proper jumper settings.

Connector J1 provides connection of the module to the Pmod host. The pin functions and pin assignments adhere to the Pmod standard recommended by Digilent. Note that when this module is operating in 3-wire mode, the host-side interface must be configured as GPIO to allow for bit-banged communication. 3-wire mode has the advantage of freeing up an interface pin on the IC to allow for connection to the thermostat/alarm output. See Table 1.

The JP1 jumper block is used to configure the communication mode with the host board. The peripheral module can communicate in either SPI or 3-wire mode. The correct shunt settings are shown in Table 2 and Figure 1.

Table 1. Connector J1 (SPI/3-Wire Communication)

PIN	SIGNAL	DESCRIPTION
1	SS	Chip enable. Must be asserted high for communication to take place for either the SPI or 3-wire interface.
2	MOSI	When SPI communication is selected, this pin is the serial-data input for the IC. When 3-wire communication is selected, this pin carries bidirectional data between the host and the IC.
3	MISO	When SPI communication is selected, this pin is the serial-data output for the IC. When 3-wire communication is selected, this pin carries the IC $\overline{\text{TOUT}}$ signal.
4	SCK	Serial clock. Used to synchronize data movement on the serial interface for either the SPI or 3-wire interface.
5	GND	Ground
6	VCC	Power supply

μ MAX is a registered trademark of Maxim Integrated Products, Inc.

MAX31723PMB1 Peripheral Module

Table 2. Connector JP1 (Serial-Bus Type Selection)

SHUNT	SPI MODE	3-WIRE MODE
1	3-5	1-2
2	4-6	3-5
3	9-10	4-6

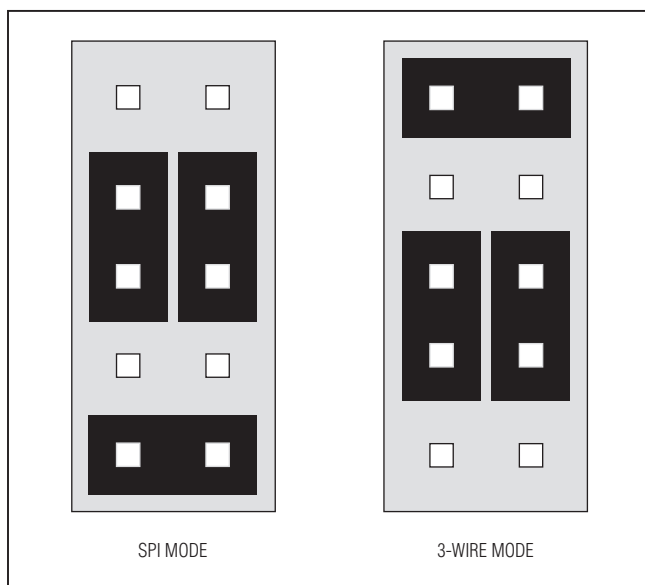

Figure 1. JP1 Jumper Settings

Software and FPGA Code

Example software and drivers are available that execute directly without modification on several FPGA development boards that support an integrated or synthesized microprocessor. These boards include the Digilent Nexys 3, Avnet LX9, and Avnet ZEDBoard, although other platforms can be added over time. Maxim provides complete Xilinx ISE projects containing HDL, Platform Studio, and SDK projects. In addition, a synthesized bit stream, ready for FPGA download, is provided for the demonstration application.

The software project (for the SDK) contains several source files intended to accelerate customer evaluation and design. These include a base application (`maximModules.c`) that demonstrates module functionality and uses an API interface (`maximDeviceSpecificUtilities.c`) to set and access Maxim device functions within a specific module.

The source code is written in standard ANSI C format, and all API documentation including theory/operation, register description, and function prototypes are documented in the API interface file (`maximDeviceSpecificUtilities.h` & `.c`).

The complete software kit is available for download at www.maxim-ic.com. Quick start instructions are also available as a separate document.

MAX31723PMB1 Peripheral Module

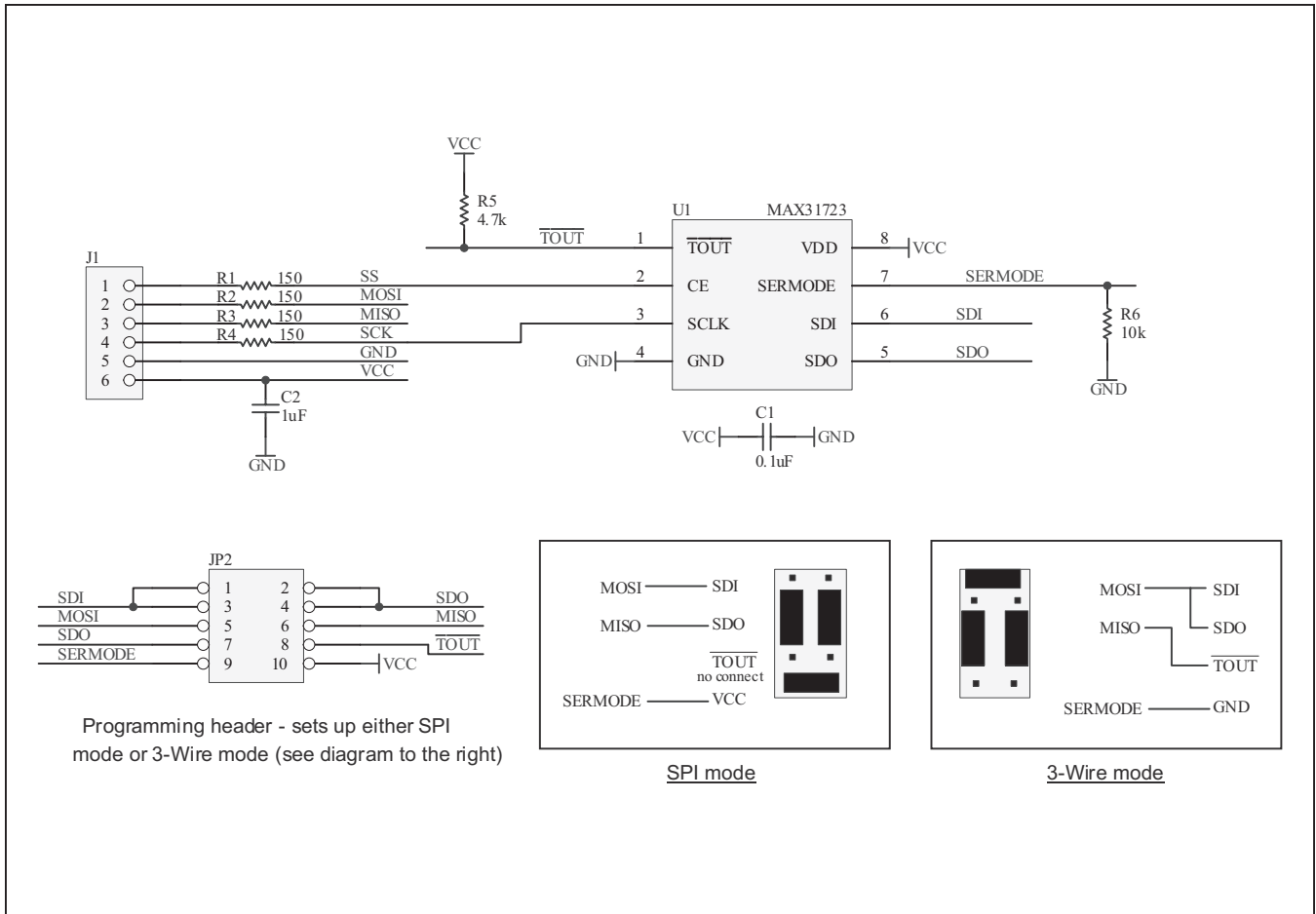

Figure 2. MAX31723PMB1 Peripheral Module Schematic

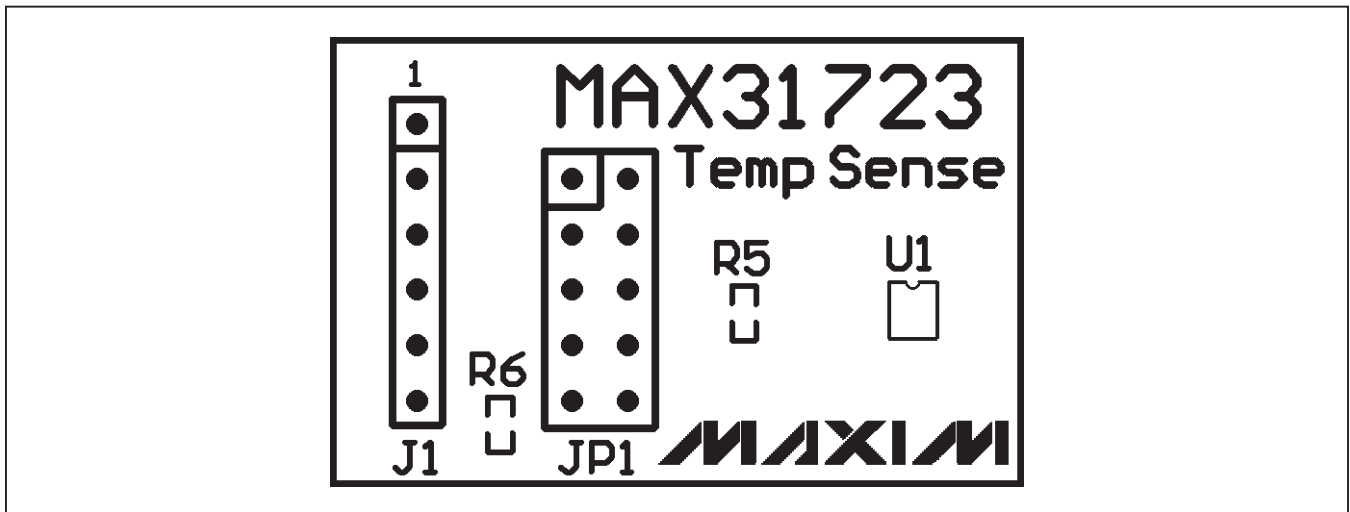

Figure 3. MAX31723PMB1 Peripheral Module Component Placement Guide—Component Side

MAX31723PMB1 Peripheral Module

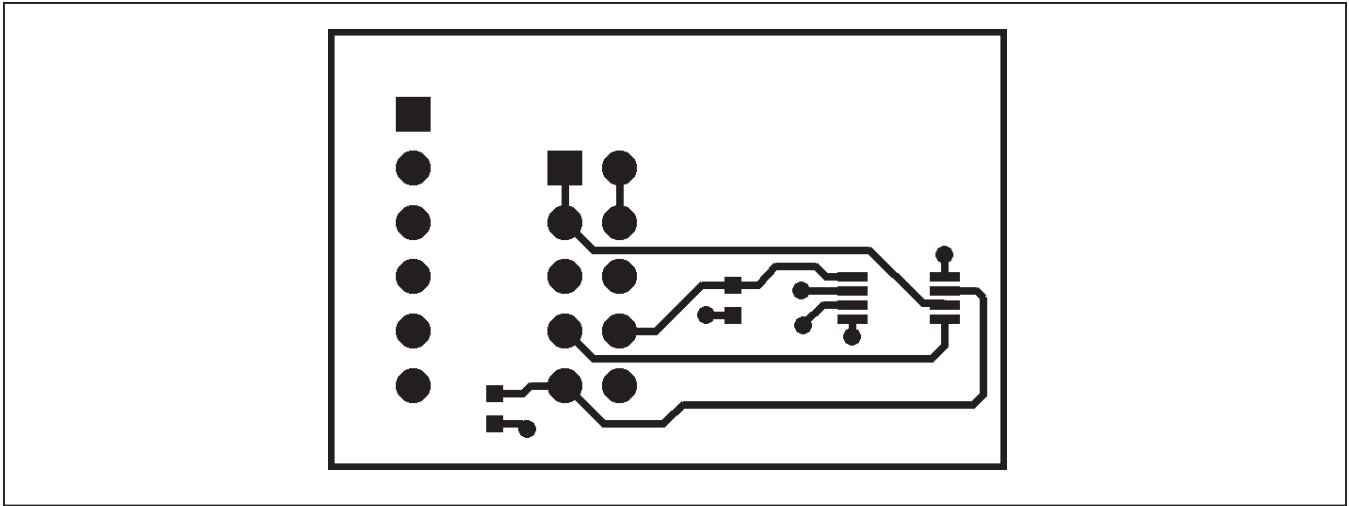

Figure 4. MAX31723PMB1 Peripheral Module PCB Layout—Component Side

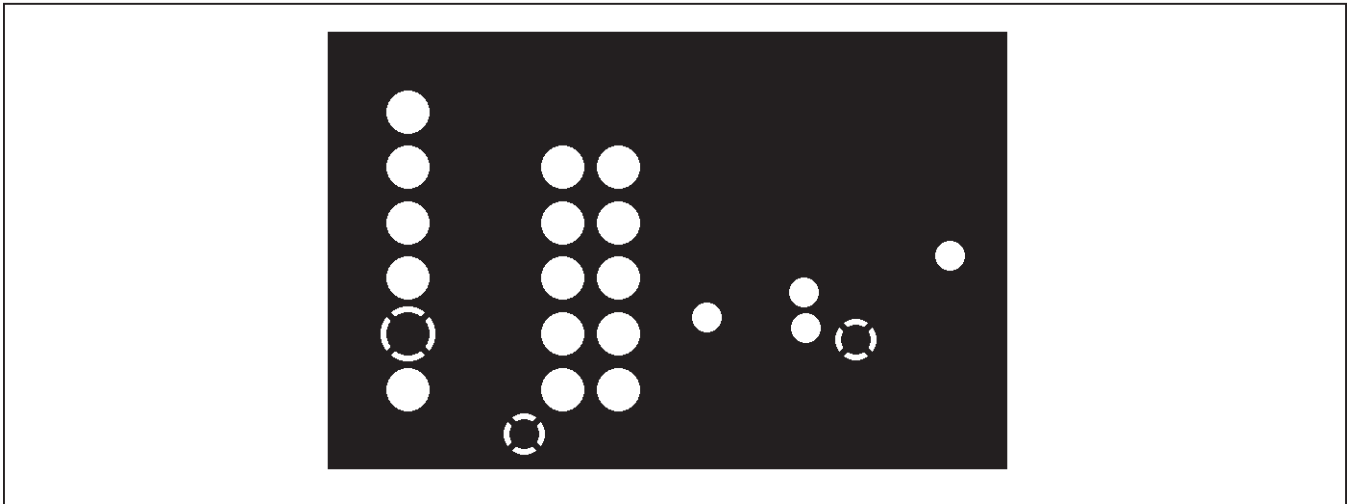

Figure 5. MAX31723PMB1 Peripheral Module PCB Layout—Inner Layer 1 (Ground)

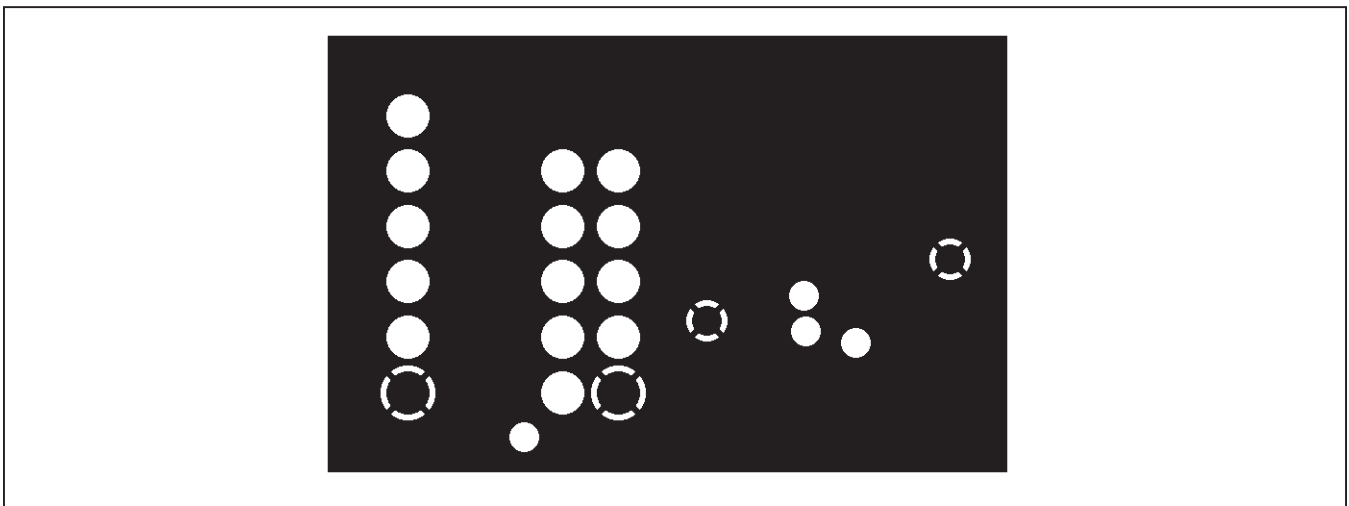

Figure 6. MAX31723PMB1 Peripheral Module PCB Layout—Inner Layer 2 (Power)

MAX31723PMB1 Peripheral Module

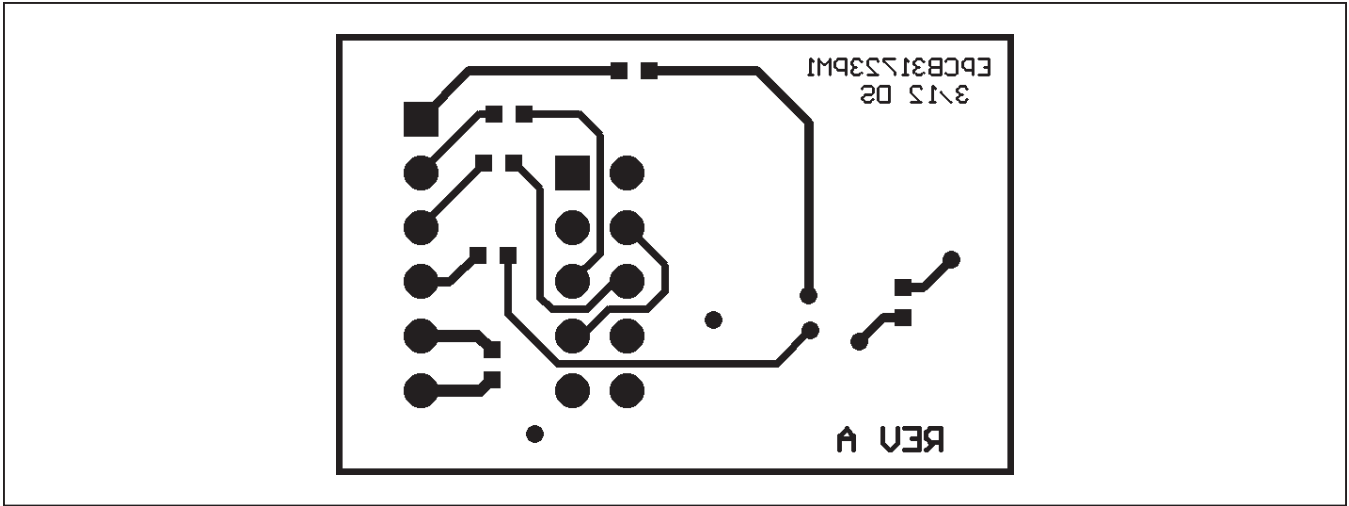

Figure 7. MAX31723PMB1 Peripheral Module PCB Layout—Solder Side

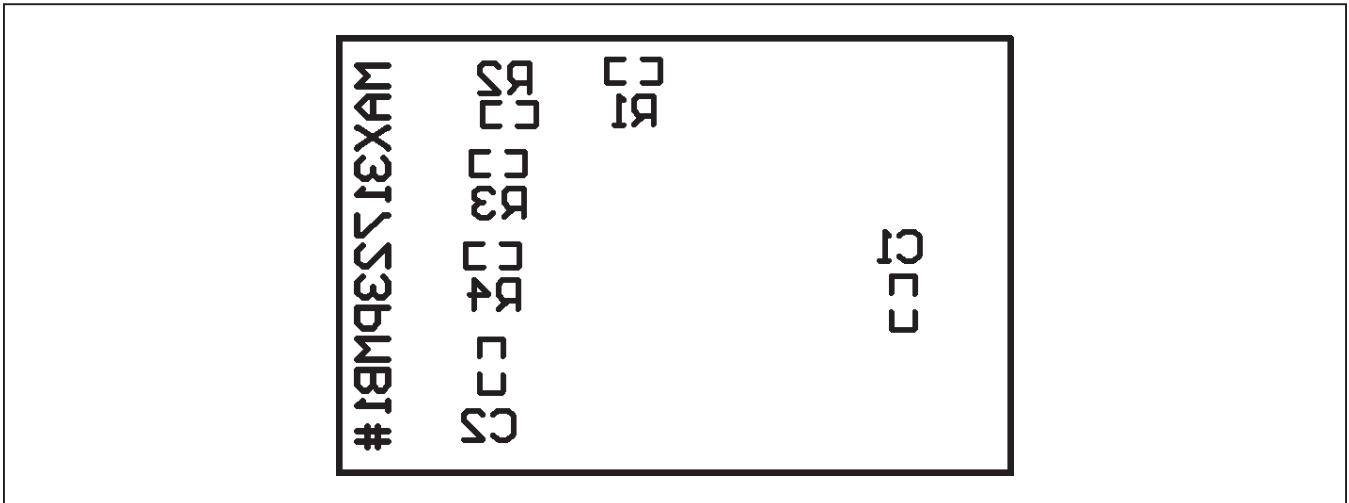

Figure 8. MAX31723PMB1 Peripheral Module Component Placement Guide—Solder Side

MAX31723PMB1 Peripheral Module

Ordering Information

PART	TYPE
MAX31723PMB1#	Peripheral Module

#Denotes RoHS compliant.

MAX31723PMB1 Peripheral Module

Revision History

REVISION NUMBER	REVISION DATE	DESCRIPTION	PAGES CHANGED
0	5/12	Initial release	—

Maxim cannot assume responsibility for use of any circuitry other than circuitry entirely embodied in a Maxim product. No circuit patent licenses are implied. Maxim reserves the right to change the circuitry and specifications without notice at any time.

Maxim Integrated Products, 120 San Gabriel Drive, Sunnyvale, CA 94086 408-737-7600 _____ 8

X-ON Electronics

Largest Supplier of Electrical and Electronic Components

Click to view similar products for [Temperature Sensor Development Tools](#) category:

Click to view products by [Maxim](#) manufacturer:

Other Similar products are found below :

[EVAL-ADT75EBZ](#) [T20321SS2B](#) [T2016P2CRRXC4S2](#) [DC2507A](#) [MAX1617AEVKIT](#) [BB-WSK-REF-2](#) [MCP9800DM-TS1](#) [TMPSNSRD-RTD2](#) [MIKROE-2273](#) [MIKROE-2539](#) [MIKROE-2554](#) [DPP201Z000](#) [DPP901Z000](#) [1899](#) [EV-BUNCH-WSN-2Z](#) [DPP904R000](#) [KIT0021](#) [SEN0206](#) [SEN0227](#) [MIKROE-2769](#) [SEN-13314](#) [SEN0137](#) [3328](#) [DC1785B](#) [MHUM-01](#) [3538](#) [DPP201G000](#) [DFR0066](#) [WPP100B009](#) [393](#) [SDT310LTC100A3850](#) [SI7005EVB-UDP-M3L1](#) [2857](#) [1782](#) [2652](#) [269](#) [3245](#) [3622](#) [3648](#) [3721](#) [4089](#) [4101](#) [4369](#) [4566](#) [4636](#) [4808](#) [4821](#) [AS6200C-WL_EK_AB](#) [AS6200-WL_DK_ST](#) [AS6200-WL_EK_AB](#)