

MAX32650/MAX32651 Evaluation Kits

Evaluate: MAX32650–MAX32652

General Description

The MAX32650/MAX32651 EV kits provide a platform for evaluating the capabilities of the MAX32650/MAX32651 ultra-low power memory-scalable microcontroller designed specifically for high performance battery powered applications.

EV Kit Contents

- MAX32650 EV kit containing a MAX32650/MAX32651 with a preprogrammed demo
- JTAG debugger with ribbon cable
- Two standard A to Micro B USB cables

Ordering Information

PART	TYPE	SECURE
MAX32650-EVKIT#	EV Kit	No
MAX32651-EVKIT#	EV Kit	Yes

#Denotes RoHS compliant.

Features

- 3.5in 320 x 240 Color TFT Display
- 64MB HyperRAM
- 64MB XIP Flash
- 1MB XIP RAM
- USB 2.0 Micro B Interface
- USB 2.0 Micro B to Serial UARTs
 - Selection with Jumpers Between UART0 and UART2
- Micro SD Card Interface
- Select GPIOs Accessed through 0.1in Header
- Access to the Four Analog Input Through 0.1in Header
- Arm® or SWD JTAG 20-Pin Header
- On-Board PMIC to Source Power for the MAX32650/MAX32651
- Board Power Provided by Either USB Port
- Individual Power Measurement on All IC Rails Through Jumpers
- On-Board 1.8V and 3.3V Regulators for Peripherals
- Two General-Purpose LEDs and Two General-Purpose Pushbutton Switches

Arm is a registered trademark of Arm Limited (or its subsidiaries) in the US and/or elsewhere.



MAX32650 EV Kit Board

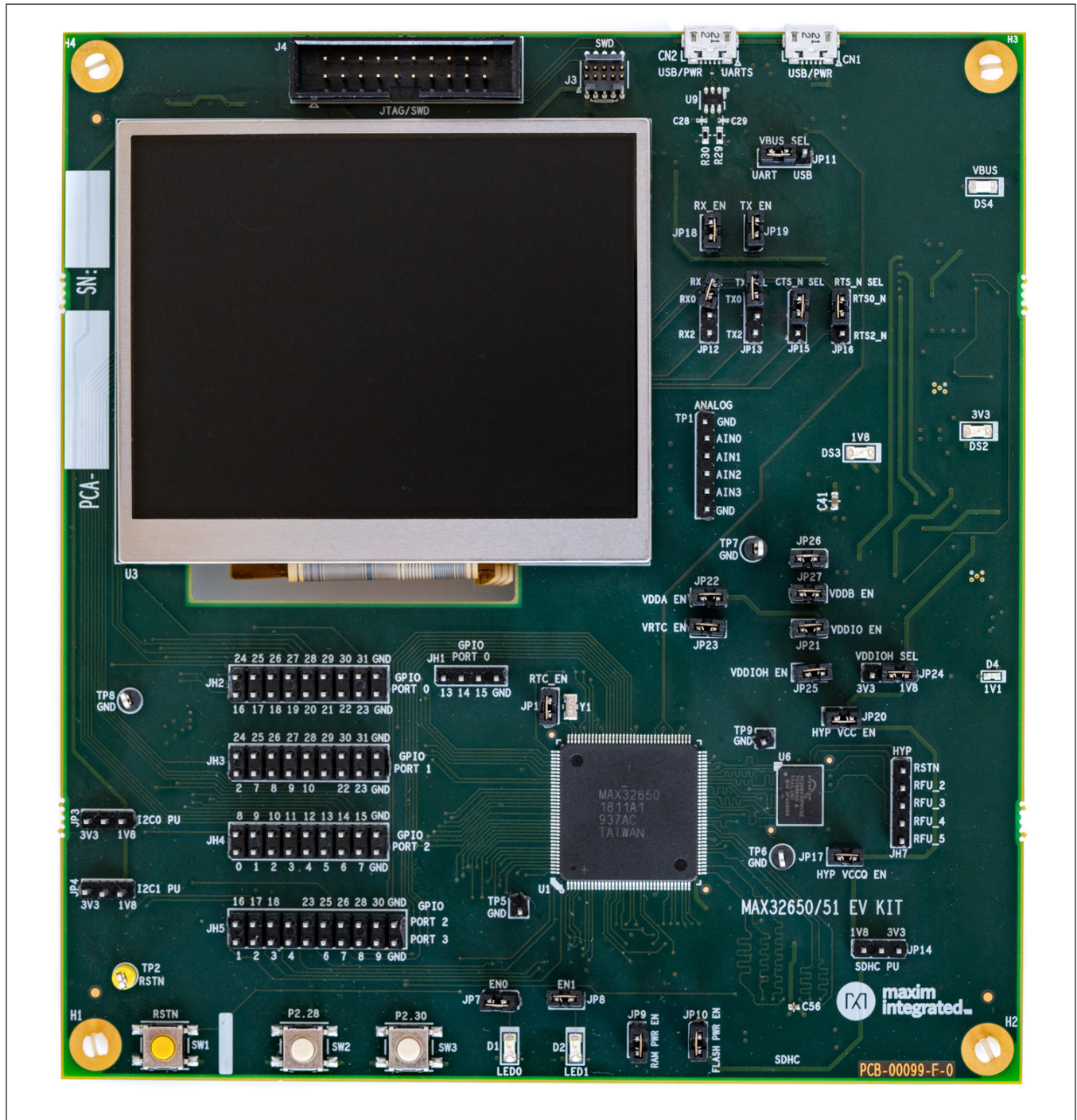

Quick Start

Procedure

Follow the steps below to verify board operation:

- 1) While observing safe ESD practices, carefully remove the MAX32650/MAX32651 EV kit board out of its packaging. Quickly inspect the board to ensure that no damage occurred during shipment. Jumpers/shunts are pre-installed prior to testing and packaging.
- 2) The MAX32650/MAX32651 is preprogrammed with a demo program. To power up the board and run the demo. Verify that the board is powered up by observing that the blue LED (DS3) and the green LEDs (DS1 and DS2) are illuminated.
- 3) Once power is applied, the demo initiates and displays the Maxim logo upon successful completion.

Detailed Description of Hardware

Power Supply

The EV kit is powered by +5V and is made available through VBUS on the Micro-USB type-B connectors CN1 or CN2. The board is default jumpered for power provided by CN1. A blue LED (DS3) illuminates when the board is powered. Green LEDs DS1 and DS2 illuminate when the 1V8 and 3V3 LDOs are powered, respectively. These are dedicated for sourcing power to the board peripherals.

Current Monitoring

Jumpers provide convenient current monitoring points for VRTC (J6), VDDIO (J7), VDDIOH (J8 or J11), VCORE (J9), VDDDB (J10) and VDDA (J12).

Clocking

The IC nominally operates from an internal oscillator of 120MHz. Three other lower frequency oscillators can be selected depending on power needs. There is an internal 32.768 oscillator that requires an external 32.768kHz crystal (Y1), for accurate RTC timekeeping and USB operation.

Color TFT Display

The display provided is a 3.5in 320 x 240 color TFT. It has three-wire serial control, a 24-bit parallel RGB interface with a white LED backlight.

Universal Serial Bus

A USB Micro B connector (CN1) is provided for prototyping USB slave applications. The USB 2.0 full-speed interface (480Mbps) transceiver is embedded in the MAX32650.

UART Interfaces

The EV kit provides a USB-to-UART bridge chip, FTDI FT230X. This bridge eliminates the requirement for a physical RS-232 COM port. Instead, the IC's UART access is through the Micro-USB type-B connector, CN2. The USB-to-UART bridge can be connected to UART 0 or UART 2 of the IC with jumpers JP12 (RX), JP13 (TX), JP15 (CTS), and JP16 (RTS). Virtual COM port drivers and guides for installing Windows® drivers are available at the FTDI chip website.

Boot Loader GPIO Select (MAX32651 Only)

Secure boot loader GPIO pins and their PU/PD states can be selected through JP1 and JP2, respectively. GPIO selections are P2.18 (default) and P2.28 (legacy). If a different GPIO is required, pull the shunt on JP1 and connect a jumper wire between its center pin and the desired pin on the GPIO header.

Note: JP4 determines the pullup voltage level for I2C1_SCL. Since I2C1_SCL is shared with boot loader pin P2.18, it cannot be a logic high for normal operation at power up since this would cause the device to enter boot loader mode. For normal operation, the jumper on JP4 (I2C1 PU) is not populated by default and JP2, which determines if the selected boot loader pin is pulled high or low, is low (default).

Once the board is powered up, JP2 can be removed and JP4 can be populated to select the I2C pullup voltage. However, JP2 and JP4 would have to be set back to their default values if the board is reset or power is cycled. A way around this is to reprogram the boot loader pin polarity one time to override the MAX32651 default value.

Windows is a registered trademark and registered service mark of Microsoft Corporation.

Arm JTAG Connectors

The Arm standard 20-pin connector pinout is provided by shrouded header J4. JH6 is provided as an optional debugging access point, it is not populated by default. The JTAG debugger is supplied with the EV kit. JTAG logic levels are fixed to VDDIO (1.8V).

JTAG Serial Wire Debug (SWD) Support

SWD is supported by the IC and this EV kit. The port shares its clock (SWCLK) with JTAG TCK and a bidirectional data pin (SWDIO) is shared with JTAG TMS.

Reset Pushbutton

Pushbutton SW3 manually resets the MAX32650/MAX32651.

Indicator LEDs

The indicator LEDs D1 (red) and D2 (green) are connected to GPIO P2.25 and P2.26, respectively. The GPIOs need to be configured for 3.3V or open drain since they are sourced at 3.3V.

GPIO Pushbuttons

The two pushbuttons (SW2 and SW3) are connected to GPIO P2.28 and P2.30, respectively. If the pushbutton is pressed, the attached port pin is pulled low.

GPIO Headers

Select GPIOs are accessible through a 0.1in spaced header pins. The IC provides support for both 1.8V and 3.3V peripherals through power rails VDDIO and VDDIOH. GPIO voltages can be programmed on pin-by-pin basis. Refer to the IC's operating guide for more detail.

Table 1. Jumper Settings

JUMPER	SIGNAL	SETTINGS	DESCRIPTION
JP1	P2_18	2-1*	Connects P2_18 to PU or PD resistor on JP2 (MAX32651 only)
	P2_28	2-3	Connects P2_28 to PU or PD resistor on JP2 (MAX32651 only)
JP2	P2_18 or P2_28	2-1	Pulls up GPIO P2_18 or P2_28, depending on JP1 setting (MAX32651 only)
		2-3*	Pulls down GPIO P2_18 or P2_28, depending on JP1 setting (MAX32651 only)
JP3	P2_8	2-1*	Connects 1.8V pullup to P2_8 (I2C0 SCL)
		2-3	Connects 3.3V pullup to P2_8 (I2C0 SCL)
JP4	P2.18	2-1	Connects 1.8V pullup to P2_18 (I2C1 SCL)
		2-3	Connects 3.3V pullup to P2_18 (I2C1 SCL)
JP5	P2_7	2-1*	Connects 1.8V pullup to P2_7 (I2C0 SDA)
		2-3	Connects 3.3V pullup to P2_7 (I2C0 SDA)
JP6	P2_17	2-1*	Connects 1.8V pullup to P2_17 (I2C1 SDA)
		2-3	Connects 3.3V pullup to P2_17 (I2C1 SDA)
JP7	P2_25	Open	Disconnects RED LED D1 from P2_25 GPIO
		Close*	Connects RED LED D1 to P2_25 GPIO
JP8	P2_26	Open	Disconnects GREEN LED D1 from P2_26 GPIO
		Close*	Connects GREEN LED D1 to P2_26 GPIO
JP9	RAM XIP VCC	Open	Disconnects 1V8_AUX from RAM XIP VCC
		Close*	Connects 1V8_AUX to RAM XIP VCC
JP10	FLASH XIP VCC	Open	Disconnects 1V8_AUX from FLASH XIP VCC
		Close*	Connects 1V8_AUX to FLASH XIP VCC

*Denotes default setting.

Table 1. Jumper Settings (continued)

JUMPER	SIGNAL	SETTINGS	DESCRIPTION
JP11	VBUS	2-1	Connects USB port CN1 to VBUS
		2-3*	Connects USB-UART port CN2 to VBUS
JP12	JP18	2-1*	Connects TXD of USB-Serial IC to P2_11 (UART0_RX) if JP18 closed
		2-3	Connects TXD of USB-Serial IC to P1_9 (UART2_RX) if JP18 closed
JP13	JP19	2-1*	Connects RXD of USB-Serial IC to P2_12 (UART0_TX) if JP19 closed
		2-3	Connects RXD of USB-Serial IC to P1_10 (UART2_TX) if JP19 closed
JP14	SDHC PU	2-1*	Connects 1V8_AUX to the SDHC pull ups
		2-3	Connects 3V3_AUX to the SDHC pull ups
JP15	RTS_N of USB-Serial IC	2-1*	Connects RTS_N of USB-Serial IC to P2_9 (UART0_CTS_N)
		2-3	Connects RTS_N of USB-Serial IC to P1_7 (UART2_CTS_N)
JP16	CTS_N of USB-Serial IC	2-1*	Connects CTS_N of USB-Serial IC to P2_10 (UART0_RTS_N)
		2-3	Connects CTS_N of USB-Serial IC to P1_8 (UART2_RTS_N)
JP17	HyperRAM VCCQ	Open	Disconnects 1V8_AUX from HyperRAM VCCQ
		Close*	Disconnects 1V8_AUX to HyperRAM VCCQ
JP18	TXD of USB-Serial IC	Open	Disconnects TXD of USB-Serial IC from JP12 RX SEL jumper
		Close*	Connects TXD of USB-Serial IC to JP12 RX SEL jumper
JP19	RXD of USB-Serial IC	Open	Disconnects RXD of USB-Serial IC from JP13 TX SEL jumper
		Close*	Connects RXD of USB-Serial IC to JP13 TX SEL jumper
JP20	HyperRAM VCC	Open	Disconnects 1V8_AUX from HyperRAM VCC
		Close*	Connects 1V8_AUX to HyperRAM VCC
JP21	VDDIO	Open	Disconnects 1V8 from VDDIO
		Close*	Connects 1V8 to VDDIO
JP22	VDDA	Open	Disconnects 1V8 from VDDA
		Close*	Connects 1V8 to VDDA
JP23	VRTC	Open	Disconnects 1V8 from VRTC
		Close*	Connects 1V8 to VRTC
JP24	JP25	2-1	Connects 1V8 to VDDIOH when JP25 is closed
		2-3*	Connects 3V3 to VDDIOH when JP25 is closed
JP25	VDDIOH	Open	Disconnects power from VDDIOH
		Close*	Connects power to VDDIOH
JP26	VCORE	Open	Disconnects 1V1 from VCORE
		Close*	Connects 1V1 to VCORE
JP27	VDDB	Open	Disconnects 3V3 from VDDB
		Close*	Connects 3V3 to VDDB

*Denotes default setting.

MAX32650 EV Kit Bill of Materials

QTY	PART REFERENCE	VALUE	BOM DESCRIPTION	MMANUFACTURER PN	MANUFACTURER
6	C1 C3 C4 C6 C7 C8	1uF	CAP CER 1UF 6.3V 10% X5R 0402	JMK105BJ105KV-F	Taiyo Yuden
4	C2 C5 C9 C10	150pF	CAP CER 150PF 50V 5% C0G 0603	C1608C0G1H151J080AA	TDK Corporation
4	C11 C30 C41 C57	4.7uF	CAP CER 4.7uF 10V 10% X5R 0603	C0603C475K8PACTU	Kemet
7	C12 C14 C20 C21 C39 C42 C46	1uF	CAP CER 1uF 16V 10% X7R 0603	GCM188R71C105KA64D	Murata
1	C13	10pF	CAP CER 10pF 50V 5% NPO 0603	06035A100JAT2A	AUX
13	C15 C16 C17 C18 C19 C22 C23 C26 C31 C34 C37 C45 C56	100nF	CAP CER 0.1UF 10V 10% X5R 0402	GRM155R61A104KA01D	Murata Electronics
3	C24 C32 C55	100nF	CAP CER 0.1UF 25V 10% X8R 0603	C1608X8R1E104K080AA	TDK Corporation
1	C25	1uF	CAP CER 1UF 35V 10% X5R 0603	GMK107BJ105KA-T	Taiyo Yuden
1	C27	10nF	CAP CER 10000PF 25V 10% X7R 0603	CL10B103KA8NNNC	Samsung
2	C28 C29	47pF	CAP CER 47PF 50V 1% NPO 0402	C1005C0G1H470F050BA	TDK Corporation
1	C33	100nF	CAP CER 0.1uF 16V 10% X7R 0603	C0603C104K4RACTU	Kemet
2	C35 C47	10uF	CAP CER 10UF 10V 10% X7R 0805	CL21B106KQNNNE	Samsung
1	C36	10uF	CAP CER 10UF 6.3V 20% X5R 0402	GRJ155R60J106ME11D	Murata Electronics
2	C38 C40	8pF	CAP CER 8PF 50V NPO +/-0.25pF 0402	CC0402CRNPO9BN8R0	Yageo
1	C44	4.7uF	CAP CER 4.7UF 4V 20% X5R 0402	AMK105BJ475MV-F	Taiyo Yuden
2	CN1 CN2	MICRO USB B R/A	CONN RCPT 5POS MICRO USB B R/A	47346-0001	Molex
1	D1	RED	LED 660NM RED WTR CLR 1206 SMD	SML-LX1206SRC-TR	Lumex Opto
3	D2 DS2 DS3	GRN	LED 565NM WTR CLR GREEN 1206 SMD	SML-LX1206GC-TR	Lumex Opto
1	D3	CMOSH-3	Schottky Diode 30V_100mA	CMOSH-3	Central Semiconductor
1	D4	GRN	LED SMARTLED GREEN 570NM 0603	LG L29K-G2J1-24-Z	OSRAM Opto
1	DS4	BLUE	LED 469NM BLUE DIFF 1206 SMD	HSMR-C150	Avago Technologies
4	H1 H2 H3 H4	DNI	DNI MTG 125DRL 300PAD		
1	J1	047571-0001	CONN MICRO SD CARD PUSH-PULL R/A	047571-0001	Molex
1	J2	54P 0.5mm	CONN FFC/FPC 54POS ZIF .5MM SMD	0512965494	Molex Inc
1	J3	10P CORTEX DEBUG	CONN HEADER 10POS DUAL .05" SMD	FTSH-105-01-F-DV-K	Samtec
1	J4	20P 10x2	CONN HEADER 2.54MM 20POS GOLD	SBH11-PBPC-D10-ST-BK	Sullins
1	JH1	4P 1x4	CONN HEADER .100 SINGL STR 4POS	PEC04SAAN	Sullins
3	JH2 JH3 JH4	18P 2x9	CONN HEADER .100 DUAL STR 18POS	PEC09DAAN	Sullins
1	JH5	20P 2x10	CONN HEADER .100 DUAL STR 20POS	PEC10DAAN	Sullins
1	JH7	5P 1x5	CONN HEADER .100 SINGL STR 5POS	PEC05SAAN	Sullins
11	JP3 JP4 JP5 JP6 JP11 JP12 JP13 JP14 JP15 JP16 JP24	3P 3x1	CONN HEADER .100 SINGL STR 3POS	PEC03SAAN	Sullins
14	JP7 JP8 JP9 JP10 JP17 JP18 JP19 JP20 JP21 JP22 JP23 JP25 JP26 JP27	JUMPER	CONN HEADER .100 SINGL STR 2POS	PEC02SAAN	Sullins
2	JP1* JP2*	3P 3x1	CONN HEADER .100 SINGL STR 3POS	PEC03SAAN	Sullins

*MAX32651 EV Kit

MAX32650/MAX32651
Evaluation Kits

Evaluate: MAX32650–MAX32652

MAX32650 EV Kit Bill of Materials (continued)

QTY	PART REFERENCE	VALUE	BOM DESCRIPTION	MMANUFACTURER PN	MANUFACTURER
1	L1	22uH	FIXED IND 22UH 1.9A 105MOHM SMD	VLS6045EX-220M-H	TDK Corporation
2	L2 L4	HZ1206C202R-10	FERRITE CHIP SIGNAL 2000 OHM SMD	HZ1206C202R-10	Laird-Signal Integrity
1	L3	BLM21PG221SN1D	FERRITE CHIP 220 OHM 0805	BLM21PG221SN1D	Murata Electronics
1	PCB1	PCB			
2	Q1 Q3	BSS806N	MOSFET N-CH 20V 2.3A SOT23	BSS806N H6327	Infineon Technologies
1	Q2	SSM3J327R,LF	MOSFET P-CH 20V 6A SOT23F	SSM3J327R,LF	Toshiba Semiconductor
19	R1 R10 R11 R12 R13 R14 R15 R16 R17 R18 R19 R20 R21 R25 R28 R31 R32 R39 R53	10K	RES 10K OHM 1/10W 1% 0603 SMD	ERJ-3EKF1002V	Panasonic
4	R2 R4 R6 R8	33.2	RES 33.2 OHM 1/10W 1% 0603 SMD	ERJ-3EKF33R2V	Panasonic
4	R3 R5 R7 R9	49.9	RES 49.9 OHM 1/10W 1% 0603 SMD	ERJ-3EKF49R9V	Panasonic
1	R22	470	RES 470 OHM 1/10W 1% 0603 SMD	ERJ-3EKF4700V	Panasonic
3	R23 R34 R41	332	RES 332 OHM 1/10W 1% 0603 SMD	ERJ-3EKF3320V	Panasonic
1	R24	137K	RES SMD 137K OHM 1% 1/10W 0603	ERJ-3EKF1373V	Panasonic
1	R26	10K	RES 10K OHM 1/10W 1% 0603 SMD	ERJ-3EKF1002V	Panasonic
1	R27	1M	RES SMD 1M OHM 5% 1/8W 0805	ERJ-6GEYJ105V	Panasonic
2	R29 R30	27	RES 27 OHM 1/10W 1% 0603 SMD	ERJ-3EKF27R0V	Panasonic
2	R33 R45	1K	RES 1K OHM 1/10W 1% 0603 SMD	ERJ-3EKF1001V	Panasonic
5	R35 R36 R37 R38 R40	DNI	DNI 0402		
1	R43	18.7K	RES SMD 18.7K OHM 1% 1/10W 0402	ERJ-2RKF1872X	Panasonic Electronic
1	R44	49.9K	RES 49.9K OHM 1/10W 1% 0603 SMD	ERJ-3EKF4992V	Panasonic
2	R46 R57	150K	RES 150K OHM 1/10W 1% 0603 SMD	ERJ-3EKF1503V	Panasonic
1	R48	10	RES 10 OHM 1/10W 1% 0603 SMD	ERJ-3EKF10R0V	Panasonic
2	R49 R51	0	RES SMD 0 OHM JUMPER 1/10W 0603	RC0603JR-070RL	Yageo
2	R50 R52	0	RES SMD 0 OHM JUMPER 1/10W 0603	RC0603JR-070RL	Yageo
1	R54	2.7K	RES 2.7K OHM 1/10W 1% 0603 SMD	ERJ-3EKF2701V	Panasonic
1	SW1	B3S-1002 BY OMZ	SWITCH TACTILE SPST-NO 0.05A 24V	B3S-1002 BY OMZ	Omron Electronics
2	SW2 SW3	B3S-1000P	SWITCH TACTILE SPST-NO 0.05A 24V	B3S-1000P	Omron Electronics
1	TP1	6P 1x6	CONN HEADER .100 SINGL STR 6POS	PEC06SAAN	Sullins
1	TP2	YLVW	TEST POINT PC MULTI PURPOSE YEL	5014	Keystone Electronics
2	TP5 TP9	1P	CONN HEADER .100 SINGL STR 1POS	PEC01SAAN	Sullins
3	TP6 TP7 TP8	BLK	TEST POINT PC MULTI PURPOSE BLK	5011	Keystone Electronics
1	U1*	MAX32650GCE+	MAX32650GCE+ 144P TQFP	MAX32650GCE+	Maxim Integrated
1	U1**	MAX32651GCE+	MAX32651GCE+ 144P TQFP	MAX32651GCE+	Maxim Integrated
1	U2	MAX8574EUT+T	IC CONV LCD BOOST SOT23-6	MAX8574EUT+T	Maxim Integrated
1	U3	NHD-3.5-320240MF-ATXL#-1	LCD DISP TFT 3.5" 320X240 B/L	NHD-3.5-320240MF-ATXL#-1	Newhaven Display Intl
1	U4	MX25U6435FM2I-10G	IC FLASH 64MBIT 104MHZ 8SOP	MX25U6435FM2I-10G	Macronix
1	U5	N01S818HAT22I	IC SRAM 1MBIT 20MHZ 8TSSOP	N01S818HAT22I	ON Semiconductor
1	U6	S27KS0641DPBH020	IC HYPERRAM 64Mb 24BGA 166MHz		Cypress Semiconductor
2	U7 U9	MAX3207EAUT+T	ESD PROT DIFF SOT23-6	MAX3207EAUT+T	Maxim Integrated
1	U8	FT230XS-R	IC USB SERIAL BASIC UART 16SSOP	FT230XS-R	FTDI
1	U10	MAX1806EUA33+	IC REG LDO 3.3V/ADJ 0.5A 8UMAX	MAX1806EUA33+	Maxim Integrated
1	U11	MAX1818EUT18+	IC REG LDO 1.8V/ADJ 0.5A SOT23-6	MAX1818EUT18+	Maxim Integrated
1	U12	MAX1806EUA18+	Low Dropout Linear Regulator	MAX1806EUA18+	Maxim Integrated
1	Y1	32.768kHz	CRYSTAL 32.768KHZ 6.0PF SMD	ABS07-32.768KHZ-6-T	Abracon Corp

*MAX32650 EV Kit

**MAX32651 EV Kit

MAX32650/51 EV Kit Schematics

NOTES:

REV 2.0

- 1) Moved inductor L5 to LXA instead of LXB of PMIC U12.
- 2) Swapped port 2 location with port 3 on JH5 for clearer sequencing on pcb.
- 3) Removed J11 and added JP29 (3 pin header) and JP28 (2 pin header) for VDDIOH, which allows SBB0 or SBB2 to source VDDIOH.
- 4) Removed JP14 (VIO_REF_SEL) so as to allow USB to UART bridge and JTAG IO voltages to be individually selected via resistor stuff option.

REV 3.0

- 1) Added PFET to SD card VDD to control voltage to it via GPIO P3_5.
- 2) Renamed JP31 to JP14.
- 3) Removed JP5 and combined with JP4.
- 4) Removed JP6 and combined with JP3.

REV D

- 1) Removed the PMIC U12 and replaced with LDOs.
- 2) Removed jumper JP2.
- 2) Added power sequencing IC (U13) and FETs to provide voltage sequencing to the rails of the MAX32650.

REV E

- 1) Removed the 1V8_AUX from VIN of the 1.1V LDO (U12) and connected VBUS to VIN.

REV F

- 1) Removed the power sequencing circuit on page 8 (Power). This consists of U13 (IC supervisor), its three voltage dividers and FETs Q4 through Q7. No longer required by design.

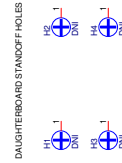

PCB1
PCB-00099-F-0

MAX32650/51 EV Kit Schematics (continued)

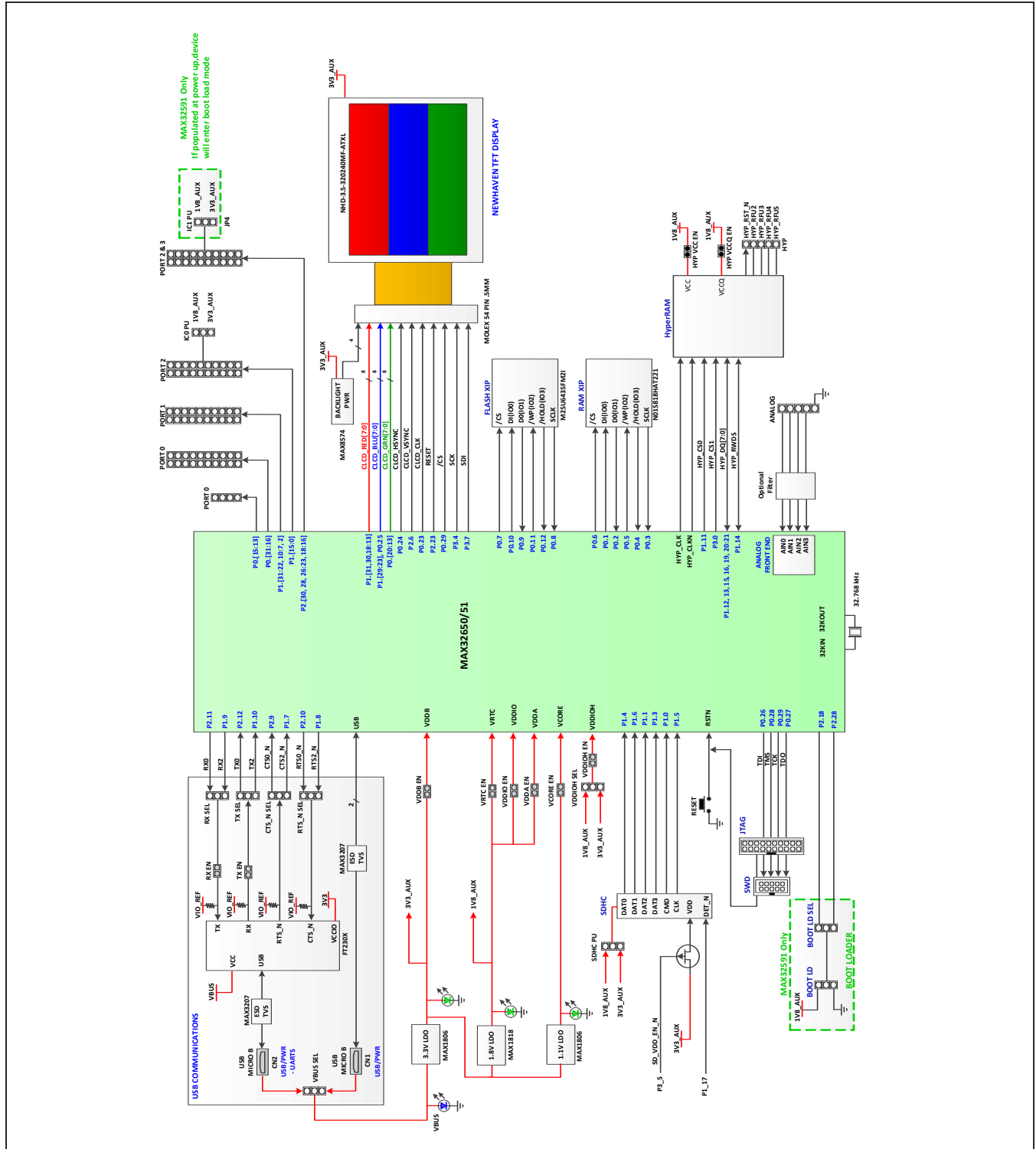

MAX32650/51 EV Kit Schematics (continued)

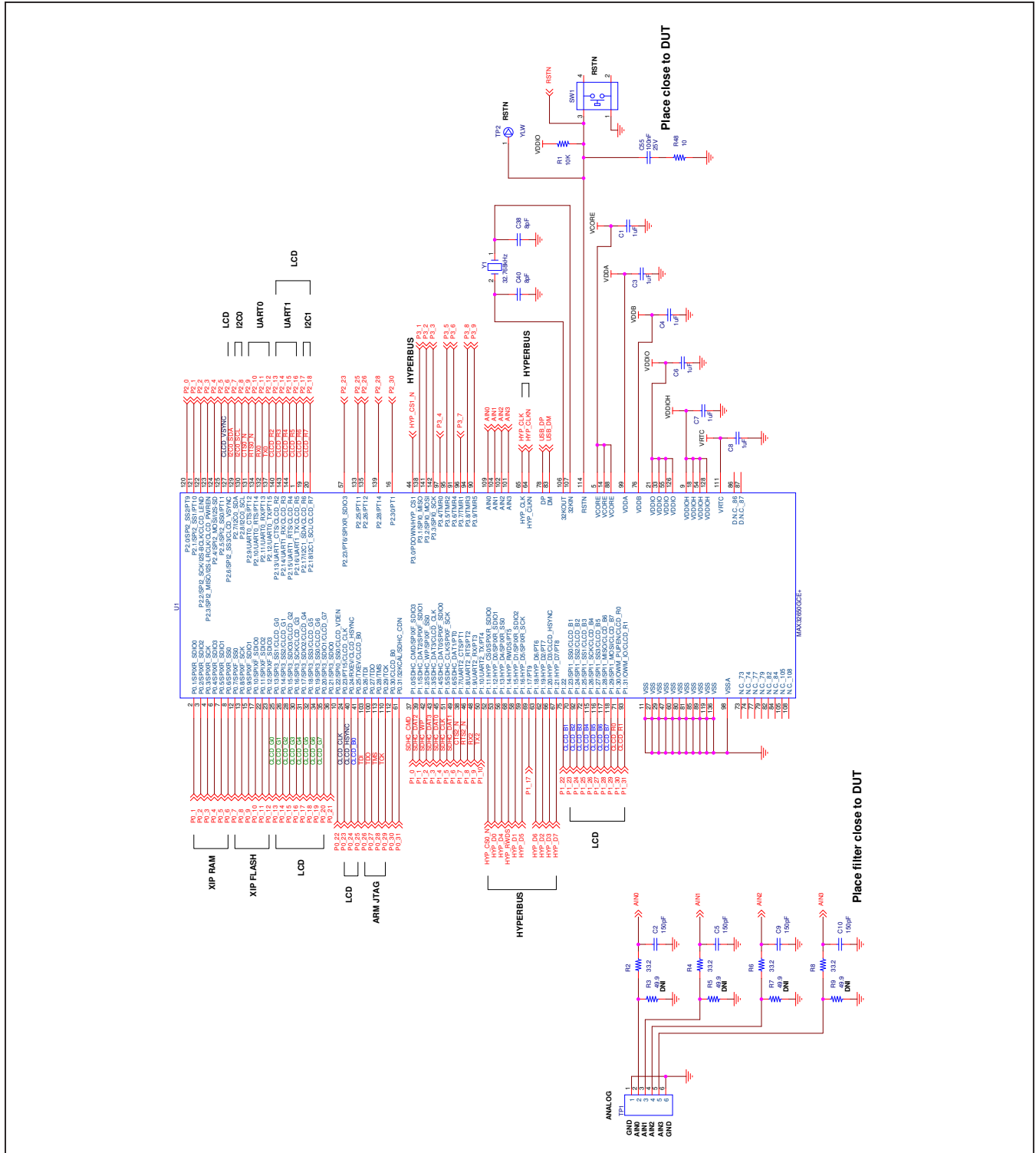

MAX32650/51 EV Kit Schematics (continued)

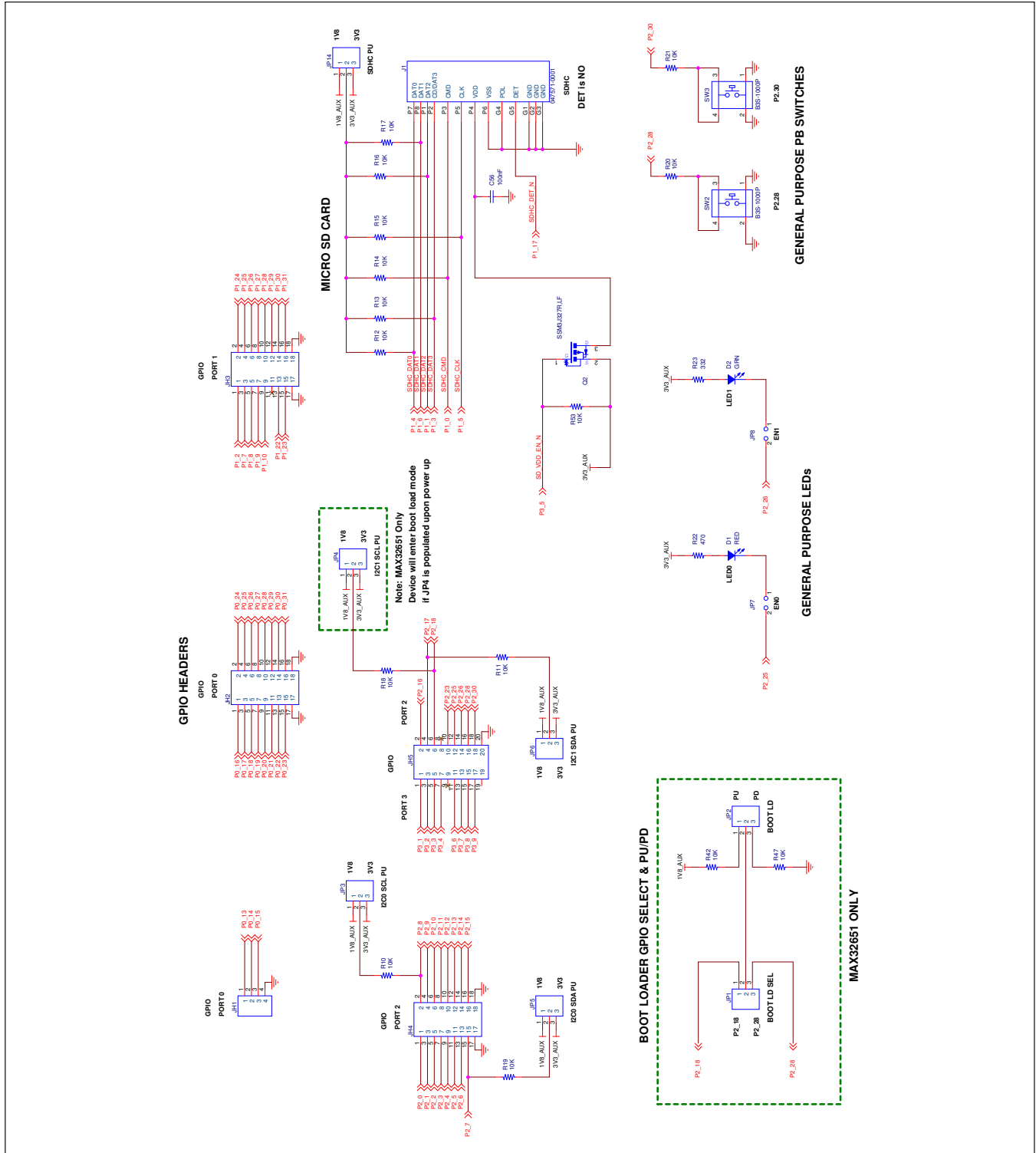

MAX32650/51 EV Kit Schematics (continued)

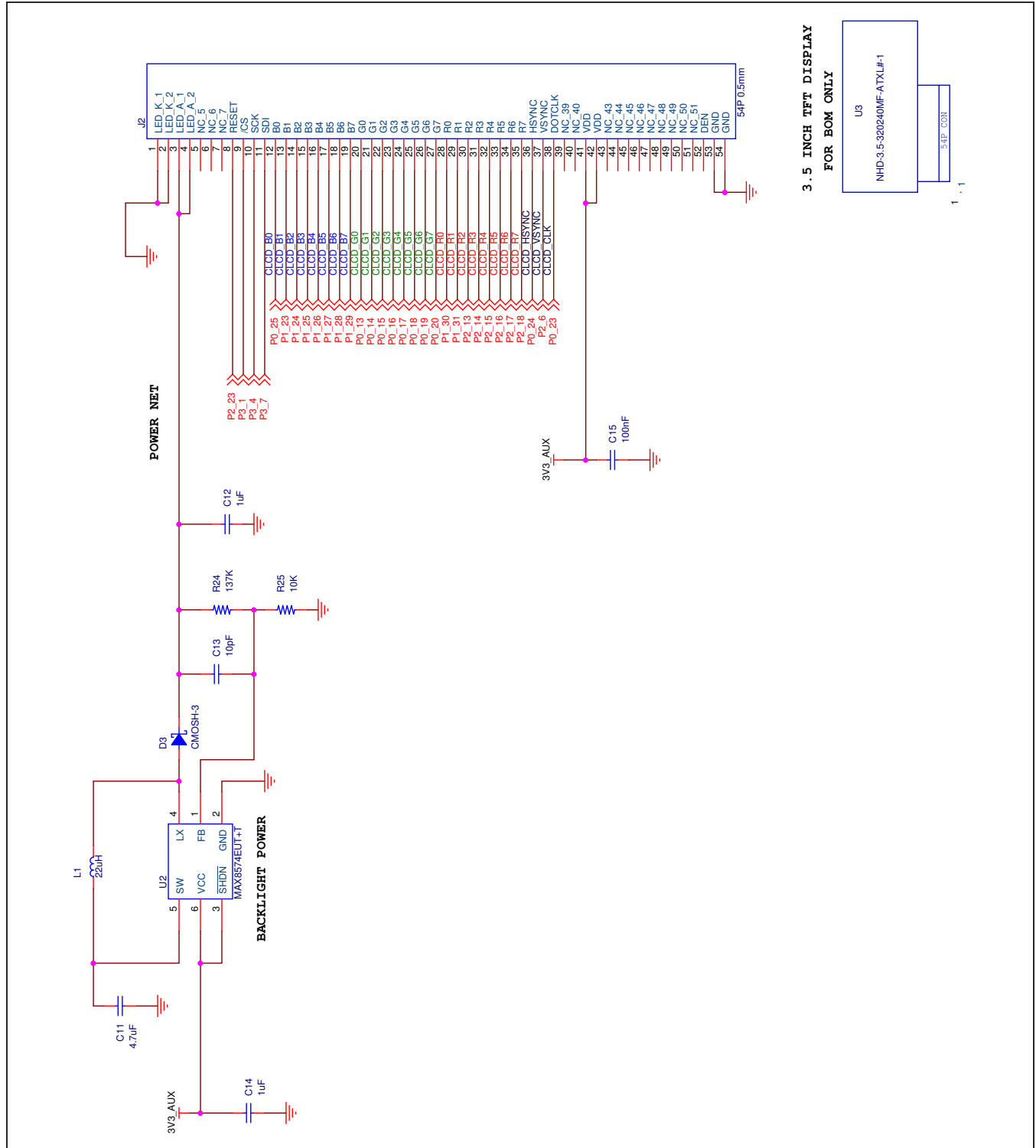

MAX32650/51 EV Kit Schematics (continued)

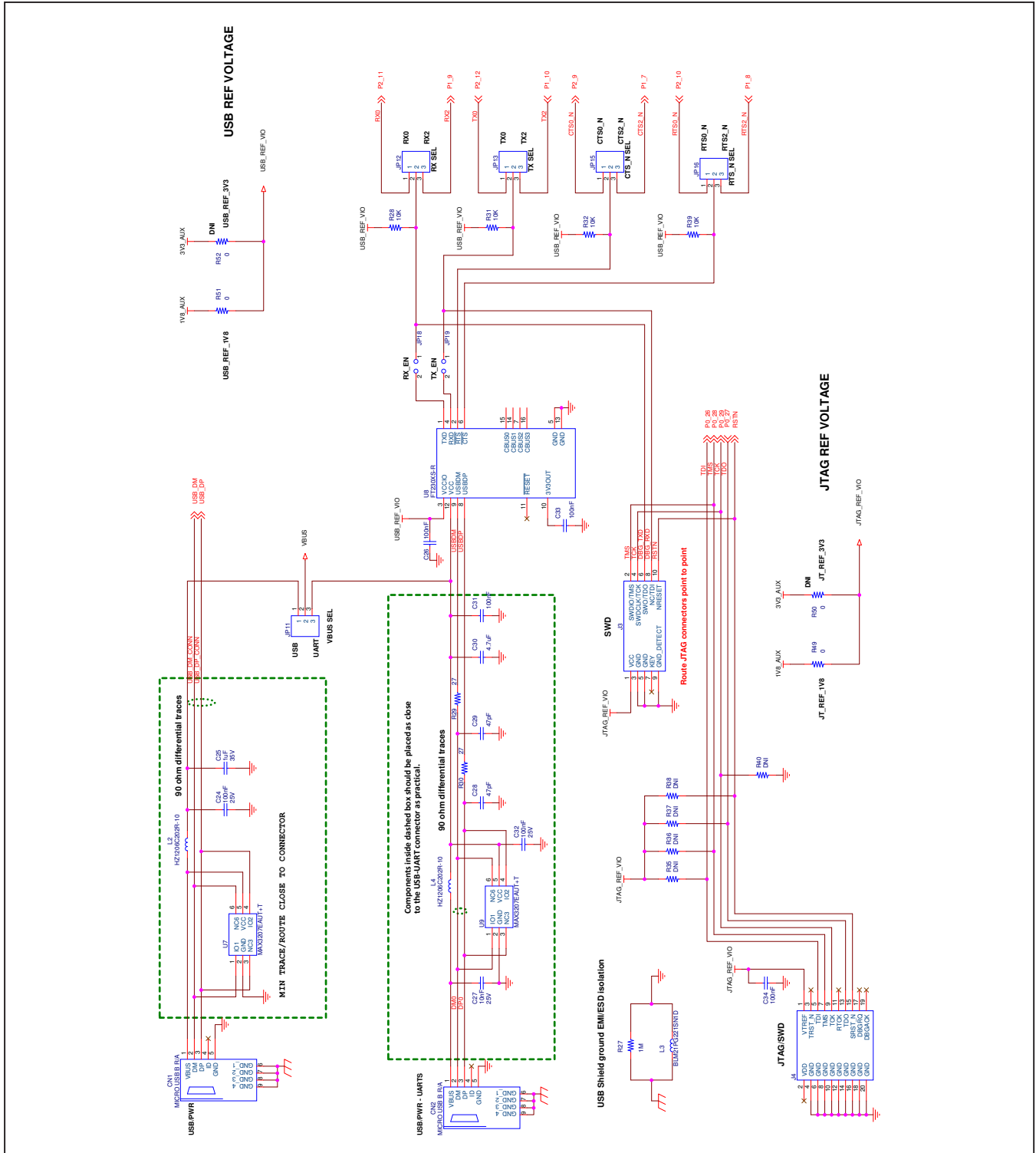

MAX32650/51 EV Kit Schematics (continued)

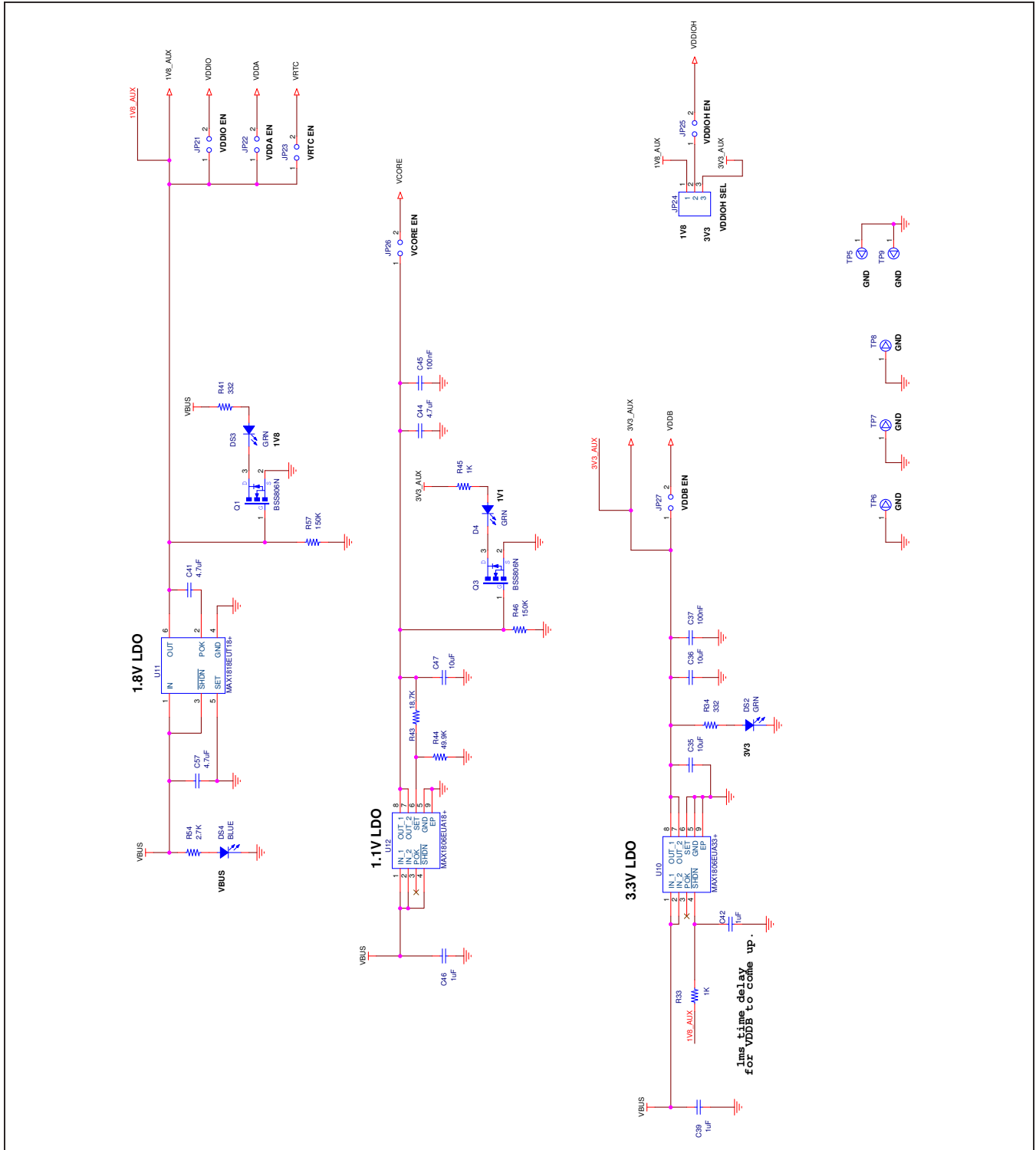

Revision History

REVISION NUMBER	REVISION DATE	DESCRIPTION	PAGES CHANGED
0	10/17	Initial release	—
1	1/18	Updated <i>MAX32650 EV Kit Board Photo, Procedure, Arm JTAG Connectors, Table 1, and MAX32650 EV Kit Bill of Materials</i> , and added <i>VIO_REF Settings</i>	2–7
2	2/18	Added MAX32651 and MAX32652 to data sheet, updated schematics	1–17
3	3/18	Updated orderable part number	1
4	9/19	Updated part number, <i>General Description, Ordering Information, Features, MAX32650 EV Kit Board, Procedure, Power Supply, Reset Pushbutton, Table 1, MAX32650 EV Kit Bill of Materials</i> , and <i>MAX32650 EV Kit Schematics</i> , and removed <i>VIO_REF Setting</i>	1–16
5	2/20	Updated <i>MAX32650 EV Kit Board, Table 1, MAX32650 EV Kit Bill of Materials</i> , and <i>MAX32650 EV Kit Schematics</i>	2, 4, 6, 8–15
6	6/20	Updated <i>MAX32650 EV Kit Board, Table 1, MAX32650 EV Kit Bill of Materials</i> , and <i>MAX32650 EV Kit Schematics</i>	2, 4, 6–15
7	9/20	Added Boot Loader GPIO Select to the <i>Detailed Description of Hardware</i> section, updated Table 1, Bill of Materials, and schematic diagrams	3, 4, 6–15
8	4/21	Updated <i>Boot Loader GPIO Select (MAX32651 Only)</i> section, Table 1, and <i>MAX32650 EV Kit Schematics</i>	3, 4, 8–15

For pricing, delivery, and ordering information, please contact Maxim Direct at 1-888-629-4642, or visit Maxim Integrated's website at www.maximintegrated.com.

Maxim Integrated cannot assume responsibility for use of any circuitry other than circuitry entirely embodied in a Maxim Integrated product. No circuit patent licenses are implied. Maxim Integrated reserves the right to change the circuitry and specifications without notice at any time.

X-ON Electronics

Largest Supplier of Electrical and Electronic Components

Click to view similar products for [Development Boards & Kits - ARM category](#):

Click to view products by [Maxim manufacturer](#):

Other Similar products are found below :

[SAFETI-HSK-RM48](#) [PICOHOBBITFL](#) [CC-ACC-MMK-2443](#) [EVALSPEAR320CPU](#) [TMDX570LS04HDK](#) [TXSD-SV70](#) [TXSD-SV71](#)
[YGRPEACHNORMAL](#) [PICODWARFFL](#) [YR8A77450HA02BG](#) [3580](#) [32F3348DISCOVERY](#) [ATTINY1607](#) [CURIOSITY NANO](#)
[PIC16F15376](#) [CURIOSITY NANO BOARD](#) [PIC18F47Q10](#) [CURIOSITY NANO](#) [VISIONSTK-6ULL V.2.0](#) [80-001428](#) [DEV-17717](#)
[EAK00360](#) [YR0K77210B000BE](#) [RTK7EKA2L1S00001BE](#) [SLN-VIZN-IOT](#) [LV18F V6 DEVELOPMENT SYSTEM](#) [READY FOR AVR](#)
[BOARD](#) [READY FOR PIC BOARD](#) [READY FOR PIC \(DIP28\)](#) [AVRPLC16 V6 PLC SYSTEM](#) [MIKROLAB FOR AVR XL](#) [MIKROLAB](#)
[FOR PIC L](#) [MINI-AT BOARD - 5V](#) [MINI-M4 FOR STELLARIS](#) [MOD-09.Z](#) [BUGGY + CLICKER 2 FOR PIC32MX + BLUETOOT](#) [1410](#)
[LETS MAKE PROJECT PROGRAM. RELAY PIC](#) [LETS MAKE - VOICE CONTROLLED LIGHTS](#) [LPC-H2294](#) [DSPIC-READY2 BOARD](#)
[DSPIC-READY3 BOARD](#) [MIKROBOARD FOR ARM 64-PIN](#) [MIKROLAB FOR AVR](#) [MIKROLAB FOR AVR L](#) [MIKROLAB FOR](#)
[DSPIC](#) [MIKROLAB FOR DSPIC XL](#) [MIKROLAB FOR PIC32](#) [MIKROLAB FOR TIVA](#) [EASYAVR V7](#) [EASYMX PRO FOR TIVA C](#)
[SERIES](#) [EASYMX PRO V7 FOR STM32](#) [EASYPIC FUSION V7](#)