



3V to 5.5V, up to 250kbps True RS-232 Transceiver with 4 μ A AutoShutdown Plus and Power-On Reset

MAX3320A/B/L/T

General Description

The MAX3320 combines a microprocessor (μ P) supervisory circuit with an RS-232 transceiver. The power-on reset performs a single function: it asserts a reset signal whenever the V_{CC} supply voltage declines below a pre-set threshold, staying asserted for at least 100ms after V_{CC} rises above the reset threshold. The MAX3320 has an active-low $\overline{\text{RESET}}$ output, which is guaranteed to be in the correct state for V_{CC} down to 1V. The reset comparator is designed to ignore fast transients on V_{CC} . Reset thresholds suitable for operation with a variety of supply voltages are available.

The MAX3320 transceivers have a proprietary low-dropout transmitter output stage, enabling true RS-232 performance with a dual charge pump powered from a +3V to +5.5V supply. The device requires only four small 0.1 μ F external charge-pump capacitors, and is guaranteed to run at data rates of up to 250kbps. It comes in the space-saving 20-pin SSOP package.

Applications

Palmtop Computers
 Portable/Battery-Powered Equipment
 Hand-Held Equipment
 Peripherals
 Printers

Pin Configuration

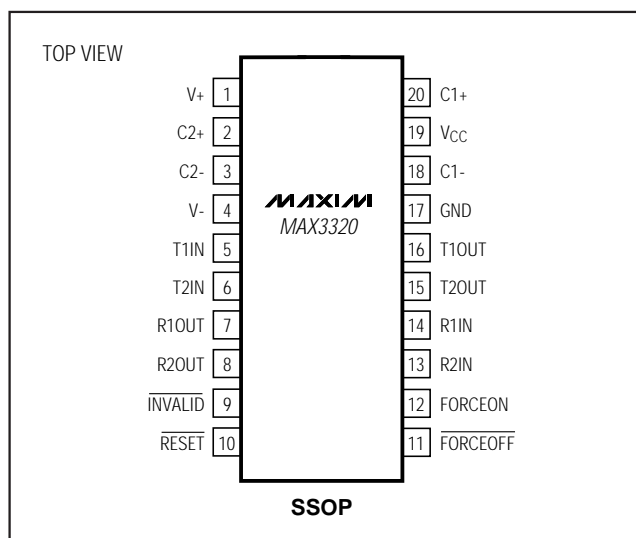

Features

- ◆ **Precise Monitoring of 5V and 3.3V Power-Supply Voltages:**
 - 100ms (min) Power-On $\overline{\text{RESET}}$ Pulse Width
 - Power-Supply Transient Immunity
 - Guaranteed $\overline{\text{RESET}}$ Valid to $V_{CC} = 1V$
- ◆ **4 μ A Supply Current Achieved with AutoShutdown Plus**
- ◆ **Receivers Always Active**
- ◆ **Power-On Reset Always Active**
- ◆ **4 μ A Low-Power Shutdown**
- ◆ **250kbps Guaranteed Data Rate**

Ordering Information

PART*	TEMP. RANGE	PIN-PACKAGE
MAX3320_CAP	0°C to +70°C	20 SSOP
MAX3320_EAP	-40°C to +85°C	20 SSOP

* This part offers a choice of reset threshold voltage. From the table below, select the suffix corresponding to the desired threshold and insert it into the blank to complete the part number.

SUFFIX	RESET THRESHOLD (V)
A	4.25
B	2.85
L	4.63
T	3.08

Typical Operating Circuit appears at end of data sheet.

AutoShutdown Plus is a trademark of Maxim Integrated Products.



Maxim Integrated Products 1

For free samples & the latest literature: <http://www.maxim-ic.com>, or phone 1-800-998-8800.
 For small orders, phone 408-737-7600 ext. 3468.

3V to 5.5V, up to 250kbps True RS-232 Transceiver with 4 μ A AutoShutdown Plus and Power-On Reset

ABSOLUTE MAXIMUM RATINGS

V _{CC}	-0.3V to 6V	Short-Circuit Duration	
V+ (Note 1)	-0.3V to 7V	T _{OUT}	Continuous
V- (Note 1)	0.3V to -7V	Continuous Power Dissipation (T _A = +70°C)	
V+ + V- (Note 1)	13V	SSOP (derate 8.00mW/°C above +70°C)640mW
Input Voltages		Operating Temperature Ranges	
T _{IN} , FORCEOFF, FORCEON	-0.3V to 6V	MAX3320_CAP	0°C to +70°C
R _{IN}	±25V	MAX3320_EAP	-40°C to +85°C
Output Voltages		Storage Temperature Range	-65°C to +160°C
T _{OUT}	±13.2V	Lead Temperature (soldering, 10sec)	+300°C
R _{OUT} , INVALID, RESET	-0.3V to (V _{CC} + 0.3V)		

Note 1: V+ and V- can have a magnitude of +7V (max), but their absolute difference cannot exceed +13V.

Stresses beyond those listed under "Absolute Maximum Ratings" may cause permanent damage to the device. These are stress ratings only, and functional operation of the device at these or any other conditions beyond those indicated in the operational sections of the specifications is not implied. Exposure to absolute maximum rating conditions for extended periods may affect device reliability.

ELECTRICAL CHARACTERISTICS

(V_{CC} = 3V to 5.5V, C1–C4 = 0.1 μ F (tested at 3.3V \pm 10%), C1 = 0.047 μ F, C2–C4 = 0.33 μ F (tested at 5V \pm 10%), T_A = T_{MIN} to T_{MAX}, unless otherwise noted. Typical values are at T_A = +25°C.)

PARAMETER	CONDITIONS	MIN	TYP	MAX	UNITS
DC CHARACTERISTICS					
Power-Supply Current	No load, V _{CC} = 3.3V or 5V, T _A = +25°C		0.45	1.0	mA
Shutdown Supply Current	FORCEOFF = GND, T _A = +25°C		4.0	10	μ A
AutoShutdown Plus Supply Current	All R _{IN} unconnected, FORCEON = GND, FORCEOFF = V _{CC} , all T _{IN} = V _{CC} or GND, T _A = +25°C		4.0	10	μ A
LOGIC INPUTS AND RECEIVER OUTPUTS					
Input Logic Threshold Low	T _{IN} , FORCEON, FORCEOFF			0.8	V
Input Logic Threshold High	T _{IN} , FORCEON, FORCEOFF	V _{CC} = 3.3V	2.0		V
		V _{CC} = 5V	2.4		
Input Leakage Current	T _{IN} , FORCEON, FORCEOFF		±0.01	±1.0	μ A
Input Hysteresis	T _{IN} , FORCEON, FORCEOFF		250		mV
Output Voltage Low	I _{OUT} = 1.6mA			0.4	V
Output Voltage High	I _{OUT} = -1mA	V _{CC} - 0.6	V _{CC} - 0.1		V
RECEIVER INPUTS					
Input Voltage Range		-25		25	V
Input Threshold Low	V _{CC} = 3.3V	0.6	1.2		V
	V _{CC} = 5V	0.8	1.5		
Input Threshold High	V _{CC} = 3.3V		1.5	2.4	V
	V _{CC} = 5V		1.8	2.4	
Input Hysteresis			0.3		V
Input Resistance	T _A = +25°C	3	5	7	k Ω
INVALID OUTPUT					
Receiver Input Threshold to INVALID Output High	Figure 3, positive threshold			2.7	V
	Figure 3, negative threshold	-2.7			
Receiver Input Threshold to INVALID Output Low	Figure 3	-0.3		0.3	V
INVALID Output Voltage Low	I _{OUT} = 1.6mA			0.4	V

3V to 5.5V, up to 250kbps True RS-232 Transceiver with 4μA AutoShutdown Plus and Power-On Reset

MAX3320A/B/L/T

ELECTRICAL CHARACTERISTICS (continued)

(V_{CC} = 3V to 5.5V, C1–C4 = 0.1μF (tested at 3.3V ±10%), C1 = 0.047μF, C2–C4 = 0.33μF (tested at 5V ±10%), T_A = T_{MIN} to T_{MAX}, unless otherwise noted. Typical values are at T_A = +25°C.)

PARAMETER	CONDITIONS	MIN	TYP	MAX	UNITS
$\overline{\text{INVALID}}$ Output Voltage High	I _{OUT} = -1mA	V _{CC} - 0.6			V
Receiver Positive or Negative Threshold to $\overline{\text{INVALID}}$ High	Figure 3	0.1			μs
Receiver Positive or Negative Threshold to $\overline{\text{INVALID}}$ Low	Figure 3	90			μs
AUTOSHUTDOWN PLUS (FORCEON = GND, FORCEOFF = V_{CC})					
Receiver or Transmitter Edge to Transmitters Enabled	Figure 5	25			μs
Receiver or Transmitter Edge to Shutdown	Figure 3	15	30	60	sec
TRANSMITTER OUTPUTS					
Output Voltage Swing	All transmitter outputs loaded with 3kΩ to ground	±5.0	±5.4		V
Output Resistance	V _{CC} = V ₊ = V ₋ = GND, V _{T_OUT} = ±2V	300	10M		Ω
Output Short-Circuit Current	T _{OUT} = GND, T _{IN} = V _{CC} or GND		±35	±60	mA
Output Leakage Current	V _{T_OUT} = ±12V, V _{CC} = 0 to 5.5V, transmitters disabled			±25	μA
RESET OUTPUT					
$\overline{\text{RESET}}$ Operating Voltage Range	MAX3320_C	1.0		5.5	V
	MAX3320_E	1.2		5.5	
$\overline{\text{RESET}}$ Threshold	MAX3320A	4.00	4.25	4.50	V
	MAX3320B	2.70	2.85	3.00	
	MAX3320L	4.50	4.63	4.75	
	MAX3320T	3.00	3.08	3.15	
$\overline{\text{RESET}}$ Output Voltage	I _{SINK} = 1.2mA, V _{CC} = reset threshold, MAX3320B/T			0.3	V
	I _{SINK} = 3.2mA, V _{CC} = reset threshold, MAX3320A/L			0.4	
	I _{SINK} = 50μA, V _{CC} > 1V, MAX3320_C			0.3	
	I _{SINK} = 100μA, V _{CC} > 1.2V, MAX3320_E			0.4	

3V to 5.5V, up to 250kbps True RS-232 Transceiver with 4μA AutoShutdown Plus and Power-On Reset

TIMING CHARACTERISTICS

(V_{CC} = 3V to 5.5V, C₁-C₄ = 0.1μF, C₁-C₄ = 0.1μF (for 3.3V ±10%), C₁ = 0.047μF, C₂-C₄ = 0.33μF (tested at 5V ±10%), T_A = T_{MIN} to T_{MAX}, unless otherwise noted. Typical values are at T_A = +25°C.)

PARAMETER	CONDITIONS	MIN	TYP	MAX	UNITS
Maximum Data Rate	R _L = 3kΩ, C _L = 1000pF, one transmitter switching	250			kbps
Receiver Propagation Delay	R _{IN} to R _{OUT} , C _L = 150pF	t _{PHL}	0.3		μs
		t _{PLH}	0.3		
Transmitter Skew	t _{PHL} - t _{PLH}		100		ns
Receiver Skew	t _{PHL} - t _{PLH}		200		ns
Transition-Region Slew Rate	V _{CC} = 3.3V, R _L = 3kΩ to 7kΩ, measured from +3V to -3V or -3V to +3V, T _A = +25°C	C _L = 150pF to 1000pf	6	30	V/μs
		C _L = 150pF to 2500pf	4	30	
V _{CC} to $\overline{\text{RESET}}$ Delay	100mV overdrive from reset threshold		40		μs
$\overline{\text{RESET}}$ Active Timeout Period	V _{CC} = reset threshold	100		280	ms

Typical Operating Characteristics

(V_{CC} = 3.3V, 250kbps data rate, C₁-C₄ = 0.1μF, all transmitters loaded with 3kΩ. Typical values are at T_A = +25°C, unless otherwise noted.)

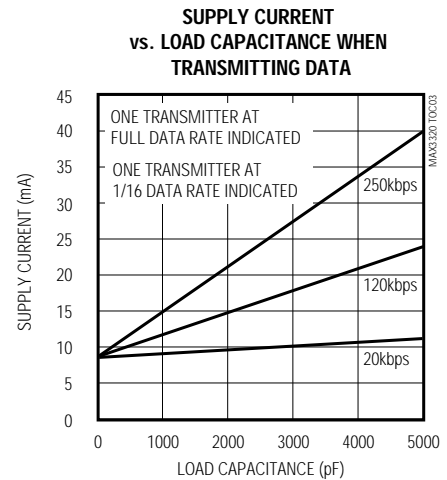
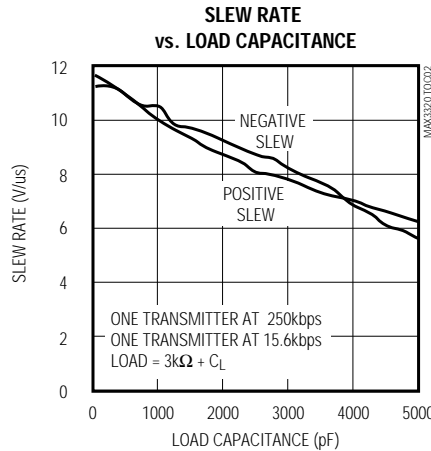
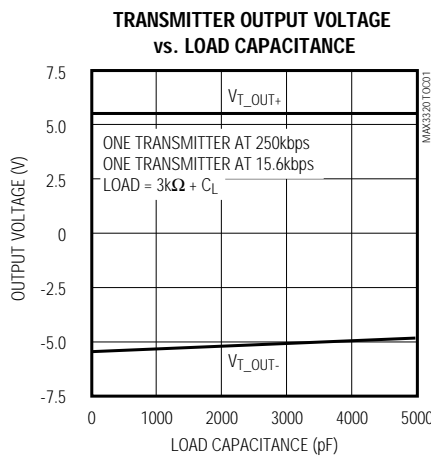

3V to 5.5V, up to 250kbps True RS-232 Transceiver with 4 μ A AutoShutdown Plus and Power-On Reset

MAX3320A/B/L/T

Typical Operating Characteristics (continued)

(V_{CC} = 3.3V, 250kbps data rate, C1–C4 = 0.1 μ F, all transmitters loaded with 3k Ω . Typical values are at T_A = +25°C, unless otherwise noted.)

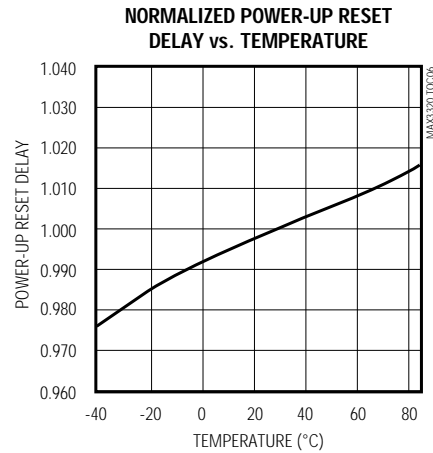
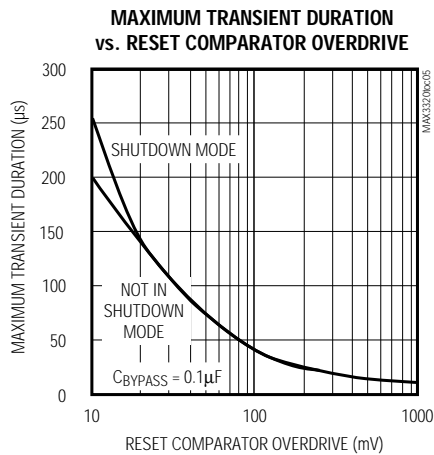

Pin Description

PIN	NAME	FUNCTION
1	V+	5.5V generated by the charge pump
2	C2+	Positive terminal of inverting charge-pump capacitor
3	C2-	Negative terminal of inverting charge-pump capacitor
4	V-	-5.5V generated by the charge pump
5, 6	T_IN	TTL/CMOS Transmitter Inputs (T1IN and T2IN)
7, 8	R_OUT	TTL/CMOS Receiver Outputs (R1OUT and R2OUT)
9	$\overline{\text{INVALID}}$	Output of the Valid Signal Detector. Asserts when no valid RS-232 levels are present on any of the receiver inputs for 90 μ s.
10	$\overline{\text{RESET}}$	$\overline{\text{RESET}}$ Output. $\overline{\text{RESET}}$ remains low while V _{CC} is below the reset threshold, and for 280ms (max) after V _{CC} rises above the reset threshold.
11	$\overline{\text{FORCEOFF}}$	Force-Off Input. Drive $\overline{\text{FORCEOFF}}$ low to shut down transmitters and on-board power supply. This overrides AutoShutdown Plus and FORCEON (Table 1).
12	FORCEON	Force-On Input. Drive FORCEON high to override AutoShutdown Plus, keeping transmitters on ($\overline{\text{FORCEOFF}}$ must be high) (Table 1).
13, 14	R_IN	RS-232 Receiver Inputs (R2IN and R1IN)
15, 16	T_OUT	RS-232 Transmitter Outputs (T2OUT and T1OUT)
17	GND	Ground
18	C1-	Negative terminal of voltage-doubler charge-pump capacitor
19	V _{CC}	+3V to +5.5V Supply Voltage
20	C1+	Positive terminal of voltage-doubler charge-pump capacitor

3V to 5.5V, up to 250kbps True RS-232 Transceiver with 4 μ A AutoShutdown Plus and Power-On Reset

Table 1. MAX3320 Output Control Truth Table

FORCEON	$\overline{\text{FORCEOFF}}$	AUTOSHUTDOWN PLUS*	OPERATION STATUS	T_OUT	R_OUT
X	0	X	Shutdown (forced off)	High-Z	Active
1	1	X	Normal operation (forced on)	Active	Active
0	1	<30sec*	Normal operation (AutoShutdown Plus)	Active	Active
0	1	>30sec*	Shutdown (AutoShutdown Plus)	High-Z	Active

X = Don't Care

*Time since last receiver or transmitter input activity

Detailed Description

Dual Charge-Pump Voltage Converter

The MAX3320's internal power supply consists of a regulated dual charge pump that provides output voltages of +5.5V (doubling charge pump) and -5.5V (inverting charge pump) while V_{CC} remains in the 3V to 5.5V range. The charge pumps operate in discontinuous mode; they are enabled if the output voltages are less than 5.5V, and disabled if output voltages exceed 5.5V. Each charge pump requires a flying capacitor (C1, C2) and a reservoir capacitor (C3, C4) to generate the V+ and V- supplies.

RS-232 Transmitters

The transmitters are inverting level translators that convert CMOS-logic levels to 5V EIA/TIA-232 levels. The MAX3320 transmitters guarantee a 250kbps data rate with worst-case loads of 3k Ω in parallel with 1000pF, providing compatibility with PC-to-PC communication software (such as LapLink™). Transmitters can be paralleled to drive multiple receivers. Figure 1 shows a complete system connection.

When $\overline{\text{FORCEOFF}}$ is driven to ground, the transmitter's outputs become high impedance. When the AutoShutdown Plus circuitry senses that all receiver and transmitter inputs are inactive for more than 30sec, the transmitters turn off and the outputs go into a high-impedance state, but the receivers remain active. When the power is off or the MAX3320 is shut down, outputs may be driven up to $\pm 12V$.

The transmitter inputs do not have pull-up resistors. Connect unused inputs to GND or V_{CC}.

Laplink is a trademark of Traveling Software.

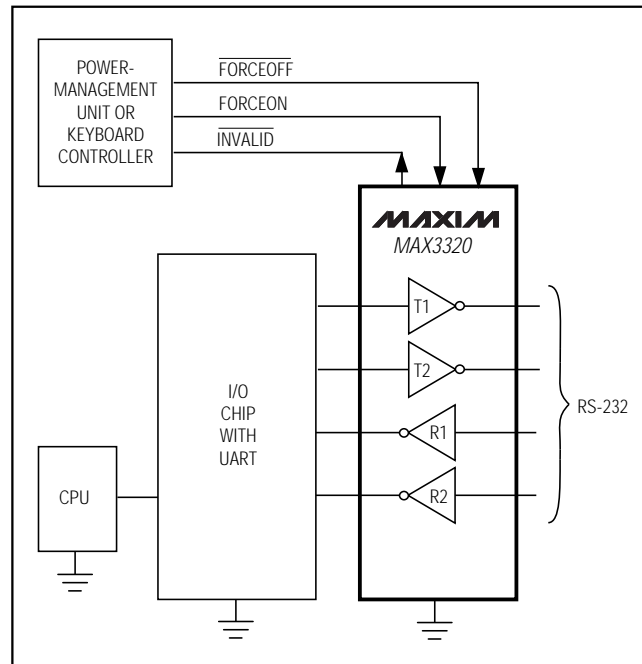

Figure 1. Interface Under Control of PMU

RS-232 Receivers

The receivers convert RS-232 signals to CMOS-logic output levels. All receivers have inverting outputs and are active in shutdown $\overline{\text{FORCEOFF}}$ (Table 1).

AutoShutdown Plus Mode

Maxim's AutoShutdown Plus feature, which operates when $\overline{\text{FORCEOFF}}$ is high and FORCEON is low, achieves a 4 μ A supply current. When the MAX3320 senses no valid signal levels on all receiver and transmitter inputs for 30sec, the on-board power supply and drivers shut off,

3V to 5.5V, up to 250kbps True RS-232 Transceiver with 4μA AutoShutdown Plus and Power-On Reset

MAX3320A/B/L/T

reducing supply current to 4μA. This occurs if the RS-232 cable is disconnected or the connected peripheral transmitters turn off. The system turns on again when a valid transition occurs at any RS-232 receiver or transmitter input. As a result, the system saves power without changes to the existing BIOS or operating system. The $\overline{\text{INVALID}}$ output is high when the receivers are active. Since $\overline{\text{INVALID}}$ indicates the receiver inputs' condition, it can be used in any mode (Figure 2).

Tables 1 and 2 and Figure 2 summarize the MAX3320's operating modes. FORCEON and FORCEOFF override the automatic circuitry and force the transceiver into its normal operating state or into its low-power standby state. When neither control is asserted, the IC enters AutoShutdown Plus mode and selects between these states automatically, based on the last receiver or transmitter input edge received.

When shut down, the device's charge pumps turn off, V+ decays to VCC, V- decays to ground, and the transmitter outputs turn off (high impedance). The time required to exit shutdown is typically 25μs (Figure 3a).

Software-Controlled Shutdown

If direct software control is desired, use $\overline{\text{INVALID}}$ to indicate DTR or Ring Indicator signal. Connect FORCEOFF and FORCEON together to bypass the AutoShutdown Plus feature so the line acts like a SHDN input.

Power-On Reset

In addition to issuing a reset to the microprocessor (μP) during power-up, power-down, and brownout conditions, the MAX3320 is relatively immune to short-duration, negative-going VCC transitions (glitches). Typically, a VCC transient that goes 100mV below the reset threshold and lasts 20μs or less does not cause a reset pulse (see *Typical Operating Characteristics*). Additional bypass capacitance mounted as close as possible to the VCC pin provides additional transient immunity.

Table 2. $\overline{\text{INVALID}}$ Truth Table

RS-232 SIGNAL PRESENT AT RECEIVER INPUT	$\overline{\text{INVALID}}$ OUTPUT
Yes	H
No	L

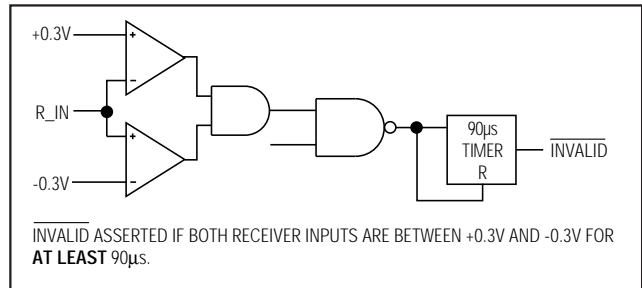

Figure 2a. $\overline{\text{INVALID}}$ Functional Diagram, $\overline{\text{INVALID}}$ Low

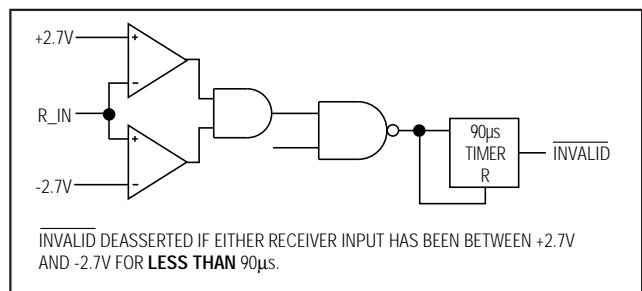

Figure 2b. $\overline{\text{INVALID}}$ Functional Diagram, $\overline{\text{INVALID}}$ High

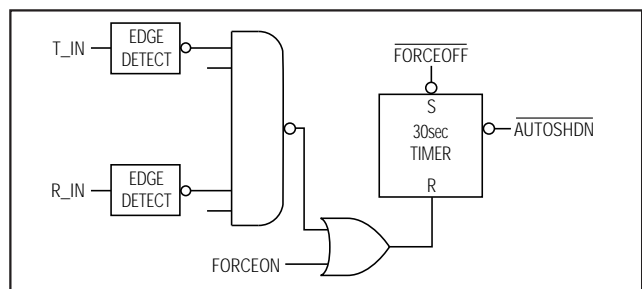

Figure 2c. AutoShutdown Plus Logic

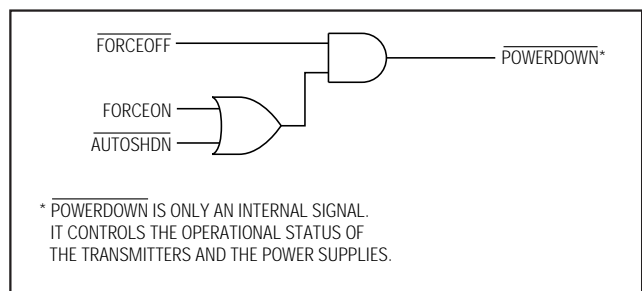

Figure 2d. Power-Down Logic

3V to 5.5V, up to 250kbps True RS-232 Transceiver with 4μA AutoShutdown Plus and Power-On Reset

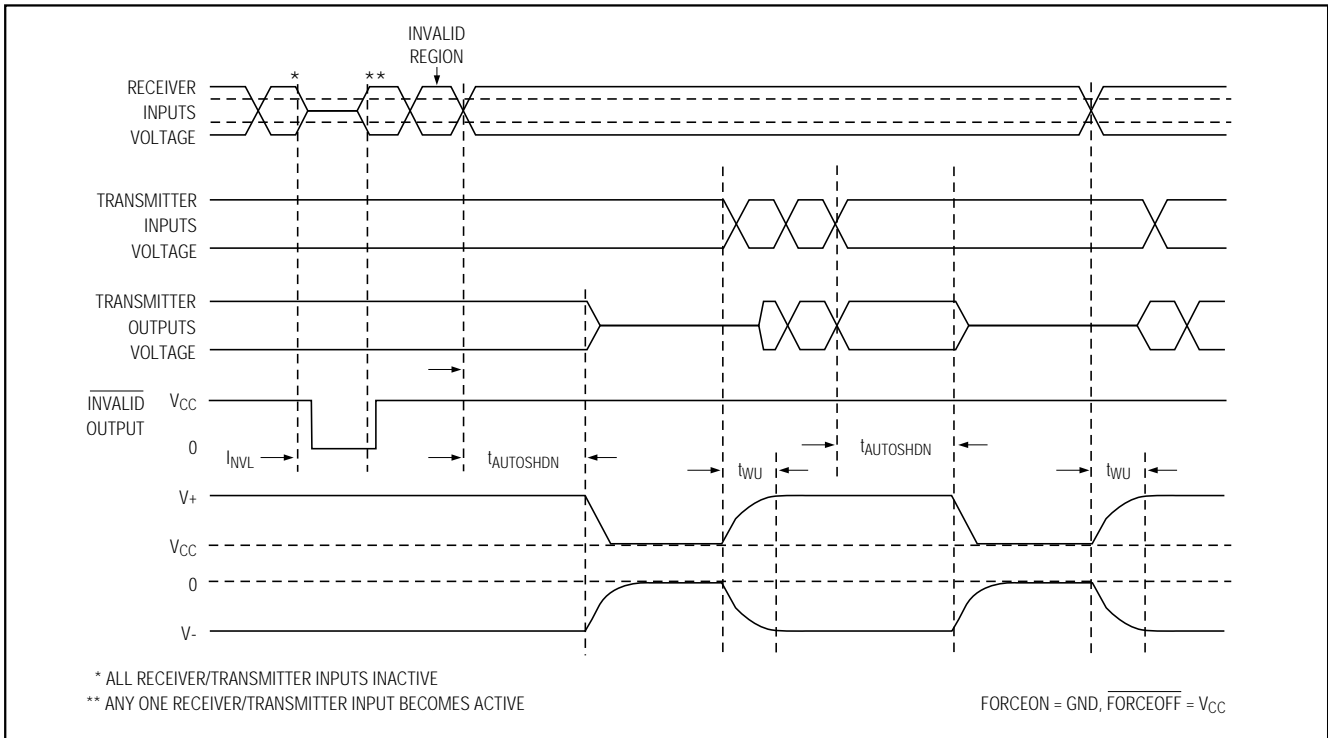

Figure 3a. AutoShutdown Plus and $\overline{\text{INVALID}}$ Timing Diagram

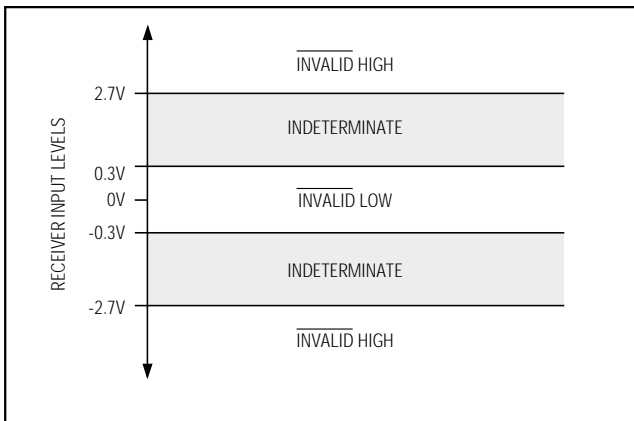

Figure 3b. Receiver Positive/Negative Thresholds for $\overline{\text{INVALID}}$

Applications Information

Ensuring a Valid Reset Output Down to $V_{CC} = 0V$

When V_{CC} falls below 1V, $\overline{\text{RESET}}$ no longer sinks current: it becomes an open circuit. Therefore, high-impedance CMOS logic inputs connected to $\overline{\text{RESET}}$

can drift to undefined voltages. This presents no problem in most applications, since most μPs and other circuitry is inoperative with V_{CC} below 1V. However, in applications where $\overline{\text{RESET}}$ must be valid down to 0V, add a pull-down resistor to ground, holding $\overline{\text{RESET}}$ low (Figure 4). R1's value is not critical; 100k Ω is large enough not to load $\overline{\text{RESET}}$, and small enough to pull it to ground.

Capacitor Selection

The capacitor type used for C1–C4 is not critical for proper operation; use either polarized or nonpolarized capacitors. The charge pump requires 0.1 μF capacitors for 3.3V operation. For other supply voltages, refer to Table 3 for required capacitor values. Do not use values smaller than those listed in Table 3. Increasing the capacitor values (e.g., by a factor of 2) reduces ripple on the transmitter outputs and slightly reduces power consumption. C2, C3, and C4 can be increased without changing C1's value. **However, do not increase C1 without also increasing the values of C2, C3, C4, and CBYPASS, to maintain the proper ratios (C1 to the other capacitors).**

3V to 5.5V, up to 250kbps True RS-232 Transceiver with 4 μ A AutoShutdown Plus and Power-On Reset

MAX3320A/B/L/T

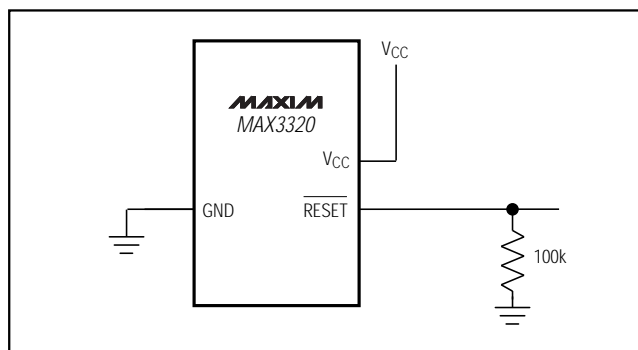

Figure 4. Ensuring $\overline{\text{RESET}}$ Valid to $V_{CC} = 0V$

When using the minimum required capacitor values, make sure the capacitor value does not degrade excessively with temperatures outside the 0°C to +70°C range. If in doubt, use capacitors with a larger nominal value. The capacitor's equivalent series resistance (ESR), which usually rises at low temperatures, influences the amount of ripple on V_+ and V_- .

Transmitter Outputs when Exiting Shutdown

Figure 5 shows two transmitter outputs when exiting shutdown mode. As they become active, the two transmitter outputs go to opposite RS-232 levels (one transmitter input is high; the other is low). Each transmitter is loaded with 3k Ω in parallel with 2500pF. The transmitter outputs display no ringing or undesirable transients as they exit shutdown. Note that the transmitters are enabled only when the magnitude of V_- exceeds approximately 3V.

High Data Rates

The MAX3320 maintains the RS-232 $\pm 5V$ minimum transmitter output voltage even at high data rates. Figure 6 shows a transmitter loop-back test circuit. Figure 7 shows a loop-back test result at 120kbps, and Figure 8 shows the same test at 250kbps. For Figure 7, both transmitters were driven simultaneously at 120kbps into RS-232 loads in parallel with 1000pF. For Figure 8, a single transmitter was driven at 250kbps, and both transmitters were loaded with an RS-232 receiver in parallel with 1000pF.

Interconnection with 3V and 5V Logic

The MAX3320 can directly interface with various 5V logic families, including ACT and HCT CMOS. See Table 4 for more information on possible combinations of interconnections.

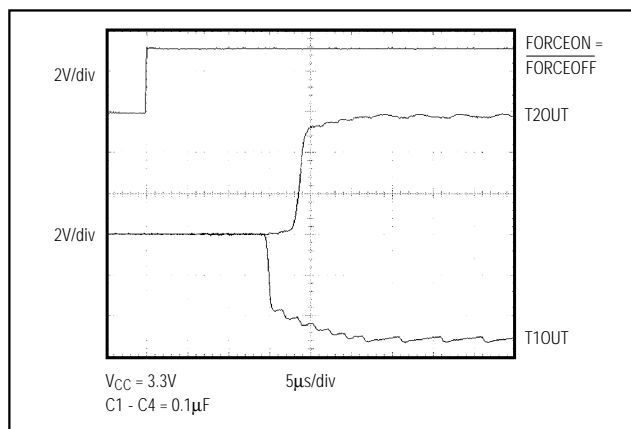

Figure 5. Transmitter Outputs when Exiting Shutdown or Powering Up

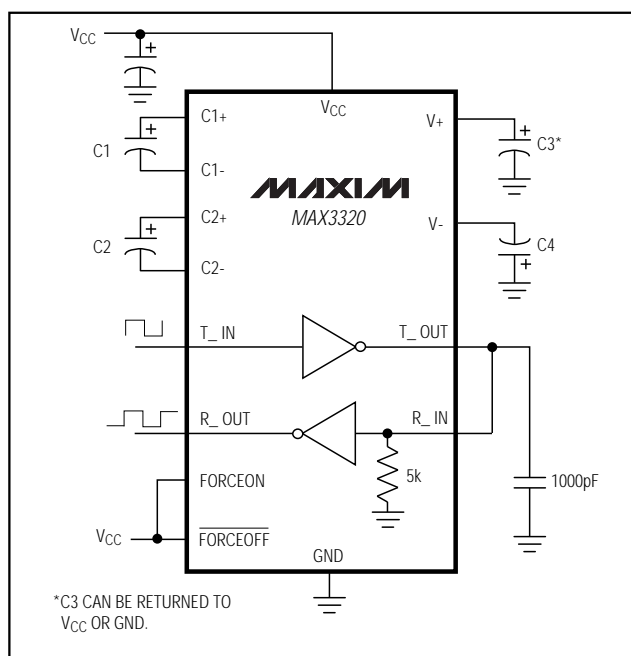

Figure 6. Loop-Back Test Circuit

Table 3. Required Minimum Capacitance Values

V _{CC} (V)	C1 (μF)	C2, C3, C4, C _{BYPASS} (μF)
3 to 3.6	0.1	0.1
4.5 to 5.5	0.047	0.33
3 to 5.5	0.1	0.47

3V to 5.5V, up to 250kbps True RS-232 Transceiver with 4µA AutoShutdown Plus and Power-On Reset

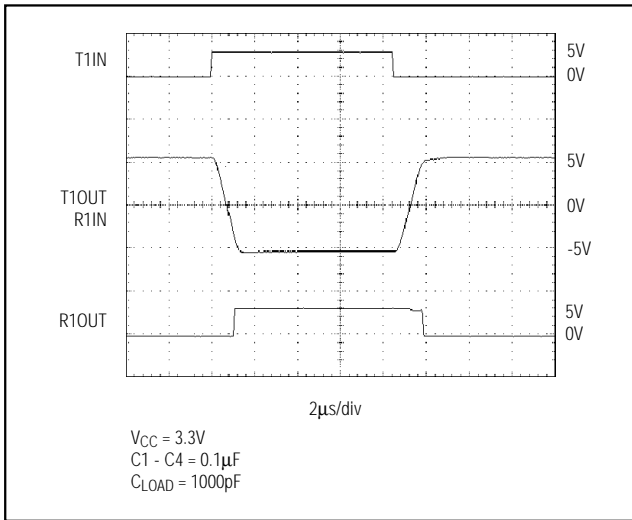

Figure 7. Loop-Back Test Result at 120kbps

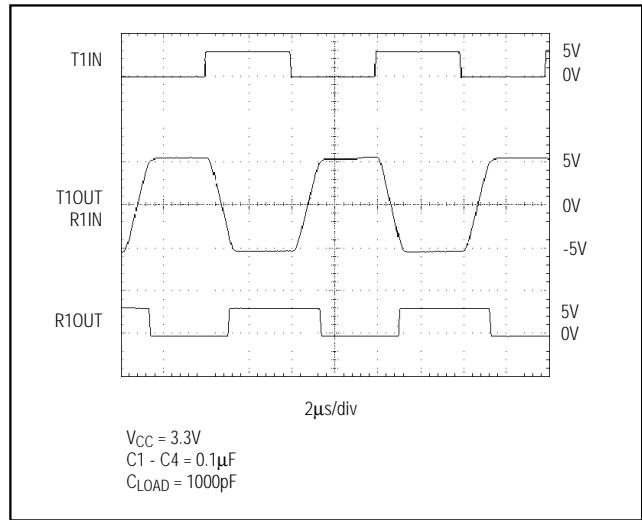

Figure 8. Loop-Back Test Result at 250kbps

Table 4. Logic-Family Compatibility with Various Supply Voltages

SYSTEM POWER-SUPPLY VOLTAGE (V)	V _{CC} SUPPLY VOLTAGE (V)	COMPATIBILITY
3.3	3.3	Compatible with all CMOS families
5	5	Compatible with all TTL and CMOS families
5	3.3	Compatible with ACT and HCT CMOS, and with AC, HC, or CD4000 CMOS

Chip Information

TRANSISTOR COUNT: 1577

3V to 5.5V, up to 250kbps True RS-232 Transceiver with 4 μ A AutoShutdown Plus and Power-On Reset

Typical Operating Circuit

MAX3320A/B/L/T

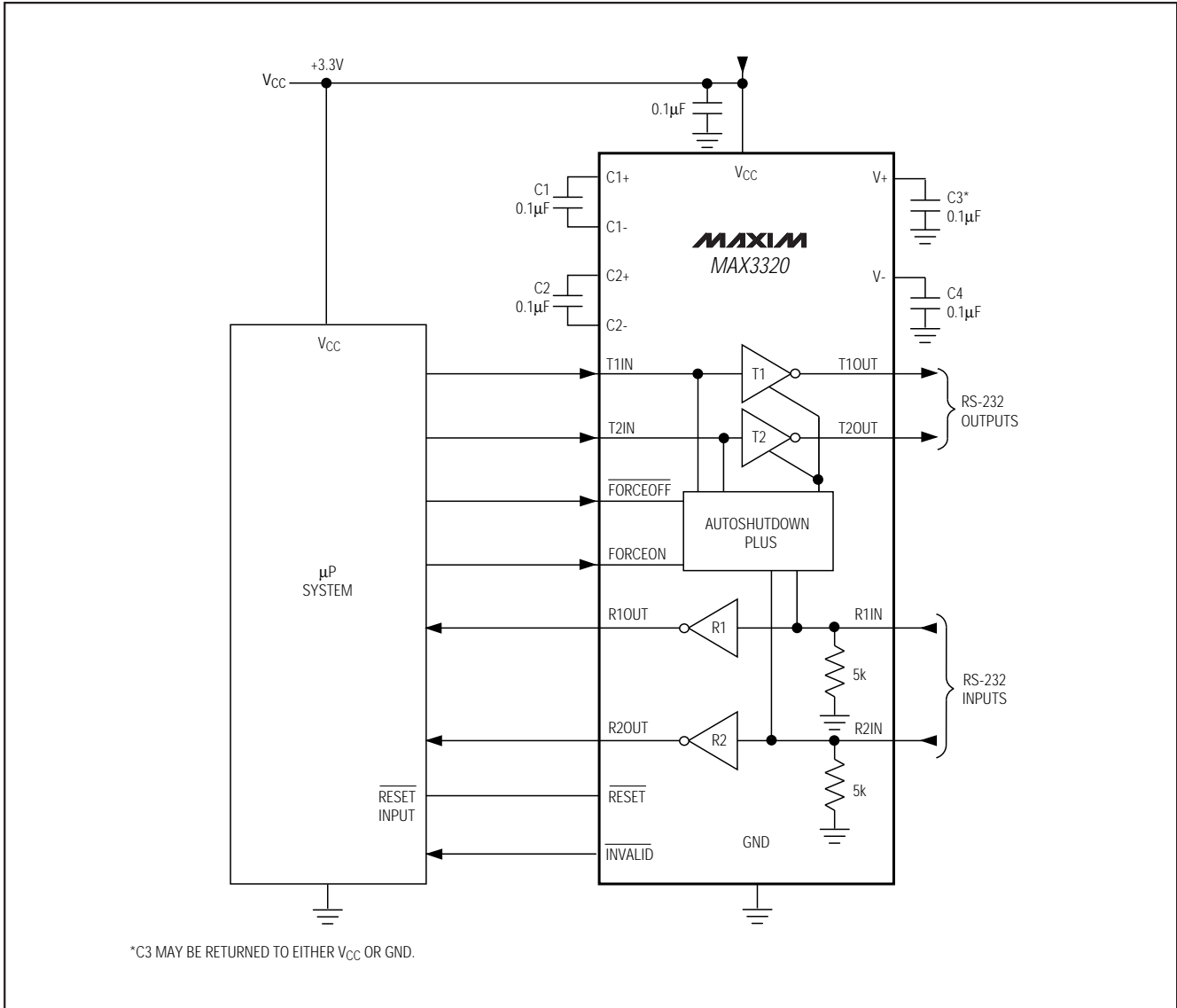

3V to 5.5V, up to 250kbps True RS-232 Transceiver with 4µA AutoShutdown Plus and Power-On Reset

Package Information

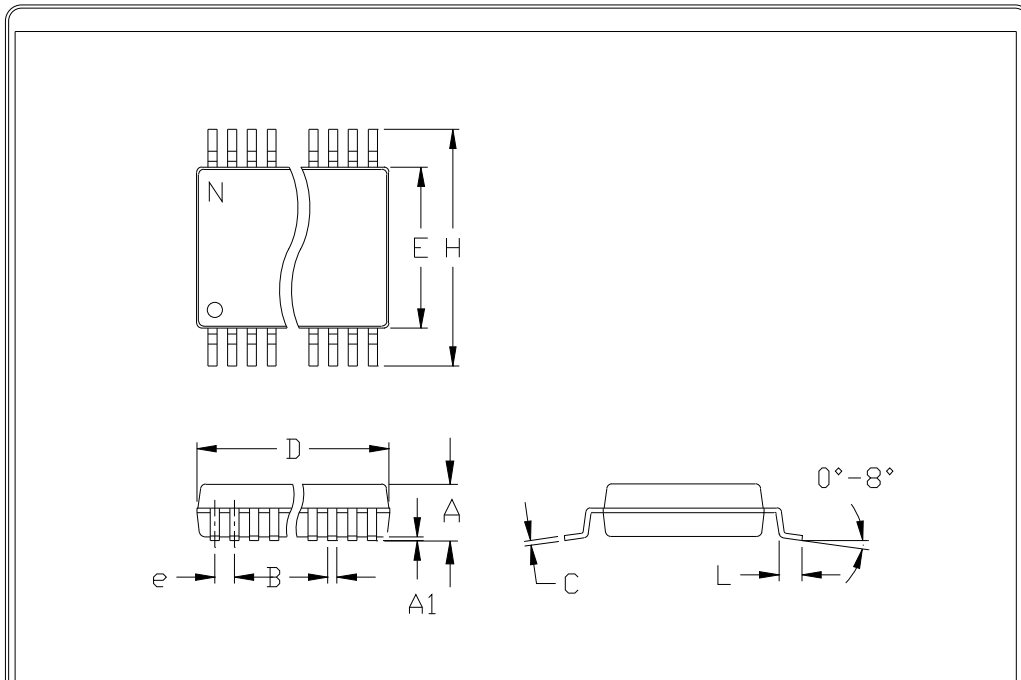

ADDED TO SSOP.DWG FILE

	INCHES		MILLIMETERS	
	MIN	MAX	MIN	MAX
A	0.068	0.078	1.73	1.99
A1	0.002	0.008	0.05	0.21
B	0.010	0.015	0.25	0.38
C	0.005	0.009	0.13	0.22
e	0.0256		0.65	
E	0.205	0.212	5.20	5.38
H	0.301	0.311	7.65	7.90
L	0.022	0.037	0.55	0.95

	INCHES		MILLIMETERS		N
	MIN	MAX	MIN	MAX	
D	0.278	0.289	7.07	7.33	20
D	0.317	0.328	8.07	8.33	24
D	0.397	0.407	10.07	10.33	28

NOTES:

1. D&E DO NOT INCLUDE MOLD FLASH
2. MOLD FLASH OR PROTRUSIONS NOT TO EXCEED .15mm (.006")
3. LEADS TO BE COPLANAR WITHIN .102mm (.004")
4. CONTROLLING DIMENSION: MILLIMETER
5. N = NUMBER OF PINS

 <small>120 SAN GABRIEL DR. SUNNYVALE CA 94086 FAX (408) 737 7754</small> <small>PROPRIETARY INFORMATION</small>	PACKAGE FAMILY OUTLINE: SSOP .200" x .65mm <small>TITLE</small>		21-0039 A <small>DOCUMENT CONTROL NUMBER REV</small>

Maxim cannot assume responsibility for use of any circuitry other than circuitry entirely embodied in a Maxim product. No circuit patent licenses are implied. Maxim reserves the right to change the circuitry and specifications without notice at any time.

12 Maxim Integrated Products, 120 San Gabriel Drive, Sunnyvale, CA 94086 408-737-7600

X-ON Electronics

Largest Supplier of Electrical and Electronic Components

Click to view similar products for [RS-232 Interface IC category](#):

Click to view products by [Maxim manufacturer](#):

Other Similar products are found below :

[062191EB](#) [CH438L](#) [LT1039CN](#) [LTC1327CNW](#) [MAX3386ECPWR](#) [TRS222IDWR](#) [MAX232INE4](#) [MAX3232CPW](#) [MAX204CWE+](#)
[TRS3243EIDWR](#) [TRS3232EIDWR](#) [SN65C3232EDWR](#) [ADM208ARZ-REEL](#) [LT1780CSW#PBF](#) [LT1237CSW#PBF](#) [LT1281AISW#PBF](#)
[LTC1337CSW#PBF](#) [LT1180ACN#PBF](#) [LTC1343CGW#PBF](#) [LT1237CNW#PBF](#) [LT1039CN#PBF](#) [LT1032CSW#PBF](#) [LT1130ACSW#PBF](#)
[LTC1349ISW#PBF](#) [LT1032ISW#PBF](#) [LTM2882IY-3#PBF](#) [LT1140ACN#PBF](#) [LTC1384IG#PBF](#) [LTC1383CS#PBF](#) [LT1280AIN#PBF](#)
[LT1080ISW#PBF](#) [LTC2845IG#PBF](#) [LTC1383CN#PBF](#) [LTC2845CG#PBF](#) [LTC2846CG#PBF](#) [LTC1384CG#PBF](#) [LT1781IS#PBF](#)
[LT1081IN#PBF](#) [LT1131ACNW](#) [LT1131ACSW](#) [SN75188DE4](#) [LTC1350CNW](#) [MAX3209EEUU+T](#) [AD7306AR](#) [AD7306ARZ](#) [AD7306JNZ](#)
[AD7306JRZ](#) [ADM3311EARSZ-REEL](#) [ADM3310EACPZ-REEL7](#) [ADM3202ARUZ-REEL7](#)