

## General Description

The MAX38800 evaluation kit (EV kit) serves as a reference platform for evaluating the MAX38800 voltage regulator IC. This single-chip, integrated switching regulator provides an extremely compact, highly efficient, fast, accurate and reliable power delivery solution for low-output voltage applications. The MAX38800 has different programmability options to enable a wide range of configurations.

The EV kit consists of a fully-assembled and tested Printed Circuit Board (PCB) implementation of the MAX38800. Jumpers, test points, and input/output connectors are included for flexibility and ease-of-use. Refer to the data sheet for ordering information and more details.

## Applications

- Servers/ $\mu$ Servers
- I/O and Chipset Supplies
- GPU Core Supply
- DDR Memory—VDDQ and VTT
- Point-of-Load (PoL) Applications

**Ordering Information** appears at end of data sheet.

## Features

- High-Efficiency Solution
  - Up to 96% Peak
  - Up to 95.5% Full-Load
  - Up to 94% Light-Load Efficiency at 1A with DCM Enabled
- Inductor valley current limit is Configured to 7.5A ( $R\_SEL = R1 = 2.67k\Omega$ )
- Programmable Switching Frequency from 400kHz to 900kHz
- Programmable Positive and Negative OCP Limit
- Programmable Reference Voltage with External Input Option
- Fast Transient Response with Quick PWM™ Architecture
- Differential Remote Sense with Open-Circuit Detection
- Percentage-Based Output Power Good and OVP
- Open-Drain Status Indicator (STAT) Pin
- Input Undervoltage and Overvoltage Lockout
- Adaptive Dead Time Control
- Integrated Boost Switch
- 19-Bump WLCSP (2.2mm x 2.8mm) Footprint
- Operation Using Ceramic Input and Output Capacitors

Quick PWM is a trademark of Maxim Integrated Products, Inc.

## Quick Start

### Required Equipment

- MAX38800 EV kit
- 12V, 10A DC power supply
- Load capable of sinking 7.5A
- Digital voltmeter
- Oscilloscope

### Procedure

The EV kit is fully assembled and tested. Follow the steps below to verify the board operation. **Caution: Do not turn on power supply until all connections are completed.**

- 1) Connect a 12V power supply to the VDD1 and GND1 banana jacks.
- 2) Make sure the shunt is installed on:
  - a) J16 (1-2) to close the sense line.
  - b) J4 (1-2) to power up the on-board LDO which regulates 1.8V.
  - c) J12 (1-2) to provide the 1.8V bias supply to the regulator from the on-board LDO.
  - d) J15 (3-5) to pull up the STAT pin.
  - e) J15 (4-6) to pull up the OE pin.
- 3) Connect a voltmeter to the VOUT and GND banana jacks (J8, J11, J13, and J14 can be used as well).
- 4) Turn on the power supply.
- 5) Verify that the voltmeter reads 3.3V.

## Detailed Description of Hardware

The MAX38800 provides compact, high-efficiency power delivery for precision outputs that demand fast transient response. The 19-ball (2.2mm x 2.8mm) CSP package minimizes the PCB area. The EV kit is preset for 3.3V output and can provide up to 7.5A from a 6.5V to 14V input supply.

### Bias Supply

The MAX38800 EV kit has an on-board LDO (U2) that can provide the required 1.8V VCC bias voltage to both the regulator and pullup voltage for the Output Enable (OE) input. This allows testing the part using a single external power supply.

To enable the on-board LDO install the shunt on jumper J4. To effectively use the LDO to supply the VCC bias voltage to the regulator also install the shunt on jumper J12.

In order to properly measure the efficiency of the regulator, the LDO should not be active. The shunts on J4 and J12 need to be removed to disable the LDO. An external 1.8V, 0.1A current-limited power supply needs to be connected between J12-2 and ground. The same signal should be connected to J10 (1-2) to pull up the OE pin.

### Regulator enable

To enable the regulator, OE pin needs to be pulled high. If the on-board 1.8V LDO is active (the shunt on jumper J4 is in place), the output voltage can be used for the purpose. Installing a shunt on J15 (4-6) pulls the OE signal high to 1.8V through a 20k $\Omega$  resistor. To shut down the regulator a shunt needs to be installed on J10. This forces the OE pin low.

### Status Pin

The MAX38800 has an open collector status (STAT) output to report fault or output undervoltage event. Install a shunt on J15 (3-5) to pull up this pin to V<sub>CC</sub> through a 20k $\Omega$  resistor. Since STAT pin is 3.3V tolerant, a shunt on J15 (1-3) can be installed to pull up this pin through a 20k $\Omega$  resistor to the 3.3V provided by the on board regulator U3 (install a shunt on J5 (3-4) to enable the LDO).

### Scenario Selection

Several parameters of the MAX38800 can be programmed to allow optimization for specific applications. By selecting the appropriate value of resistor R\_SEL (R1) and capacitor C\_SEL (C4), the optimum set of parameters (scenario) can be programmed.

While R\_SEL selects the proper scenario, C\_SEL determines the nominal F<sub>SW</sub>. The MAX38800 features a configuration table to provide a wide range of options. [Table 1](#) shows the scenario table for MAX38800.

### Setting the Output Voltage

The output voltage of MAX38800 depends both on the reference voltage ( $V_{REF}$ ) and the resistor divider ratio.

#### Equation 1

$$V_{OUT} = V_{REF} \times \left( 1 + \frac{R_6}{R_9} \right)$$

The reference voltage is selected through  $R_{SEL}$  (see [Table 1](#)) and can be either internal or external (refer to the data sheet for more details). In order to optimize the common mode rejection of the error amplifier, choose the voltage divider resistors so that their parallel resistance  $R_{PAR}$  is as close as possible to  $2k\Omega$ .

#### Equation 2

$$R_6 = V_{OUT} \times \left( \frac{R_{PAR}}{V_{REF}} \right)$$

$$R_9 = R_6 \times \left( \frac{R_{PAR}}{R_6 - R_{PAR}} \right)$$

where,

$R_6$  = Top divider resistor

$R_9$  = Bottom divider resistor

$R_{PAR}$  = Desired parallel resistance of  $R_6$  and  $R_9$

$V_{OUT}$  = Output voltage

$V_{REF}$  = Reference voltage

### Operation with External $V_{REF}$

When using an external reference adopt the configuration shown in [Figure 1](#). Once OE is asserted, the regulator briefly discharges the SENSE- node and releases it as regulation begins. In this case, the soft-start ramp is determined by the external low-pass filter time constant. The external filter time constant needs to be lower than  $T_{SS}/3$  in order to avoid premature assertion of STAT pin while the output voltage is still ramping.

The external reference voltage can be applied prior to enabling the regulator, or ramped up right after enable is asserted. In both cases, the low-pass filtered reference voltage at SENSE- pin must reach its final value within  $T_{SS}$ .

Typical values for the filter components are:

- $R_F = 2.2k\Omega$
- $C_F = 0.22\mu F$

**Table 1. MAX38800 Configuration Table**

R_SEL (kΩ)	V_REF (V)	SOFT-START TIME (T <sub>SS</sub> ) (ms)	VALLEY OCP INCEPTION (A)	OPERATION MODES	REPORTING (CURRENT/TEMP)	RSENSE (GAIN) (MΩ)	F <sub>SW</sub> (kHz)			T <sub>STAT</sub> (μs)	
							C_SEL				
							0pF	200 pF	820 pF		
1.78	0.95	6	6	CCM	Current	2.1	700	800	900	2000	
2.67			7.5	CCM/DCM							
4.02		3	6	CCM							
6.04			7.5	CCM/DCM							
9.09	Ext.	1.5	6	CCM							
13.3			6	CCM							
20.0	0.6	6	9	CCM/DCM							
30.9				CCM							
46.4			6	6							Temp
71.5											CCM/DCM
107					Current						
162	Ext.	1.5	7.5	CCM	Temp	2.1	400	500	600	128	

**Input Voltage Monitoring**

VDD1 and GND1 sense points as well as J3 can be used to monitor the input supply.

**Output Voltage Monitoring**

J11 and J13 monitor the output voltage. These test points should not be used for loading. Use scopejack J14 to monitor the output voltage ripple on an oscilloscope.

**Efficiency Measurement**

The following steps describe how to measure the regulator efficiency.

- 1) Connect a 12V power supply to the VDD1 and GND1 banana jacks. To avoid the input voltage to drop at high load due to power losses on connection cables connect the sense lines of the power supply to VDD1 and GND1 headers.
- 2) Connect an external 1.8V, 0.1A current limited power supply between J12-2 and ground.
- 3) Connect the same power supply to J10-1 to enable the regulator.

- 4) Connect a load to the VOUT and GND banana jacks for better results. J8 can also be used for low currents.
- 5) Make sure the shunt is installed on J16 (1-2) to close the sense line.
- 6) Remove all the other jumpers.
- 7) Connect a voltmeter to J11 or J13.
- 8) Turn on the power supply.
- 9) Measure  $V_{IN}$ ,  $I_{IN}$ ,  $V_{OUT}$ ,  $I_{OUT}$ ,  $V_{BIAS}$ , and  $I_{BIAS}$ .
- 10) Calculate the efficiency as:

**Equation 3**

$$\eta = \left( \frac{V_{OUT} \times I_{OUT}}{(V_{IN} \times I_{IN}) + (V_{BIAS} \times I_{BIAS})} \right)$$

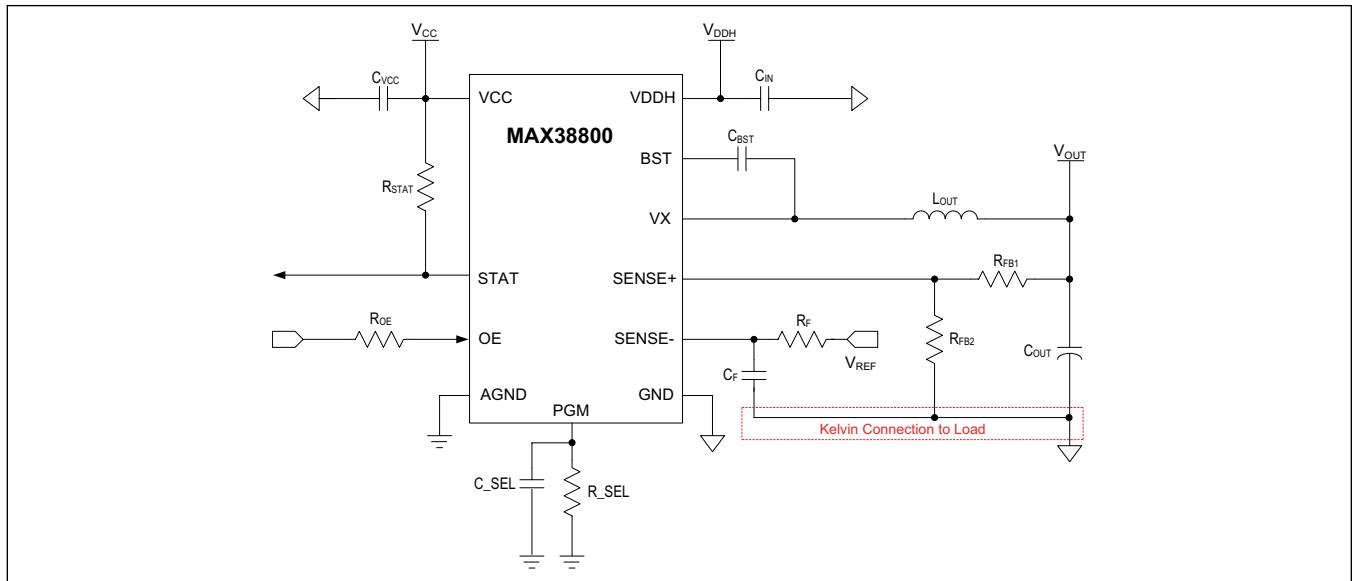

Figure 1. Electrical Connections to Use the External Voltage Reference Feature

MAX3880 EV Kit Bill of Materials

ITEM	REF_DES	QTY	MFG PART #	MFG	VALUE	DESCRIPTION	COMMENTS
1	C1, C2	-	2 TPSE157M016R0100 C0402X7R160104KNE; C105B104K03NNIC; GRM155R71C104K488; C1005X7R1C104K; C0402X7R160104; K17AGEO PHCOMPITAYO YUDEN	AVX	150UF	CAPACITOR, SMT, 7343; TANTALUM, 150UF, 16V, 20%; TFS, 55degC to +125degC	
2	C3	-	1 EMK105B7104KV	VENKEL LTD. (SAMSUNG ELECTRONICS)MURATA/D K17AGEO PHCOMPITAYO YUDEN	0.1UF	CAPACITOR, SMT (0402); CERAMIC CHIP, 0.1UF, 16V, TOL=10%; TG=-55 DEGC TO +125 DEGC; TC=X7R;	
3	C4	-	1 EC140EB1E321K	PANASONIC	820PF	CAPACITOR, SMT (0402); CERAMIC CHIP, 820PF, 25V, TOL=10%; MODEL=ECJ SERIES; TG=-55 DEGC TO +125 DEGC; TC=X7R	
5	C5, C6, C10, C11	-	4 C3216X7R1C106M160AC	TDK	10UF	CAPACITOR, SMT (1206); CERAMIC CHIP, 10UF, 16V, TOL=20%; MODEL=C SERIES; TG=-55 DEGC TO +125 DEGC; TC=X7R	
5	C7, C21, C54	-	3 EMK107B7105MA	TAYO YUDEN	1UF	CAPACITOR, SMT (0603); CERAMIC CHIP, 1UF, 16V, TOL=20%; MODEL=M SERIES; TG=-55 DEGC TO +125 DEGC; TC=X7R	
6	C8	-	1 GRM188R71E474KA12	MURATA	0.47UF	CAPACITOR, SMT (0603); CERAMIC CHIP, 0.47UF, 25V, TOL=10%; MODEL=G RM SERIES; TG=-55 DEGC TO +125 DEGC; TC=X7R	
7	C9, C55	-	1 JMK105BBJ475MV4F; 2 C1005X6R0J475M050BC	TAYO YUDEN; TDK	4.7UF	CAPACITOR, SMT (0402); CERAMIC CHIP, 4.7UF, 6.3V, TOL=20%; TG=-55 DEGC TO +85 DEGC; TC=X7R	
8	C15, C17, C19, C22, C26, C27, C41, C46, C50	-	12 M21BC800	TDK/MURATA	22UF	CAPACITOR, SMT (0805); CERAMIC CHIP, 22UF, 6.3V, TOL=20%; TG=-55 DEGC TO +105 DEGC; TC=X6S	
9	C24	-	1 C0402C103K3RAC; 1 GRM155R71E103KA01D; 1 C1005X7R1E103K	KEMET; MURATA; TDK	0.01UF	CAPACITOR, SMT (0402); CERAMIC CHIP, 0.01UF, 25V, TOL=10%; TG=-55 DEGC TO +125 DEGC; TC=X7R;	
10	C25, C56	-	153KME, GRM155R71E153K 2 A61 C0402X7R250- C0402X6R8K3-105KNP; C1005X6R0J105K; GRM155R60J105KE19;	VENKEL LTD. (MURATA); TDK	0.015UF	CAPACITOR, SMT (0402); CERAMIC CHIP, 0.015UF, 25V, TOL=10%; TG=-55 DEGC TO +125 DEGC; TC=X7R	
11	C36	-	1 JMK105B1105KV	VENKEL LTD. (TDK)MURATA	1UF	CAPACITOR, SMT (0402); CERAMIC CHIP, 1UF, 6.3V, TOL=10%; TG=-55 DEGC TO +85 DEGC; TC=X6R;	
12	C37	-	1 GRM155R71E473K	TDK/MURATA	0.047UF	CAPACITOR, SMT (0402); CERAMIC CHIP, 0.047UF, 25V, TOL=10%; TG=-55 DEGC TO +125 DEGC	
13	C39	-	1 TMK105B1472KV-F	TAYO YUDEN	4700PF	CAPACITOR, SMT (0402); CERAMIC CHIP, 4700PF, 25V, TOL=10%; TG=-55 DEGC TO +85 DEGC; TC=X6R	
14	D1	-	1 2EZ15D5	MICRO COMMERCIAL COMPONENTS	15V	DIODE, ZNR, THROUGH HOLE, AXIAL LEAD (DO-41); VZ=15V, IZ=0.122A	
15	TP3, VDD1, VOUT	-	6 108-0740-001	EMERSON NETWORK POWER	108-0740-001	CONNECTOR, MALE, PANEL MOUNT; BANANA JACK, STRAIGHT; IPIN	
16	R, GND2, J8, VDD1, HEAD, VDD1_MAXIMP AD, VDD1_MAXIMP AD, VOUT_MAXIMP	-	5 PEC01SAAN	SULLINS ELECTRONICS CORP	PEC01SAAN	CONNECTOR, MALE, THROUGH HOLE; BREAKAWAY; STRAIGHT; IPIN	
17	PAD, GND_MAXIMP AD, J2, J6, VDD1_MAXIMP AD, VOUT_MAXIMP	-	6 MAXIMPAD	N/A	MAXIMPAD	EVIK KIT PARTS; MAXIMPAD; NO WIRE TO BE SOLDERED ON THE MAXIMPAD	
18	J1, J4, J10, J13, J16	-	7 PEC02SAAN	SULLINS	PEC02SAAN	CONNECTOR, MALE, THROUGH HOLE; BREAKAWAY; STRAIGHT; 2PINS	

MAX38800 EV Kit Bill of Materials (continued)

ITEM	REF_DES	DNI/ DNP/ QTY	MFG PART #	MFG	VALUE	DESCRIPTION	COMMENTS
19 J3, J14	-	2	SCOPE_PROBE_JACK	MAXIM	SCOPE_PROBE_JACK	EVKIT PART SCOPE_PROBE_JACK	
20 J5, J15	-	2	PEC03DAAN	SULLINS ELECTRONICS CORP.	PEC03DAAN	CONNECTOR; MALE; THROUGH HOLE; BREAKAWAY; STRAIGHT THROUGH; 6PINS; -65 DEGC TO +125 DEGC	
21 J7	-	1	PEC04SAAN	SULLINS ELECTRONICS CORP.	PEC04SAAN	CONNECTOR; MALE; THROUGH HOLE; BREAKAWAY; STRAIGHT; 4PINS	
22 J8	-	1	ED120ZDS	ON-SHORE TECHNOLOGY INC.	ED120ZDS	CONNECTOR; FEMALE; THROUGH HOLE; BLUE TERMINAL BLOCK; STRAIGHT; 2PINS	
23 L1	-	1	GLMCR4703A	ALPS	0.47UH	INDUCTOR; SMT; LIQUALLOY; 0.47UH; TOL=+/-20%; 162A	
24 R1	-	1	ERJ-2RF2671X	PAVASONIC	2.67K	RESISTOR; 0402; 2.67K OHM; 1%; 100PPM; 0.10W; THICK FILM	
25 R2, R3	-	2	CRG0402F10K	TE CONNECTIVITY	10K	RESISTOR; 0402; 10K OHM; 1%; 100PPM; 0.063W; THICK FILM	
R4, R7, R11, R15, R16	-	5	RC0402JR-070RL; CR0402; 5.16W-000RJT	YAGEO PHYCOMP/ENKEL LTD.	0	RESISTOR; 0402; 0 OHM; 5%; JUMPER; 0.063W; THICK FILM	
27 R5, R8	-	2	ERJ-2GEJ233X	PAVASONIC	20K	RESISTOR; 0402; 20K OHM; 5%; 200PPM; 0.10W; THICK FILM	
28 R6	-	1	CR0W0402681FK	WISHAY DALE	6.81K	RESISTOR; 0402; 6.81K OHM; 1%; 100PPM; 0.063W; METAL FILM	
29 R9	-	1	CR0W0402K74FK	WISHAY DALE	2.74K	RESISTOR; 0402; 2.74K; 1%; 100PPM; 0.0625W; THICK FILM	
30 R10	-	1	CR0W04021K00JK	WISHAY DALE	1K	RESISTOR; 0402; 1K OHM; 5%; 100PPM; 0.063W; METAL FILM	
31 R12	-	1	ERA-2AE82801X	PAVASONIC	2.8K	RESISTOR; 0402; 2.8K OHM; 0.1%; 25PPM; 0.063W; METAL FILM	
32 R14	-	1	RCC-0402PW200RF	INTERNATIONAL MANUFACTURING SERVICE	200	RESISTOR; 0402; 200 OHM; 1%; 100PPM; 0.080W; THICK FILM	
33 SUI-SU5	-	5	STC02SYAN	SULLINS ELECTRONICS CORP.	STC02SYAN	TEST POINT; JUMPER; STR; TOTAL LENGTH=0.256IN; BLACK; INSULATION=PBT CONTACT=PHOSPHOR BRONZE; COPPER PLATED TIN OVERALL	
34 U1	-	1	MAX3880DHS+	MAXIM	MAX3880HC S+	EVKIT PART IC; VREG; INTEGRATED; STEP-DOWN SWITCHING REGULATOR; CSP19	
35 U2	-	1	LP2992AIM5-1.8NOPB	TEXAS INSTRUMENTS	LP2992AIM5-1.8NOPB	IC; VREG; MICROPOWER 250-mA LOW-NOISE ULTRALOW-DROPOUT REGULATOR DESIGNED FOR USE WITH VERY LOW-ESR OUTPUT CAPACITOR; SOT23-5	
36 U3	-	1	LP2992AIM5-3.3NOPB	TEXAS INSTRUMENTS	LP2992AIM5-3.3NOPB	IC; VREG; MICROPOWER 250-mA LOW-NOISE ULTRALOW-DROPOUT REGULATOR DESIGNED FOR USE WITH VERY LOW-ESR OUTPUT CAPACITOR; SOT23-5	
37 PCB	-	1	MAX38800	MAXIM	PCB	PCB:MAX38800	
C16, C16, C40, C30, C33, C34, C40, C42-C45, C47-C49, C52, DNP	-	0	N/A	N/A	OPEN	PACKAGE OUTLINE 0805 NON-POLAR CAPACITOR	
39 C28, C29	-	0	N/A	N/A	OPEN	PACKAGE OUTLINE 7343 HEIGHT 4.3MM ELECTROLYTIC CAPACITOR	
40 C38, C51, C57	-	0	N/A	N/A	OPEN	PACKAGE OUTLINE 0402 NON-POLAR CAPACITOR	
41 R13, R17	-	0	N/A	N/A	OPEN	PACKAGE OUTLINE 0402 RESISTOR	
42 C4	-	0	GRM156R71H821K401	KEIEMET/MURATA	820PF	CAPACITOR; SMT (0402); CERAMIC CHIP; 820PF; 50V; TOL=10%; TG=-55 DEGC TO +125 DEGC; TC=X7R	(Alternate part for C4)
43 L1	-	0	744373460047	WURTH ELECTRONICS INC	0.47UH	INDUCTOR; SMT; WIREWOUND CHIP; 0.47UH; TOL=+/-20%; 1.5A	(Alternate part for L1)
TOTA	-	88					

NOTE: DNI-> DO NOT INSTALL(PACKOUT); DNP-> DO NOT PROCURE

MAX38800 EV Kit Schematic

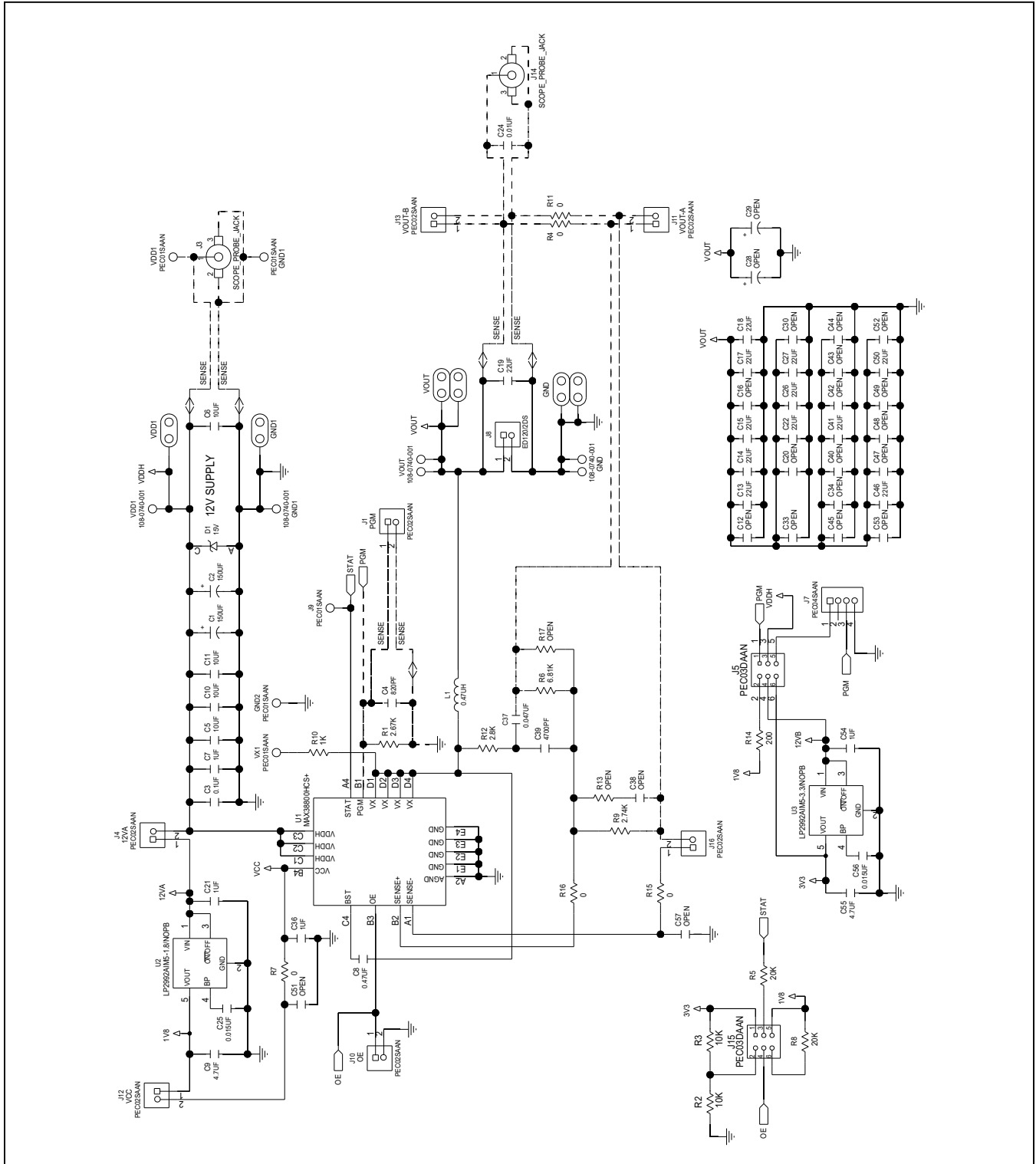

MAX38800 EV Kit PCB Layout Diagrams

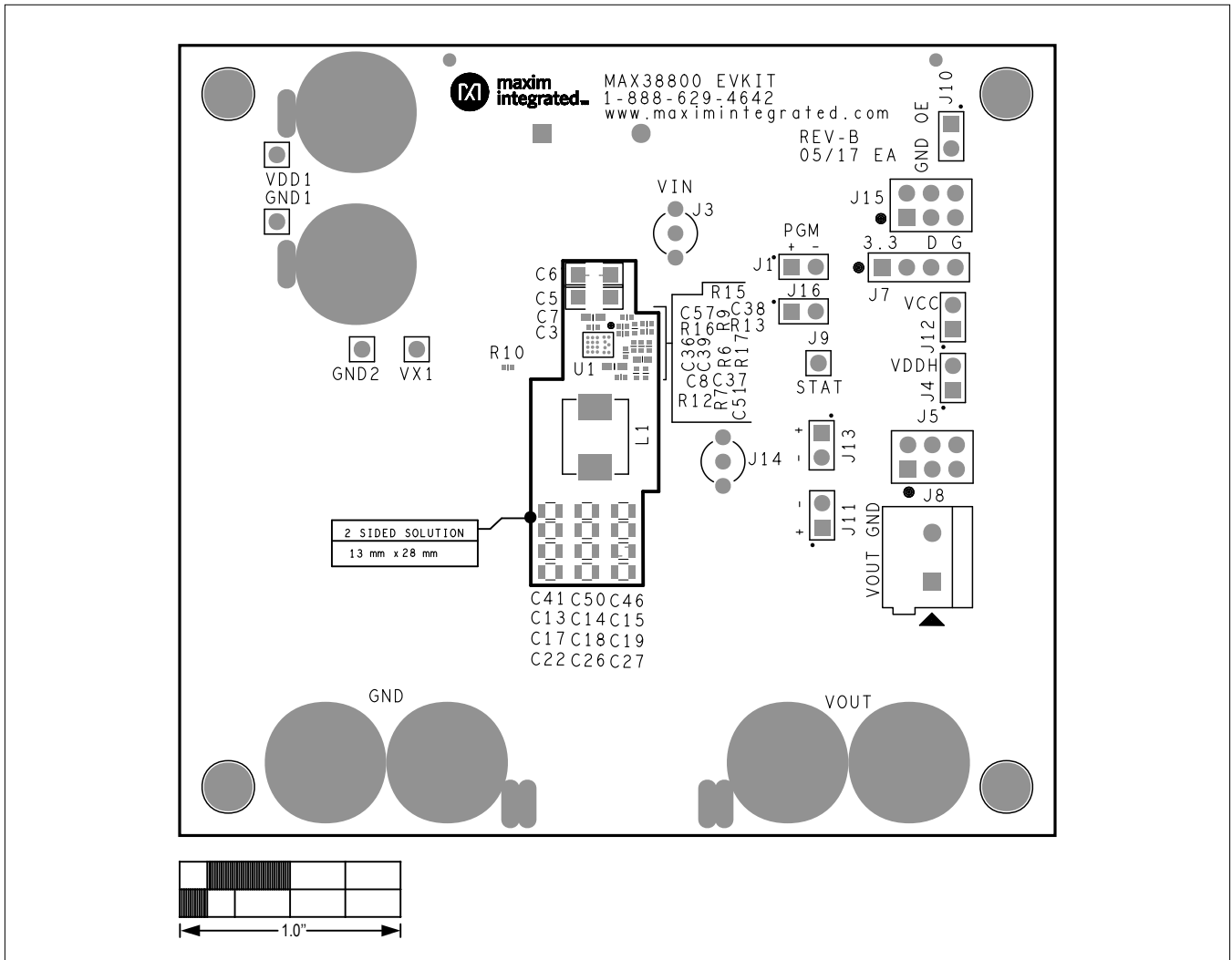

MAX38800 EV Kit—Top Silkscreen



MAX38800 EV Kit PCB Layout Diagrams (continued)

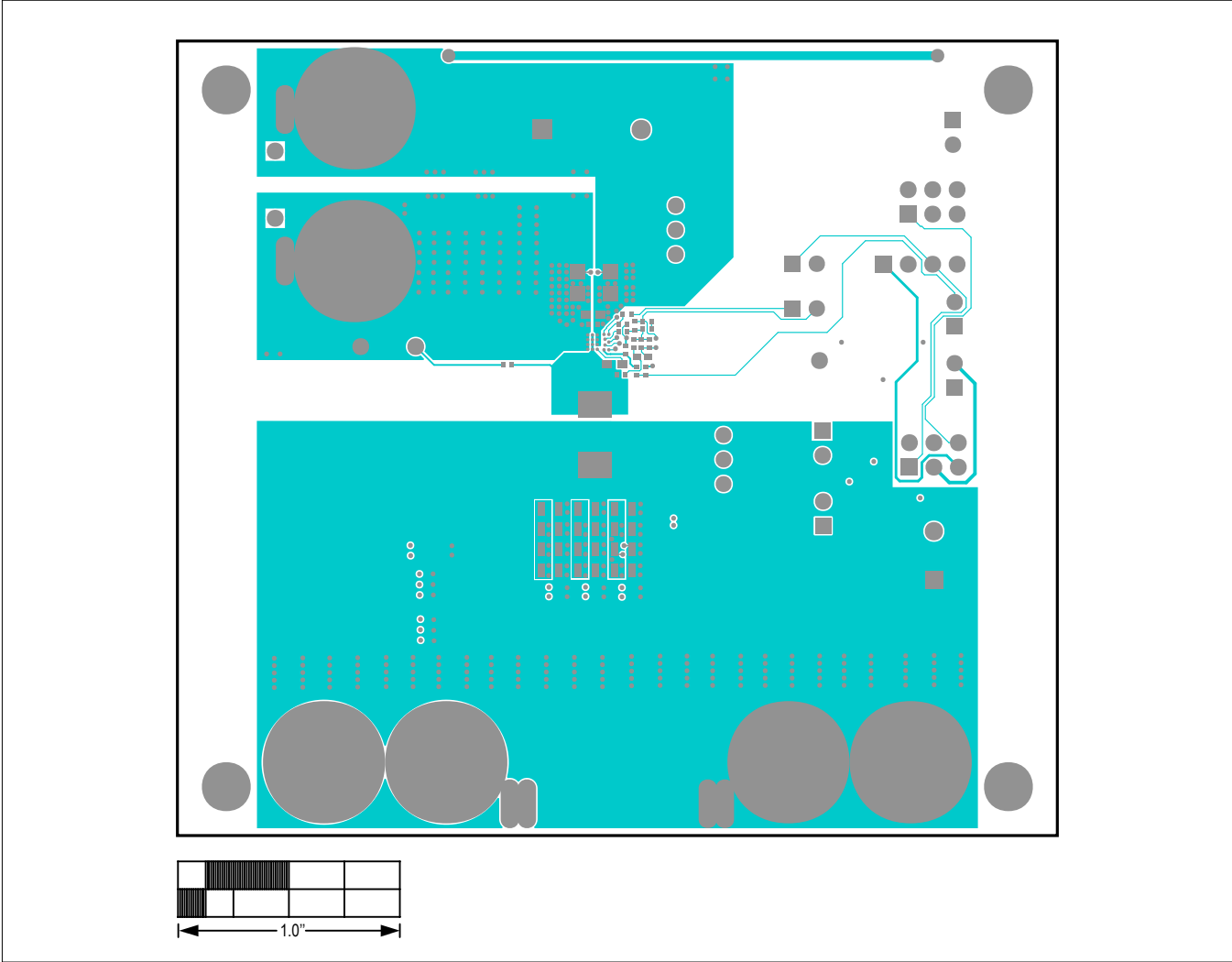

MAX38800 EV Kit—Top View

MAX38800 EV Kit PCB Layout Diagrams (continued)

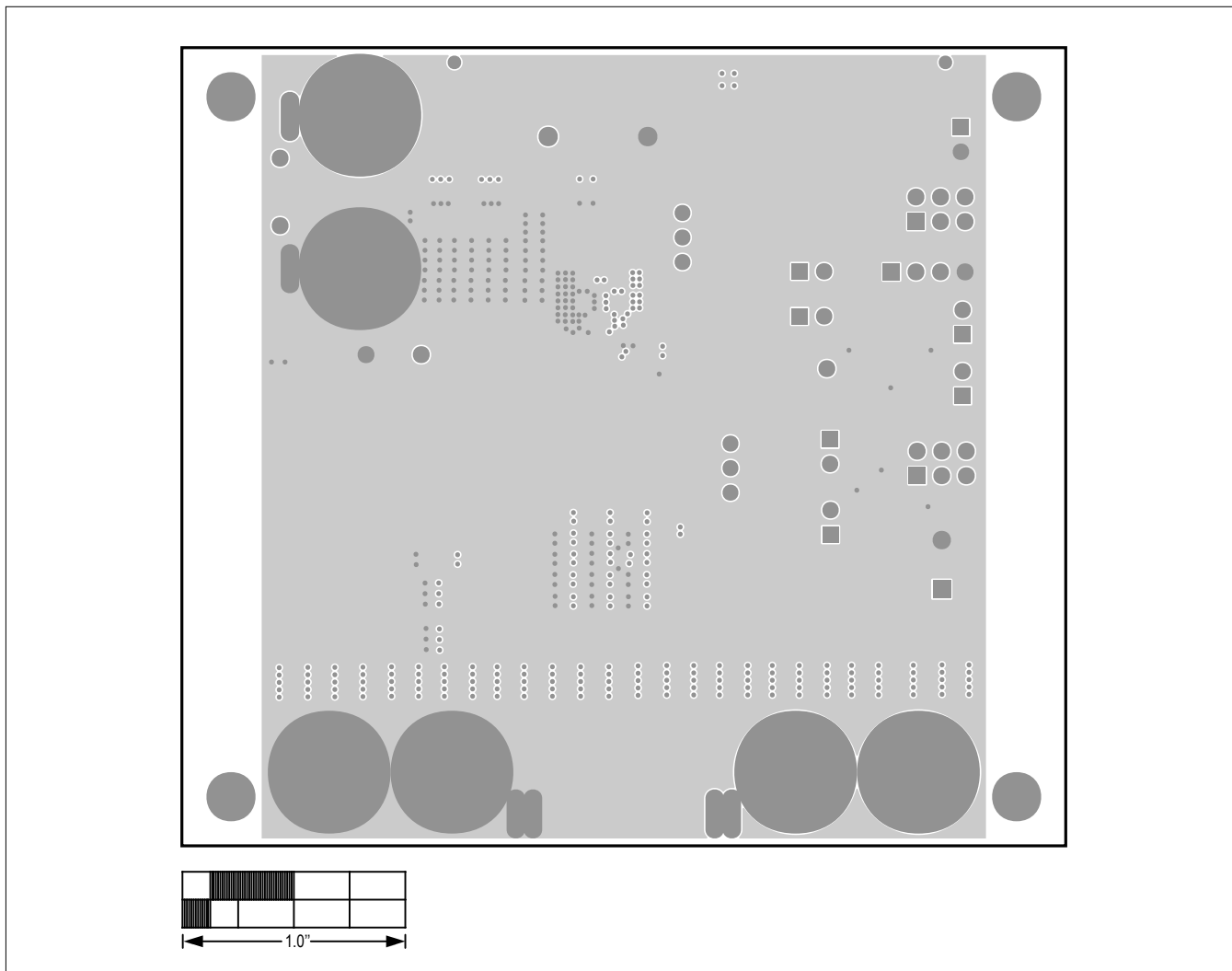

MAX38800 EV Kit—Second Layer

MAX38800 EV Kit PCB Layout Diagrams (continued)

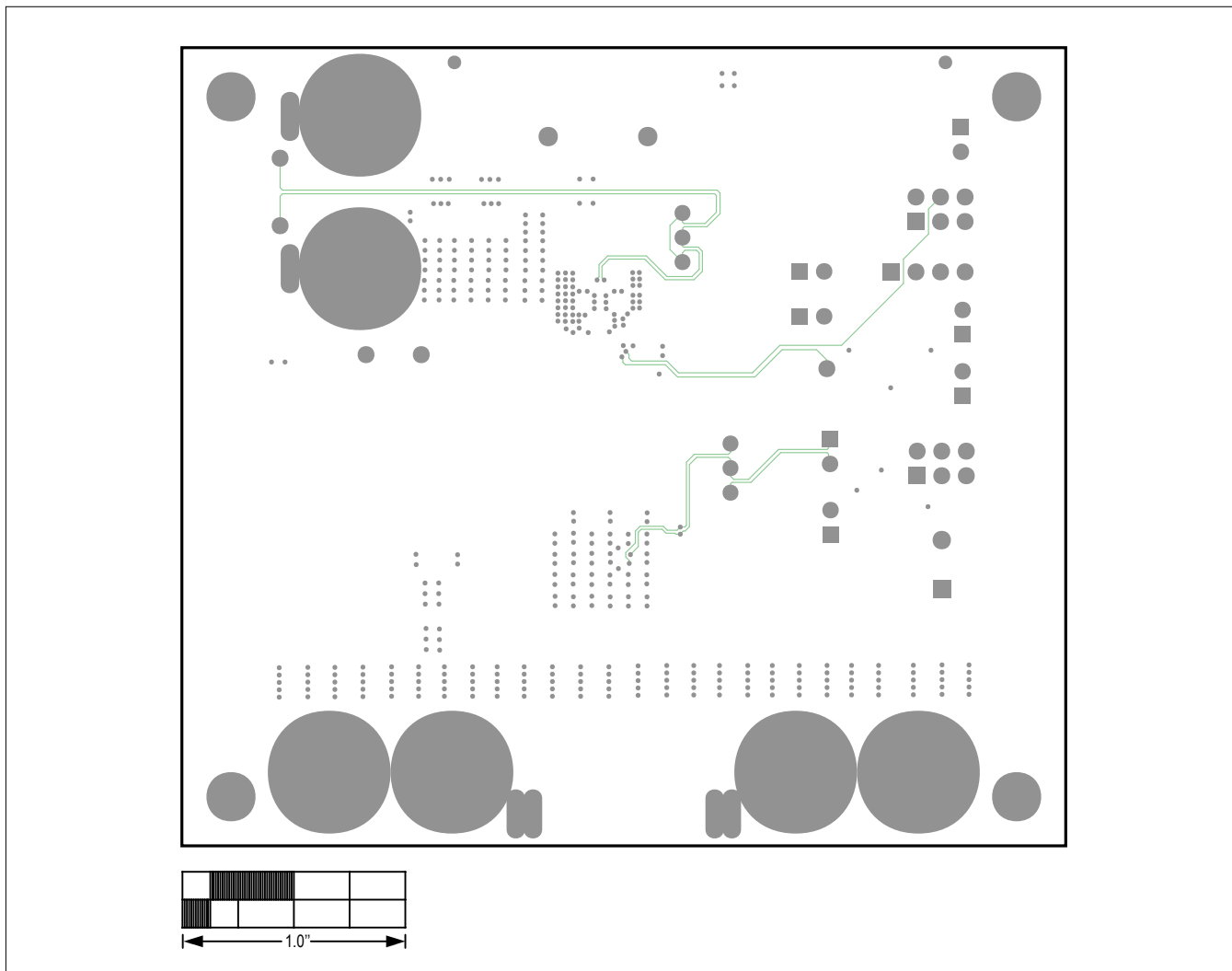

MAX38800 EV Kit—Third Layer

MAX38800 EV Kit PCB Layout Diagrams (continued)

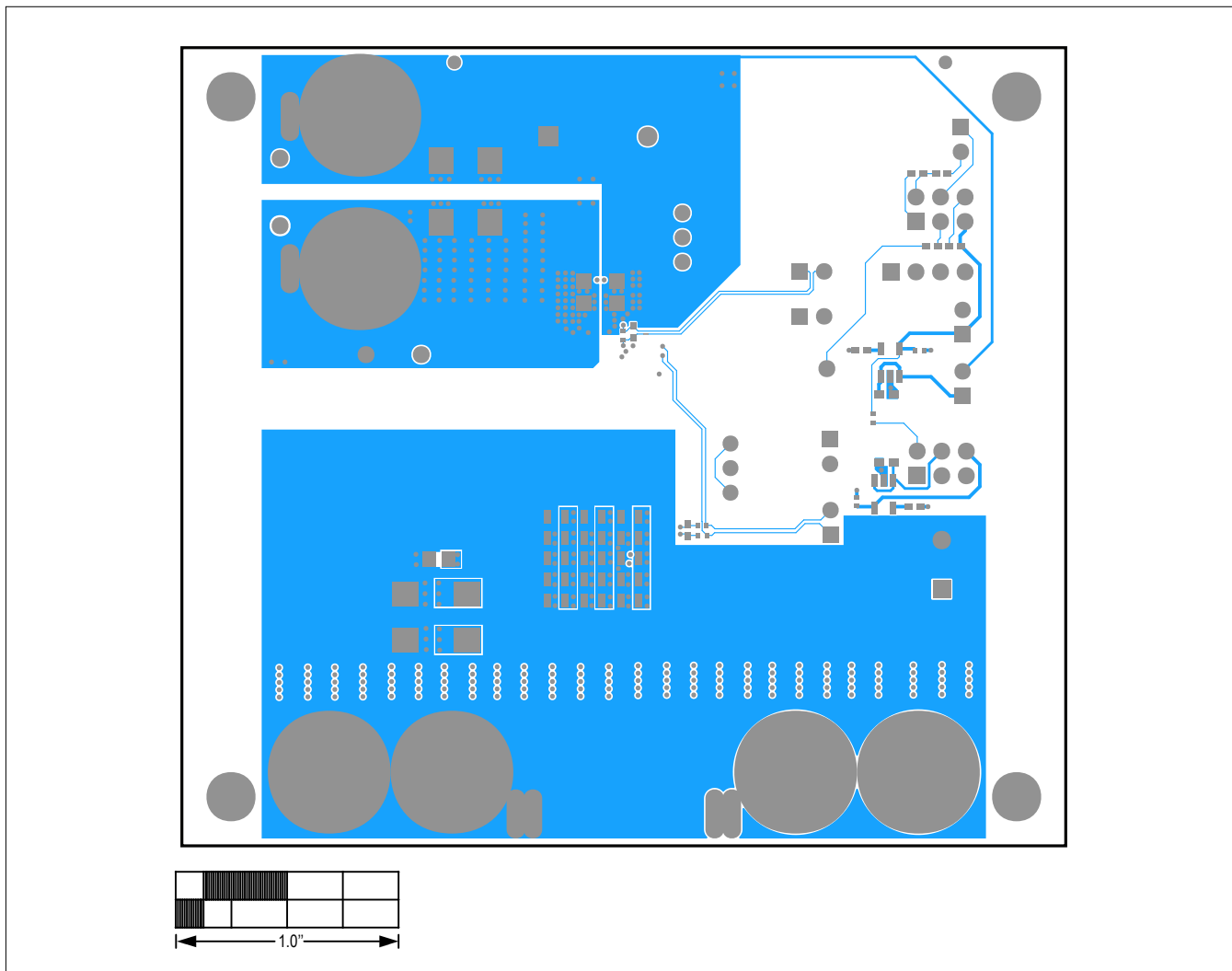

MAX38800 EV Kit—Bottom View

MAX38800 EV Kit PCB Layout Diagrams (continued)

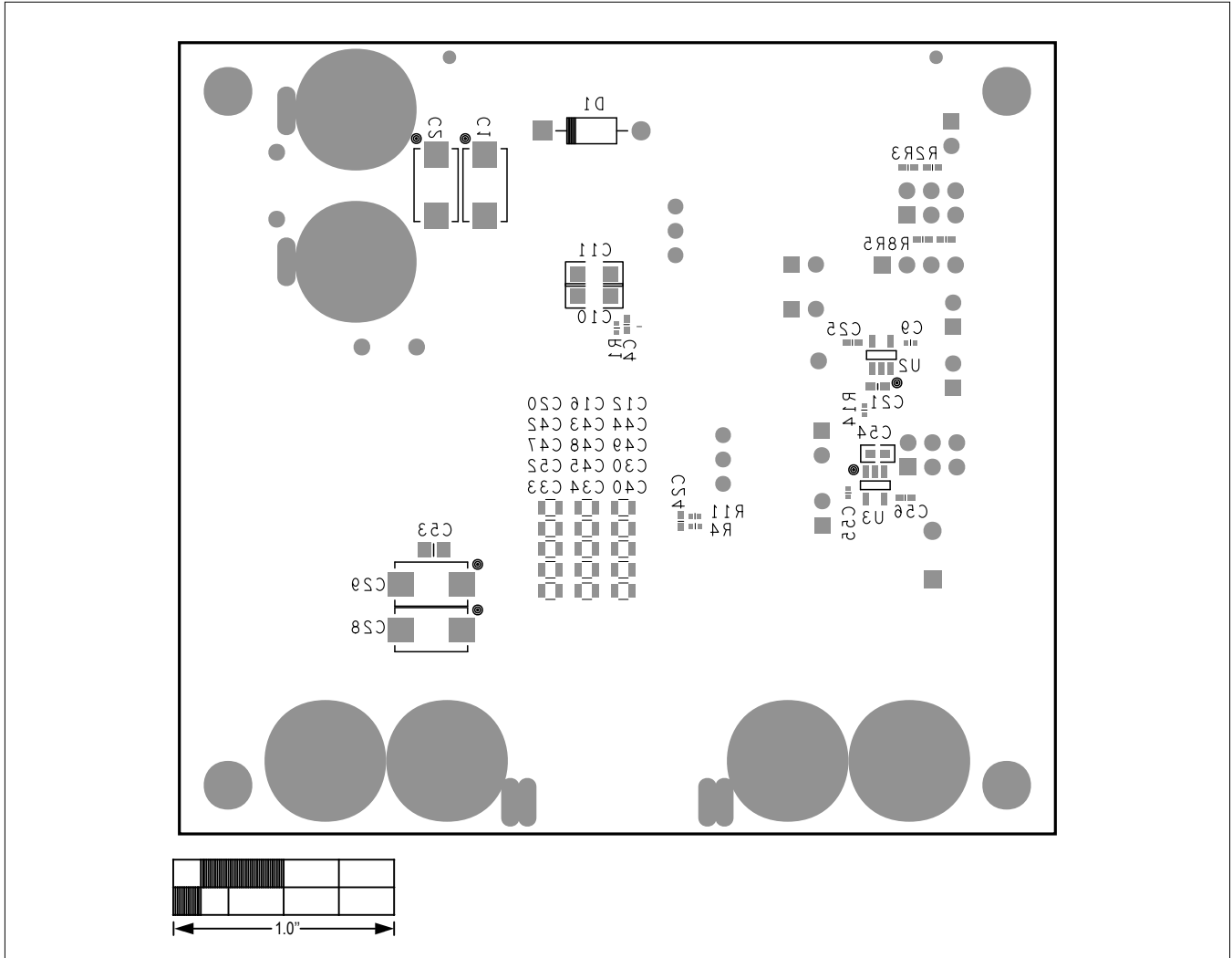

MAX38800 EV Kit—Bottom Silkscreen

### Ordering Information

PART	TYPE
MAX38800EVKIT#	EV Kit

*#Denotes an RoHS-compliant device*

## Revision History

REVISION NUMBER	REVISION DATE	DESCRIPTION	PAGES CHANGED
0	8/17	Initial release	—
1	5/18	Updated Bill of Materials	

For pricing, delivery, and ordering information, please contact Maxim Direct at 1-888-629-4642, or visit Maxim Integrated's website at [www.maximintegrated.com](http://www.maximintegrated.com).

*Maxim Integrated cannot assume responsibility for use of any circuitry other than circuitry entirely embodied in a Maxim Integrated product. No circuit patent licenses are implied. Maxim Integrated reserves the right to change the circuitry and specifications without notice at any time.*

## X-ON Electronics

Largest Supplier of Electrical and Electronic Components

*Click to view similar products for [Power Management IC Development Tools](#) category:*

*Click to view products by [Maxim](#) manufacturer:*

Other Similar products are found below :

[EVB-EP5348UI](#) [MIC23451-AAAYFL EV](#) [MIC5281YMME EV](#) [124352-HMC860LP3E](#) [DA9063-EVAL](#) [ADP122-3.3-EVALZ](#) [ADP130-0.8-EVALZ](#) [ADP130-1.8-EVALZ](#) [ADP1740-1.5-EVALZ](#) [ADP1870-0.3-EVALZ](#) [ADP1874-0.3-EVALZ](#) [ADP199CB-EVALZ](#) [ADP2102-1.25-EVALZ](#) [ADP2102-1.875EVALZ](#) [ADP2102-1.8-EVALZ](#) [ADP2102-2-EVALZ](#) [ADP2102-3-EVALZ](#) [ADP2102-4-EVALZ](#) [AS3606-DB](#) [BQ25010EVM](#) [BQ3055EVM](#) [ISLUSBI2CKIT1Z](#) [LP38512TS-1.8EV](#) [EVAL-ADM1186-1MBZ](#) [EVAL-ADM1186-2MBZ](#) [ADP122UJZ-REDYKIT](#) [ADP166Z-REDYKIT](#) [ADP170-1.8-EVALZ](#) [ADP171-EVALZ](#) [ADP1853-EVALZ](#) [ADP1873-0.3-EVALZ](#) [ADP198CP-EVALZ](#) [ADP2102-1.0-EVALZ](#) [ADP2102-1-EVALZ](#) [ADP2107-1.8-EVALZ](#) [ADP5020CP-EVALZ](#) [CC-ACC-DBMX-51](#) [ATPL230A-EK](#) [MIC23250-S4YMT EV](#) [MIC26603YJL EV](#) [MIC33050-SYHL EV](#) [TPS60100EVM-131](#) [TPS65010EVM-230](#) [TPS71933-28EVM-213](#) [TPS72728YFFEVM-407](#) [TPS79318YEQEVM](#) [UCC28810EVM-002](#) [XILINXPWR-083](#) [LMR22007YMINI-EVM](#) [LP38501ATJ-EV](#)