

MAX38802 Evaluation Kit

Evaluates: MAX38802

General Description

The MAX38802 evaluation kit (EV kit) serves as a reference platform for evaluating the MAX38802 voltage regulator IC. This single-chip, integrated switching regulator provides an extremely compact, highly efficient, fast, accurate, and reliable power-delivery solution for low-output voltage applications. The MAX38802 has different programmability options to enable a wide range of configurations.

The EV kit consists of a fully-assembled and tested Printed Circuit Board (PCB) implementation of the MAX38802. Jumpers, test points, and input/output connectors are included for flexibility and ease-of-use. Refer to the data sheet for ordering information and more details.

Applications

- Servers/ μ Servers
- I/O and Chipset Supplies
- GPU Core Supply
- DDR Memory—VDDQ and VTT
- Point-of-Load (PoL) Applications

Ordering Information appears at end of data sheet.

Features

- High-Efficiency Solution
 - Up to 97% Peak
 - Up to 87% at Full Load
 - Up to 96% Light-Load Efficiency at 1A with DCM Enabled
- Inductor Valley Current Limit is Configured to 16A ($R_SEL = R1 = 6.04k\Omega$)
- Programmable Switching Frequency from 400kHz to 900kHz
- Programmable Positive and Negative OCP Limit
- Programmable Reference Voltage with External Input Option
- Fast Transient Response with Quick-PWM™ Architecture
- Differential Remote Sense with Open-Circuit Detection
- Percentage-Based Output Power Good and OVP
- Open-Drain Status Indicator (STAT) Pin
- Input Undervoltage and Overvoltage Lockout
- Adaptive Dead Time Control
- Integrated Boost Switch
- 27-Bump WLCSP (2.2mm x 3.8mm) Footprint
- Operation Using Ceramic Input and Output Capacitors

Quick-PWM is a trademark of Maxim Integrated Products, Inc.

Quick Start

Required Equipment

- MAX38802 EV kit
- 12V, 10A DC power supply
- Load capable of sinking 16A
- Digital voltmeter
- Oscilloscope

Procedure

The EV kit is fully assembled and tested. Follow the steps below to verify the board operation. **Caution: Do not turn on power supply until all connections are completed.**

- 1) Connect a 12V power supply to the VDD1 and GND1 banana jacks.
- 2) Make sure the shunt is installed on:
 - a) J16 (1-2) to close the sense line.
 - b) J4 (1-2) to power up the on-board LDO which regulates 1.8V.
 - c) J12 (1-2) to provide the 1.8V bias supply to the regulator from the on-board LDO.
 - d) J15 (3-5) to pull up the STAT pin.
 - e) J15 (4-6) to pull up the OE pin.
 - f) J15 (2-4) to pull down/disable the OE pin.
- 3) Connect a voltmeter to the VOUT and GND banana jacks (J8, J11, J13, and J14 can be used as well).
- 4) Turn on the power supply.
- 5) Verify that the voltmeter reads 2.5V.

Detailed Description of Hardware

The MAX38802 EV kit provides compact, high-efficiency power delivery for precision outputs that demand fast transient response. The 27-bump (2.2mm x 3.8mm) WLCSP package minimizes the PCB area. The EV kit is preset for 2.5V output and can provide up to 16A from a 6.5V to 14V input supply.

Bias Supply

The MAX38802 EV kit has an on-board LDO (U2) that can provide the required 1.8V VCC bias voltage to the regulator

as well as the pull-up voltage for the Output Enable (OE) input. This allows testing the part using a single external power supply.

To enable the on-board LDO, install the shunt on jumper J4. To effectively use the LDO to supply the VCC bias voltage to the regulator, also install the shunt on jumper J12.

In order to properly measure the efficiency of the regulator, the LDO should not be active. To disable the LDO, both shunts on J4 and J12 need to be removed. An external 1.8V, 0.1A current limited power supply needs to be connected between J12-2 and ground. The same signal should be connected to J10 (1-2) to pull up the OE pin.

Regulator enable

To enable the regulator, the OE pin needs to be pulled high. If the on-board 1.8V LDO is active (the shunt on jumper J4 is in place), its output voltage can be used for the purpose. Installing a shunt on J15 (4-6) pulls the OE signal high to 1.8V through a 20k Ω resistor. To shut down the regulator, a shunt needs to be installed on J10. This forces the OE pin low.

Status Pin

The MAX38802 has an open collector status (STAT) output to report fault or output undervoltage and output overvoltage event. Install a shunt on J15 (3-5) to pull up this pin to VCC through a 20k Ω resistor. Since the STAT pin is 1.8V tolerant, a shunt on J15 (1-3) can be installed to pull up this pin through a 20k Ω resistor to the 1.8V provided by the on-board regulator U2.

Scenario Selection

Several parameters of the MAX38802 can be programmed to allow optimization for specific applications. By selecting the appropriate value of resistor R_SEL (R1) and capacitor C_SEL (C4), the optimum set of parameters (scenario) can be programmed.

While R_SEL selects the proper scenario, C_SEL determines the nominal F_{SW}. [Table 1](#) shows the configuration table for MAX38802.

Setting the Output Voltage

The output voltage of the MAX38802 depends both on the reference voltage (V_{REF}) and the resistor divider ratio.

Equation 1

$$V_{OUT} = V_{REF} \times \left(1 + \frac{R_6}{R_9} \right)$$

The reference voltage is selected through RSEL (see [Table 1](#)) and can be either internal or external (refer to the data sheet for more details). In order to optimize the common mode rejection of the error amplifier, choose the voltage divider resistors so that their parallel resistance R_{PAR} is as close as possible to $2k\Omega$.

Equation 2

$$R_6 = V_{OUT} \times \left(\frac{R_{PAR}}{V_{REF}} \right)$$

$$R_9 = R_6 \times \left(\frac{R_{PAR}}{R_6 - R_{PAR}} \right)$$

where,

R_6 = Top divider resistor

R_9 = Bottom divider resistor

R_{PAR} = Desired parallel resistance of R_6 and R_9

V_{OUT} = Output voltage

V_{REF} = Reference voltage

Operation with External V_{REF}

When using an external reference adopt the configuration shown in [Figure 1](#). Once OE is asserted, the regulator briefly discharges the SENSE- node and releases it as regulation begins. In this case, the soft-start ramp is determined by the external low-pass filter time constant. The external filter time constant needs to be lower than $T_{SS}/3$ in order to avoid premature assertion of the STAT pin while the output voltage is still ramping.

The external reference voltage can be applied prior to enabling the regulator, or ramped up right after enable is asserted. In both cases, the low-pass filtered reference voltage at SENSE- pin must reach its final value within T_{SS} .

Typical values for the filter components are:

- $R_F = 2.2k\Omega$
- $C_F = 0.22\mu F$

Table 1. MAX38802 Configuration Table

R_SEL (kΩ)	VREF (V)	SOFT-START TIME (T _{SS}) (ms)	VALLEY OCP INCEPTION (A)	OPERATION MODES	REPORTING (CURRENT/TEMP)	RSENSE (GAIN) (mΩ)	Fsw (kHz)			TSTAT (μs)						
							C_SEL									
							0pF	200pF	820pF							
1.78	0.95	6	16	CCM	Current	2.8	700	800	900	2000						
2.67				CCM/DCM												
4.02				CCM												
6.04				CCM/DCM												
9.09	Ext.	1.5	16	CCM												
13.3																
20.0	0.6	6	24	CCM/DCM							Temp	1.4	400	500	600	128
30.9				CCM												
46.4			16	CCM/DCM												
71.5				CCM/DCM												
107				CCM/DCM												
162	Ext.	1.5	20	CCM	Temp											

Input Voltage Monitoring

VDD1 and GND1 sense points as well as J3 can be used to monitor the input supply.

Output Voltage Monitoring

J11 and J13 monitor the output voltage. These test points should not be used for loading. Use scopejack J14 to monitor the output voltage ripple on an oscilloscope.

Efficiency Measurement

The following steps describe how to measure the regulator efficiency.

- 1) Connect a 12V power supply to the VDD1 and GND1 banana jacks. To avoid the input voltage to drop at high load due to power losses on connection cables connect the sense lines of the power supply to VDD1 and GND1 headers.
- 2) Connect an external 1.8V, 0.1A current limited power supply between J12-2 and ground
- 3) Connect the same power supply to J10-1 to enable the regulator.

- 4) Connect a load to the VOUT and GND banana jacks for better results. J8 can also be used for low currents.
- 5) Make sure the shunt is installed on J16 (1-2) to close the sense line.
- 6) Remove all the other jumpers.
- 7) Connect a voltmeter to J11 or J13
- 8) Turn on the power supply.
- 9) Measure V_{IN} , I_{IN} , V_{OUT} , I_{OUT} , V_{BIAS} , and I_{BIAS} .
- 10) Calculate the efficiency as:

Equation 3

$$\eta = \left(\frac{V_{OUT} \times I_{OUT}}{(V_{IN} \times I_{IN}) + (V_{BIAS} \times I_{BIAS})} \right)$$

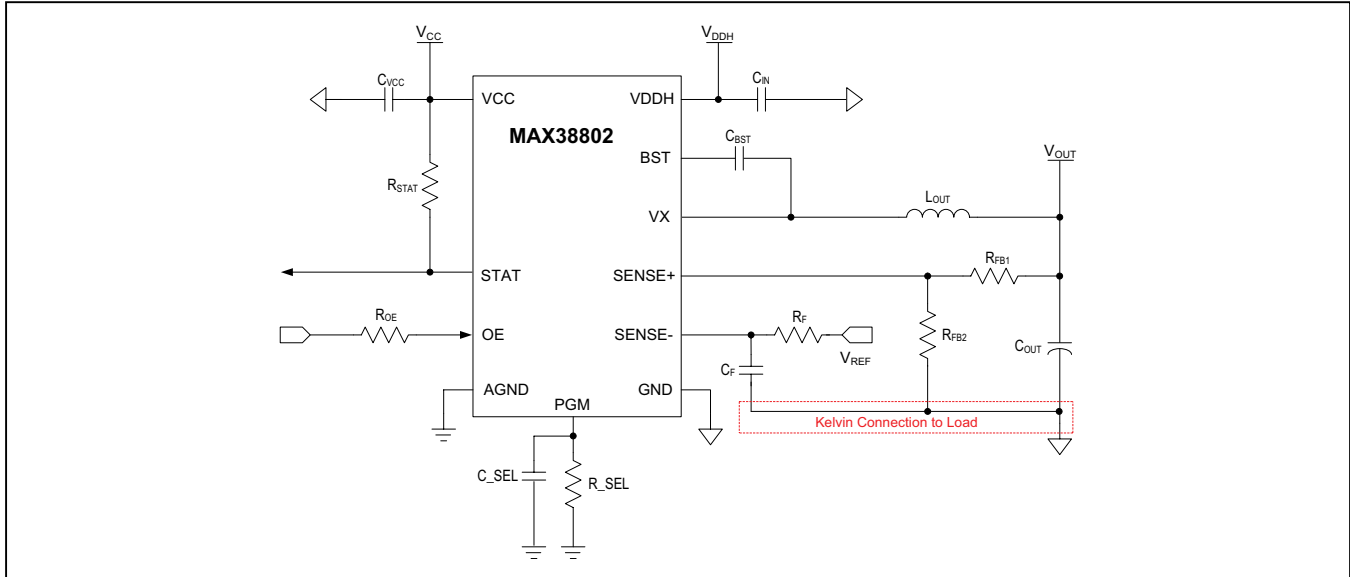

Figure 1. Electrical Connections to Use the External Voltage Reference Feature

MAX38802 EV Kit Bill of Materials

ITEM	QTY	REF DES	MAXINV	MFG PART #	MANUFACTURER	VALUE	DESCRIPTION	STATUS
1	2	C1, C2	20-0150U-00	TPSE157M016R0100	AVX	150µF	CAP: SMT (7343); 150µF; 20%; 16V; TANTALUM	ACTIVE
2	1	C3	20-000U1-L1A	C1005X7R1C104K050BC; ATC530L-104KT16; 0402YC104KATZA; C0402X7R160-104KNE; CL05B104K05NNC; GRM155R71C104K488; C1005X7R1C104K; CC0402KRXR7BB104; EMK105B7104KV; CL05B104KC05	TDK; AMERICAN TECHNICAL CERAMICS; AVX; VENKEL LTD.; SAMSUNG ELECTRONICS; MURATA; TDK; YAGEO PHICOMP; TAIYO YUDEN; SAMSUNG ELECTRONICS	0.1µF	CAP: SMT (0402); 0.1µF; 10%; 16V; X7R; CERAMIC	ACTIVE
3	1	C4	20-0820P-12	ECJ-J1EB1E821K	PAWASONIC	820PF	CAP: SMT (0402); 820PF; 10%; 25V; X7R; CERAMIC	EVKIT-NOT FOR TEST
4	4	C5, C6, C10, C11	20-0010U-A36	C3216X7R1C106M160AC	TDK	10µF	CAP: SMT (1206); 10µF; 20%; 16V; X7R; CERAMIC	EVKIT-NOT FOR TEST
5	1	C7	20-0001U-A54	EMK107B7105MA	TAIYO YUDEN	1µF	CAP: SMT (0603); 1µF; 20%; 16V; X7R; CERAMIC	EVKIT-NOT FOR TEST
6	1	C8	20-00047-P6	GRM188R71E474K12; CCM188R71E474K64	MURATA; MURATA	0.47µF	CAP: SMT (0603); 0.47µF; 10%; 25V; X7R; CERAMIC	EVKIT-NOT FOR TEST
7	2	C9, C21	20-0010U-BA12	GRM155R61A106ME44; GRM155R61A106ME11; 0402ZD106MATZA; CL05A106MP5NUNC	MURATA; MURATA; AVX; SAMSUNG	10µF	CAP: SMT (0402); 10µF; 20%; 10V; X5R; CERAMIC	ACTIVE
8	5	C13-C15, C17, C18	20-0022U-K7A	C2012X6S0J226M125AB; GRM12BC80U	TDK; MURATA	22µF	CAP: SMT (0805); 22µF; 20%; 6.3V; X6S; CERAMIC	EVKIT-NOT FOR TEST
9	4	C22, C41, C46, C50	20-0047U-K7D	CL21A476MQYNNI; C2012X6S0J476M125AC; JMK212BL476MG	SAMSUNG ELECTRONICS; TDK; TAIYO YUDEN	47µF	CAP: SMT (0805); 47µF; 20%; 6.3V; X5R; CERAMIC	EVKIT-NOT FOR TEST
10	1	C23	20-0U015-B19	C0402C153K4FRAC; GRM155R71C153K401	KEMET; MURATA	0.015µF	CAP: SMT (0402); 0.015µF; 10%; 16V; X7R; CERAMIC	ACTIVE
11	1	C24	20-000U1-12	C0402C103K3FRAC; GRM155R71E103K401; C1005X7R1E103K050BB	KEMET; MURATA; TDK	0.01µF	CAP: SMT (0402); 0.01µF; 10%; 25V; X7R; CERAMIC; NOTE: NOT RECOMMENDED FOR NEW DESIGN. USE 20-00u01-B60	NOT RECOMMENDED

MAX38802 EV Kit Bill of Materials (continued)

ITEM	QTY	REF DES	MAXIMV	MFG PART #	MANUFACTURER	VALUE	DESCRIPTION	STATUS
12	1	C36	20-0001U-19	C0402X5R6R3-105KNP; C1005X5R0J105K050BB; GRM155R60J105KE19; JMK105B1105KV-F; JMK105B1105KH-F	VENKEL LTD; TDK; MURATA; TAIYO YUDEN; TAIYO YUDEN	1µF	CAP: SMT (0402); 1µF; 10%; 6.3V; X5R; CERAMIC; NOTE: NOT RECOMMENDED FOR NEW DESIGN. USE 20-0001U-BB	NOT RECOMMENDED
13	1	C37	20-6800P-BA43	TMK105B1682KVH	TAIYO YUDEN	6800PF	CAP: SMT (0402); 6800PF; 10%; 25V; X8R; CERAMIC	EVKIT-NOT FOR TEST
14	1	C38	20-0J015-04C	GRM155R71H153KA12	MURATA	0.015µF	CAP: SMT (0402); 0.015µF; 10%; 50V; X7R; CERAMIC	EVKIT-NOT FOR TEST
15	1	C39	20-2200P-12	C0402C22K3RAC	KEMET	2200PF	CAP: SMT (0402); 2200PF; 10%; 25V; X7R; CERAMIC; NOTE: NOT RECOMMENDED FOR NEW DESIGN. USE 20-2200P-04	NOT RECOMMENDED
16	1	D1	30-2EZ15D5-00	2EZ15D5	MICRO COMMERCIAL COMPONENTS	15V	DIODE: ZNR; THROUGH HOLE-AXIAL LEAD (DO-41); VZ = 15V; IZ = 0.122A	EVKIT-NOT FOR TEST
17	6	GND1, TP1-TP3, VDD1, VOUT	01-10807400011P-80	108-0740-001	EMERSON NETWORK POWER	108-0740-001	CONNECTOR; MALE; PANEL MOUNT; BANANA JACK; STRAIGHT; 1PIN	EVKIT-NOT FOR TEST
18	5	GND1_HEADER, GND2, J9, VDD1_HEADER, VX1	01-PEC01SAAN1P-21	PEC01SAAN	SULLINS ELECTRONICS CORP	PEC01SAAN	CONNECTOR; MALE; THROUGH HOLE; BREAKAWAY; STRAIGHT; 1PIN	EVKIT-NOT FOR TEST
19	7	J1, J4, J10-J13, J16	01-PEC02SAAN2P-21	PEC02SAAN	SULLINS	PEC02SAAN	CONNECTOR; MALE; THROUGH HOLE; BREAKAWAY; STRAIGHT; 2PINS	ACTIVE
20	2	J3, J14	00-SAMPLE-01	SCOPE_PROBE_JACK	MAXIM	SCOPE_PROBE_JACK	EVKIT PART: SCOPE_PROBE_JACK	EVKIT-CUSTOM
21	1	J8	01-ED1202DS2P-25	ED1202DS	ON-SHORE TECHNOLOGY INC.	ED1202DS	CONNECTOR; FEMALE; THROUGH HOLE; BLUE TERMINAL BLOCK; STRAIGHT; 2PINS	EVKIT-NOT FOR TEST
22	1	J15	01-PEC03DAAN6P-21	PEC03DAAN	SULLINS ELECTRONICS CORP.	PEC03DAAN	CONNECTOR; MALE; THROUGH HOLE; BREAKAWAY; STRAIGHT THROUGH; 6PINS; -65°C TO +125°C	ACTIVE
23	1	L1	50-00U68-000	744373680068	WURTH ELECTRONICS INC	0.68µH	INDUCTOR; SMT; SHIELDED; 0.68µH; TOL = ±20%; 16A	NOT RECOMMENDED
24	1	R1	80-06K04-18A	ERJ-2RKF6041	PANASONIC	6.04K	RES: SMT (0402); 6.04K; 1%; ±100PPM/°C; 0.1000W	EVKIT-NOT FOR TEST
25	1	R2	80-0010K-23D	CRG0402F-10K	TE CONNECTIVITY	10K	RES: SMT (0402); 10K; 1%; ±100PPM/°C; 0.0630W	EVKIT-NOT FOR TEST

MAX38802 EV Kit Bill of Materials (continued)

ITEM	QTY	REF DES	MAXIMV	MFG PART #	MANUFACTURER	VALUE	DESCRIPTION	STATUS
26	2	R3, R13	80-002K1-23	CRCW04022K10FK	VISHAY DALE	2.1K	RES: SMT (0402); 2.1K; 1%; ±100PPM/°C; 0.0630W	ACTIVE
27	5	R4, R7, R11, R15, R16	80-0000R-26B	RC0402JR-070RL; CRC0402-16W-000RJT	YAGEO PRCYCOMP; VENKEL LTD.	0	RES: SMT (0402); 0.5%; JUMPER; 0.0630W	EVKIT-NOT FOR TEST
28	2	R5, R8	80-0020K-06	ERJ-2GEJ203	PANASONIC	20K	RES: SMT (0402); 20K; 5%; ±200PPM/°C; 0.1000W	EVKIT-NOT FOR TEST
29	1	R6	80-04K32-23	CRCW04024K32FK	VISHAY DALE	4.32K	RES: SMT (0402); 4.32K; 1%; ±100PPM/°C; 0.0630W	ACTIVE
30	1	R9	80-02461-4A23	ERJ-2RKF2611	PANASONIC	2.61K	RES: SMT (0402); 2.61K; 1%; ±100PPM/°C; 0.1000W	EVKIT-NOT FOR TEST
31	1	R10	80-0001K-48	CRCW04021K00JK	VISHAY DALE	1K	RES: SMT (0402); 1K; 5%; ±100PPM/°K; 0.0630W	EVKIT-NOT FOR TEST
32	1	R12	80-09K09-23	CR0402-16W-9091FT; CRCW04029K09FK	VENKEL LTD.; VISHAY DALE PANASONIC	9.09K	RES: SMT (0402); 9.09K; 1%; ±100PPM/°C; 0.0630W	ACTIVE
33	1	R18	80-0118K-18A	ERJ-2RKF1183	PANASONIC	118K	RES: SMT (0402); 118K; 1%; ±100PPM/°C; 0.1000W	EVKIT-NOT FOR TEST
34	1	R19	80-0059K-23	CR0402-16W-5902FT; CRCW040259K0FK	VENKEL LTD.; VISHAY DALE	59K	RES: SMT (0402); 59K; 1%; ±100PPM/°K; 0.0630W	EVKIT-NOT FOR TEST
35	5	SU1-SU5	02-JMPFS1100B-00	S1100-B-SX1100-B-STC02SYAN	KYCON; KYCON; SULLINS ELECTRONICS CORP.	SX1100-B	TEST POINT; JUMPER; STR; TOTAL LENGTH = 0.24IN; BLACK; INSULATION = PBT; PHOSPHOR BRONZE CONTACT = GOLD PLATED	EVKIT-NOT FOR TEST
36	1	U1	NA	MAX38802HCJ+	MAXIM	MAX38802HCJ+	EVKIT PART-IC; VREG; INTEGRATED; STEP-DOWN SWITCHING REGULATOR; VT2492; CSP27	EVKIT-CUSTOM
37	1	U2	10-MAX17651AZT-Z	MAX17651AZT+	MAXIM	MAX17651AZT+	IC; REG. UL TRAIL-LOW QUIESCENT CURRENT; LINEAR REGULATOR; TSO16	EVKIT-NOT FOR TEST
TOTAL	75							

MAX38802 EV Kit Schematic

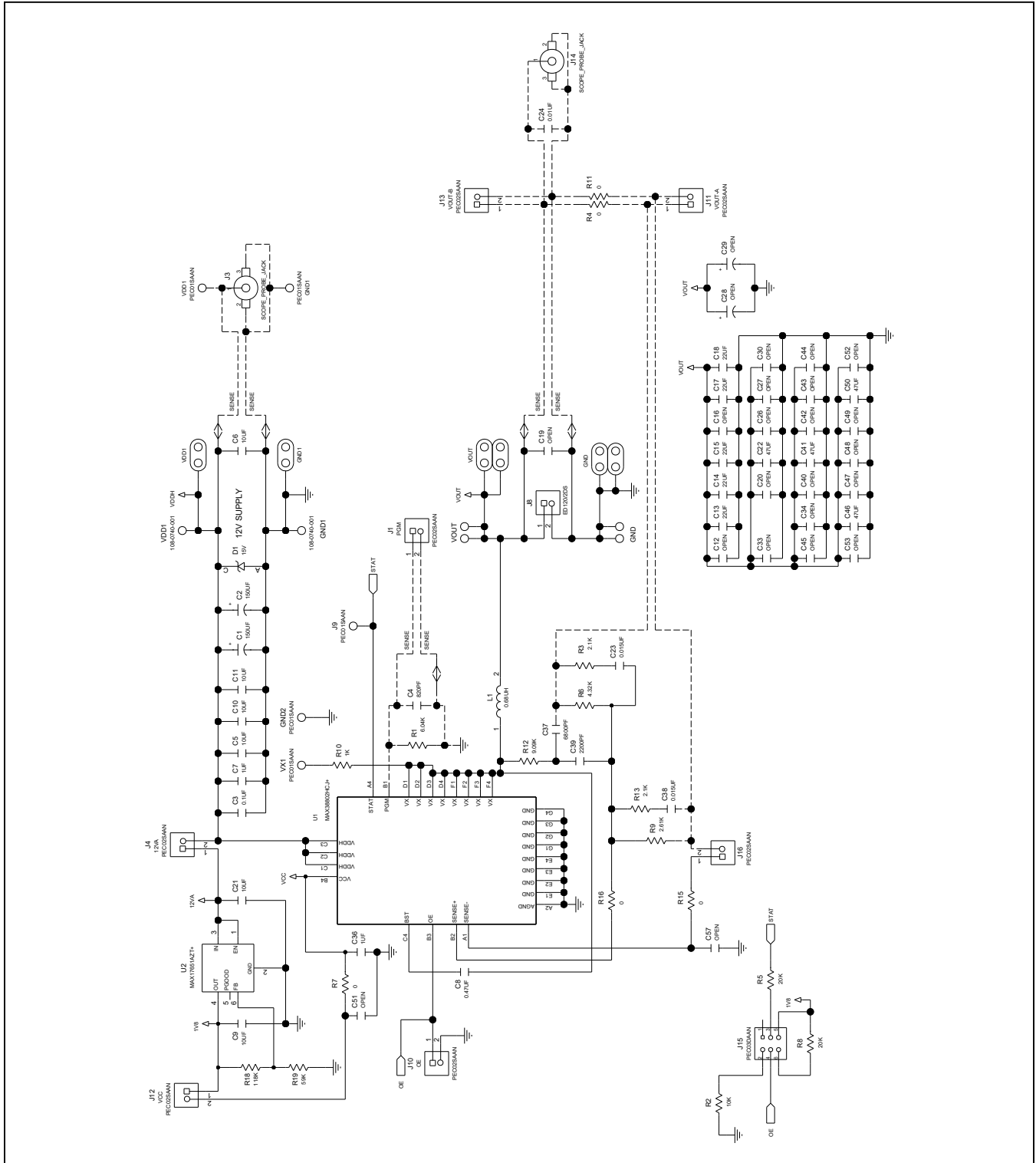

MAX38802 EV Kit PCB Layout Diagrams

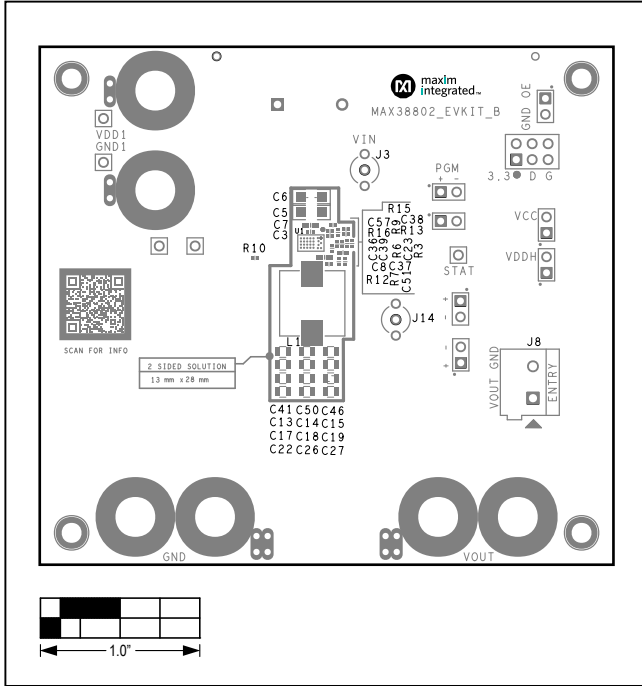

MAX38802 EV Kit—Top Silkscreen

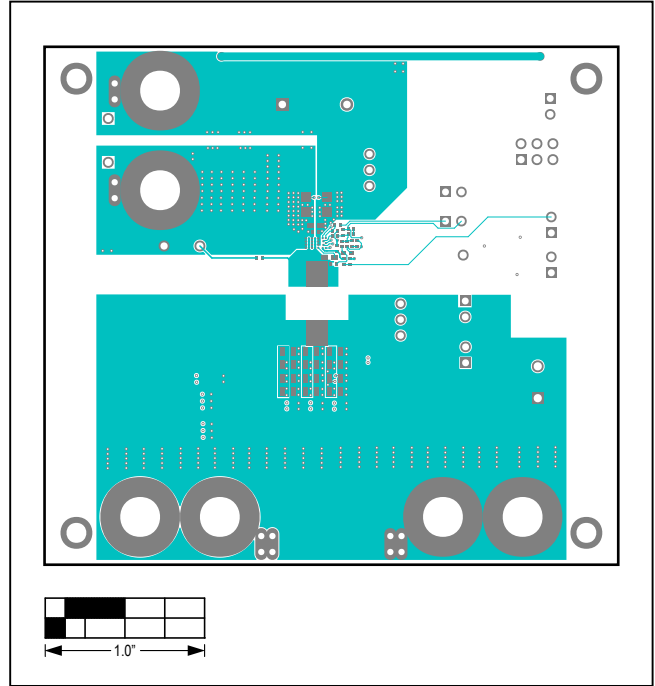

MAX38802 EV Kit—Top

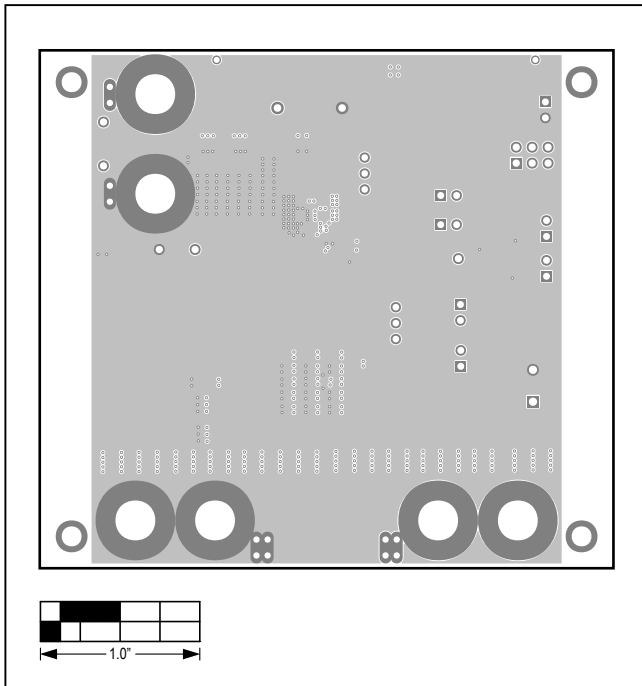

MAX38802 EV Kit—Internal 2

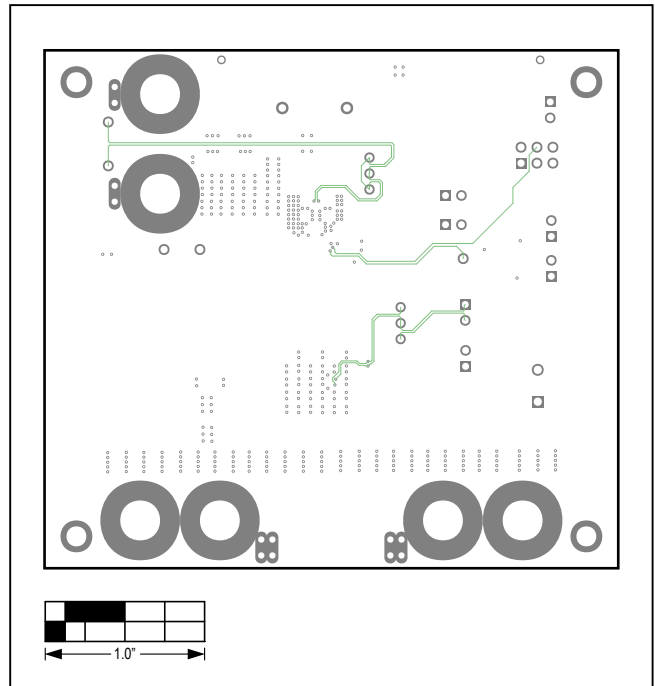

MAX38802 EV Kit—Internal 3

MAX38802 EV Kit PCB Layout Diagrams (continued)

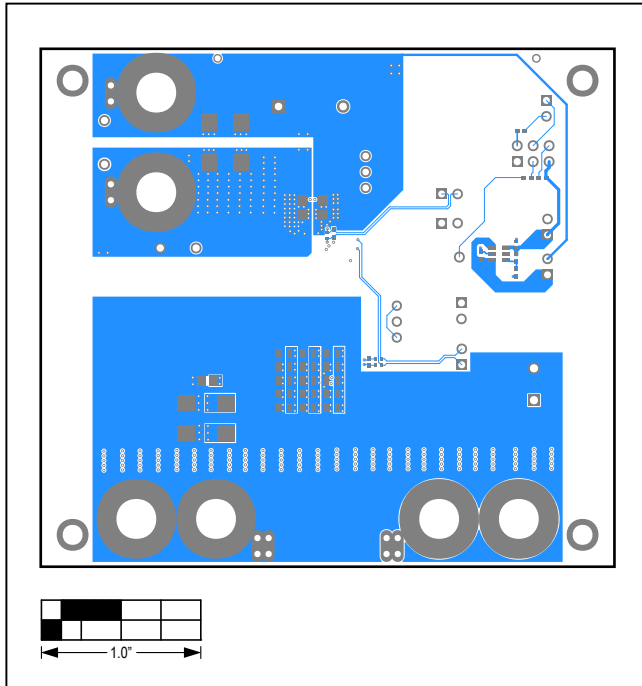

MAX38802 EV Kit—Bottom

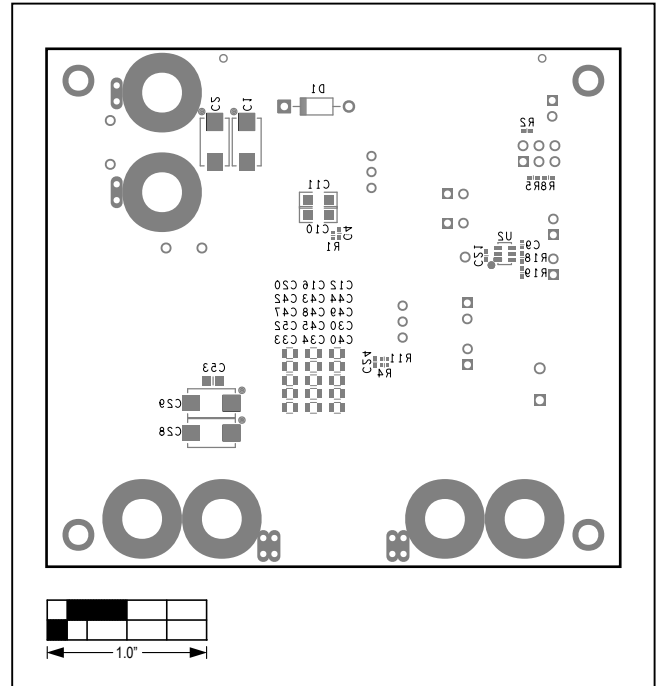

MAX38802 EV Kit—Bottom Silkscreen

Ordering Information

PART	TYPE
MAX38802EVKIT#	EV Kit

#Denotes an RoHS-compliant device

Revision History

REVISION NUMBER	REVISION DATE	DESCRIPTION	PAGES CHANGED
0	8/17	Initial release	—
1	5/18	Updated <i>Bill of Materials</i>	5–7
2	10/20	Updated <i>Procedure, Status Pin, MAX38802 EV Kit Bill of Materials, MAX38802 EV Kit Schematic, and MAX38802 EV Kit PCB Layout Diagrams</i>	2, 5–10

For pricing, delivery, and ordering information, please visit Maxim Integrated's online storefront at <https://www.maximintegrated.com/en/storefront/storefront.html>.

Maxim Integrated cannot assume responsibility for use of any circuitry other than circuitry entirely embodied in a Maxim Integrated product. No circuit patent licenses are implied. Maxim Integrated reserves the right to change the circuitry and specifications without notice at any time.

X-ON Electronics

Largest Supplier of Electrical and Electronic Components

Click to view similar products for [Power Management IC Development Tools](#) category:

Click to view products by [Maxim](#) manufacturer:

Other Similar products are found below :

[EVAL-ADM1168LQEBZ](#) [EVB-EP5348UI](#) [MIC23451-AAAYFL EV](#) [MIC5281YMME EV](#) [DA9063-EVAL](#) [ADP122-3.3-EVALZ](#) [ADP130-0.8-EVALZ](#) [ADP130-1.2-EVALZ](#) [ADP130-1.5-EVALZ](#) [ADP130-1.8-EVALZ](#) [ADP1712-3.3-EVALZ](#) [ADP1714-3.3-EVALZ](#) [ADP1715-3.3-EVALZ](#) [ADP1716-2.5-EVALZ](#) [ADP1740-1.5-EVALZ](#) [ADP1752-1.5-EVALZ](#) [ADP1828LC-EVALZ](#) [ADP1870-0.3-EVALZ](#) [ADP1871-0.6-EVALZ](#) [ADP1873-0.6-EVALZ](#) [ADP1874-0.3-EVALZ](#) [ADP1882-1.0-EVALZ](#) [ADP199CB-EVALZ](#) [ADP2102-1.25-EVALZ](#) [ADP2102-1.875EVALZ](#) [ADP2102-1.8-EVALZ](#) [ADP2102-2-EVALZ](#) [ADP2102-3-EVALZ](#) [ADP2102-4-EVALZ](#) [ADP2106-1.8-EVALZ](#) [ADP2147CB-110EVALZ](#) [AS3606-DB](#) [BQ24010EVM](#) [BQ24075TEVM](#) [BQ24155EVM](#) [BQ24157EVM-697](#) [BQ24160EVM-742](#) [BQ24296MEVM-655](#) [BQ25010EVM](#) [BQ3055EVM](#) [NCV891330PD50GEVB](#) [ISLUSBI2CKIT1Z](#) [LM2744EVAL](#) [LM2854EVAL](#) [LM3658SD-AEV/NOPB](#) [LM3658SDEV/NOPB](#) [LM3691TL-1.8EV/NOPB](#) [LM4510SDEV/NOPB](#) [LM5033SD-EVAL](#) [LP38512TS-1.8EV](#)