



Ultra-Low-Distortion, +5V, 400MHz Op Amps with Disable

MAX4265-MAX4270

General Description

The MAX4265–MAX4270 ultra-low distortion, voltage-feed-back op amps are capable of driving a 100Ω load while maintaining ultra-low distortion over a wide bandwidth. They offer superior spurious-free dynamic range (SFDR) performance: -90dBc at 5MHz and -59dBc at 100MHz (MAX4269). Additionally, input voltage noise density is 8nV/√Hz while operating from a single +4.5V to +8.0V supply or from dual ±2.25V to ±4.0V supplies. These features make the MAX4265–MAX4270 ideal for use in high-performance communications and signal-processing applications that require low distortion and wide bandwidth.

The MAX4265 single and MAX4268 dual amplifiers are unity-gain stable. The MAX4266 single and MAX4269 dual amplifiers are compensated for a minimum stable gain of +2V/V, while the MAX4267 single and MAX4270 dual amplifiers are compensated for a minimum stable gain of +5V/V.

For additional power savings, these amplifiers feature a low-power disable mode that reduces supply current and places the outputs in a high-impedance state. The MAX4265/MAX4266/MAX4267 are available in a space-saving 8-pin μMAX® package, and the MAX4268/MAX4269/MAX4270 are available in a 16-pin QSOP package.

Applications

Base-Station Amplifiers
 IF Amplifiers
 High-Frequency ADC Drivers
 High-Speed DAC Buffers
 RF Telecom Applications
 High-Frequency Signal Processing

Features

- ◆ Operates from +4.5V to +8.0V
- ◆ Superior SFDR with 100Ω Load
 - 90dBc (f_c = 5MHz)
 - 59dBc (f_c = 100MHz)
- ◆ 35dBm IP3 (f_c = 20MHz)
- ◆ 8nV/√Hz Voltage Noise Density
- ◆ 100MHz 0.1dB Gain Flatness (MAX4268)
- ◆ 900V/μs Slew Rate
- ◆ ±45mA Output Driving Capability
- ◆ Disable Mode Places Outputs in High-Impedance State

Ordering Information

PART	TEMP. RANGE	PIN-PACKAGE
MAX4265 EUA	-40°C to +85°C	8 μMAX
MAX4265ESA	-40°C to +85°C	8 SO
MAX4266 EUA	-40°C to +85°C	8 μMAX
MAX4266ESA	-40°C to +85°C	8 SO
MAX4267 EUA	-40°C to +85°C	8 μMAX
MAX4267ESA	-40°C to +85°C	8 SO
MAX4268 EEE	-40°C to +85°C	16 QSOP
MAX4268ESD	-40°C to +85°C	14 SO
MAX4269 EEE	-40°C to +85°C	16 QSOP
MAX4269ESD	-40°C to +85°C	14 SO
MAX4270 EEE	-40°C to +85°C	16 QSOP
MAX4270ESD	-40°C to +85°C	14 SO

μMAX is a registered trademark of Maxim Integrated Products, Inc.

Pin Configurations appear at end of data sheet.

Selector Guide

PART	NO. OF OP AMPS	MIN GAIN (V/V)	-3dB BANDWIDTH (MHz)	GBP (MHz)	FULL-POWER BANDWIDTH (MHz)
MAX4265	1	1	400	400	270
MAX4266	1	2	350	700	350
MAX4267	1	5	300	1500	300
MAX4268	2	1	300	300	175
MAX4269	2	2	350	700	200
MAX4270	2	5	200	1000	200



Ultra-Low-Distortion, +5V, 400MHz Op Amps with Disable

ABSOLUTE MAXIMUM RATINGS

Supply Voltage (V _{CC} to V _{EE}).....	+8.5V
Voltage on Any Other Pin.....	(V _{EE} - 0.3V) to (V _{CC} + 0.3V)
Short-Circuit Duration (V _{OUT} to V _{CC} or V _{EE}).....	Continuous
Continuous Power Dissipation (T _A = +70°C)	
8-Pin μ MAX (derate 4.10mW/°C above +70°C).....	330mW
16-Pin QSOP (derate 8.33mW/°C above +70°C).....	667mW
8-Pin SO (derate 5.9mW/°C above +70°C).....	471mW
14-Pin SO (derate 8.33mW/°C above +70°C).....	667mW

Operating Temperature Range	-40°C to +85°C
Storage Temperature Range	-65°C to +150°C
Junction Temperature	+150°C
Lead Temperature (soldering, 10s)	+300°C

Stresses beyond those listed under "Absolute Maximum Ratings" may cause permanent damage to the device. These are stress ratings only, and functional operation of the device at these or any other conditions beyond those indicated in the operational sections of the specifications is not implied. Exposure to absolute maximum rating conditions for extended periods may affect device reliability.

DC ELECTRICAL CHARACTERISTICS

(V_{CC} = +5V, V_{EE} = 0, R_L = 100 Ω to V_{CC}/2, V_{CM} = V_{CC}/2, T_A = T_{MIN} to T_{MAX}, unless otherwise noted. Typical values are at T_A = +25°C.)

PARAMETER	SYMBOL	CONDITIONS	MIN	TYP	MAX	UNITS
Operating Supply Voltage Range	V _{CC}	Inferred from PSRR test	4.5		8.0	V
Common-Mode Input Voltage	V _{CM}	Inferred from CMRR test	V _{EE} + 1.6		V _{CC} - 1.6	V
Input Offset Voltage	V _{OS}			1	9	mV
Input Offset Voltage Drift	TCV _{OS}			1.5		μ V/°C
Input Offset Voltage Channel Matching		MAX4268/MAX4269/MAX4270		1		mV
Input Bias Current	I _B			3.5	40	μ A
Input Offset Current	I _{OS}			0.1	6	μ A
Common-Mode Input Resistance	R _{INCM}	Either input (V _{EE} + 1.6V) \leq V _{CM} \leq (V _{CC} - 1.6V)		1		M Ω
Differential Input Resistance	R _{INDIFF}	-10mV \leq V _{IN} \leq 10mV		40		k Ω
Common-Mode Rejection Ratio	CMRR	(V _{EE} + 1.6V) \leq V _{CM} \leq (V _{CC} - 1.6V), no load	60	85		dB
Power-Supply Rejection Ratio	PSRR	V _{CC} = 4.5V to 8.0V	60	85		dB
Open-Loop Voltage Gain	A _{OL}	1.75V \leq V _{OUT} \leq 3.25V	60	95		dB
Output Voltage Swing	V _{OUT}	V _{CC} - V _{OH} , V _{OL} - V _{EE}		1.1	1.5	V
Output Current Drive	I _{OUT}	R _L = 20 Ω	\pm 30	\pm 45		mA
Output Short-Circuit Current	I _{SC}	Sinking or sourcing to V _{CC} or V _{EE}		100		mA
Closed-Loop Output Resistance	R _{OUT}			0.035		Ω
Power-Up Time	t _{PWRUP}	V _{OUT} = 1V step, 0.1% settling time		10		μ s
Quiescent Supply Current (per amplifier)	I _S	Normal mode, $\overline{\text{DISABLE}} = \text{V}_{\text{CC}}$ or floating		28	32	mA
		Disable mode, $\overline{\text{DISABLE}} = \text{V}_{\text{EE}}$		1.6	5	
Disable Output Leakage Current		$\overline{\text{DISABLE}} = \text{V}_{\text{EE}}$, V _{EE} \leq V _{OUT} \leq V _{CC}		0.2	2.5	μ A
$\overline{\text{DISABLE}}$ Logic Low					V _{CC} - 3.5	V
$\overline{\text{DISABLE}}$ Logic High			V _{CC} - 1.5			V
$\overline{\text{DISABLE}}$ Logic Input Low Current		$\overline{\text{DISABLE}} = \text{V}_{\text{EE}}$		5	100	μ A
$\overline{\text{DISABLE}}$ Logic Input High Current		$\overline{\text{DISABLE}} = \text{V}_{\text{CC}}$		1	30	μ A

Ultra-Low-Distortion, +5V, 400MHz Op Amps with Disable

MAX4265-MAX4270

AC ELECTRICAL CHARACTERISTICS

($V_{CC} = +5V$, $V_{EE} = 0$, $R_L = 100\Omega$ to $V_{CC}/2$, $V_{CM} = V_{CC}/2$, MAX4265/MAX4268 $A_V = +1V/V$, MAX4266/MAX4269 $A_V = +2V/V$, MAX4267/MAX4270 $A_V = +5V/V$, $T_A = T_{MIN}$ to T_{MAX} , unless otherwise noted. Typical values are at $T_A = +25^\circ C$.)

PARAMETER	SYMBOL	CONDITIONS	MIN	TYP	MAX	UNITS
Small-Signal -3dB Bandwidth	BW-3dB	$V_{OUT} = 100mVp-p$	MAX4265	400		MHz
			MAX4266	350		
			MAX4267	300		
			MAX4268	300		
			MAX4269	350		
			MAX4270	200		
Full-Power Bandwidth	FPBW	$V_{OUT} = 1Vp-p$	MAX4265	270		MHz
			MAX4266	350		
			MAX4267	300		
			MAX4268	175		
			MAX4269	200		
			MAX4270	200		
0.1dB Gain Flatness	BW0.1dB	$V_{OUT} = 100mVp-p$	MAX4265	80		MHz
			MAX4266	30		
			MAX4267	55		
			MAX4268	100		
			MAX4269	35		
			MAX4270	35		
All-Hostile Crosstalk		$f = 10MHz$		85		dB
Slew Rate	SR	$V_{OUT} = +1V$ step		900		V/ μs
Rise/Fall Times	t_R, t_F	$V_{OUT} = +1V$ step		1		ns
Settling Time (0.1%)	$t_{S,0.1}$	$V_{OUT} = +1V$ step		15		ns
Spurious-Free Dynamic Range	SFDR	$V_{OUT} = 1Vp-p$ (MAX4265/ MAX4266/ MAX4267)	$f_C = 1MHz$	83		dBc
			$f_C = 5MHz$	85		
			$f_C = 10MHz$	87		
			$f_C = 20MHz$	81		
			$f_C = 60MHz$	50		
			$f_C = 100MHz$	47		
		$V_{OUT} = 1Vp-p$ (MAX4268)	$f_C = 1MHz$	85		
			$f_C = 5MHz$	85		
			$f_C = 10MHz$	84		
			$f_C = 20MHz$	79		
			$f_C = 60MHz$	68		
			$f_C = 100MHz$	60		

Ultra-Low-Distortion, +5V, 400MHz Op Amps with Disable

AC ELECTRICAL CHARACTERISTICS (continued)

($V_{CC} = +5V$, $V_{EE} = 0$, $R_L = 100\Omega$ to $V_{CC}/2$, $V_{CM} = V_{CC}/2$, MAX4265/MAX4268 $A_V = +1V/V$, MAX4266/MAX4269 $A_V = +2V/V$, MAX4267/MAX4270 $A_V = +5V/V$, $T_A = T_{MIN}$ to T_{MAX} , unless otherwise noted. Typical values are at $T_A = +25^\circ C$.)

PARAMETER	SYMBOL	CONDITIONS	MIN	TYP	MAX	UNITS			
Spurious-Free Dynamic Range	SFDR	$V_{OUT} = 1V_{p-p}$ (MAX4269)	$f_C = 1MHz$		88	dBc			
			$f_C = 5MHz$		90				
			$f_C = 10MHz$		88				
			$f_C = 20MHz$		79				
			$f_C = 60MHz$		68				
			$f_C = 100MHz$		59				
		$V_{OUT} = 1V_{p-p}$ (MAX4270)	$f_C = 1MHz$		86				
			$f_C = 5MHz$		81				
			$f_C = 10MHz$		75				
			$f_C = 20MHz$		68				
			$f_C = 60MHz$		60				
			$f_C = 100MHz$		56				
		Second Harmonic Distortion		$V_{OUT} = 1V_{p-p}$ (MAX4265/ MAX4266/ MAX4267)	$f_C = 1MHz$			83	dBc
					$f_C = 5MHz$			85	
$f_C = 10MHz$					87				
$f_C = 20MHz$					81				
$f_C = 60MHz$					50				
$f_C = 100MHz$					47				
$V_{OUT} = 1V_{p-p}$ (MAX4268)	$f_C = 1MHz$				85				
	$f_C = 5MHz$				85				
	$f_C = 10MHz$				84				
	$f_C = 20MHz$				79				
	$f_C = 60MHz$				68				
	$f_C = 100MHz$				60				
$V_{OUT} = 1V_{p-p}$ (MAX4269)	$f_C = 1MHz$				88				
	$f_C = 5MHz$				90				
	$f_C = 10MHz$				88				
	$f_C = 20MHz$				79				
	$f_C = 60MHz$				68				
	$f_C = 100MHz$				59				
$V_{OUT} = 1V_{p-p}$ (MAX4270)	$f_C = 1MHz$				86				
	$f_C = 5MHz$				81				
	$f_C = 10MHz$				75				
	$f_C = 20MHz$				68				
	$f_C = 60MHz$				60				
	$f_C = 100MHz$				56				

Ultra-Low-Distortion, +5V, 400MHz Op Amps with Disable

MAX4265-MAX4270

AC ELECTRICAL CHARACTERISTICS (continued)

($V_{CC} = +5V$, $V_{EE} = 0$, $R_L = 100\Omega$ to $V_{CC}/2$, $V_{CM} = V_{CC}/2$, MAX4265/MAX4268 $A_V = +1V/V$, MAX4266/MAX4269 $A_V = +2V/V$, MAX4267/MAX4270 $A_V = +5V/V$, $T_A = T_{MIN}$ to T_{MAX} , unless otherwise noted. Typical values are at $T_A = +25^\circ C$.)

PARAMETER	SYMBOL	CONDITIONS	MIN	TYP	MAX	UNITS
Third Harmonic Distortion		$V_{OUT} = 1V_{p-p}$ (MAX4265/ MAX4266/ MAX4267)	$f_C = 1MHz$		98	dBc
			$f_C = 5MHz$		96	
			$f_C = 10MHz$		91	
			$f_C = 20MHz$		85	
			$f_C = 60MHz$		75	
			$f_C = 100MHz$		61	
		$V_{OUT} = 1V_{p-p}$ (MAX4268)	$f_C = 1MHz$		95	
			$f_C = 5MHz$		95	
			$f_C = 10MHz$		93	
			$f_C = 20MHz$		86	
			$f_C = 60MHz$		72	
			$f_C = 100MHz$		64	
		$V_{OUT} = 1V_{p-p}$ (MAX4269)	$f_C = 1MHz$		88	
			$f_C = 5MHz$		90	
			$f_C = 10MHz$		88	
			$f_C = 20MHz$		79	
			$f_C = 60MHz$		68	
			$f_C = 100MHz$		59	
		$V_{OUT} = 1V_{p-p}$ (MAX4270)	$f_C = 1MHz$		96	
			$f_C = 5MHz$		97	
			$f_C = 10MHz$		91	
			$f_C = 20MHz$		84	
			$f_C = 60MHz$		74	
			$f_C = 100MHz$		69	
Two-Tone, Third-Order Intercept Distortion	IP3	$V_{OUT} = 1V_{p-p}$, $f_{CA} = 20MHz$, $f_{CB} = 21.25MHz$	MAX4265/MAX4268		32	dBm
			MAX4266/MAX4269		35	
			MAX4267/MAX4270		35	

Ultra-Low-Distortion, +5V, 400MHz Op Amps with Disable

AC ELECTRICAL CHARACTERISTICS (continued)

($V_{CC} = +5V$, $V_{EE} = 0$, $R_L = 100\Omega$ to $V_{CC}/2$, $V_{CM} = V_{CC}/2$, MAX4265/MAX4268 $A_V = +1V/V$, MAX4266/MAX4269 $A_V = +2V/V$, MAX4267/MAX4270 $A_V = +5V/V$, $T_A = T_{MIN}$ to T_{MAX} , unless otherwise noted. Typical values are at $T_A = +25^\circ C$.)

PARAMETER	SYMBOL	CONDITIONS	MIN	TYP	MAX	UNITS
Input -1dB Compression Point		$f_C = 20MHz$		12		dBm
Differential Gain	D_G	NTSC, $f = 3.58MHz$, $R_L = 150\Omega$ to $V_{CC}/2$		0.015		%
Differential Phase	D_P	NTSC, $f = 3.58MHz$, $R_L = 150\Omega$ to $V_{CC}/2$		0.03		degrees
Input Capacitance	C_{IN}			2		pF
Output Impedance	R_{OUT}	$f = 10MHz$		1		Ω
Disabled Output Capacitance		$\overline{DISABLE}_- = V_{EE}$		5		pF
Enable Time	t_{EN}	$V_{IN} = +1V$		100		ns
Disable Time	t_{DIS}	$V_{IN} = +1V$		750		μs
Capacitive Load Stability		No sustained oscillation	MAX4265/MAX4268	15		pF
			MAX4266/MAX4269	15		
			MAX4267/MAX4270	22		
Input Voltage Noise Density	e_n	$f = 1kHz$		8		nV/\sqrt{Hz}
Input Current Noise Density	i_n	$f = 1kHz$		1		pA/\sqrt{Hz}

Typical Operating Characteristics

($V_{CC} = +5V$, $V_{EE} = 0$, $\overline{DISABLE}_- = +5V$, $R_L = 100\Omega$ to $V_{CC}/2$, MAX4265/MAX4268 $A_V = +1V/V$, MAX4266/MAX4269 $A_V = +2V/V$, MAX4267/MAX4270 $A_V = +5V/V$, $T_A = +25^\circ C$, unless otherwise noted.)

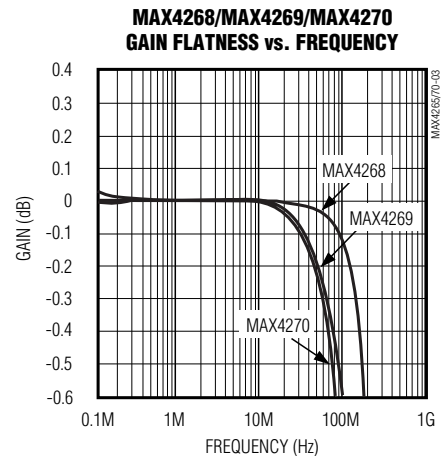
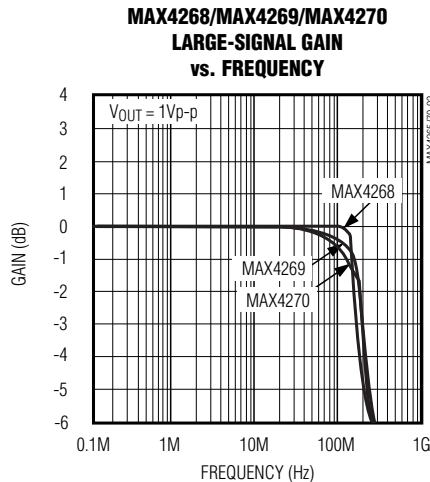
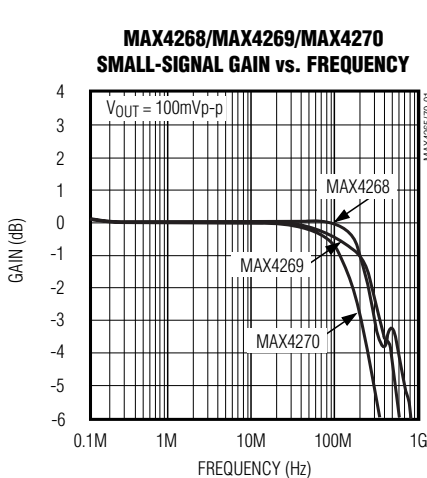

Ultra-Low-Distortion, +5V, 400MHz Op Amps with Disable

MAX4265-MAX4270

Typical Operating Characteristics (continued)

($V_{CC} = +5V$, $V_{EE} = 0$, $\overline{DISABLE} = +5V$, $R_L = 100\Omega$ to $V_{CC}/2$, MAX4265/MAX4268 $A_V = +1V/V$, MAX4266/MAX4269 $A_V = +2V/V$, MAX4267/MAX4270 $A_V = +5V/V$, $T_A = +25^\circ C$, unless otherwise noted.)

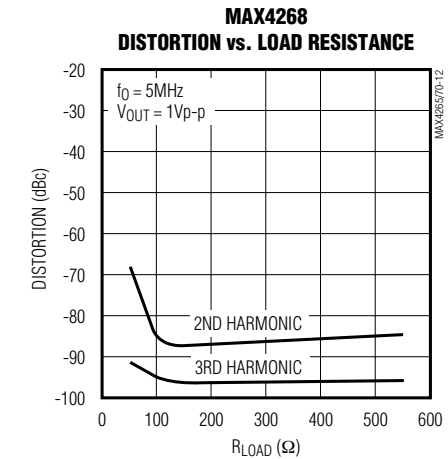
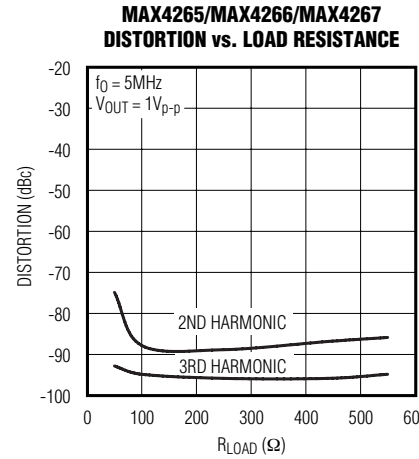
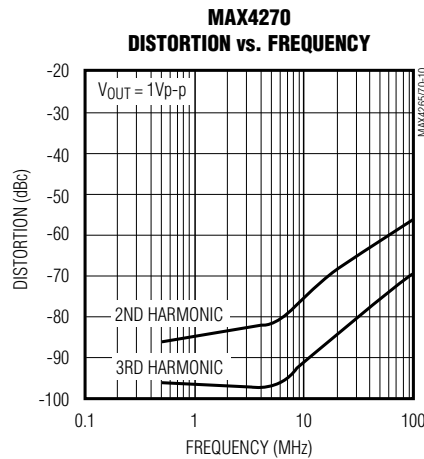
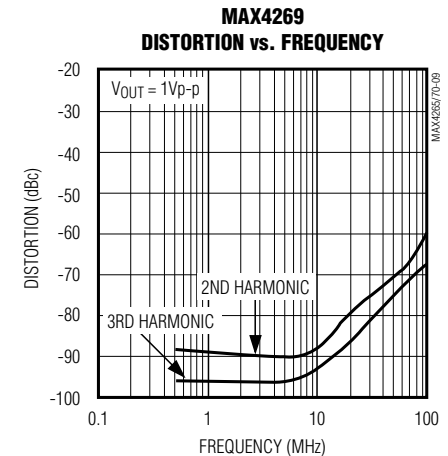
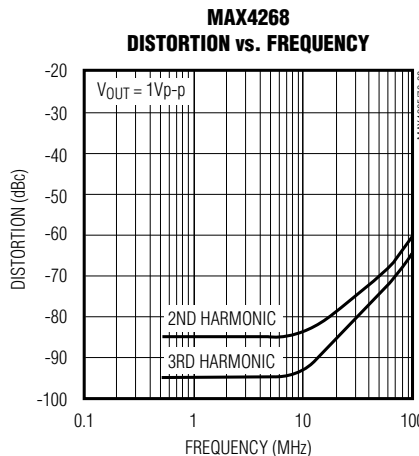
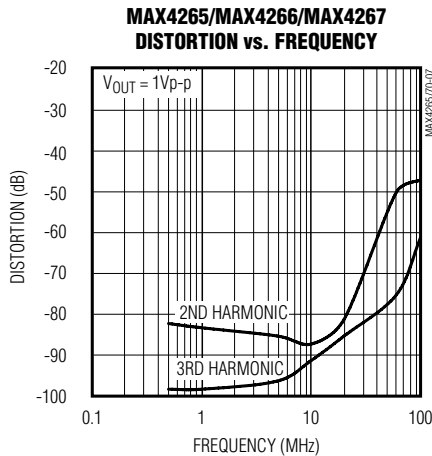
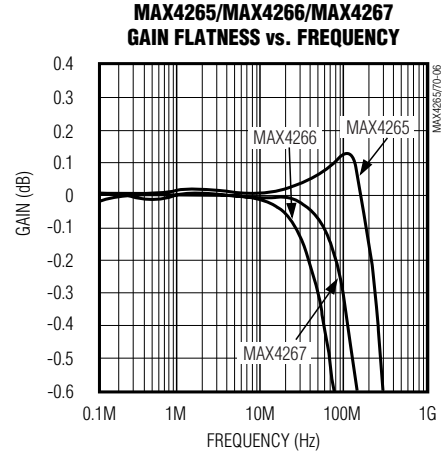
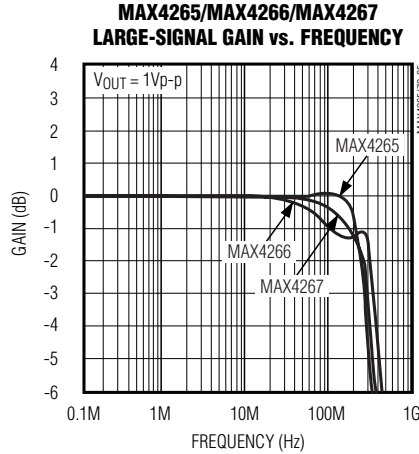
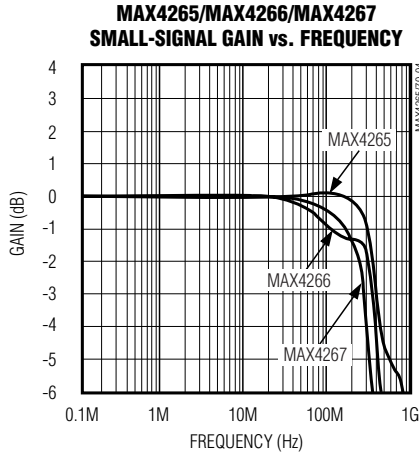

Ultra-Low-Distortion, +5V, 400MHz Op Amps with Disable

Typical Operating Characteristics (continued)

($V_{CC} = +5V$, $V_{EE} = 0$, $\overline{DISABLE}_- = +5V$, $R_L = 100\Omega$ to $V_{CC}/2$, MAX4265/MAX4268 $A_V = +1V/V$, MAX4266/MAX4269 $A_V = +2V/V$, MAX4267/MAX4270 $A_V = +5V/V$, $T_A = +25^\circ C$, unless otherwise noted.)

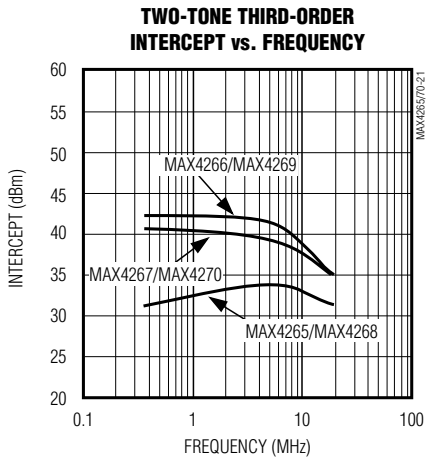
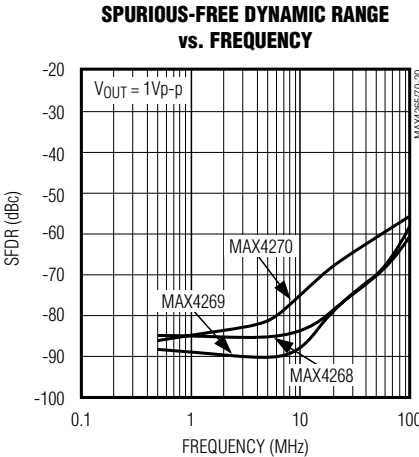
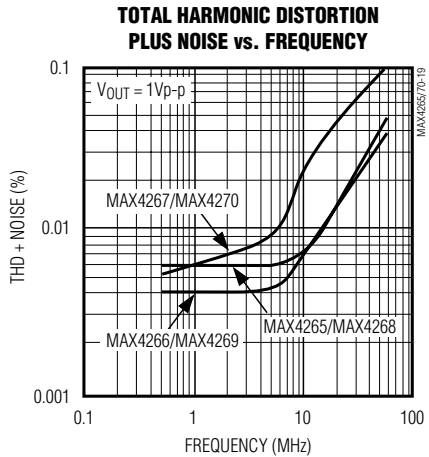
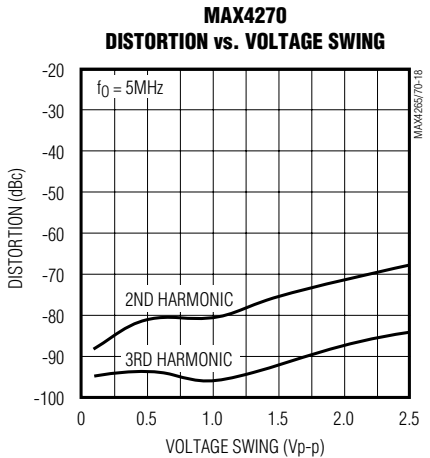
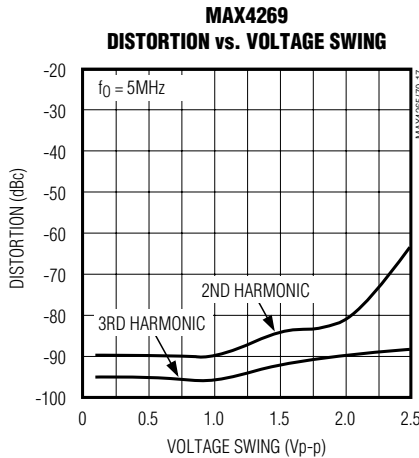
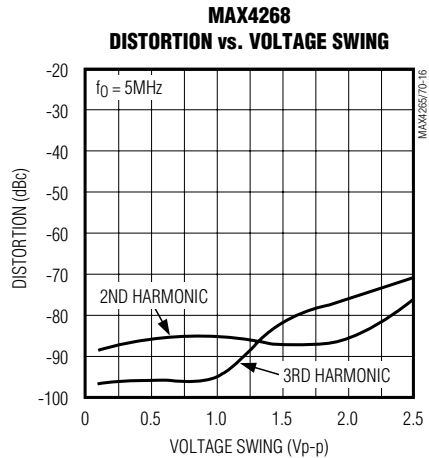
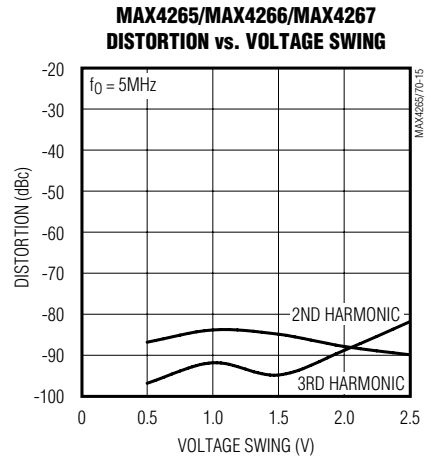
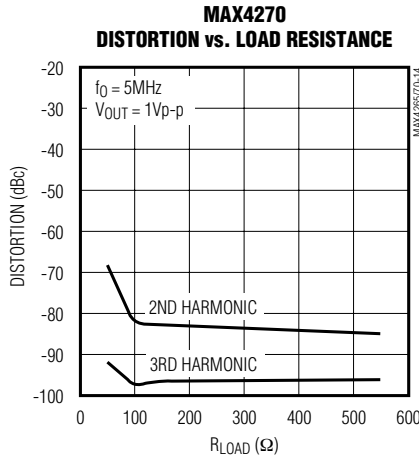
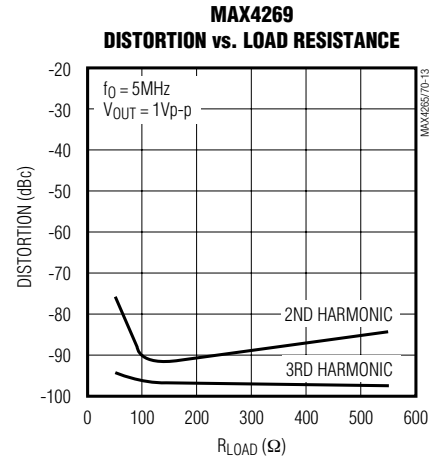

Ultra-Low-Distortion, +5V, 400MHz Op Amps with Disable

MAX4265-MAX4270

Typical Operating Characteristics (continued)

($V_{CC} = +5V$, $V_{EE} = 0$, $\overline{DISABLE} = +5V$, $R_L = 100\Omega$ to $V_{CC}/2$, MAX4265/MAX4268 $A_V = +1V/V$, MAX4266/MAX4269 $A_V = +2V/V$, MAX4267/MAX4270 $A_V = +5V/V$, $T_A = +25^\circ C$, unless otherwise noted.)

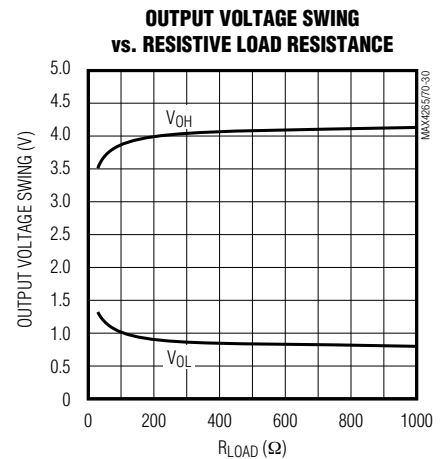
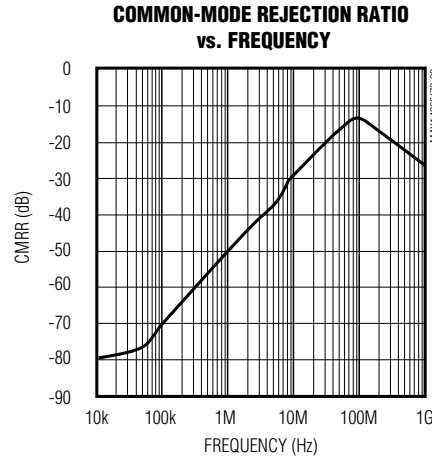
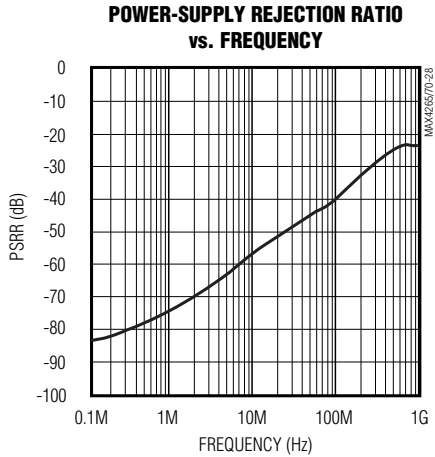
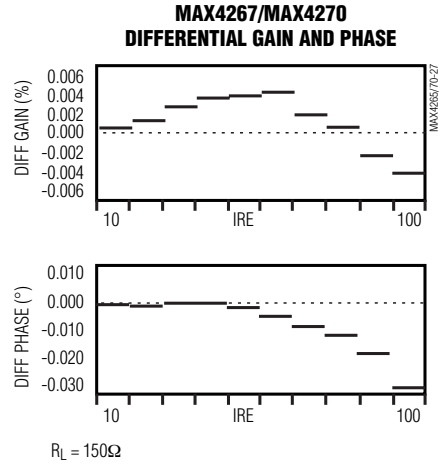
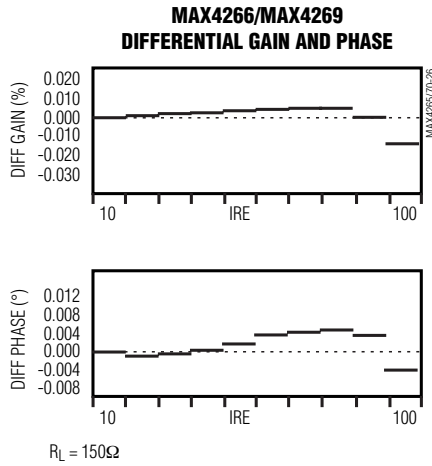
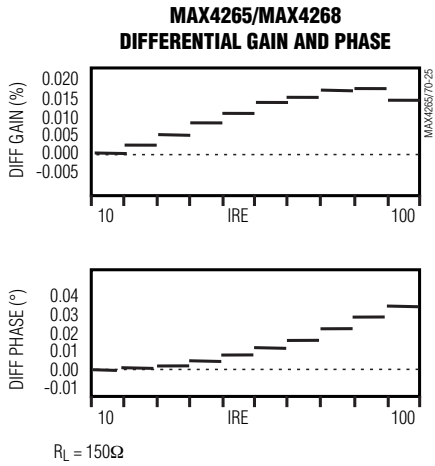
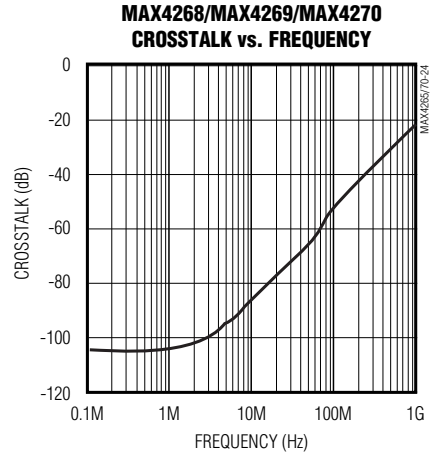
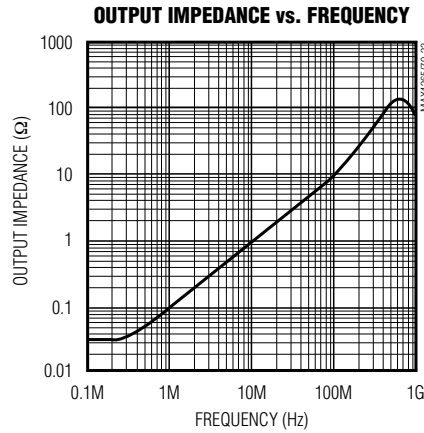
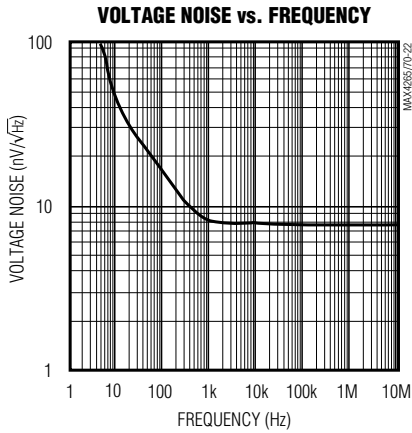

Ultra-Low-Distortion, +5V, 400MHz Op Amps with Disable

Typical Operating Characteristics (continued)

($V_{CC} = +5V$, $V_{EE} = 0$, $\overline{DISABLE} = +5V$, $R_L = 100\Omega$ to $V_{CC}/2$, MAX4265/MAX4268 $A_V = +1V/V$, MAX4266/MAX4269 $A_V = +2V/V$, MAX4267/MAX4270 $A_V = +5V/V$, $T_A = +25^\circ C$, unless otherwise noted.)

POWER-UP/POWER-DOWN RESPONSE

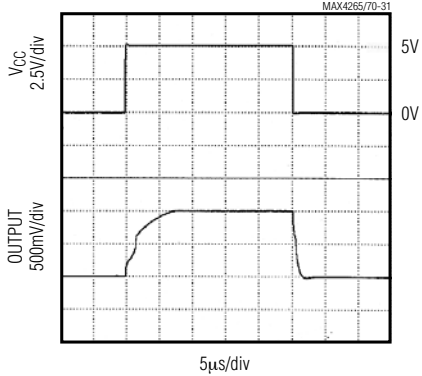

DISABLE/ENABLE RESPONSE

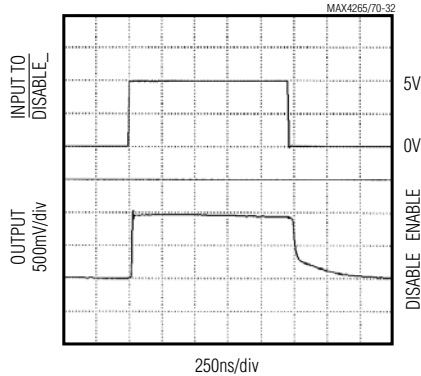

INPUT OFFSET VOLTAGE vs. SUPPLY VOLTAGE

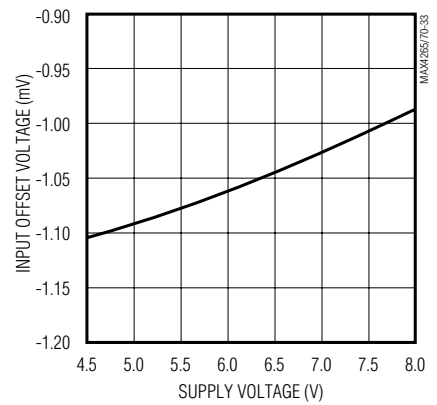

INPUT BIAS CURRENT vs. SUPPLY VOLTAGE

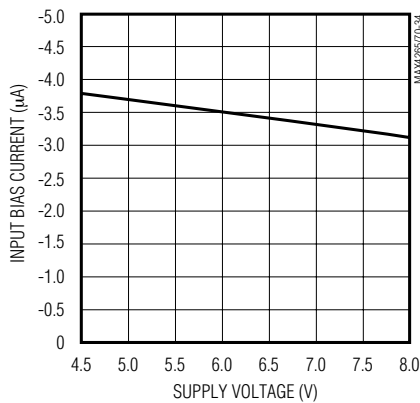

SUPPLY CURRENT (PER AMPLIFIER) vs. SUPPLY VOLTAGE

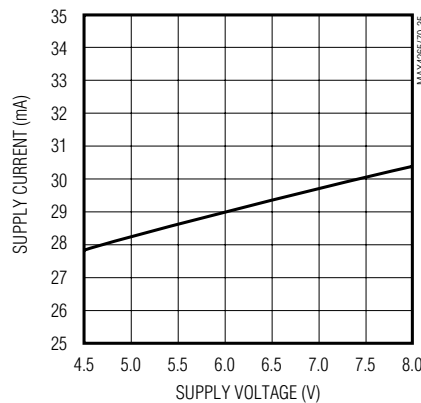

INPUT OFFSET VOLTAGE vs. TEMPERATURE

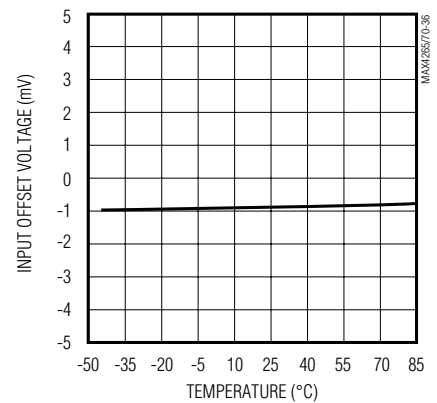

INPUT BIAS CURRENT vs. TEMPERATURE

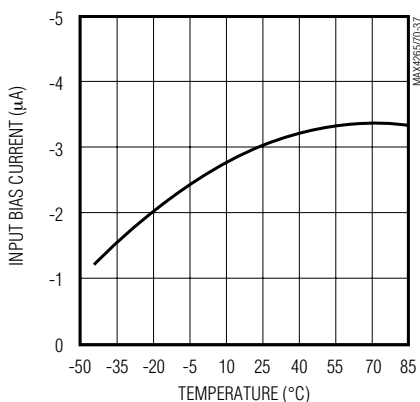

INPUT OFFSET CURRENT vs. TEMPERATURE

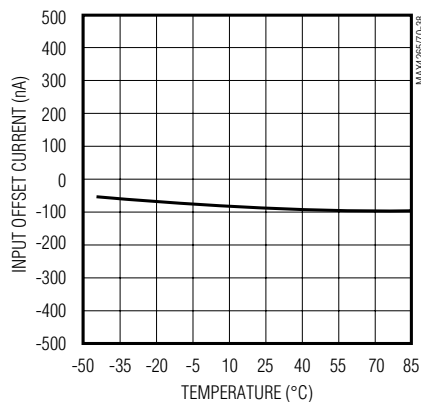

SUPPLY CURRENT (PER AMPLIFIER) vs. TEMPERATURE

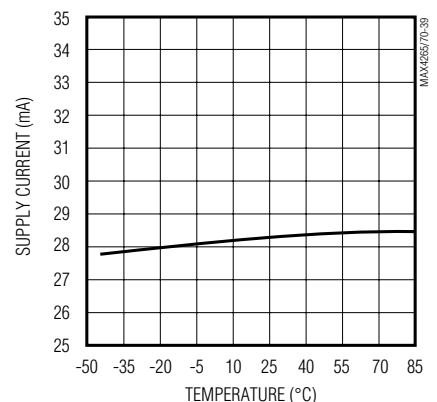

Ultra-Low-Distortion, +5V, 400MHz Op Amps with Disable

MAX4265-MAX4270

Typical Operating Characteristics (continued)

($V_{CC} = +5V$, $V_{EE} = 0$, $\overline{DISABLE}_- = +5V$, $R_L = 100\Omega$ to $V_{CC}/2$, MAX4265/MAX4268 $A_V = +1V/V$, MAX4266/MAX4269 $A_V = +2V/V$, MAX4267/MAX4270 $A_V = +5V/V$, $T_A = +25^\circ C$, unless otherwise noted.)

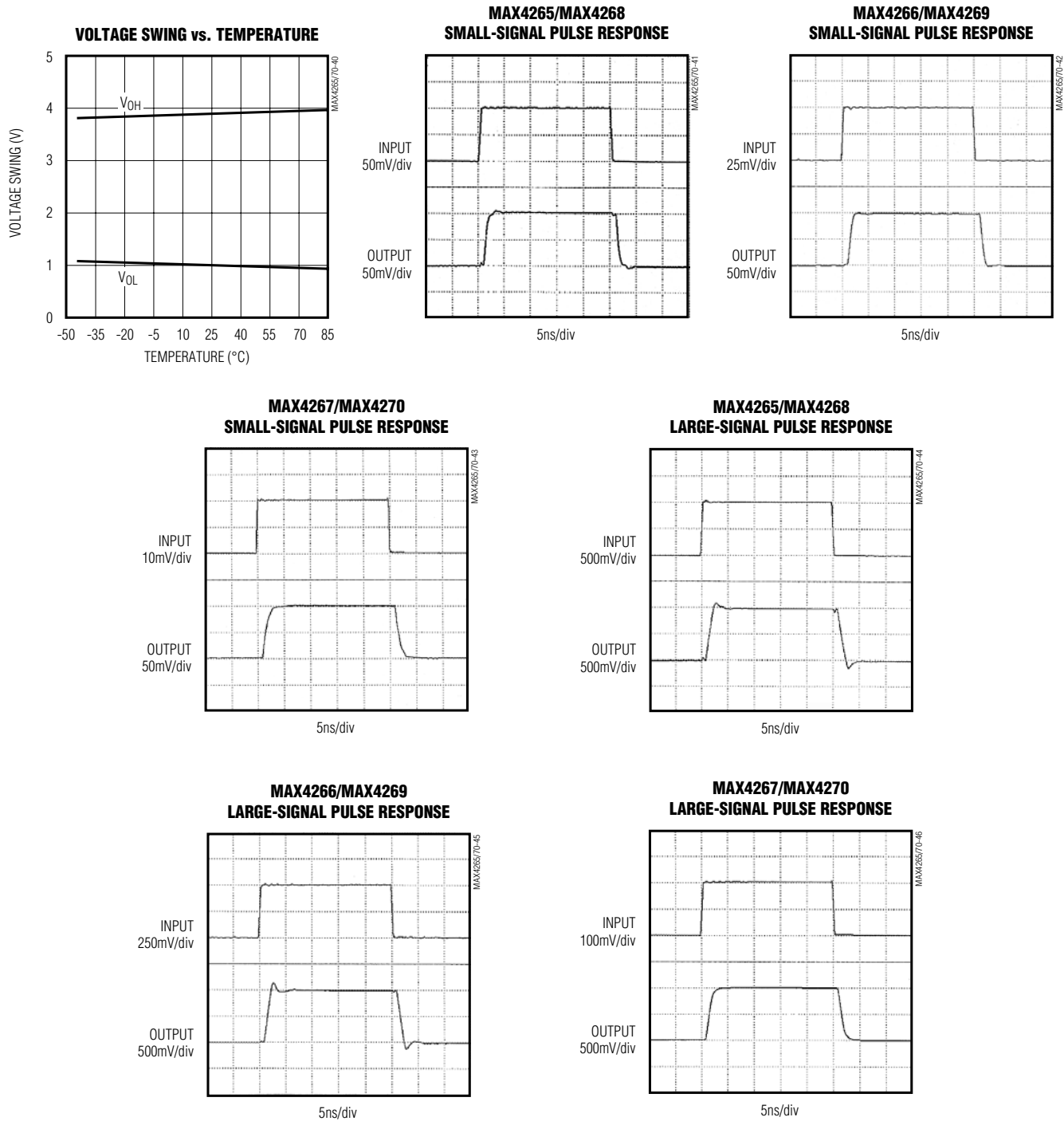

Ultra-Low-Distortion, +5V, 400MHz Op Amps with Disable

Pin Description

PIN			NAME	FUNCTION
MAX4265 MAX4266 MAX4267	MAX4268 MAX4269 MAX4270			
8 μ MAX/SO	14 SO	16 QSOP		
1	—	—	$\overline{\text{DISABLE}}$	Disable Input. Active low.
—	4, 5	4, 5	$\overline{\text{DISABLEA}}, \overline{\text{DISABLEB}}$	Disable Input. Active low.
2	—	—	IN-	Inverting Input
—	2, 9	2, 11	INA-, INB-	Inverting Input
3	—	—	IN+	Noninverting Input
—	3, 10	3, 12	INA+, INB+	Noninverting Input
4, 5	6, 7	6, 7	V _{EE}	Negative Power Supply
6	—	—	OUT	Amplifier Output
—	1, 8	1, 10	OUTA, OUTB	Amplifier Output
7, 8	13, 14	15, 16	V _{CC}	Positive Power Supply. Connect to a +4.5V to +8.0V supply.
—	11, 12	8, 9, 13, 14	N.C.	No Connection. Not internally connected.

Detailed Description

The MAX4265–MAX4270 family of operational amplifiers features ultra-low distortion and wide bandwidth. Their low distortion and low noise make them ideal for driving high-speed ADCs up to 16 bits in telecommunication applications and high-performance signal processing.

These devices can drive a 100 Ω load and deliver 45mA while maintaining DC accuracy and AC performance. The input common-mode voltage ranges from (V_{EE} + 1.6V) to (V_{CC} - 1.6V), while the output typically swings to within 1.1V of the rails.

Low Distortion

The MAX4265–MAX4270 use proprietary bipolar technology to achieve minimum distortion in low-voltage systems. This feature is typically available only in dual-supply op amps.

Several factors can affect the noise and distortion that a device contributes to the input signal. The following guidelines explain how various design choices impact the total harmonic distortion (THD):

- Choose the proper feedback-resistor and gain-resistor values for the application. In general, the smaller the closed-loop gain, the smaller the THD generated, especially when driving heavy resistive loads. Large-value feedback resistors can significantly improve distortion. The MAX4265–MAX4270's THD normally increases at approximately 20dB per decade at frequencies above 1MHz; this is a lower rate than that of comparable dual-supply op amps.
- Operating the device near or above the full-power bandwidth significantly degrades distortion (see the Total Harmonic Distortion vs. Frequency graph in the *Typical Operating Characteristics*).
- The decompensated devices (MAX4266/MAX4267/MAX4269/MAX4270) deliver the best distortion performance since they have a slightly higher slew rate and provide a higher amount of loop gain for a given closed-loop gain setting.

Ultra-Low-Distortion, +5V, 400MHz Op Amps with Disable

MAX4265-MAX4270

Choosing Resistor Values

Unity-Gain Configurations

The MAX4265 and MAX4268 are internally compensated for unity gain. When configured for unity gain, they require a small resistor (R_F) in series with the feedback path (Figure 1). This resistor improves AC response by reducing the Q of the tank circuit, which is formed by parasitic feedback inductance and capacitance.

Inverting and Noninverting Configurations

The values of the gain-setting feedback and input resistors are important design considerations. Large resistor values will increase voltage noise and interact with the amplifier's input and PC board capacitance to generate undesirable poles and zeros, which can decrease bandwidth or cause oscillations. For example, a noninverting gain of +2V/V (Figure 1) using $R_F = R_G = 1k\Omega$ combined with 2pF of input capacitance and 0.5pF of board capacitance will cause a feedback pole at 128MHz. If this pole is within the anticipated amplifier bandwidth, it will jeopardize stability. Reducing the 1k Ω resistors to 100 Ω extends the pole frequency to 1.28GHz, but could limit output swing by adding 200 Ω in parallel with the amplifier's load. Clearly, the selection of resistor values must be tailored to the specific application.

Distortion Considerations

The MAX4265-MAX4270 are ultra-low-distortion, high-bandwidth op amps. Output distortion will degrade as the total load resistance seen by the amplifier decreases. To minimize distortion, keep the input and gain-setting resistor values relatively large. A 500 Ω feedback resistor combined with an appropriate input resistor to set the gain will provide excellent AC performance without significantly increasing distortion.

Noise Considerations

The amplifier's input-referred noise-voltage density is dominated by flicker noise at lower frequencies and by thermal noise at higher frequencies. Because the thermal noise contribution is affected by the parallel combination of the feedback resistive network, those resistor values should be reduced in cases where the system bandwidth is large and thermal noise is dominant. This noise-contribution factor decreases, however, with increasing gain settings. For example, the input noise voltage density at the op amp input with a gain of +10V/V using $R_F = 100k\Omega$ and $R_G = 11k\Omega$ is $e_n = 18nV/\sqrt{Hz}$. The input noise can be reduced to 8nV/ \sqrt{Hz} by choosing $R_F = 1k\Omega$, $R_G = 110\Omega$.

Driving Capacitive Loads

The MAX4265-MAX4270 are not designed to drive highly reactive loads. Stability is maintained with loads up to 15pF with less than 2dB peaking in the frequency response. To drive higher capacitive loads, place a small isolation resistor in series between the amplifier's output and the capacitive load (Figure 1). This resistor improves the amplifier's phase margin by isolating the capacitor from the op amp's output.

To ensure a load capacitance that limits peaking to less than 2dB, select a resistance value from Figure 2. For example, if the capacitive load is 100pF, the corresponding isolation resistor is 6 Ω (MAX4266/MAX4269). Figures 3 and 4 show the peaking that occurs in the frequency response with and without an isolation resistor.

Coaxial cable and other transmission lines are easily driven when terminated at both ends with their characteristic impedance. When driving back-terminated transmission lines, the capacitive load of the transmission line is essentially eliminated.

ADC Input Buffer

Input buffer amplifiers can be a source of significant errors in high-speed ADC applications. The input buffer is usually required to rapidly charge and discharge the ADC's input, which is often capacitive (see *Driving Capacitive Loads*). In addition, since a high-speed ADC's input impedance often changes very rapidly during the conversion cycle, measurement accuracy must

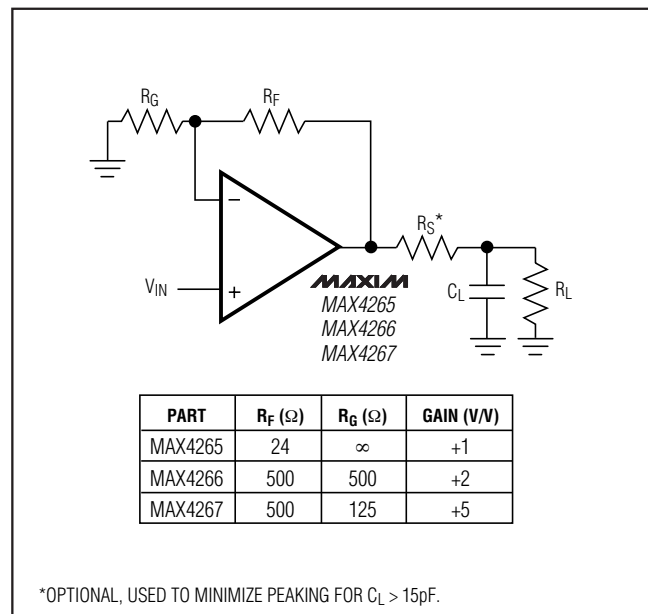

Figure 1. Noninverting Configuration

Ultra-Low-Distortion, +5V, 400MHz Op Amps with Disable

be maintained using an amplifier with very low output impedance at high frequencies. The combination of high speed, fast slew rate, low noise, and a low and stable distortion overload makes the MAX4265-MAX4270 ideally suited for use as buffer amplifiers in high-speed ADC applications.

Low-Power Disable Mode

The MAX4265-MAX4270 feature an active-low disable mode that can be used to save power and place the outputs in a high-impedance state. Drive `DISABLE_` with logic levels, or connect `DISABLE_` to `VCC` for normal operation. In the dual versions (MAX4268/ MAX4269/ MAX4270), each individual op amp is disabled separately, allowing the devices to be used in a multiplex configuration. The supply current in low-power mode is reduced to 1.6mA per amplifier. Enable time is typically 100ns, and disable time is typically 750µs.

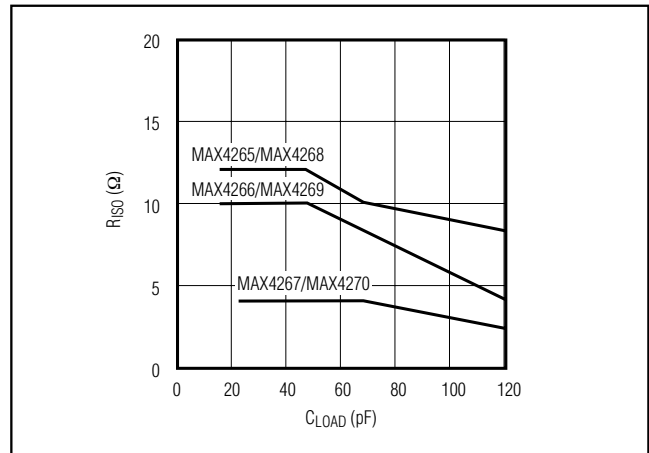

Figure 2. MAX4265-MAX4270 Isolation Resistance vs. Capacitive Load

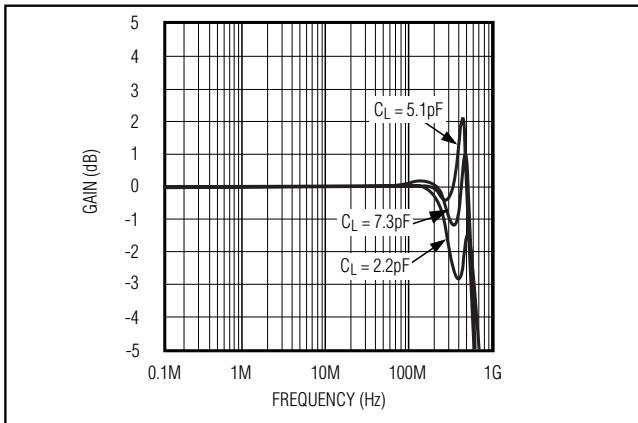

Figure 3a. MAX4268 Small-Signal Gain vs. Frequency Without Isolation Resistor

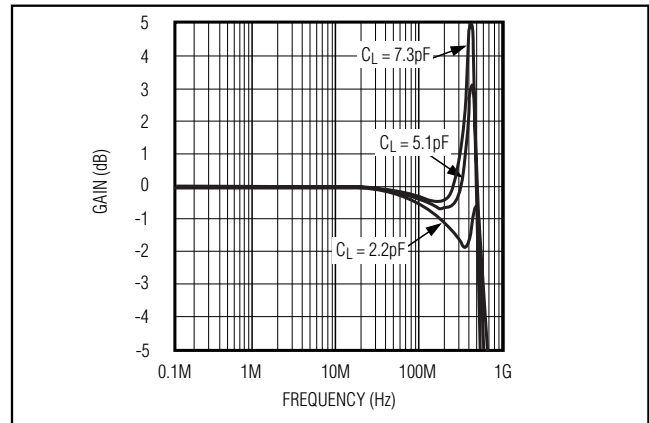

Figure 3b. MAX4269 Small-Signal Gain vs. Frequency Without Isolation Resistor

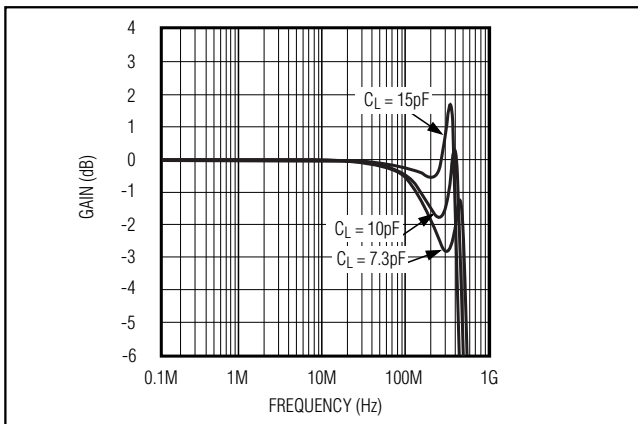

Figure 3c. MAX4270 Small-Signal Gain vs. Frequency Without Isolation Resistor

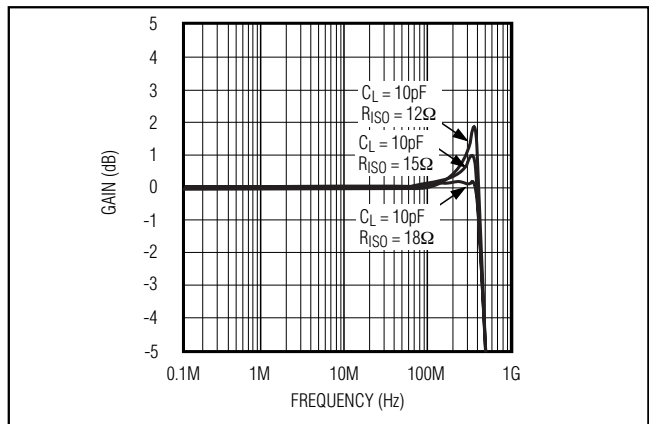

Figure 4a. MAX4268 Small-Signal Gain vs. Frequency With Isolation Resistor

Ultra-Low-Distortion, +5V, 400MHz Op Amps with Disable

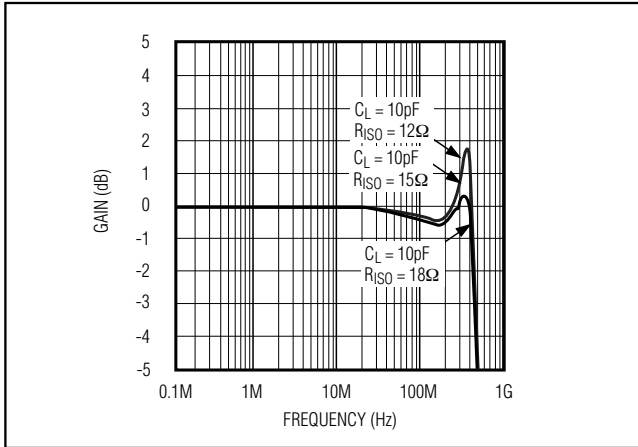

Figure 4b. MAX4269 Small-Signal Gain vs. Frequency With Isolation Resistor

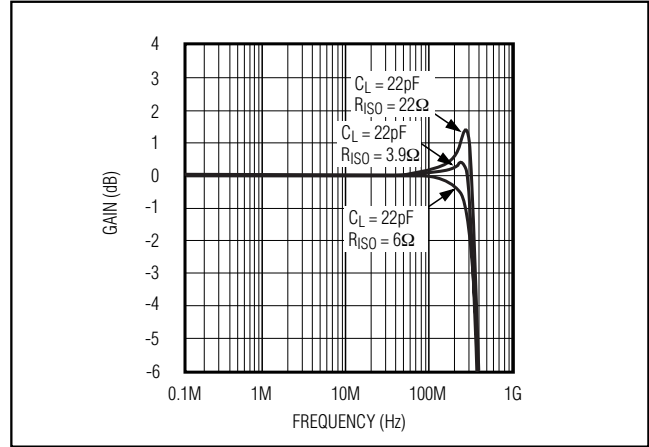

Figure 4c. MAX4270 Small-Signal Gain vs. Frequency With Isolation Resistor

Power Supplies, Bypassing, and Layout

The MAX4265–MAX4270 operate from a single +4.5V to +8.0V supply or in a dual-supply configuration.

When operating with a single supply, connect the VEE pins directly to the ground plane. Bypass VCC to ground with ceramic chip capacitors. Due to the MAX4265–MAX4270s' wide bandwidth, use a 1nF capacitor in parallel with a 0.1μF to 1μF capacitor. If the device is located more than 10cm from the power supply, adding a larger bulk capacitor will improve performance.

When operating with dual supplies, ensure that the total voltage across the device (VCC to VEE) does not exceed +8V. Therefore, supplies of ±2.5V, ±3.3V, and asymmetrical supplies are possible. For example, operation with VCC = +5V and VEE = -3V provides sufficient voltage swing for the negative pulses found in video signals. When operating with dual supplies, the VCC pins and the VEE pins should be bypassed using the same guidelines stated in the paragraph above.

Because the MAX4265–MAX4270 have high bandwidth, circuit layout becomes critical. A solid ground plane provides a low-inductance path for high-speed transient currents. Use multiple vias to the ground plane for each bypass capacitor. If VEE is connected to ground, use multiple vias here, too. Avoid sharing ground vias with other signals to reduce crosstalk between circuit sections.

Avoid stray capacitance at the op amp's inverting inputs. Stray capacitance, in conjunction with the feedback resistance, forms an additional pole in the circuit's transfer function, with its associate phase shift. Minimizing the trace lengths connected to the inverting input helps minimize stray capacitance.

Chip Information

MAX4265/66/67 TRANSISTOR COUNT: 132

MAX4268/69/70 TRANSISTOR COUNT: 285

PROCESS: Bipolar

Ultra-Low-Distortion, +5V, 400MHz Op Amps with Disable

Pin Configurations

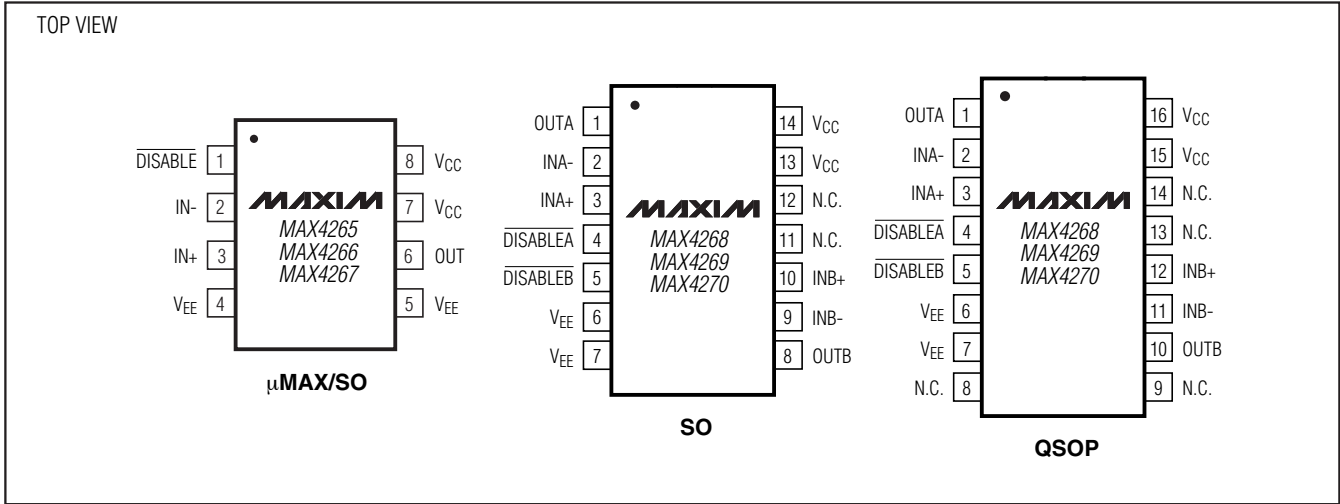

Ultra-Low-Distortion, +5V, 400MHz Op Amps with Disable

Package Information

(The package drawing(s) in this data sheet may not reflect the most current specifications. For the latest package outline information go to www.maxim-ic.com/packages.)

MAX4265-MAX4270

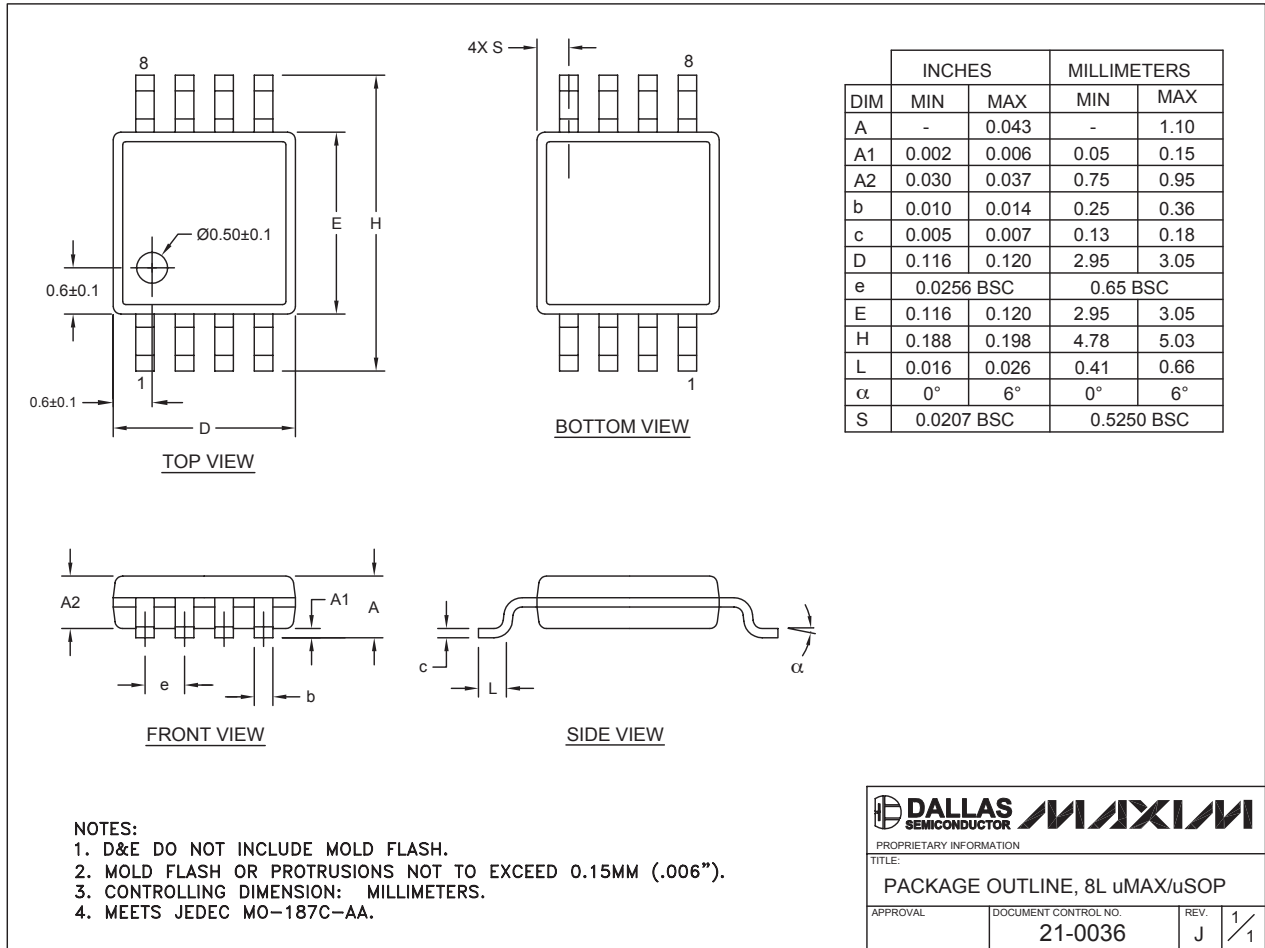

8LUMAXD/EPS

DALLAS SEMICONDUCTOR **MAXIM**

PROPRIETARY INFORMATION

TITLE:
PACKAGE OUTLINE, 8L uMAX/uSOP

APPROVAL	DOCUMENT CONTROL NO. 21-0036	REV. J	1/1
----------	---------------------------------	--------	-----

Ultra-Low-Distortion, +5V, 400MHz Op Amps with Disable

Package Information (continued)

(The package drawing(s) in this data sheet may not reflect the most current specifications. For the latest package outline information go to www.maxim-ic.com/packages.)

SOICN, EPS

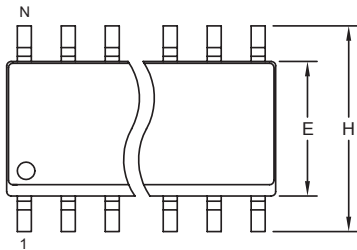

TOP VIEW

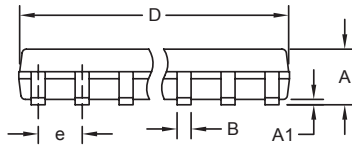

FRONT VIEW

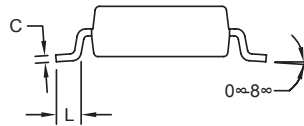

SIDE VIEW

DIM	INCHES		MILLIMETERS	
	MIN	MAX	MIN	MAX
A	0.053	0.069	1.35	1.75
A1	0.004	0.010	0.10	0.25
B	0.014	0.019	0.35	0.49
C	0.007	0.010	0.19	0.25
e	0.050 BSC		1.27 BSC	
E	0.150	0.157	3.80	4.00
H	0.228	0.244	5.80	6.20
L	0.016	0.050	0.40	1.27

VARIATIONS:

DIM	INCHES		MILLIMETERS		N	MS012
	MIN	MAX	MIN	MAX		
D	0.189	0.197	4.80	5.00	8	AA
D	0.337	0.344	8.55	8.75	14	AB
D	0.386	0.394	9.80	10.00	16	AC

NOTES:

1. D&E DO NOT INCLUDE MOLD FLASH.
2. MOLD FLASH OR PROTRUSIONS NOT TO EXCEED 0.15mm (.006").
3. LEADS TO BE COPLANAR WITHIN 0.10mm (.004").
4. CONTROLLING DIMENSION: MILLIMETERS.
5. MEETS JEDEC MS012.
6. N = NUMBER OF PINS.

DALLAS SEMICONDUCTOR		MAXIM	
<small>PROPRIETARY INFORMATION</small>			
TITLE: PACKAGE OUTLINE, .150" SOIC			
<small>APPROVAL</small>	<small>DOCUMENT CONTROL NO.</small> 21-0041	<small>REV.</small> B	<small>1/1</small>

Ultra-Low-Distortion, +5V, 400MHz Op Amps with Disable

Package Information (continued)

(The package drawing(s) in this data sheet may not reflect the most current specifications. For the latest package outline information go to www.maxim-ic.com/packages.)

MAX4265-MAX4270

QSOPEPS

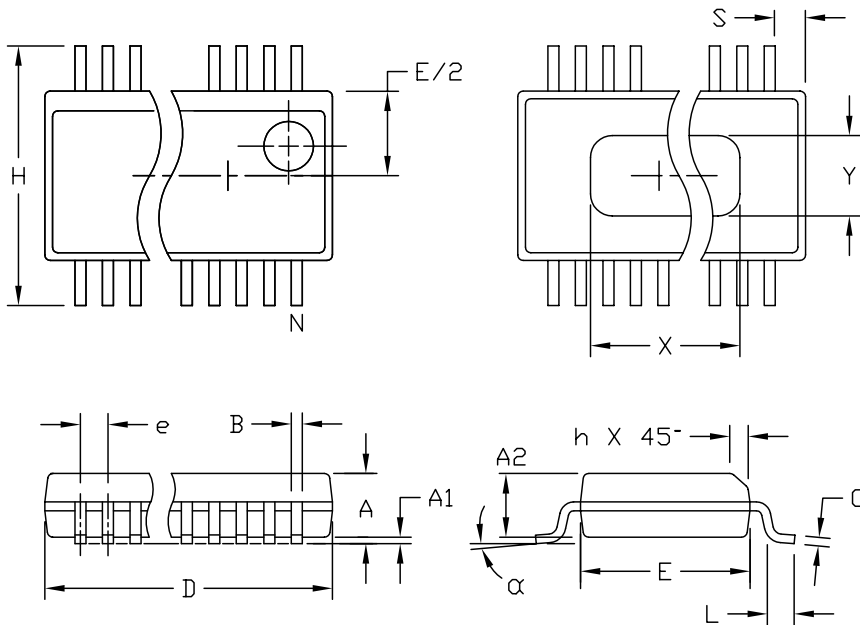

DIM	INCHES		MILLIMETERS	
	MIN	MAX	MIN	MAX
A	.061	.068	1.55	1.73
A1	.004	.0098	0.102	0.249
A2	.055	.061	1.40	1.55
B	.008	.012	0.20	0.31
C	.0075	.0098	0.191	0.249
D	SEE VARIATIONS			
E	.150	.157	3.81	3.99
e	.025 BSC		0.635 BSC	
H	.230	.244	5.84	6.20
h	.010	.016	0.25	0.41
L	.016	.035	0.41	0.89
N	SEE VARIATIONS			
X	SEE VARIATIONS			
Y	.071	.087	1.803	2.209
α	0°	8°	0°	8°

VARIATIONS:

DIM	INCHES		MILLIMETERS		N
	MIN.	MAX.	MIN.	MAX.	
D	.189	.196	4.80	4.98	16 AA
S	.0020	.0070	0.05	0.18	
X	.107	.123	2.72	3.12	
D	.337	.344	8.56	8.74	20 AB
S	.0500	.0550	1.270	1.397	
D	.337	.344	8.56	8.74	24 AC
S	.0250	.0300	0.635	0.762	
D	.386	.393	9.80	9.98	28 AD
S	.0250	.0300	0.635	0.762	
X	.271	.287	6.88	7.29	

NOTES:

1. D & E DO NOT INCLUDE MOLD FLASH OR PROTRUSIONS.
2. MOLD FLASH OR PROTRUSIONS NOT TO EXCEED .006" PER SIDE.
3. HEAT SLUG DIMENSIONS X AND Y APPLY ONLY TO 16 AND 28 LEAD POWER-QSOPEPS PACKAGES.
4. CONTROLLING DIMENSIONS: INCHES.
5. MEETS JEDEC MO137.

MAXIM

PROPRIETARY INFORMATION

TITLE:
PACKAGE OUTLINE, QSOPEPS, .150", .025" LEAD PITCH

APPROVAL	DOCUMENT CONTROL NO.	REV
	21-0055	C 1/1

Maxim cannot assume responsibility for use of any circuitry other than circuitry entirely embodied in a Maxim product. No circuit patent licenses are implied. Maxim reserves the right to change the circuitry and specifications without notice at any time.

Maxim Integrated Products, 120 San Gabriel Drive, Sunnyvale, CA 94086 408-737-7600 _____ 19

X-ON Electronics

Largest Supplier of Electrical and Electronic Components

Click to view similar products for [High Speed Operational Amplifiers](#) category:

Click to view products by [Maxim](#) manufacturer:

Other Similar products are found below :

[LT1809IS6#TRM](#) [NJU7047RB1-TE2](#) [LTC6226IS8#PBF](#) [LT1058ACN](#) [LT1206CR](#) [LT1058ISW](#) [THS4222DGNR](#) [JM38510/11905BPA](#)
[OPA2677IDDAR](#) [THS6042ID](#) [THS4221DBVR](#) [THS4081CD](#) [ADA4858-3ACPZ-R7](#) [LT6202IS5#TRMPBF](#) [LT1206CR#PBF](#)
[LT1813CDD#PBF](#) [LT1037IN8#PBF](#) [LTC6401CUD-20#PBF](#) [LT1192CN8#PBF](#) [LT1037ACN8#PBF](#) [LTC6253CTS8#TRMPBF](#)
[LT1399HVCS#PBF](#) [LT1993CUD-2#PBF](#) [LT1722CS8#PBF](#) [LT1208CN8#PBF](#) [LT1007ACN8#PBF](#) [LT1222CN8#PBF](#) [LT6203IDD#PBF](#)
[LT6411IUD#PBF](#) [LTC6400CUD-26#PBF](#) [LTC6400CUD-8#PBF](#) [LT6211IDD#PBF](#) [LT1810IMS8#PBF](#) [OP37EN8#PBF](#) [LT1360CS8](#)
[OPA2132PAG4](#) [OPA2353UA/2K5](#) [OPA2691I-14D](#) [OPA4353UA/2K5](#) [OPA690IDRG4](#) [LMH6723MFX/NOPB](#) [ADP5302ACPZ-3-R7](#)
[AD8000YRDZ](#) [AD8007AKSZ-REEL7](#) [AD8008ARMZ](#) [AD8009JRTZ-REEL7](#) [AD8010ANZ](#) [AD8012ARMZ](#) [AD8014ARTZ-REEL7](#)
[AD8016AREZ](#)