

Click [here](#) for production status of specific part numbers.

MAX44281

Ultra-Small, Ultra-Thin, 4-Bump Op Amp

General Description

The MAX44281 is the industry's first op amp in a 4-bump WLP package, designed for use in portable consumer and medical applications. This device is offered as a noninverting amplifier with gain (AV) of +1V/V, +2V/V, or +10V/V.

The device features rail-to-rail output, low 100 μ V input voltage offset, and 15MHz of bandwidth with only 700 μ A of supply current.

The device features shutdown functionality by pulling V_{DD} to ground. During shutdown, both the input and the output are high impedance.

The device is available in an ultra-small, 0.85mm x 0.85mm, 4-bump WLP package with 0.5mm height. It is specified over the -40°C to +125°C temperature range.

Applications

- 3G/4G Handsets
- Sensor Interfaces
- Portable Medical Devices
- Battery-Powered Devices
- General-Purpose Signal Processing
- Notebooks
- Transimpedance Amplifiers

Benefits and Features

- 4-Pin Amplifier Saves Board Space
 - 0.85mm x 0.85mm 4-Bump Thin WLP Package
 - Three Gain Versions Available
 - 1V/V (MAX44281O)
 - 2V/V (MAX44281V)
 - 10V/V (MAX44281U)
- Precision Specifications Support Most Precision Applications
 - Low 100 μ V Input Offset Voltage
 - Rail-to-Rail Output
 - 10pA Input Bias Current
 - 15MHz GBW
- Low Power Consumption Extends Battery Life in Portable Applications
 - 700 μ A Supply Current
 - Shutdown Input Through V_{DD}
 - 1.8V to 5.5V Supply Range

Ordering Information appears at end of data sheet.

Functional Diagrams

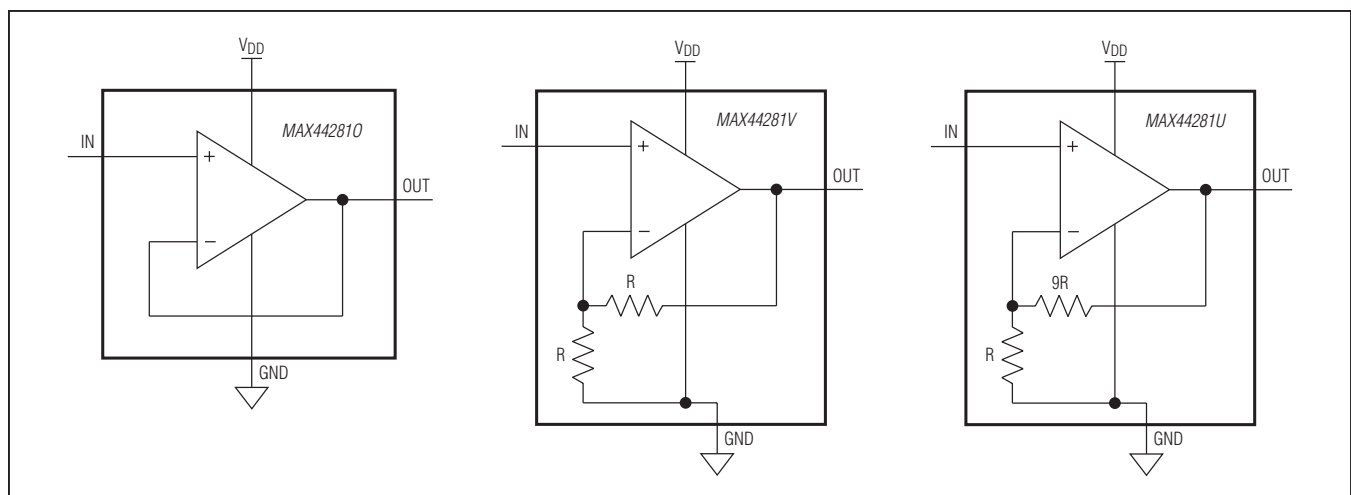

Absolute Maximum Ratings

V _{DD} to GND.....	-0.3V to +6V	Maximum Continuous Current into Any Pin	≤ 20mA
IN to GND.....	-0.3V to +6V	Operating Temperature Range	-40°C to +125°C
OUT to GND.....	(V _{GND} - 0.3V) to (V _{DD} + 0.3V)	Storage Temperature Range.....	-65°C to +150°C
Continuous Power Dissipation (T _A = +70°C)		Soldering Temperature (reflow)	+260°C
WLP (derate 9.7mW/°C above +70°C).....	303mW		

Stresses beyond those listed under “Absolute Maximum Ratings” may cause permanent damage to the device. These are stress ratings only, and functional operation of the device at these or any other conditions beyond those indicated in the operational sections of the specifications is not implied. Exposure to absolute maximum rating conditions for extended periods may affect device reliability.

Package Thermal Characteristics (Note 1)

WLP
 Junction-to-Ambient Thermal Resistance (θ_{JA})103°C/W

Note 1: Package thermal resistances were obtained using the method described in JEDEC specification JESD51-7, using a four-layer board. For detailed information on package thermal considerations, refer to www.maximintegrated.com/thermal-tutorial.

Electrical Characteristics

(V_{DD} = 3.3V, V_{GND} = 0V, R_L = 10kΩ to V_{DD}/2, T_A = T_{MIN} to T_{MAX}, unless otherwise noted. Typical values are at T_A = +25°C.) (Note 1)

PARAMETER	SYMBOL	CONDITIONS	MIN	TYP	MAX	UNITS
DC PERFORMANCE (Note 1)						
Input Voltage Range (Note 3)	V _{IN}	A _V = 1V/V (MAX44281O)	0.1		V _{DD} - 0.1	V
		A _V = 2V/V (MAX44281V)	0.05		(V _{DD} - 0.1)/2	
		A _V = 10V/V (MAX44281U)	0.01		(V _{DD} - 0.1)/10	
Gain Error	GE	A _V = 1V/V (MAX44281O)		0.01	0.02	%
		A _V = 2V/V (MAX44281V)		0.2	0.6	
		A _V = 10V/V (MAX44281U)		0.3	0.7	
Input Offset Voltage (Note 2)	V _{OS}	V _{IN} = 150mV, no load	A _V = 1	20	100	μV
			A _V = 2V/V	20	100	
			A _V = 10V/V	20	100	
Input Offset Voltage Drift (Note 2)	V _{OS} - TC			2	9	μV/°C
Input Bias Current (Note 2)	I _B	T _A = +25°C (Note 2)		1	10	pA
		T _A = -40°C to +125°C			2000	
Output Short-Circuit Current	I _{SC}	OUT to V _{DD} or GND		50		mA
Output Voltage Low	V _{OL}	R _{OUT} = 10kΩ			0.02	V
		R _{OUT} = 600Ω			0.1	

Electrical Characteristics (continued)

($V_{DD} = 3.3V$, $V_{GND} = 0V$, $R_L = 10k\Omega$ to $V_{DD}/2$, $T_A = T_{MIN}$ to T_{MAX} , unless otherwise noted. Typical values are at $T_A = +25^\circ C$.) (Note 1)

PARAMETER	SYMBOL	CONDITIONS	MIN	TYP	MAX	UNITS
Output Voltage High	V_{OH}	$R_{OUT} = 10k\Omega$	$V_{DD} - 0.1$			V
		$R_{OUT} = 600\Omega$	$V_{DD} - 0.1$			
Input Voltage-Noise Density	e_n	$A_V = 1V/V$, $f = 10kHz$	15			nV/ \sqrt{Hz}
		$A_V = 2V/V$, $f = 10kHz$	19			
		$A_V = 10V/V$, $f = 10kHz$	16			
Gain Bandwidth	GBW		15			MHz
Slew Rate	SR		8			V/ μs
Capacitive Load	C_{LOAD}	No sustained oscillations	100			pF
POWER-SUPPLY CHARACTERISTICS						
Power-Supply Range	V_{DD}	Guaranteed by PSRR	$T_A = -40^\circ C$ to $+125^\circ C$	1.8	5.5	V
			$T_A = 0^\circ C$ to $+70^\circ C$	1.7	5.5	
Power-Supply Rejection Ratio	PSRR		75	100		dB
Supply Current	I_{CC}	$V_{OUT} = V_{DD}/2$, no load		700	1200	μA
Shutdown Supply Current	I_{SHDN}				1	μA
Shutdown Threshold	V_{IL}				0.5	V
Turn-On Time	t_{ON}	$T_A = +25^\circ C$		10	20	ms
		$T_A = -40^\circ C$ to $+125^\circ C$		10	30	

Note 1: All devices are 100% production tested at $T_A = +25^\circ C$. Specifications over temperature limits are guaranteed by design.

Note 2: Guaranteed by design.

Note 3: Guaranteed by gain accuracy specifications.

Typical Operating Characteristics

($T_A = +25^\circ\text{C}$, unless otherwise noted.)

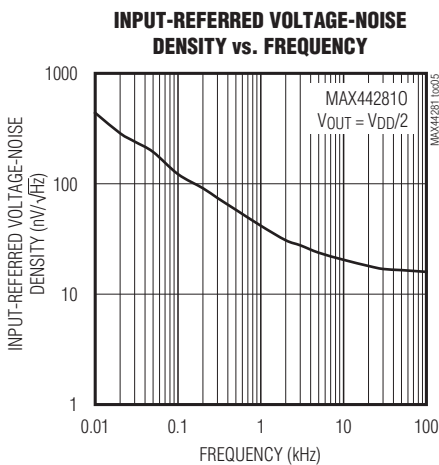
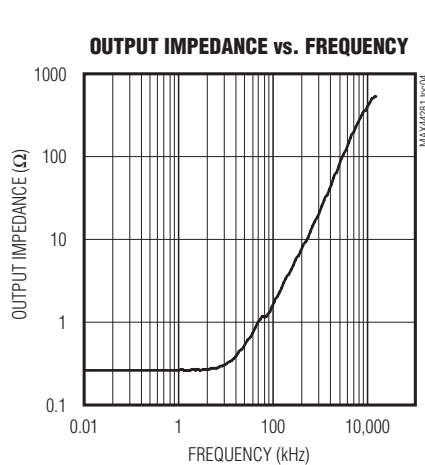
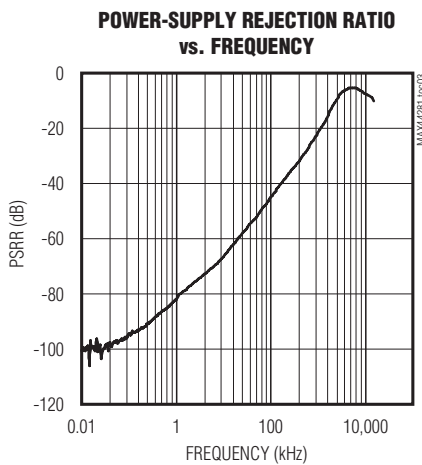
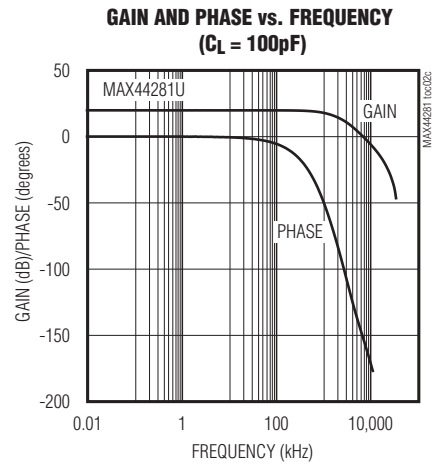
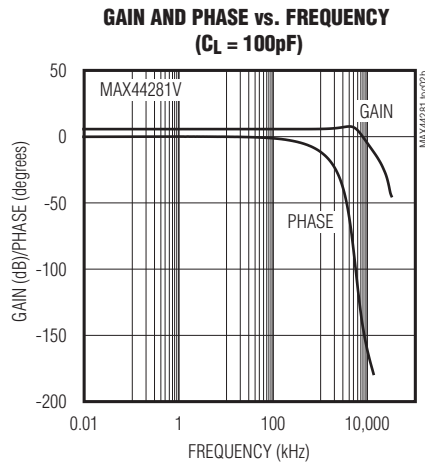
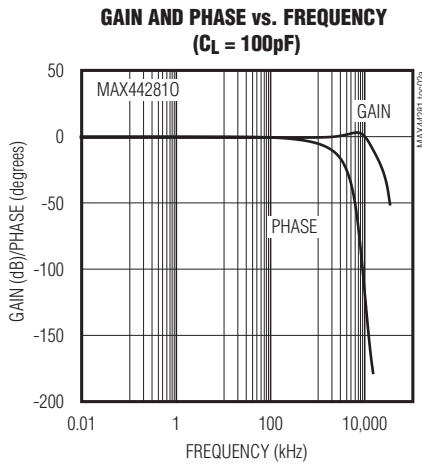
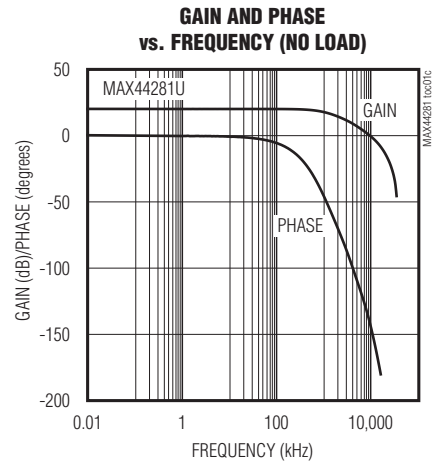
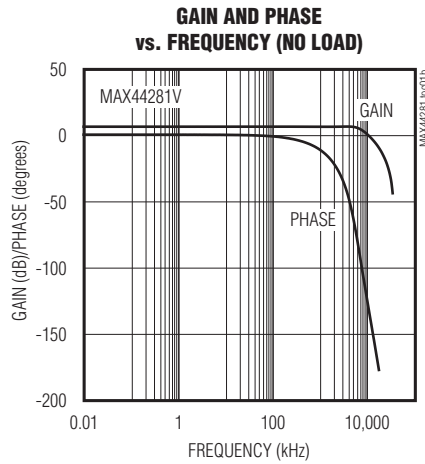
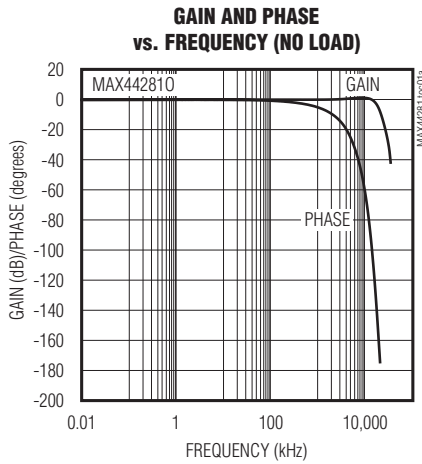

Typical Operating Characteristics (continued)

($T_A = +25^\circ\text{C}$, unless otherwise noted.)

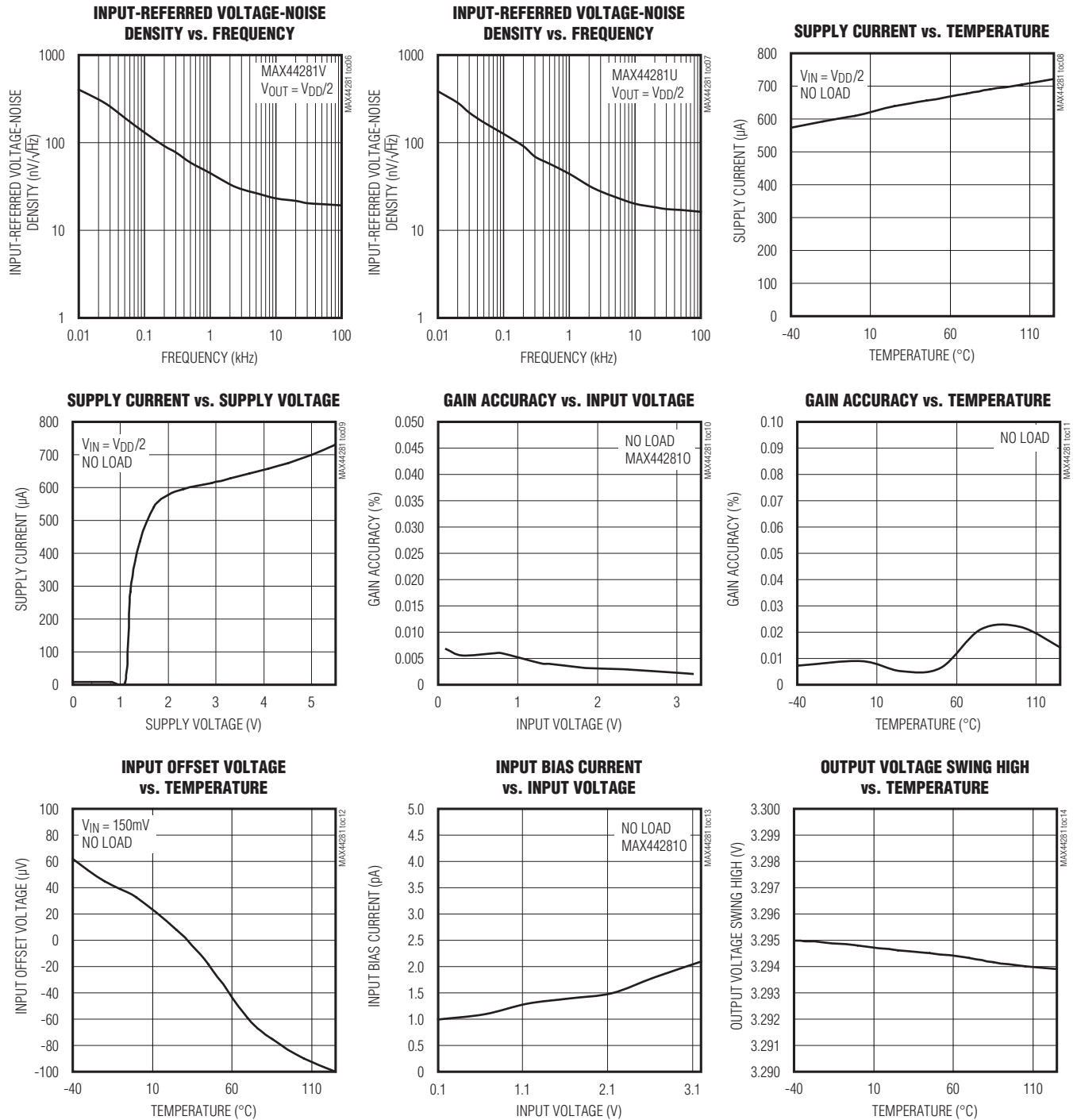

Typical Operating Characteristics (continued)

($T_A = +25^\circ\text{C}$, unless otherwise noted.)

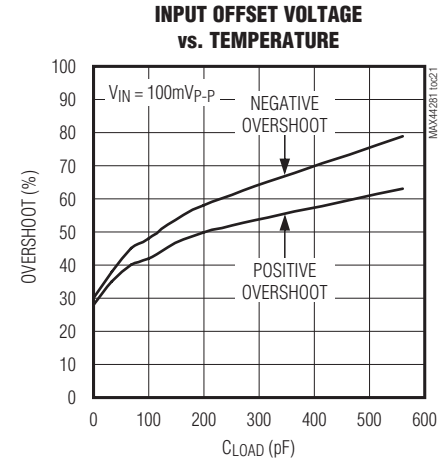
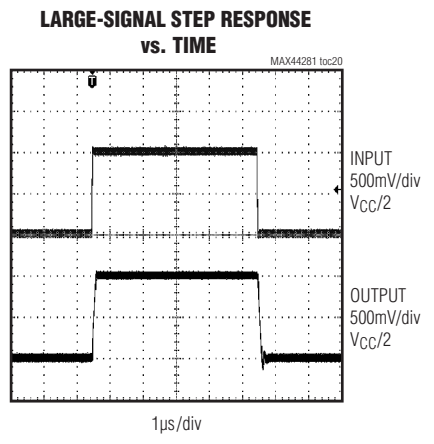
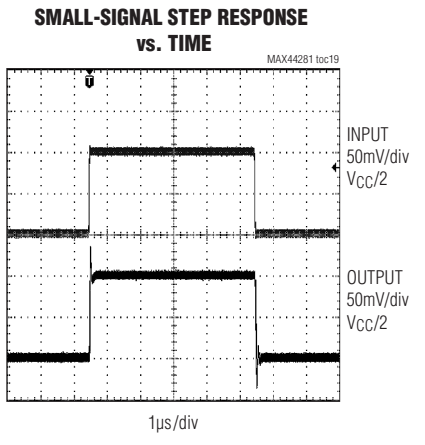
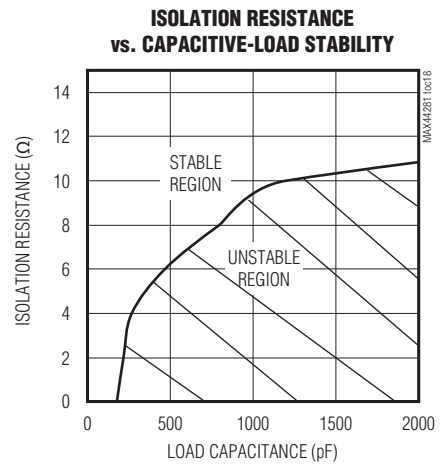
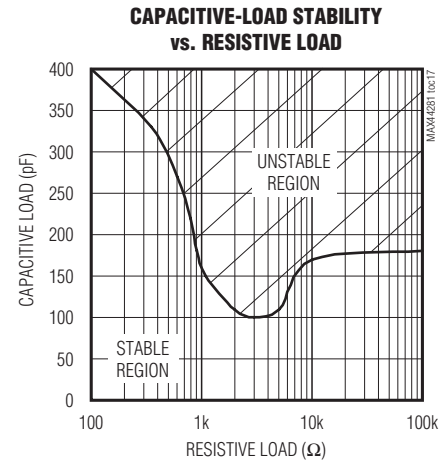
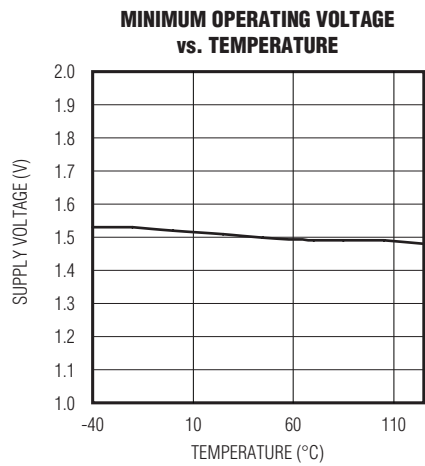
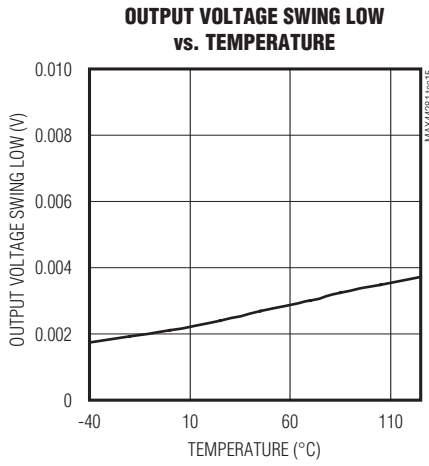

Bump Configuration

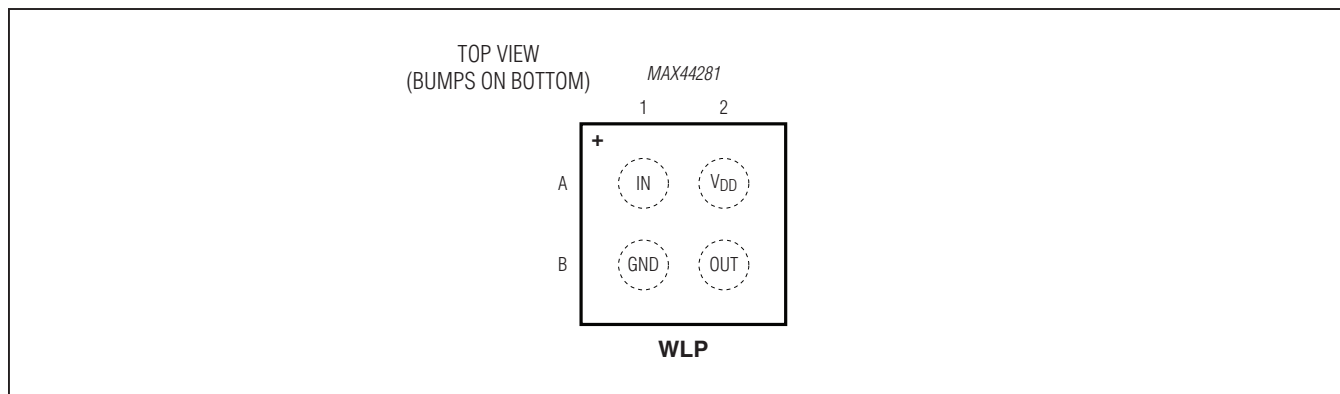

Bump Description

BUMP	NAME	FUNCTION
A1	IN	Input
A2	V _{DD}	Positive Supply Voltage
B1	GND	Ground
B2	OUT	Output

Detailed Description

Rail-to-Rail Output Stage

The MAX44281 is a high-bandwidth, low-power op amp in the smallest 4-bump WLP industry package. Its combination of precision, low-noise, and low-power specifications makes it ideal for use in a wide variety of sensor interface applications in portable consumer and medical equipment.

Shutdown Mode

The MAX44281 features shutdown functionality by pulling V_{DD} to ground. During shutdown, both the input and the output are high-impedance. The input and output of the MAX44281 enter a high-impedance state when the device enters shutdown. Since shutdown is triggered by lowering the supply voltage to below 0.5V, the ESD protection diodes at the output limit the high-Z voltage range of the output. Diode D2 in Figure 2, from the output of the amplifier to V_{DD} , is forward biased when the output voltage becomes too high in shutdown mode. The diodes combined with the low-voltage shutdown functionality effectively limit the high-impedance output range to plus and minus a diode voltage around ground ($\sim P$ 0.6V).

Driving Capacitive Loads

Driving a capacitive load can cause instability in many op amps, especially those with low quiescent current. The MAX44281 is stable for a range of capacitive loads to above 400pF. Adding a series resistor between the output and the load capacitor improves the circuit's response by isolating the load capacitance from the op amp's output. See the Isolation Resistance vs. Capacitive-Load Stability graph in the *Typical Operating Characteristics* section for details.

Applications Information

The MAX44281 features low input voltage offset and low bias current, which makes the device ideal for single-supply DC operations. However, its wide bandwidth and low noise make it suitable also for AC applications. The circuit in Figure 1 enables AC-coupled applications with the simple addition of two external resistors R1 and R2. Such resistors set the output bias voltage at midsupply. The values of R1 and R2 depend on the gain option of the device, according to the equation:

- $V_{DD} \times (R2/(R1 + R2)) = V_{DD}/(2 \times AV)$

Driver for Interfacing with the MAX11645 ADC

The MAX44281's tiny size and low noise make it a good fit for driving 12- to 16-bit resolution ADCs in space-constrained applications. The *Typical Application Circuit* shows the MAX44281 amplifier output connected to a lowpass filter driving the MAX11645 ADC. The MAX11645 is part of a family of 3V and 5V, 12-bit and 10-bit, 2-channel ADCs.

The MAX11645 offers sample rates up to 94ksps and measures two single-ended inputs or one differential input. These ADCs dissipate 670fA at the maximum sampling rate, but just 6 μ A at 1ksps and 0.5 μ A in shutdown. Offered in the ultra-tiny, 1.9mm x 2.2mm WLP and FMAX-8 packages, the MAX11645 ADCs are an ideal fit to pair with the MAX44281 amplifier in portable applications.

Where higher resolution is required, refer to the MAX1069 (14-bit) and MAX1169 (16-bit) ADC families.

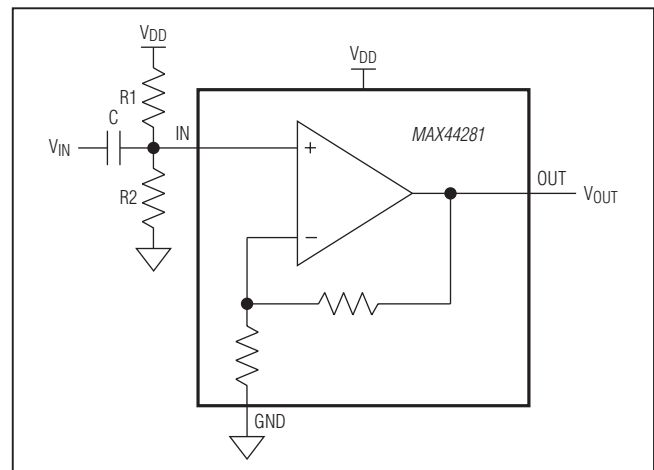

Figure 1. How to Use the MAX44281 in AC-Coupled Applications

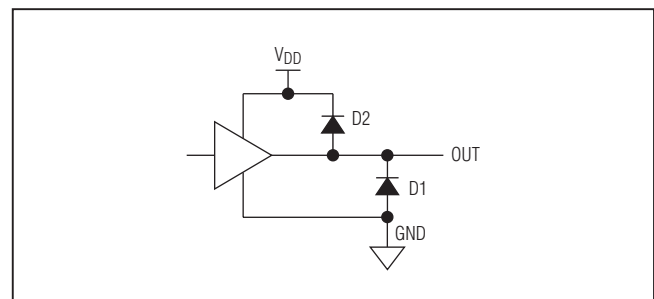
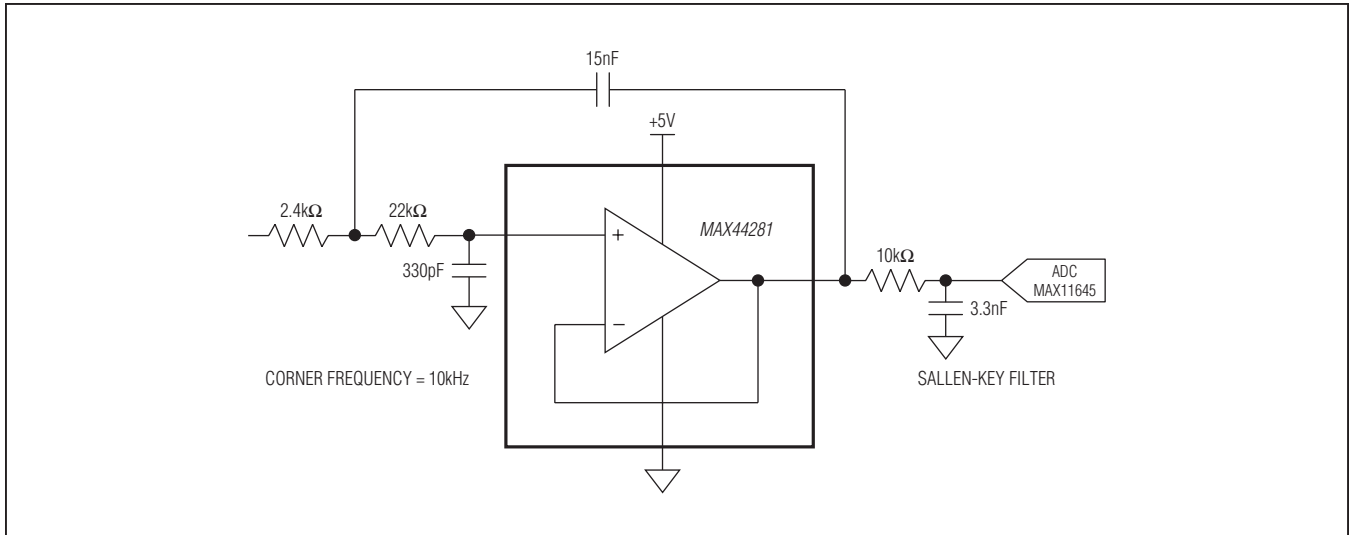

Figure 2. Output ESD Protection Diodes

Typical Application Circuit



WLP Applications Information

For the latest application details on WLP construction, dimensions, tape carrier information, PCB techniques, bump-pad layout, and recommended reflow temperature profile, as well as the latest information on reliability testing results, refer to Application Note 1891: *Wafer-Level Packaging (WLP) and Its Applications*.

Ordering Information

PART	TEMP RANGE	PIN-PACKAGE	FUNCTION
MAX44281OANS+T	-40°C to +125°C	4 WLP	Noninverting, $A_V = 1V/V$
MAX44281VANS+T	-40°C to +125°C	4 WLP	Noninverting, $A_V = 2V/V$
MAX44281UANS+T	-40°C to +125°C	4 WLP	Noninverting, $A_V = 10V/V$

+Denotes a lead(Pb)-free/RoHS-compliant package.

Package Information

For the latest package outline information and land patterns (footprints), go to www.maximintegrated.com/packages. Note that a "+", "#", or "-" in the package code indicates RoHS status only. Package drawings may show a different suffix character, but the drawing pertains to the package regardless of RoHS status.

PACKAGE TYPE	PACKAGE CODE	OUTLINE NO.	LAND PATTERN NO.
4 WLP	N40A0-1	21-0612	Refer to Application Note 1891

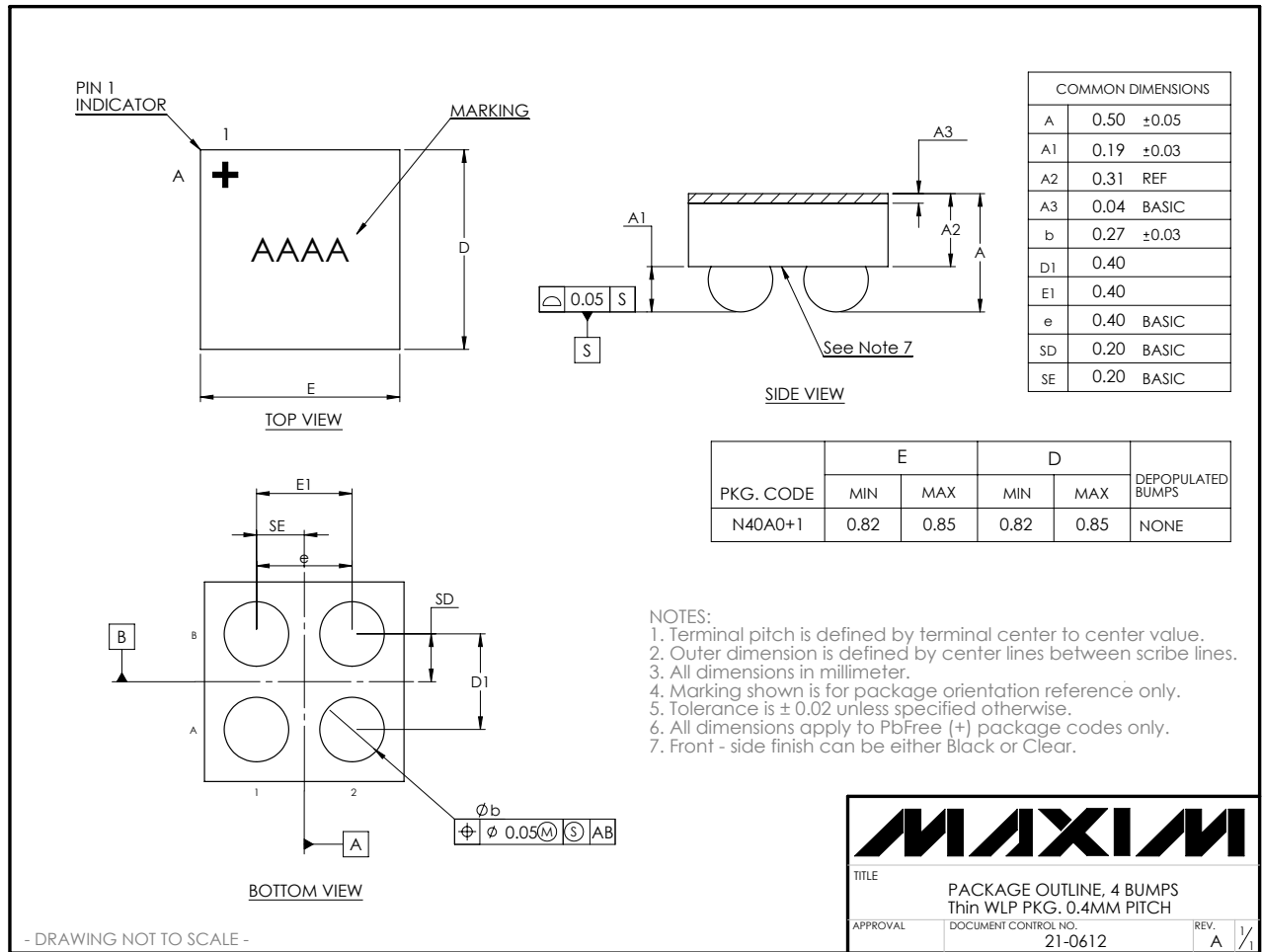

Revision History

REVISION NUMBER	REVISION DATE	DESCRIPTION	PAGES CHANGED
0	12/12	Initial release	—
1	1/13	Revised the <i>Typical Operating Characteristics</i> and released the MAX44281O	5, 6, 9
2	5/15	Updated <i>Benefits and Features</i> section	1
3	8/19	Updated <i>General Description</i> and <i>Benefits and Features</i> sections	1
4	2/20	Added package outline drawing	10

For pricing, delivery, and ordering information, please visit Maxim Integrated's online storefront at <https://www.maximintegrated.com/en/storefront/storefront.html>.

Maxim Integrated cannot assume responsibility for use of any circuitry other than circuitry entirely embodied in a Maxim Integrated product. No circuit patent licenses are implied. Maxim Integrated reserves the right to change the circuitry and specifications without notice at any time. The parametric values (min and max limits) shown in the Electrical Characteristics table are guaranteed. Other parametric values quoted in this data sheet are provided for guidance.

X-ON Electronics

Largest Supplier of Electrical and Electronic Components

Click to view similar products for [Amplifier IC Development Tools](#) category:

Click to view products by [Maxim](#) manufacturer:

Other Similar products are found below :

[AD8033AKS-EBZ](#) [AD8044AR-EBZ](#) [AD744JR-EBZ](#) [AD8023AR-EBZ](#) [AD848JR-EBZ](#) [ADA4922-1ACP-EBZ](#) [EVAL-ADCMP553BRMZ](#)
[EVAL-ADCMP608BKSZ](#) [MIOP 42109](#) [EVAL-ADCMP609BRMZ](#) [ADA4950-1YCP-EBZ](#) [MAX2634EVKIT](#) [ISL28158EVAL1Z](#) [MADL-](#)
[011014-001SMB](#) [AD8137YCP-EBZ](#) [EVAL-ADA4523-1ARMZ](#) [EVAL01-HMC1013LP4E](#) [MCP6XXXEV-AMP3](#) [MCP6XXXEV-AMP4](#)
[MCP6XXXEV-AMP2](#) [ISL28006FH-100EVAL1Z](#) [551012922-001/NOPB](#) [EVAL-ADCMP603BCPZ](#) [AMC1200EVM](#) [AD8417RM-EVALZ](#)
[DEM-OPA-SOT-1A](#) [DEM-OPA-SO-1C](#) [DEM-BUF-SOT-1A](#) [OPA2836IDGSEVM](#) [AD633-EVALZ](#) [AD8418R-EVALZ](#)
[ISL28433SOICEVAL1Z](#) [ISL28233SOICEVAL1Z](#) [ISL28208SOICEVAL2Z](#) [ISL28207SOICEVAL2Z](#) [ISL28006FH-50EVAL1Z](#)
[ISL28005FH-50EVAL1Z](#) [120257-HMC613LC4B](#) [DC1591A](#) [DC1150A](#) [DC1115A](#) [DC954A-C](#) [DC306A-A](#) [DC1192A](#) [131679-](#)
[HMC813LC4B](#) [OPA2835IDGSEVM](#) [LMH730220/NOPB](#) [MAAP-011246-1SMB](#) [118329-HMC627ALP5](#) [125932-HMC874LC3C](#)