



# ±15kV ESD-Protected, Low-Voltage, CMOS Analog Multiplexers/Switches

## General Description

The MAX4558/MAX4559/MAX4560 are low-voltage, CMOS analog ICs configured as an 8-to-1 multiplexer (MAX4558), a dual 4-to-1 multiplexer (MAX4559), and a triple single-pole/double-throw (SPDT) switch (MAX4560). Each switch is protected against ±15kV electrostatic discharge (ESD) shocks, without latchup or damage.

These CMOS devices can operate continuously from dual supplies of ±2V to ±6V or from a +2V to +12V single supply. Each switch can handle Rail-to-Rail® analog signals. The off-leakage current is only 1nA at +25°C or 10nA at +85°C max.

All digital inputs have +0.8V to +2.4V logic thresholds, ensuring TTL/CMOS-logic compatibility when using a single +5V supply or dual ±5V supplies.

## Applications

Battery-Operated Equipment  
 Audio and Video Signal Routing  
 Low-Voltage Data-Acquisition Systems  
 Communications Circuits  
 High-ESD Environments

## Features

- ◆ ESD-Protected X, Y, Z and X<sub>-</sub>, Y<sub>-</sub>, Z<sub>-</sub> Pins  
 ±15kV (Human Body Model)  
 ±12kV (IEC 1000-4-2, Air-Gap Discharge)  
 ±8kV (IEC 1000-4-2, Contact Discharge)
- ◆ Pin-Compatible with Industry-Standard  
 74HC4051/74HC4052/74HC4053
- ◆ Guaranteed On-Resistance  
 220Ω with Single +5V Supply  
 160Ω with ±5V Supply
- ◆ RON Match Between Channels: 2Ω (typ)
- ◆ Guaranteed Low leakage Currents  
 1nA Off-Leakage (at +25°C)  
 1nA On-Leakage (at +25°C)
- ◆ TTL-Compatible Inputs with +5V/±5V Supplies
- ◆ Low Distortion: < 0.02% (600Ω)
- ◆ Low Crosstalk: < -93dB (50Ω)
- ◆ High Off-Isolation: < -96dB (50Ω)

## Ordering Information

PART	TEMP. RANGE	PIN-PACKAGE
MAX4558CEE	0°C to +70°C	16 QSOP
MAX4558CSE	0°C to +70°C	16 Narrow SO
MAX4558CPE	0°C to +70°C	16 Plastic DIP

Ordering Information continued at end of data sheet.

Rail-to-Rail is a registered trademark of Nippon Motorola, Ltd.

## Pin Configurations/Functional Diagrams

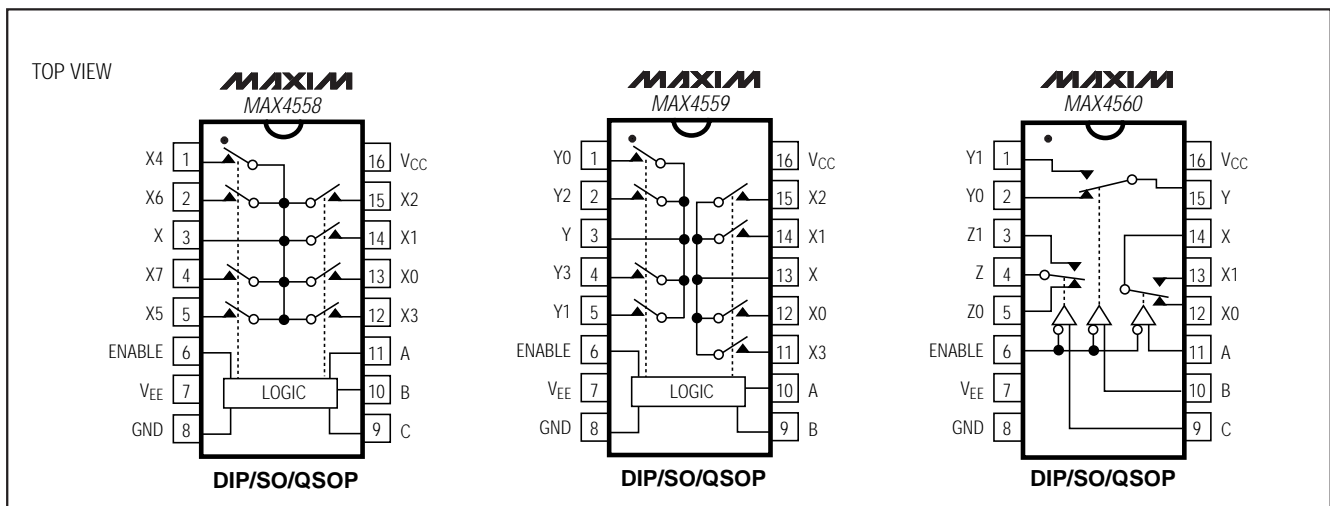

# ±15kV ESD-Protected, Low-Voltage, CMOS Analog Multiplexers/Switches

## ABSOLUTE MAXIMUM RATINGS

(Voltages referenced to V<sub>EE</sub>)

V <sub>CC</sub> .....	-0.3V to +13V
Voltage into Any Terminal (Note 1).... (V <sub>EE</sub> - 0.3V) to (V <sub>CC</sub> + 0.3V)	
Continuous Current into Any Terminal .....	±10mA
Peak Current, X, Y, Z, X <sub>-</sub> , Y <sub>-</sub> , Z <sub>-</sub> (pulsed at 1ms, 10% duty cycle) .....	±30mA
ESD per Method IEC 1000-4-2 (X, Y, Z, X <sub>-</sub> , Y <sub>-</sub> , Z <sub>-</sub> )	
Air-Gap Discharge.....	±12kV
Contact Discharge.....	±8kV
ESD per Method 3015.7	
V <sub>CC</sub> , V <sub>EE</sub> , A, B, C, ENABLE, GND .....	±2.5kV
X, Y, Z, X <sub>-</sub> , Y <sub>-</sub> , Z <sub>-</sub> .....	±15kV

Continuous Power Dissipation (T<sub>A</sub> = +70°C)

QSOP (derate 8.00mW/°C above +70°C).....	640mW
Narrow SO (derate 8.70mW/°C above +70°C) .....	696mW
DIP (derate 10.53mW/°C above +70°C) .....	842mW
Operating Temperature Ranges	
MAX45 <sub>-</sub> C_E .....	0°C to +70°C
MAX45 <sub>-</sub> E_E .....	-40°C to +85°C
Storage Temperature Range.....	-65°C to +150°C
Lead Temperature (soldering, 10sec).....	+300°C

**Note 1:** Signals on any terminal exceeding V<sub>CC</sub> or V<sub>EE</sub> are clamped by internal diodes. Limit forward diode current to maximum current rating.

Stresses beyond those listed under "Absolute Maximum Ratings" may cause permanent damage to the device. These are stress ratings only, and functional operation of the device at these or any other conditions beyond those indicated in the operational sections of the specifications is not implied. Exposure to absolute maximum rating conditions for extended periods may affect device reliability.

## ELECTRICAL CHARACTERISTICS—Dual ±5V Supplies

(V<sub>CC</sub> = +4.5V to +5.5V, V<sub>EE</sub> = -4.5V to -5.5V, V<sub>H</sub> = +2.4V, V<sub>L</sub> = +0.8V, T<sub>A</sub> = T<sub>MIN</sub> to T<sub>MAX</sub>, unless otherwise noted. Typical values are at T<sub>A</sub> = +25°C.)

PARAMETER	SYMBOL	CONDITIONS	T <sub>A</sub>	MIN	TYP	MAX	UNITS	
<b>ANALOG SWITCH</b>								
Analog Signal Range	V <sub>X-</sub> , V <sub>Y-</sub> , V <sub>Z-</sub> , V <sub>X</sub> , V <sub>Y</sub> , V <sub>Z</sub>		C, E	V-		V+	V	
On-Resistance	R <sub>ON</sub>	V <sub>CC</sub> = 4.5V; V <sub>EE</sub> = -4.5V; I <sub>X</sub> , I <sub>Y</sub> , I <sub>Z</sub> = 1mA; V <sub>X-</sub> , V <sub>Y-</sub> , V <sub>Z-</sub> = ±3V	+25°C		110	160	Ω	
			C, E			180		
On-Resistance Match Between Channels (Note 3)	ΔR <sub>ON</sub>	V <sub>CC</sub> = 4.5V; V <sub>EE</sub> = -4.5V; I <sub>X</sub> , I <sub>Y</sub> , I <sub>Z</sub> = 1mA; V <sub>X-</sub> , V <sub>Y-</sub> , V <sub>Z-</sub> = ±3V	+25°C		2	6	Ω	
			C, E			8		
On-Resistance Flatness (Note 4)	R <sub>FLAT(ON)</sub>	V <sub>CC</sub> = 4.5V; V <sub>EE</sub> = -4.5V; I <sub>X</sub> , I <sub>Y</sub> , I <sub>Z</sub> = 1mA; V <sub>X-</sub> , V <sub>Y-</sub> , V <sub>Z-</sub> = -3V, 0V, 3V	+25°C		3	8	Ω	
			C, E			10		
X <sub>-</sub> , Y <sub>-</sub> , Z <sub>-</sub> Off-Leakage Current (Note 5)	I <sub>X(OFF)</sub> , I <sub>Y(OFF)</sub> , I <sub>Z(OFF)</sub>	V <sub>CC</sub> = 5.5V; V <sub>EE</sub> = -5.5V; V <sub>X-</sub> , V <sub>Y-</sub> , V <sub>Z-</sub> = 4.5V, -4.5V; V <sub>X</sub> , V <sub>Y</sub> , V <sub>Z</sub> = -4.5V, 4.5V	+25°C	-1	0.002	1	nA	
			C, E	-10		10		
X, Y, Z Off-Leakage Current (Note 5)	I <sub>X(OFF)</sub> , I <sub>Y(OFF)</sub> , I <sub>Z(OFF)</sub>	V <sub>CC</sub> = 5.5V; V <sub>EE</sub> = -5.5V; V <sub>X-</sub> , V <sub>Y-</sub> , V <sub>Z-</sub> = 4.5V, -4.5V; V <sub>X</sub> , V <sub>Y</sub> , V <sub>Z</sub> = -4.5V, 4.5V	MAX4558	+25°C	-2	0.002	2	nA
				C, E	-20		20	
			MAX4559 MAX4560	+25°C	-1	0.002	1	
X, Y, Z On-Leakage Current (Note 5)	I <sub>X(ON)</sub> , I <sub>Y(ON)</sub> , I <sub>Z(ON)</sub>	V <sub>CC</sub> = 5.5V; V <sub>EE</sub> = -5.5V; V <sub>X-</sub> , V <sub>Y-</sub> , V <sub>Z-</sub> = 4.5V, 4.5V; V <sub>X</sub> , V <sub>Y</sub> , V <sub>Z</sub> = 4.5V, -4.5V	MAX4558	+25°C	-2	0.002	2	nA
				C, E	-20		20	
			MAX4559 MAX4560	+25°C	-1	0.002	1	
			C, E	-10	0.002	10		

# ±15kV ESD-Protected, Low-Voltage, CMOS Analog Multiplexers/Switches

## ELECTRICAL CHARACTERISTICS—Dual ±5V Supplies (continued)

(V<sub>CC</sub> = +4.5V to +5.5V, V<sub>EE</sub> = -4.5V to -5.5V, V<sub>H</sub> = +2.4V, V<sub>L</sub> = +0.8V, T<sub>A</sub> = T<sub>MIN</sub> to T<sub>MAX</sub>, unless otherwise noted. Typical values are at T<sub>A</sub> = +25°C.)

PARAMETER	SYMBOL	CONDITIONS	T <sub>A</sub>	MIN	TYP (Note 2)	MAX	UNITS
<b>DIGITAL I/O</b>							
Input Logic High	V <sub>A-</sub> , V <sub>B-</sub> , V <sub>C-</sub> , V <sub>EN</sub>		C, E	2.4			V
Input Logic Low	V <sub>A-</sub> , V <sub>B-</sub> , V <sub>C-</sub> , V <sub>EN</sub>		C, E			0.8	V
Input Current Logic High or Low	V <sub>A-</sub> , V <sub>B-</sub> , V <sub>C-</sub> , V <sub>EN</sub>	V <sub>A</sub> , V <sub>B</sub> , V <sub>C</sub> , V <sub>EN</sub> = V <sub>CC</sub> or 0	C, E	-1		1	μA
<b>POWER SUPPLY</b>							
Power-Supply Range		V <sub>CC</sub> , V <sub>EE</sub>	C, E	±2		±6	V
Supply Current, V <sub>CC</sub> or V <sub>EE</sub>	I <sub>CC</sub>	V <sub>CC</sub> = 5.5V; V <sub>EE</sub> = -5.5V; V <sub>A</sub> , V <sub>B</sub> , V <sub>C</sub> , V <sub>EN</sub> = 0 or V <sub>CC</sub>	+25°C C, E	-1 -10		1 10	μA
<b>SWITCH DYNAMIC CHARACTERISTICS</b>							
Turn-On Time	t <sub>ON</sub>	V <sub>X-</sub> , V <sub>Y-</sub> , V <sub>Z-</sub> = 3V; R <sub>L</sub> = 300Ω; C <sub>L</sub> = 35pF; Figure 1	+25°C C, E		90 175	150	ns
Turn-Off Time	t <sub>OFF</sub>	V <sub>X-</sub> , V <sub>Y-</sub> , V <sub>Z-</sub> = 3V; R <sub>L</sub> = 300Ω; C <sub>L</sub> = 35pF; Figure 1	+25°C C, E		55 150	120	ns
Address Transition Time	t <sub>TRANS</sub>	V <sub>X-</sub> , V <sub>Y-</sub> , V <sub>Z-</sub> = 3V; R <sub>L</sub> = 300Ω; C <sub>L</sub> = 35pF; Figure 1	+25°C C, E		90 175	150	ns
Break-Before-Make Delay	t <sub>OPEN</sub>	V <sub>X-</sub> , V <sub>Y-</sub> , V <sub>Z-</sub> = 3V; R <sub>L</sub> = 300Ω; C <sub>L</sub> = 35pF; Figure 2	+25°C	4	15		ns
Charge Injection	Q	V <sub>X</sub> , V <sub>Y</sub> , V <sub>Z</sub> = 0; R <sub>S</sub> = 0; C <sub>L</sub> = 1nF; Figure 3	+25°C		2.4		pC
V <sub>X-</sub> , V <sub>Y-</sub> , V <sub>Z-</sub> Off-Capacitance	C <sub>X(OFF)</sub> , C <sub>Y(OFF)</sub> , C <sub>Z(OFF)</sub>	V <sub>X-</sub> , V <sub>Y-</sub> , V <sub>Z-</sub> = 0; f = 1MHz; Figure 5	+25°C		2.5		pF
V <sub>X</sub> , V <sub>Y</sub> , V <sub>Z</sub> Off-Capacitance	C <sub>X(OFF)</sub> , C <sub>Y(OFF)</sub> , C <sub>Z(OFF)</sub>	V <sub>X</sub> , V <sub>Y</sub> , V <sub>Z</sub> = GND; f = 1MHz; Figure 5	+25°C		10 6 4		pF
Switch On-Capacitance	C <sub>ON</sub>	V <sub>X-</sub> , V <sub>Y-</sub> , V <sub>Z-</sub> = GND; f = 1MHz; Figure 5	+25°C		15 11 9		pF

MAX4558/MAX4559/MAX4560

# ±15kV ESD-Protected, Low-Voltage, CMOS Analog Multiplexers/Switches

## ELECTRICAL CHARACTERISTICS—Dual ±5V Supplies (continued)

(V<sub>CC</sub> = +4.5V to +5.5V, V<sub>EE</sub> = -4.5V to -5.5V, V<sub>H</sub> = +2.4V, V<sub>L</sub> = +0.8V, T<sub>A</sub> = T<sub>MIN</sub> to T<sub>MAX</sub>, unless otherwise noted. Typical values are at T<sub>A</sub> = +25°C.)

PARAMETER	SYMBOL	CONDITIONS	T <sub>A</sub>	MIN	TYP (Note 2)	MAX	UNITS
Off-Isolation	V <sub>ISO</sub>	C <sub>L</sub> = 15pF; R <sub>L</sub> = 50Ω; f = 100kHz; V <sub>X-</sub> , V <sub>Y-</sub> , V <sub>Z-</sub> = 1V <sub>RMS</sub> ; Figure 4	+25°C		-96		dB
Channel-to-Channel Crosstalk	V <sub>CT</sub>	C <sub>L</sub> = 15pF; R <sub>L</sub> = 50Ω; f = 100kHz; V <sub>X-</sub> , V <sub>Y-</sub> , V <sub>Z-</sub> = 1V <sub>RMS</sub> ; Figure 4	+25°C		-93		dB
Total Harmonic Distortion	THD	R <sub>L</sub> = 600Ω; V <sub>X-</sub> , V <sub>Y-</sub> , V <sub>Z-</sub> = 5V <sub>p-p</sub> ; f = 20Hz to 20kHz	+25°C		0.02		%
ESD SCR Positive Holding Current	I <sub>H+</sub>		+25°C		110		mA
			+85°C		70		
ESD SCR Negative Holding Current	I <sub>H-</sub>		+25°C		95		mA
			+85°C		65		

## ELECTRICAL CHARACTERISTICS—Single +5V Supply

(V<sub>CC</sub> = +4.5V to +5.5V, V<sub>EE</sub> = 0, V<sub>H</sub> = +2.4V, V<sub>L</sub> = +0.8V, T<sub>A</sub> = T<sub>MIN</sub> to T<sub>MAX</sub>, unless otherwise noted. Typical values are at T<sub>A</sub> = +25°C.)

PARAMETER	SYMBOL	CONDITIONS	T <sub>A</sub>	MIN	TYP (Note 2)	MAX	UNITS	
<b>ANALOG SWITCH</b>								
Analog Signal Range	V <sub>X-</sub> , V <sub>Y-</sub> , V <sub>Z-</sub> , V <sub>X</sub> , V <sub>Y</sub> , V <sub>Z</sub>		C, E	0		V+	V	
On-Resistance	R <sub>ON</sub>	V <sub>CC</sub> = 4.5V; I <sub>X</sub> , I <sub>Y</sub> , I <sub>Z</sub> = 1mA; V <sub>X</sub> , V <sub>Y</sub> , V <sub>Z</sub> = 3V	+25°C		150	220	Ω	
			C, E			350		
On-Resistance Match Between Channels (Note 3, 6)	ΔR <sub>ON</sub>	V <sub>CC</sub> = 4.5V; I <sub>X</sub> , I <sub>Y</sub> , I <sub>Z</sub> = 1mA; V <sub>X</sub> , V <sub>Y</sub> , V <sub>Z</sub> = 3V	+25°C		3	10	Ω	
			C, E			12		
X <sub>-</sub> , Y <sub>-</sub> , Z <sub>-</sub> Off-Leakage Current (Note 6)	I <sub>X(OFF)</sub> , I <sub>Y(OFF)</sub> , I <sub>Z(OFF)</sub>	V <sub>CC</sub> = 5.5V; V <sub>X</sub> , V <sub>Y</sub> , V <sub>Z</sub> = 1V, 4.5V, V <sub>X</sub> , V <sub>Y</sub> , V <sub>Z</sub> = 4.5V, 1V	+25°C	-1	0.002	1	nA	
			C, E			10		
X, Y, Z Off-Leakage Current (Note 6)	I <sub>X(OFF)</sub> , I <sub>Y(OFF)</sub> , I <sub>Z(OFF)</sub>	V <sub>CC</sub> = 5.5V; V <sub>X-</sub> , V <sub>Y-</sub> , V <sub>Z-</sub> = 1V, 4.5V; V <sub>X</sub> , V <sub>Y</sub> , V <sub>Z</sub> = 4.5V, 1V	MAX4558	+25°C	-2	0.002	2	nA
				C, E			20	
			MAX4559 MAX4560	+25°C	-1	0.002	1	
				C, E			10	
X, Y, Z On-Leakage Current (Note 6)	I <sub>X(ON)</sub> , I <sub>Y(ON)</sub> , I <sub>Z(ON)</sub>	V <sub>CC</sub> = 5.5V; V <sub>X-</sub> , V <sub>Y-</sub> , V <sub>Z-</sub> = 1V, 4.5V; V <sub>X</sub> , V <sub>Y</sub> , V <sub>Z</sub> = 1V, 4.5V	MAX4558	+25°C	-2	0.002	2	nA
				C, E			20	
			MAX4559 MAX4560	+25°C	-1	0.002	1	
				C, E			10	

# $\pm 15\text{kV}$ ESD-Protected, Low-Voltage, CMOS Analog Multiplexers/Switches

## ELECTRICAL CHARACTERISTICS—Single +5V Supply (continued)

( $V_{CC} = +4.5\text{V}$  to  $+5.5\text{V}$ ,  $V_{EE} = 0$ ,  $V_{H} = +2.4\text{V}$ ,  $V_{L} = +0.8\text{V}$ ,  $T_A = T_{MIN}$  to  $T_{MAX}$ , unless otherwise noted. Typical values are at  $T_A = +25^\circ\text{C}$ .)

PARAMETER	SYMBOL	CONDITIONS	$T_A$	MIN	TYP (Note 2)	MAX	UNITS
<b>DIGITAL I/O</b>							
Input Logic High	$V_{A\_}, V_{B\_}, V_{C\_}, V_{EN}$		C, E	2.4			V
Input Logic Low	$V_{A\_}, V_{B\_}, V_{C\_}, V_{EN}$		C, E			0.8	V
Input Current Logic High or Low	$V_{A\_}, V_{B\_}, V_{C\_}, V_{EN}$	$V_A, V_B, V_C, V_{EN} = V_{CC}$ or 0	C, E	-1		1	$\mu\text{A}$
<b>SWITCH DYNAMIC CHARACTERISTICS</b> (Note 6)							
Turn-On Time	$t_{ON}$	$V_{X\_}, V_{Y\_}, V_{Z\_} = 3\text{V}$ ; $R_L = 300\Omega$ ; $C_L = 35\text{pF}$ ; Figure 1	+25°C	110	250		ns
			C, E		300		
Turn-Off Time	$t_{OFF}$	$V_{X\_}, V_{Y\_}, V_{Z\_} = 3\text{V}$ ; $R_L = 300\Omega$ ; $C_L = 35\text{pF}$ ; Figure 1	+25°C	50	150		ns
			C, E		200		
Address Transition Time	$t_{TRANS}$	$V_{X\_}, V_{Y\_}, V_{Z\_} = 3\text{V}$ ; $R_L = 300\Omega$ ; $C_L = 35\text{pF}$ ; Figure 1	+25°C	110	250		ns
			C, E		300		
Break-Before-Make Delay	$t_{OPEN}$	$V_{X\_}, V_{Y\_}, V_{Z\_} = 3\text{V}$ ; $R_L = 300\Omega$ ; $C_L = 35\text{pF}$ ; Figure 3	C, E	10			ns
Charge Injection	Q	$V_X, V_Y, V_Z = 2.5\text{V}$ ; $R_S = 0$ ; $C_L = 1\text{nF}$ ; Figure 3	+25°C		1		pC
<b>POWER SUPPLY</b>							
$V_{CC}$ Supply Current	$I_{CC}$	$V_{CC} = 5.5\text{V}$ ; $V_{AH}, V_{BH}, V_{CH}, V_{EN} = 0$ or $V_{CC}$	+25°C	-1		1	$\mu\text{A}$
			C, E		-10	10	
Power-Supply Range		$V_{CC}, V_{EE}$	C, E	+2		+12	V

MAX4558/MAX4559/MAX4560

# $\pm 15\text{kV}$ ESD-Protected, Low-Voltage, CMOS Analog Multiplexers/Switches

## ELECTRICAL CHARACTERISTICS—Single +3V Supply

( $V_{CC} = +2.7\text{V}$  to  $+3.6\text{V}$ ,  $V_H = +2.0\text{V}$ ,  $V_L = +0.8\text{V}$ ,  $T_A = T_{MIN}$  to  $T_{MAX}$ , unless otherwise noted. Typical values are at  $T_A = +25^\circ\text{C}$ .)

PARAMETER	SYMBOL	CONDITIONS	$T_A$	MIN	TYP (Note 2)	MAX	UNITS
<b>ANALOG SWITCH</b>							
On-Resistance	$R_{ON}$	$V_{CC} = 2.7\text{V}$ ; $I_X, I_Y, I_Z = 0.1\text{mA}$ ; $V_X, V_Y, V_Z = 1.5\text{V}$	+25°C	220	400		$\Omega$
			C, E			450	
<b>DIGITAL I/O</b>							
Input Logic High	$V_{A-}, V_{B-}, V_{C-}, V_{EN}$		C, E	1.5			V
Input Logic Low	$V_{A-}, V_{B-}, V_{C-}, V_{EN}$		C, E		0.5		V
Input Current Logic High or Low	$V_{A-}, V_{B-}, V_{C-}, V_{EN}$	$V_A, V_B, V_C, V_{EN} = V_{CC}$ or 0	C, E	-1		1	$\mu\text{A}$
<b>SWITCH DYNAMIC CHARACTERISTICS</b> (Note 6)							
Turn-On Time	$t_{ON}$	$V_{X-}, V_{Y-}, V_{Z-} = 1.5\text{V}$ ; $R_L = 1\text{k}\Omega$ ; $C_L = 35\text{pF}$ ; Figure 1	+25°C	180	350		ns
			C, E			400	
Turn-Off Time	$t_{OFF}$	$V_{X-}, V_{Y-}, V_{Z-} = 1.5\text{V}$ ; $R_L = 1\text{k}\Omega$ ; $C_L = 35\text{pF}$ ; Figure 1	+25°C	90	250		ns
			C, E			300	
Address Transition Time	$t_{TRANS}$	$V_{X-}, V_{Y-}, V_{Z-} = 1.5\text{V}$ ; $R_L = 1\text{k}\Omega$ ; $C_L = 35\text{pF}$ ; Figure 1	+25°C	180	350		ns
			C, E			400	
Break-Before-Make Delay	$t_{OPEN}$	$V_{X-}, V_{Y-}, V_{Z-} = 1.5\text{V}$ ; $R_L = 1\text{k}\Omega$ ; $C_L = 35\text{pF}$ ; Figure 2	C, E	1.5			ns
Charge Injection	Q	$V_X, V_Y, V_Z = 1.5\text{V}$ ; $R_S = 0$ ; $C_L = 1\text{nF}$ ; Figure 3	+25°C		0.5		pC
<b>POWER SUPPLY</b>							
$V_{CC}$ Supply Current	$I_{CC}$	$V_{CC} = 3.6\text{V}$ ; $V_{A-}, V_{B-}, V_{C-}, V_{EN} = 0$ or $V_{CC}$	+25°C	1	0.5	1	$\mu\text{A}$
			C, E	-10		10	

**Note 2:** The algebraic convention is used in this data sheet; the most negative value is shown in the minimum column.

**Note 3:**  $\Delta R_{ON} = R_{ON(MAX)} - R_{ON(MIN)}$ .

**Note 4:** Flatness is defined as the difference between the maximum and minimum value of on-resistance as measured over the specified analog signal ranges; i.e.,  $V_{ON} = 3\text{V}$  to 0 and 0 to  $-3\text{V}$ .

**Note 5:** Leakage parameters are 100% tested at the maximum-rated hot operating temperature and are guaranteed by correlation at  $T_A = +25^\circ\text{C}$ .

**Note 6:** Guaranteed by design, not production tested.

# ±15kV ESD-Protected, Low-Voltage, CMOS Analog Multiplexers/Switches

## Typical Operating Characteristics

( $V_{CC} = +5V$ ,  $V_{EE} = -5V$ ,  $T_A = +25^\circ C$ , unless otherwise noted.)

MAX4558/MAX4559/MAX4560

**ON-RESISTANCE vs.  $V_X, V_Y, V_Z$  (DUAL SUPPLIES)**



**ON-RESISTANCE vs.  $V_X, V_Y, V_Z$  (SINGLE SUPPLY)**

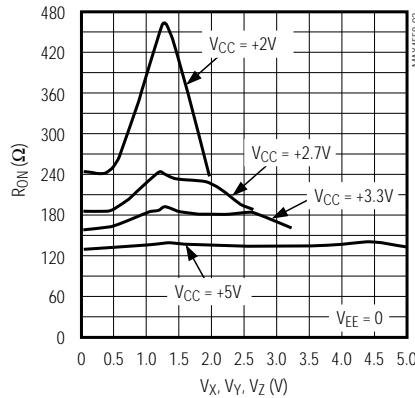

**ON-RESISTANCE vs.  $V_X, V_Y, V_Z$  AND TEMPERATURE (DUAL SUPPLIES)**



**ON-RESISTANCE vs.  $V_X, V_Y, V_Z$  AND TEMPERATURE (SINGLE SUPPLY)**



**ON/OFF-LEAKAGE CURRENT vs. TEMPERATURE**

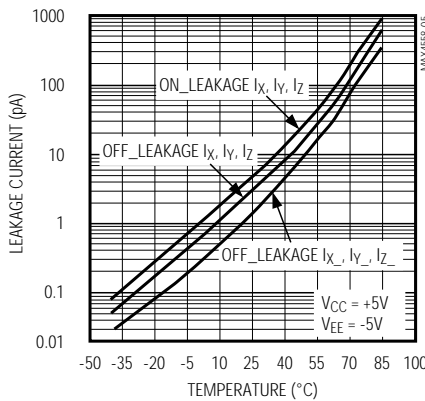

**CHARGE INJECTION vs.  $V_X, V_Y, V_Z$**



**POWER-SUPPLY CURRENT vs. TEMPERATURE**



**SCR HOLDING CURRENT vs. TEMPERATURE**

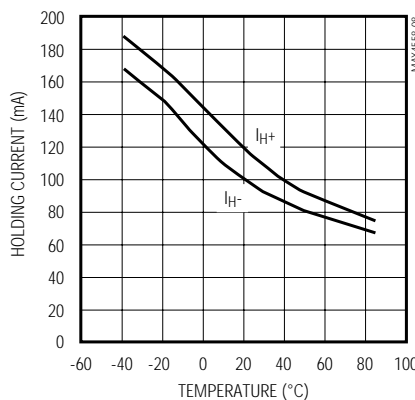

**TURN-ON/TURN-OFF TIME vs. SUPPLY VOLTAGE**



# ±15kV ESD-Protected, Low-Voltage, CMOS Analog Multiplexers/Switches

## Typical Operating Characteristics (continued)

(V<sub>CC</sub> = +5V, V<sub>EE</sub> = -5V, T<sub>A</sub> = +25°C, unless otherwise noted.)



## Pin Description

PIN			NAME	FUNCTION
MAX4558	MAX4559	MAX4560		
1, 2, 4, 5, 12-15	—	—	X0-X7	Analog Switch Inputs 0-7
3	—	—	X	Analog Switch Output
—	11, 12, 14, 15	—	X0, X1, X2, X3	Analog Switch "X" Inputs 0-3
—	13	14	X	Analog Switch "X" Output
—	—	13	X1	Analog Switch "X" Normally Open Input
—	—	12	X0	Analog Switch "X" Normally Closed Input
—	—	1	Y1	Analog Switch "C" Normally Open Input
—	—	2	Y0	Analog Switch "C" Normally Closed Input
6	6	6	ENABLE	Digital Enable Input. Connect to GND to enable device. Drive high to set all switches off.
7	7	7	V <sub>EE</sub>	Negative Analog Supply Voltage Input. Connect to GND for single-supply operation.
8	8	8	GND	Ground
11	10	11	A	Digital Address "A" Input
10	9	10	B	Digital Address "B" Input
9	—	9	C	Digital Address "C" Input
—	1, 2, 4, 5	—	Y0, Y1, Y2, Y3	Analog Switch "Y" Inputs 0-3
—	3	15	Y	Analog Switch "Y" Output
—	—	5	Z0	Analog Switch "Z" Normally Closed Input
—	—	3	Z1	Analog Switch "Z" Normally Open Input
—	—	4	Z	Analog Switch "Z" Output
16	16	16	V <sub>CC</sub>	Positive Analog and Digital Supply Voltage Input



# ±15kV ESD-Protected, Low-Voltage, CMOS Analog Multiplexers/Switches

## Detailed Description

The MAX4558/MAX4559/MAX4560 are ESD protected (per IEC 1000-4-2) at their X, Y, Z output pins and X<sub>-</sub>, Y<sub>-</sub>, Z<sub>-</sub> input pins. These ICs feature on-chip bidirectional silicon-controlled rectifiers (SCRs) between the protected pins and GND. The SCRs are normally off and have a negligible effect on the switches' performance. During an ESD strike, the voltages at the protected pins go Beyond-the-Rails™, causing the corresponding SCR(s) to turn on in a few nanoseconds. This bypasses the surge current safely to ground. This protection method is superior to using diode clamps to the supplies. Unless the supplies are very carefully decoupled through low-ESR capacitors, the ESD current through a diode clamp could cause a significant spike in the supplies, which might damage or compromise the reliability of any other chip powered by those same supplies.

In addition to the SCRs at the ESD-protected pins, these devices provide internal diodes connected to the supplies. Resistors placed in series with these diodes limit the current flowing into the supplies during an ESD strike. The diodes protect the X, Y, Z and X<sub>-</sub>, Y<sub>-</sub>, Z<sub>-</sub> pins from overvoltages due to improper power-supply sequencing.

Once the SCR turns on because of an ESD strike, it remains on until the current through it falls below its "holding current." The holding current is typically 110mA in the positive direction (current flowing into the pin) and 95mA in the negative direction at room temperature (see SCR Holding Current vs. Temperature in the *Typical Operating Characteristics*). The system should be designed so that any sources connected to

the X, Y, Z or X<sub>-</sub>, Y<sub>-</sub>, Z<sub>-</sub> pins are current limited to a value below the holding current. This ensures that the SCR turns off and normal operation resumes after an ESD event.

Keep in mind that the holding currents vary significantly with temperature; they drop to 70mA (typ) in the positive direction and 65mA (typ) in the negative direction, at +85°C worst case. To guarantee turn-off of the SCRs under all conditions, current limit the sources connected to these pins to not more than half of these typical values. When the SCR is latched, the voltage across it is about ±3V, depending on the polarity of the pin current. The supply voltages do not affect the holding currents appreciably. When one or more SCRs turn on because of an ESD event, all switches in the part turn off to prevent current through the switch(es) from sustaining latchup.

Even though most of the ESD current flows to GND through the SCRs, a small portion of it goes into the supplies. Therefore, it is a good idea to bypass the supply pins with 100nF capacitors to the ground plane.

## Applications Information

### ESD Protection

The MAX4558/MAX4559/MAX4560 are characterized for protection to the following:

- ±15kV using the Human Body Model
- ±8kV using the Contact Discharge method specified in IEC 1000-4-2 (formerly IEC 801-2)
- ±12kV using the Air-Gap Discharge method specified in IEC 1000-4-2 (formerly IEC 801-2).

*Beyond-the-Rails is a trademark of Maxim Integrated Products.*

**Table 1. Truth Table/Switch Programming**

ENABLE INPUT	SELECT INPUTS			ON SWITCHES		
	C*	B	A	MAX4558	MAX4559	MAX4560
H	X	X	X	All switches open	All switches open	All switches open
L	L	L	L	X-X0	X-X0, Y-Y0	X-X0, Y-Y0, Z-Z0
L	L	L	H	X-X1	X-X1, Y-Y1	X-X1, Y-Y0, Z-Z0
L	L	H	L	X-X2	X-X2, Y-Y2	X-X0, Y-Y1, Z-Z0
L	L	H	H	X-X3	X-X3, Y-Y3	X-X1, Y-Y1, Z-Z0
L	H	L	L	X-X4	X-X0, Y-Y0	X-X0, Y-Y0, Z-Z1
L	H	L	H	X-X5	X-X1, Y-Y1	X-X1, Y-Y0, Z-Z1
L	H	H	L	X-X6	X-X2, Y-Y2	X-X0, Y-Y1, Z-Z1
L	H	H	H	X-X7	X-X3, Y-Y3	X-X1, Y-Y1, Z-Z1

X = Don't care \* C not present on MAX4559.

**Note:** Input and output pins are identical and interchangeable. Either may be considered an input or output; signals pass equally well in either direction.

# $\pm 15\text{kV}$ ESD-Protected, Low-Voltage, CMOS Analog Multiplexers/Switches

## *ESD Test Conditions*

ESD performance depends on several conditions. Contact Maxim for a reliability report that documents test setup, methodology, and results.

## *Human Body Model*

Figure 6 shows the Human Body Model, and Figure 7 shows the current waveform it generates when discharged into a low impedance. This model consists of a 100pF capacitor charged to the ESD voltage of interest, which is then discharged into the test device through a 1.5k $\Omega$  resistor.

## *Power-Supply Considerations*

The MAX4558/MAX4559/MAX4560 are typical of most CMOS analog switches. They have three supply pins: VCC, VEE, and GND. VCC and VEE drive the internal CMOS switches and set the limits of the analog voltage on every switch. Internal reverse ESD-protection diodes connect between each analog signal pin and both VCC and VEE. If any analog signal exceeds VCC or VEE, one of these diodes conducts. The only currents drawn from VCC or VEE during normal operation are the leakage currents of these ESD diodes.

Although the ESD diodes on a given signal pin are identical and therefore fairly well balanced, they are reverse biased differently. Each is biased by either VCC or VEE and the analog signal. Their leakage currents vary as the signal varies. The difference in the two diode leakages to the VCC and VEE pins constitutes the analog signal-path leakage current. All analog leakage current flows between each input and one of the supply

terminals, not to the other switch terminal. This is why both sides of a given switch can show leakage currents of either the same or opposite polarity.

VCC and GND power the internal logic and logic-level translators, and set the input logic limits. The logic-level translators convert the logic levels into switched VCC and VEE signals to drive the gates of the analog switch. This drive signal is the only connection between the logic supplies and logic signals and the analog supplies. VCC and VEE have ESD-protection diodes to GND.

The logic-level thresholds are TTL/CMOS compatible when VCC is +5V. As VCC rises, the threshold increases slightly. When VCC reaches +12V, the threshold is about 3.1V (above the TTL-guaranteed high-level minimum of 2.4V, but still compatible with CMOS outputs).

## *High-Frequency Performance*

In 50 $\Omega$  systems, signal response is reasonably flat up to 50MHz (see *Typical Operating Characteristics*). Above 20MHz, the on response has several minor peaks that are highly layout dependent. The problem is not turning the switch on, but turning it off. The off-state switch acts like a capacitor and passes higher frequencies with less attenuation. At 1MHz, off-isolation is about -68dB in 50 $\Omega$  systems, becoming worse (approximately 20dB per decade) as the frequency increases. Higher circuit impedance also degrades off-isolation. Adjacent channel attenuation is about 3dB above that of a bare IC socket and is entirely due to capacitive coupling.

# ±15kV ESD-Protected, Low-Voltage, CMOS Analog Multiplexers/Switches

## Test Circuits/Timing Diagrams

MAX4558/MAX4559/MAX4560

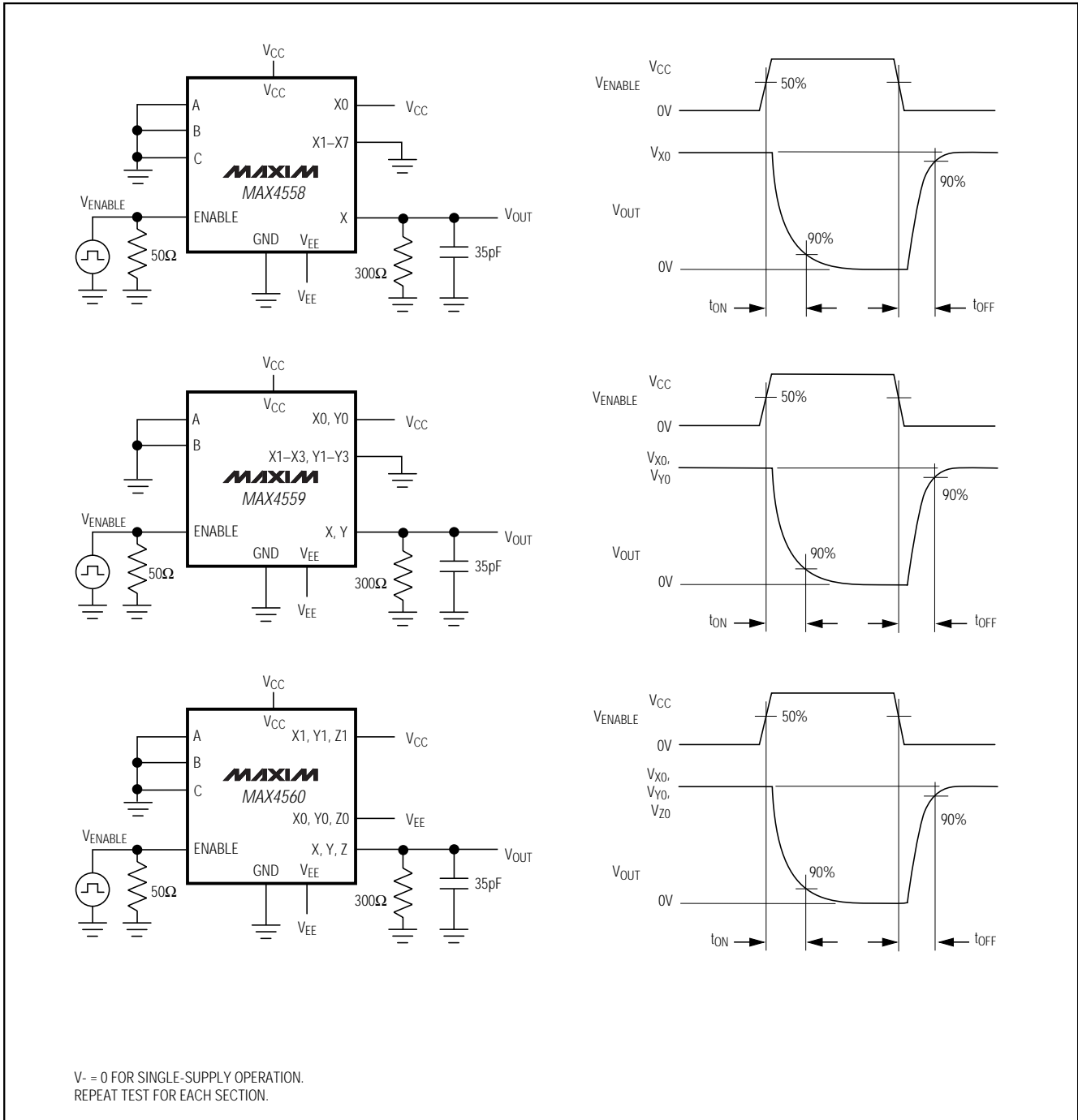

Figure 1. Switching Times

# ±15kV ESD-Protected, Low-Voltage, CMOS Analog Multiplexers/Switches

Test Circuits/Timing Diagrams (continued)



Figure 2. Break-Before-Make Interval



Figure 3. Charge Injection

# ±15kV ESD-Protected, Low-Voltage, CMOS Analog Multiplexers/Switches

Test Circuits/Timing Diagrams (continued)

MAX4558/MAX4559/MAX4560

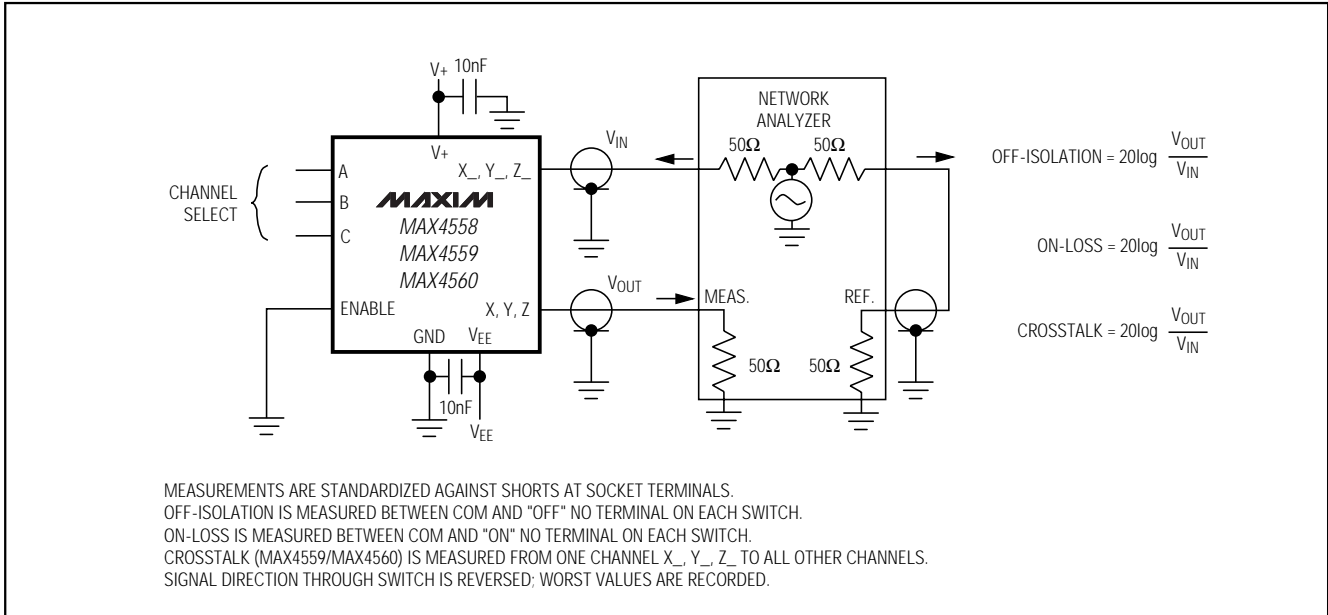

Figure 4. Off-Isolation/On-Channel Bandwidth and Crosstalk



Figure 5. Channel Off/On-Capacitance

# ±15kV ESD-Protected, Low-Voltage, CMOS Analog Multiplexers/Switches

## Test Circuits/Timing Diagrams (continued)



Figure 6. Human Body ESD Test Model

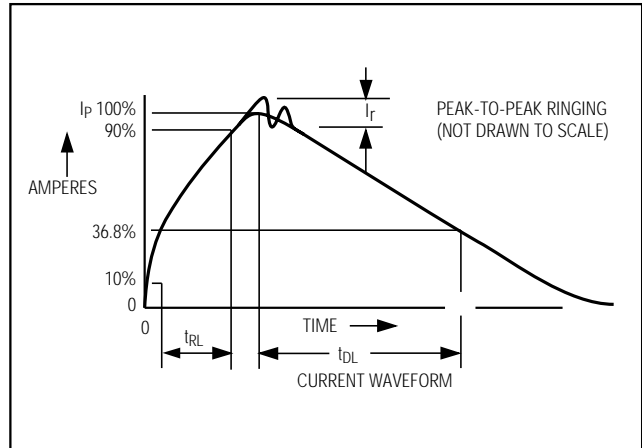

Figure 7. Human Body Model Current Waveform

## Ordering Information (continued)

PART	TEMP. RANGE	PIN-PACKAGE
MAX4558EEE	-40°C to +85°C	16 QSOP
MAX4558ESE	-40°C to +85°C	16 Narrow SO
MAX4558EPE	-40°C to +85°C	16 Plastic DIP
<b>MAX4559</b> CEE	0°C to +70°C	16 QSOP
MAX4559CSE	0°C to +70°C	16 Narrow SO
MAX4559CPE	0°C to +70°C	16 Plastic DIP
MAX4559EEE	-40°C to +85°C	16 QSOP
MAX4559ESE	-40°C to +85°C	16 Narrow SO
MAX4559EPE	-40°C to +85°C	16 Plastic DIP
<b>MAX4560</b> CEE	0°C to +70°C	16 QSOP
MAX4560CSE	0°C to +70°C	16 Narrow SO
MAX4560CPE	0°C to +70°C	16 Plastic DIP
MAX4560EEE	-40°C to +85°C	16 QSOP
MAX4560ESE	-40°C to +85°C	16 Narrow SO
MAX4560EPE	-40°C to +85°C	16 Plastic DIP

## Chip Information

TRANSISTOR COUNT: 221

# ±15kV ESD-Protected, Low-Voltage, CMOS Analog Multiplexers/Switches

## Package Information

MAX4558/MAX4559/MAX4560

QSOP-EPS



DIM	INCHES		MILLIMETERS	
	MIN	MAX	MIN	MAX
A	.061	.068	1.55	1.73
A1	.004	.0098	0.102	0.249
A2	.055	.061	1.40	1.55
B	.008	.012	0.20	0.31
C	.0075	.0098	0.191	0.249
D	SEE VARIATIONS			
E	.150	.157	3.81	3.99
e	.025 BSC		0.635 BSC	
H	.230	.244	5.84	6.20
h	.010	.016	0.25	0.41
L	.016	.035	0.41	0.89
N	SEE VARIATIONS			
X	SEE VARIATIONS			
Y	.071	.087	1.803	2.209
α	0°	8°	0°	8°

### VARIATIONS:

DIM	INCHES		MILLIMETERS		N
	MIN.	MAX.	MIN.	MAX.	
D	.189	.196	4.80	4.98	16  AA
S	.0020	.0070	0.05	0.18	
X	.107	.123	2.72	3.12	
D	.337	.344	8.56	8.74	20  AB
S	.0500	.0550	1.270	1.397	
D	.337	.344	8.56	8.74	24  AC
S	.0250	.0300	0.635	0.762	
D	.386	.393	9.80	9.98	28  AD
S	.0250	.0300	0.635	0.762	
X	.271	.287	6.88	7.29	

### NOTES:

1. D & E DO NOT INCLUDE MOLD FLASH OR PROTRUSIONS
2. MOLD FLASH OR PROTRUSIONS NOT TO EXCEED .006" PER SIDE.
3. HEAT SLUG DIMENSIONS X AND Y APPLY ONLY TO 16 AND 28 LEAD POWER-QSOP PACKAGES.
4. CONTROLLING DIMENSIONS: INCHES.

<b>MAXIM</b>		
PROPRIETARY INFORMATION		
TITLE:		
PACKAGE OUTLINE, QSOP, 150°, .025" LEAD PITCH		
APPROVAL	DOCUMENT CONTROL NO.	REV
	21-0055	B 1/1

# ±15kV ESD-Protected, Low-Voltage, CMOS Analog Multiplexers/Switches

Package Information (continued)

INCHES				MILLIMETERS			
	MIN	MAX		MIN	MAX		
A	0.053	0.069	1.35	1.75			
A1	0.004	0.010	0.10	0.25			
B	0.014	0.019	0.35	0.49			
C	0.007	0.010	0.19	0.25			
e	0.050		1.27				
E	0.150	0.157	3.80	4.00			
H	0.228	0.244	5.80	6.20			
h	0.010	0.020	0.25	0.50			
L	0.016	0.050	0.40	1.27			

INCHES				MILLIMETERS			
	MIN	MAX		MIN	MAX	N	MS012
D	0.189	0.197	4.80	5.00	8	A	
D	0.337	0.344	8.55	8.75	14	B	
D	0.386	0.394	9.80	10.00	16	C	

NOTES:  
 1. D&E DO NOT INCLUDE MOLD FLASH  
 2. MOLD FLASH OR PROTRUSIONS NOT TO EXCEED .15mm (.006")  
 3. LEADS TO BE COPLANAR WITHIN .102mm (.004")  
 4. CONTROLLING DIMENSION: MILLIMETER  
 5. MEETS JEDEC MS012-XX AS SHOWN IN ABOVE TABLE  
 6. N = NUMBER OF PINS

MAXIM PACKAGE FAMILY OUTLINE: SOIC .150° 21-0041 A

INCHES				MILLIMETERS			
	MIN	MAX		MIN	MAX		
A	---	0.200	---	5.08			
A1	0.015	---	0.38	---			
A2	0.125	0.175	3.18	4.45			
A3	0.055	0.080	1.40	2.03			
B	0.016	0.022	0.41	0.56			
B1	0.045	0.065	1.14	1.65			
C	0.008	0.012	0.20	0.30			
D1	0.005	0.080	0.13	2.03			
E	0.300	0.325	7.62	8.26			
E1	0.240	0.310	6.10	7.87			
e	0.100	---	2.54	---			
eA	0.300	---	7.62	---			
eB	---	0.400	---	10.16			
L	0.115	0.150	2.92	3.81			

INCHES				MILLIMETERS			
	MIN	MAX		MIN	MAX	N	MS001
D	0.348	0.390	8.84	9.91	8	AB	
D	0.735	0.765	18.67	19.43	14	AC	
D	0.745	0.765	18.92	19.43	16	AA	
D	0.885	0.915	22.48	23.24	18	AD	
D	1.015	1.045	25.78	26.54	20	AE	
D	1.14	1.265	28.96	32.13	24	AF	
D	1.360	1.380	34.54	35.05	28	*5	

NOTES:  
 1. D&E DO NOT INCLUDE MOLD FLASH  
 2. MOLD FLASH OR PROTRUSIONS NOT TO EXCEED .15mm (.006")  
 3. CONTROLLING DIMENSION: MILLIMETER  
 4. MEETS JEDEC MS001-XX AS SHOWN IN ABOVE TABLE  
 5. SIMILAR TO JEDEC MD-058AB  
 6. N = NUMBER OF PINS

MAXIM PACKAGE FAMILY OUTLINE: PDIP .300° 21-0043 A

Maxim cannot assume responsibility for use of any circuitry other than circuitry entirely embodied in a Maxim product. No circuit patent licenses are implied. Maxim reserves the right to change the circuitry and specifications without notice at any time.

16 Maxim Integrated Products, 120 San Gabriel Drive, Sunnyvale, CA 94086 408-737-7600



## X-ON Electronics

Largest Supplier of Electrical and Electronic Components

*Click to view similar products for [Multiplexer Switch ICs](#) category:*

*Click to view products by [Maxim](#) manufacturer:*

Other Similar products are found below :

[NLV74HC4066ADR2G](#) [HEF4051BP](#) [MC74HC4067ADTG](#) [DG508AAK/883B](#) [NLV14051BDG](#) [016400E](#) [PI3V512QE](#) [7705201EC](#)  
[PI2SSD3212NCE](#) [PI3L100QE](#) [NLAS3257CMX2TCG](#) [PI5A3157BC6EX](#) [PI3V512QEX](#) [PI3DBS16213ZLEX](#) [PI3DBS16415ZHEX](#)  
[PS509LEX](#) [MUX36S16IRSNR](#) [74LVC1G3157GM-Q10X](#) [TC7W53FK,LF](#) [CD4053BM96](#) [MC74HC4053ADWR2G](#) [MAX4051AEEE+](#)  
[HEF4053BT.653](#) [PI3L720ZHEX](#) [ADG1404YRUZ-REEL7](#) [ADG1208YRZ-REEL7](#) [MAX4704EUB+T](#) [ADG1406BRUZ-REEL7](#)  
[CD4053BPWRG4](#) [ADG658TRUZ-EP](#) [74HC4053D.653](#) [74HCT4052PW.118](#) [74LVC2G53DP.125](#) [74HC4052DB.112](#) [74HC4052PW.112](#)  
[74HC4053DB.112](#) [74HC4067DB.112](#) [74HC4351DB.112](#) [74HCT4052D.112](#) [74HCT4052DB.112](#) [74HCT4351D.112](#) [74LV4051PW.112](#)  
[FSA1256L8X\\_F113](#) [PI5V330QE](#) [PI5V331QE](#) [5962-8771601EA](#) [5962-87716022A](#) [ADG5249FBRUZ](#) [ADG1438BRUZ](#) [ADG5207BCPZ-](#)  
[RL7](#)