



MAX4940 Evaluation Kit/Master Board

General Description

The MAX4940 evaluation kit (EV kit) provides a proven design to evaluate the MAX4940 quad, high-voltage pulse driver. The MAX4940 EV kit can be driven by the MAX4940 Master Board, a signal generator based on the Altera EPM1270F256C5N MAX II CPLD.

The MAX4940 EV kit comes with a MAX4940CTN+ installed. Contact the factory for free samples of the pin-compatible MAX4940ACTN+ to evaluate this device.

For complete evaluation, including test waveform generation, order the MAX4940MB+ together with the MAX4940EVKIT+.

Features

- ◆ 3.5mm Scope Probe Jacks
- ◆ Proven PCB Layout
- ◆ Fully Assembled and Tested
- ◆ Stand-Alone Waveform Generation (MAX4940MB+)

Ordering Information

PART	TYPE
MAX4940EVKIT+	EV Kit
MAX4940MB+	Master Board (signal generator)

+Denotes lead(Pb)-free and RoHS compliant.

Component Lists

MAX4940 EV Kit

DESIGNATION	QTY	DESCRIPTION
COUT1–COUT4	4	220pF ±10%, 100V X7R ceramic capacitors (0402) Murata GRM155R72A221K
C1–C8	8	3300pF ±10%, 100V X7R ceramic capacitors (0402) Murata GRM155R72A332K
C9–C15	7	0.1µF ±10%, 100V X7R ceramic capacitors (0603) Murata GRM188R72A104K
C16–C19	4	0.1µF ±10%, 16V X7R ceramic capacitors (0402) Murata GRM155R71C104K
C20, C21, C22	3	10µF ±10%, 25V X7R ceramic capacitors (1206) Murata GRM31CR71E106K
C23–C26	4	10µF ±20%, 160V aluminum electrolytic capacitors (G13) Panasonic EEV-EB2C100Q

DESIGNATION	QTY	DESCRIPTION
H1	1	Dual-row, right-angle header (2 x 8)
HOUT1A, HOUT1B, HOUT2A, HOUT2B, JU1– JU13	17	2-pin headers
ROUT1–ROUT4	4	1kΩ ±5%, 1W resistors (2512) Panasonic ERJ-1TYJ102U
T1A, T1B, T2A, T2B	4	Scope probe jacks, 3.5mm
U1	1	Quad high-voltage pulse driver (56 TQFN-EP*) Maxim MAX4940CTN+
—	11	Shunts
—	1	PCB: MAX4940 EVALUATION KIT+

*EP = Exposed pad.

Evaluate: MAX4940/MAX4940A

MAX4940 Evaluation Kit/Master Board

Component Lists (continued)

MAX4940 Master Board

DESIGNATION	QTY	DESCRIPTION
C8	1	560pF ±5%, 50V C0G ceramic capacitor (0603) TDK C1608C0G1H561J
C14	1	4.7µF ±10%, 6.3V X5R ceramic capacitor (0603) TDK C1608X5R0J475K
C15, C26, C27, C34, C35, CSW1–CSW7	12	0.01µF ±10%, 50V X7R ceramic capacitors (0603) TDK C1608X7R1H103K
C25, C31, C32, C33, C36–C39, C55–C59	13	0.1µF ±10%, 50V X7R ceramic capacitors (0603) TDK C1608X7R1H104K
C69	1	10pF ±5%, 50V C0G ceramic capacitor (0603) TDK C1608C0G1H100J
C201, C202	2	1µF ±10%, 10V X7R ceramic capacitors (0603) TDK C1608X7R1A105K
FB1	1	Ferrite bead (0603) TDK MMZ1608R301A
H1	1	Dual-row, right-angle header (2 x 8)
J2	1	10-pin header (2 x 5)

DESIGNATION	QTY	DESCRIPTION
JU1	0	Not installed, 2-pin header
LED0–LED16	17	Red LEDs (0805)
RLED0–RLED16	17	200Ω ±5% resistors (0603)
R13	1	1kΩ ±5% resistor (0603)
R14, R16, R19, R20, RSW1–RSW7	11	10kΩ ±5% resistors (0603)
R15	0	Not installed, resistor (0603)
R17	1	33Ω ±5% resistor (0603)
SW1–SW7	7	Momentary pushbutton switches, normally open
TP0–TP4	0	Not installed, multipurpose test points
U1	1	CPLD, 1270 logic elements (256 FBGA) Altera EPM1270F256C5N
U2	1	3.3V, 1000mA LDO regulator (16 TSSOP-EP*) Maxim MAX8869EUE33+
Y1	1	66MHz crystal oscillator (7.5mm x 5mm)
—	1	PCB: MAX4940 MASTER BOARD+

*EP = Exposed pad.

Component Suppliers

SUPPLIER	PHONE	WEBSITE
Altera Corp.	800-800-3753	www.altera.com
Murata Electronics North America, Inc.	770-436-1300	www.murata-northamerica.com
Panasonic Corp.	800-344-2112	www.panasonic.com
TDK Corp.	847-803-6100	www.component.tdk.com

Note: Indicate that you are using the MAX4940 when contacting these component suppliers.

MAX4940 Evaluation Kit/Master Board

Evaluate: MAX4940/MAX4940A

Quick Start

Required Equipment

- MAX4940 EV kit
- MAX4940 Master Board (or equivalent signal generator)
- +5V DC power supply
- $\pm 12V$ DC dual-tracking power supplies
- $\pm 100V$ DC at 20mA high-voltage, dual-tracking power supplies
- Recommended: Oscilloscope to view high-voltage outputs

Procedure

The MAX4940 EV kit is fully assembled and tested. Follow the steps below to verify board operation:

- 1) Verify that the jumpers are in their default positions, as shown in Table 1 with one exception (JU1 must be open).
- 2) Connect the MAX4940 EV kit to the MAX4940 Master Board signal generator.
- 3) Connect an oscilloscope probe to T1A on the MAX4940 EV kit.
- 4) Connect all power-supply ground returns to GND.
- 5) Connect the +5V DC power supply to the IN +5V pad on the MAX4940 Master Board. This powers the on-board MAX8869 +3.3V linear regulator, which drives the CPLD and the MAX4940's VDD supply.
- 6) Connect the +12V DC power supply to VCC on the MAX4940 EV kit.
- 7) Connect the -12V DC power supply to VEE on the MAX4940 EV kit.
- 8) Connect the +100V DC power supply to VPP1 on the MAX4940 EV kit.
- 9) Connect the -100V DC power supply to VNN1 on the MAX4940 EV kit.
- 10) Enable the +5V DC power supply.
- 11) Enable the $\pm 12V$ DC power supplies.
- 12) Enable the $\pm 100V$ DC power supplies.
- 13) Set the MAX4940 Master Board to generate waveform A by pressing SW2 until LED2 is lit.
- 14) Verify that the oscilloscope shows expected high-voltage outputs from waveform A (OUT1A).
- 15) Set the MAX4940 Master Board to generate waveform B by pressing SW2 until LED3 is lit.
- 16) Verify that the oscilloscope shows expected high-voltage outputs from waveform B (OUT1A).
- 17) Set the MAX4940 Master Board to generate waveform C by pressing SW2 until LED4 is lit.
- 18) Verify that the oscilloscope shows expected high-voltage outputs from waveform C (OUT1A).
- 19) Set the MAX4940 Master Board to generate waveform D by pressing SW2 until LED5 is lit.
- 20) Verify that the oscilloscope shows expected high-voltage outputs from waveform D (OUT1A).
- 21) Reduce the VPP/VNN supplies to $\pm 5V$ DC.
- 22) Set the MAX4940 Master Board to generate waveform E by pressing SW2 until LED6 is lit.
- 23) Verify that the oscilloscope shows expected outputs from waveform E (OUT1A).
- 24) Repeat steps 13–23 to view waveforms OUT1B, OUT2A, and OUT2B.

Evaluate: MAX4940/MAX4940A

MAX4940 Evaluation Kit/Master Board

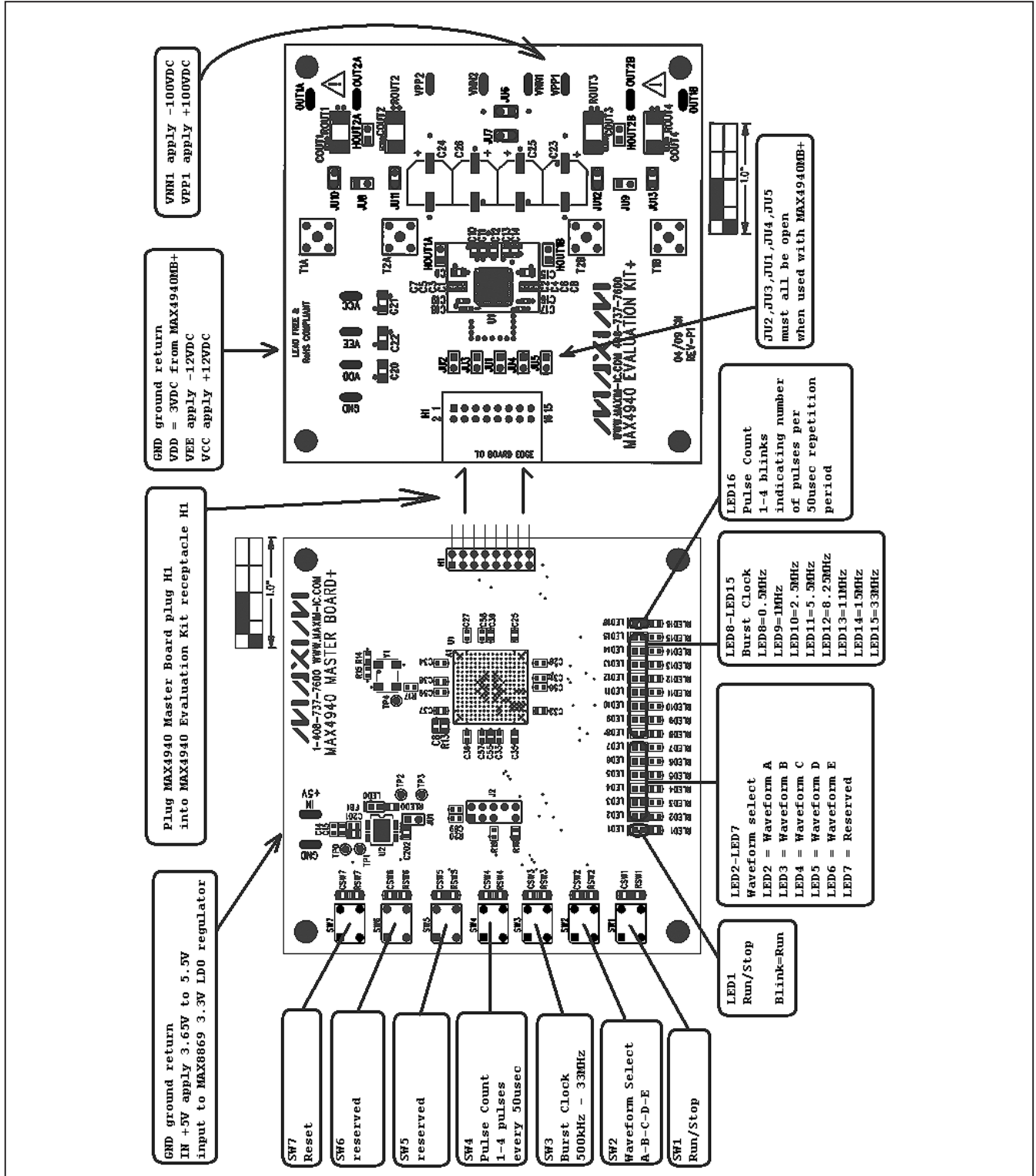

Figure 1. MAX4940 EV Kit System Operation Guide

MAX4940 Evaluation Kit/Master Board

Evaluate: MAX4940/MAX4940A

Detailed Description of Hardware

MAX4940 EV Kit

The MAX4940 EV kit provides a proven layout for the MAX4940. Capacitors C1–C8 are the “flying caps” for

the MAX4940’s internal charge pump. Jumpers JU1–JU5 are used to drive EN and the clamp inputs when the EV kit board is used without the master board. On-board dummy-load circuits are enabled by jumpers JU10–JU13.

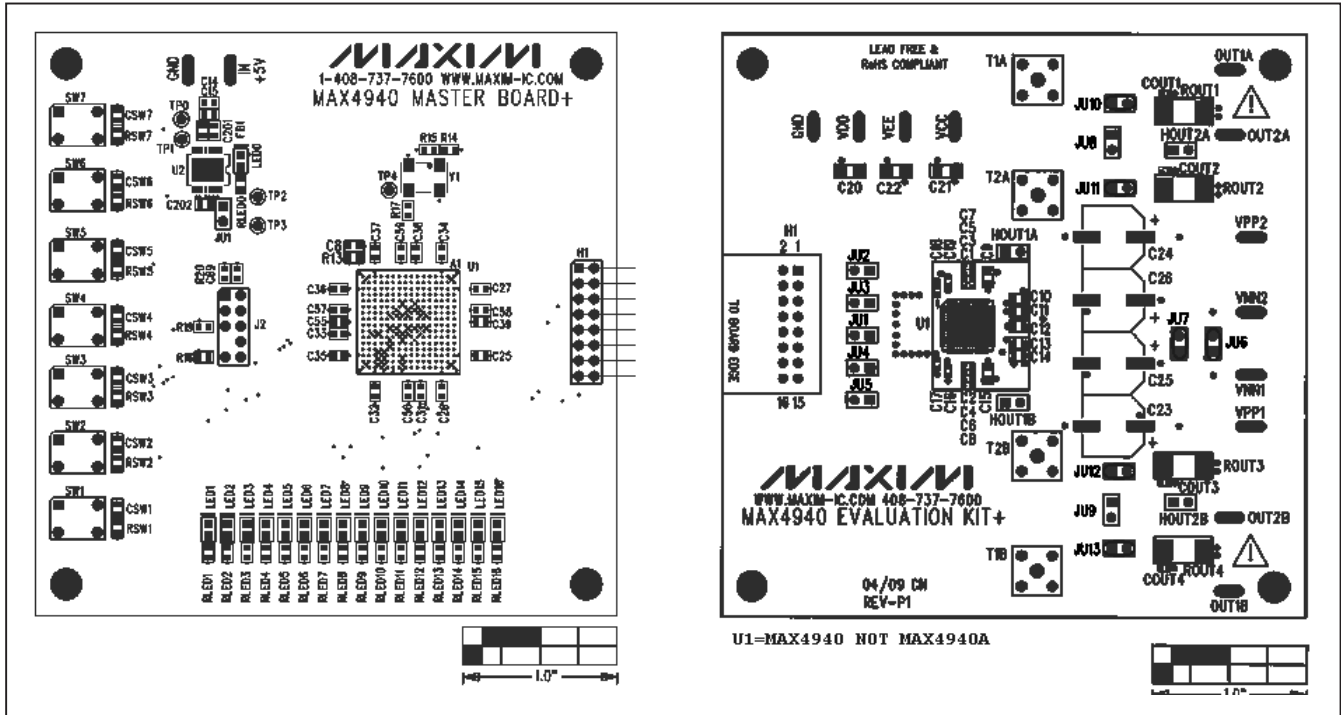

Figure 2. MAX4940 Jumper Guide

Table 1. MAX4940 EV Kit Jumper Descriptions (JU1–JU13)

JUMPER	SIGNAL	SHUNT POSITION	DESCRIPTION
JU1	EN	1-2*	Enable input EN connects to VDD, enabling the high-voltage outputs for normal operation
		Open	Enable input EN is not connected to VDD (required when driven with MAX4940 Master Board, or other external signal source)
JU2	CLP1A	1-2	Clamp input CLP1A connects to VDD, enabling the always-on active clamp feature (MAX4940 only)
		Open*	CLP1A is not connected to VDD (required when driven with MAX4940 Master Board, or other external signal source)
JU3	CLP2A	1-2	Clamp input CLP2A connects to VDD, enabling the always-on active clamp feature (MAX4940 only)
		Open*	CLP2A is not connected to VDD (required when driven with MAX4940 Master Board, or other external signal source)

MAX4940 Evaluation Kit/Master Board

Table 1. MAX4940 EV Kit Jumper Descriptions (JU1–JU13) (continued)

JUMPER	SIGNAL	SHUNT POSITION	DESCRIPTION
JU4	CLP2B	1-2	Clamp input CLP2B connects to VDD, enabling the always-on active clamp feature (MAX4940 only)
		Open*	CLP2B is not connected to VDD (required when driven with MAX4940 Master Board, or other external signal source)
JU5	CLP1B	1-2	Clamp input CLP1B connects to VDD, enabling the always-on active clamp feature (MAX4940 only).
		Open*	CLP1B is not connected to VDD (required when driven with MAX4940 Master Board, or other external signal source)
JU6	VNN1, VNN2	1-2*	VNN1 and VNN2 are connected together (required when U1 = MAX4940)
JU7	VPP1, VPP2	1-2*	VPP1 and VPP2 are connected together (required when U1 = MAX4940)
JU8	OUT1A, OUT2A	Open*	OUT1A and OUT2A are independent (required when U1 = MAX4940)
JU9	OUT1B, OUT2B	Open*	OUT1B and OUT2B are independent (required when U1 = MAX4940)
JU10	Load-1A	1-2*	Dummy load ROUT1/COUT1 connects to OUT1A
		Open	Dummy load ROUT1/COUT1 is disconnected
JU11	Load-2A	1-2*	Dummy load ROUT2/COUT2 connects to OUT2A
		Open	Dummy load ROUT2/COUT2 is disconnected
JU12	Load-2B	1-2*	Dummy load ROUT3/COUT3 connects to OUT2B
		Open	Dummy load ROUT3/COUT3 is disconnected
JU13	Load-1B	1-2*	Dummy load ROUT4/COUT4 connects to OUT1B
		Open	Dummy load ROUT4/COUT4 is disconnected

*Default position.

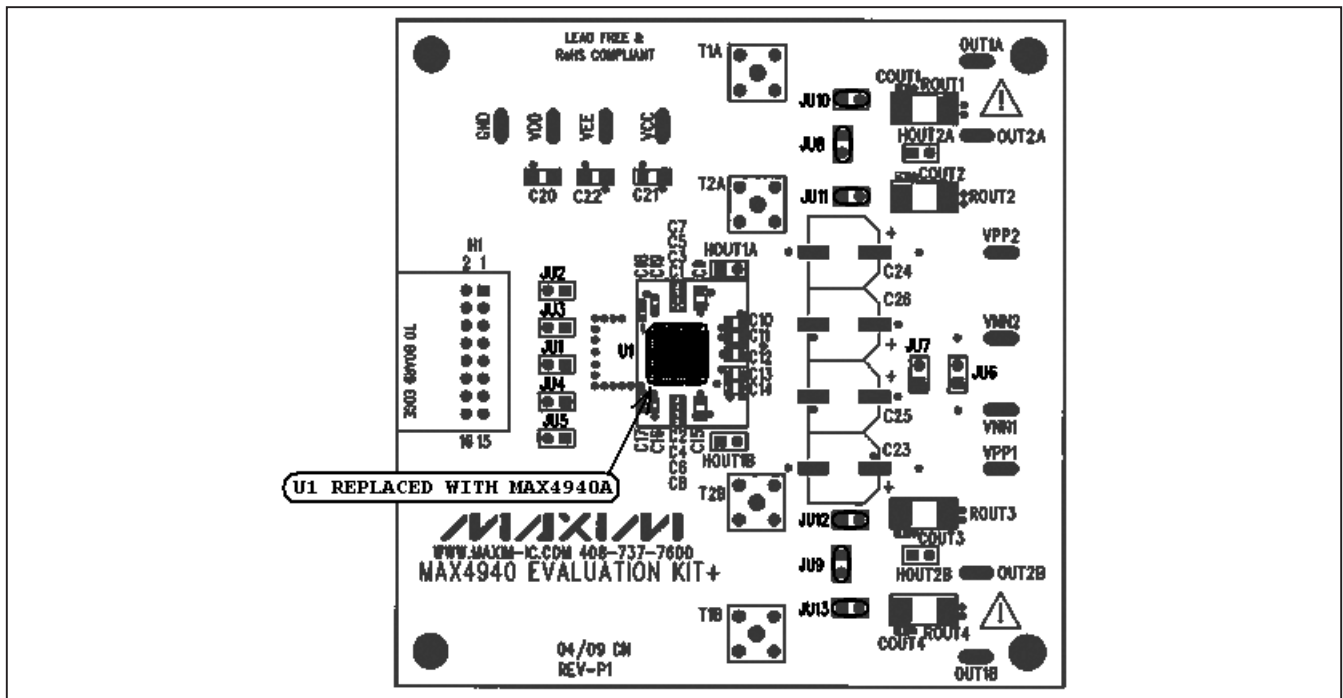

Figure 3. MAX4940A Jumper Guide

MAX4940 Evaluation Kit/Master Board

MAX4940 Master Board

The EPM1270F256C5N (U1) is from Altera's MAX II family of CPLDs. Contact Altera for any questions regarding the CPLD. See the *Component Suppliers* table for contact information.

The MAX8869 (U2) is a high-current, low-dropout (LDO) linear regulator, preset to 3V output. This regulator supplies the CPLD and the MAX4940 EV kit VDD supply.

Pushbutton Switch Operation

The MAX4940 Master Board firmware is controlled by pushbutton switches SW1–SW7. SW1 toggles between run and stop mode. Pressing and releasing SW2 selects the waveform. Pressing and releasing SW3 selects the burst frequency. SW4 selects the number of times to repeat the waveform. Pressing SW7 resets the MAX4940 Master Board configuration to run waveform A at the fastest burst clock, one pulse every 50µs.

Every 50µs the MAX4940 Master Board self-triggers the selected waveform. The waveform data is determined by

SW2. The burst frequency is determined by SW3, and the number of times the waveform repeats is determined by SW4. Waveform E automatically activates continuous-wave mode, repeating the waveform continuously. For waveform E, the enable output EN is driven with a 10% duty-cycle signal with approximately a 100ms period.

The use of an oscilloscope is recommended to confirm that the correct operation mode is selected.

Evaluating the MAX4940A

With power disconnected, replace U1 with the MAX4940A IC. Configure the jumpers according to Table 2. Jumpers JU2–JU7 must be open. Move the shunts from JU6 and JU7 to JU8 and JU9. Follow the steps in the *Quick Start* section except a signal source must be used in place of the master board. In addition, use two separate power supplies for VPP1/VNN1 and VPP2/VNN2. Refer to the MAX4940A IC data sheet for more information.

Table 2. MAX4940A Jumper Descriptions (JU1–JU13)

JUMPER	SIGNAL	SHUNT POSITION	DESCRIPTION
JU1	EN	1-2*	Enable input EN connects to VDD, enabling the high-voltage outputs for normal operation
		Open	Enable input EN is not connected to VDD (required when driven with MAX4940 Master Board, or other external signal source)
JU2	CLP1A	Open*	CLP1A is not connected to VDD (required when U1 = MAX4940A)
JU3	CLP2A	Open*	CLP2A is not connected to VDD (required when U1 = MAX4940A)
JU4	CLP2B	Open*	CLP2B is not connected to VDD (required when U1 = MAX4940A)
JU5	CLP1B	Open*	CLP1B is not connected to VDD (required when U1 = MAX4940A)
JU6	VNN1, VNN2	Open	VNN1 and VNN2 are independent (required when U1 = MAX4940A)
JU7	VPP1, VPP2	Open	VPP1 and VPP2 are independent (required when U1 = MAX4940A)
JU8	OUT1A, OUT2A	1-2	OUT1A and OUT2A are connected together (required when U1 = MAX4940A)
JU9	OUT1B, OUT2B	1-2	OUT1B and OUT2B are connected together (required when U1 = MAX4940A)
JU10	Load-1A	1-2*	Dummy load ROUT1/COU1 connects to OUT1A
		Open	Dummy load ROUT1/COU1 is disconnected
JU11	Load-2A	1-2*	Dummy load ROUT2/COU2 and in connects to OUT2A
		Open	Dummy load ROUT2/COU2 is disconnected
JU12	Load-2B	1-2*	Dummy load ROUT3/COU3 connects to OUT2B
		Open	Dummy load ROUT3/COU3 is disconnected
JU13	Load-1B	1-2*	Dummy load ROUT4/COU4 connects to OUT1B
		Open	Dummy load ROUT4/COU4 is disconnected

*Default position.

Evaluate: MAX4940/MAX4940A

MAX4940 Evaluation Kit/Master Board

Evaluate: MAX4940/MAX4940A

Table 3. MAX4940 Master Board Control Table

SIGNAL	SWITCH	LED	STATE	MEANING
Run/Stop	SW1	LED1	Blinking	Run mode
			On	Stop mode
Waveform	SW2	LED2	On	Waveform A (see Figure 4)
		LED3	On	Waveform B (see Figure 5)
		LED4	On	Waveform C (see Figure 6)
		LED5	On	Waveform D (see Figure 7)
		LED6	On	Waveform E (see Figure 8)
		LED7	On	Reserved
Burst clock timebase	SW3	LED8	On	0.5MHz
		LED9	On	1MHz
		LED10	On	2.53MHz
		LED11	On	5.5MHz
		LED12	On	8.25MHz
		LED13	On	11MHz
		LED14	On	15MHz
Pulse repeat	SW4	LED16	Flashes 1 time	1 pulse every 50µs
			Flashes 2 times	2 pulses every 50µs
			Flashes 3 times	3 pulses every 50µs
			Flashes 4 times	4 pulses every 50µs

Table 4. SW1 Run/Stop Functions

FUNCTION	INDICATOR
Run mode	LED1 blinking
Stop mode	LED1 on

Note: Each time SW1 is pressed and released, the next function is selected.

Table 5. SW2 Waveform Functions

FUNCTION	INDICATOR	REMARKS
Waveform A	LED2	NRZ pulses with EN, INP first (see Figure 4)
Waveform B	LED3	NRZ pulses with EN, INN first (see Figure 5)
Waveform C	LED4	RZ pulses with clamp, INP first (see Figure 6)
Waveform D	LED5	RZ pulses with clamp, INN first (see Figure 7)
Waveform E	LED6	CW pulses (see Figure 8)
Reserved	LED7	Reserved

Note: Each time SW2 is pressed and released, the next function is selected.

Table 6. SW3 Burst Clock Functions

FUNCTION (MHz)	INDICATOR
0.5	LED8
1	LED9
2.53	LED10
5.5	LED11
8.25	LED12
11	LED13
15	LED14
33	LED15

Note: Each time SW3 is pressed and released, the next function is selected.

Table 7. SW4 Functions

FUNCTION	INDICATOR
1 pulse every 50µs	LED16 flashes 1 time
2 pulses every 50µs	LED16 flashes 2 times
3 pulses every 50µs	LED16 flashes 3 times
4 pulses every 50µs	LED16 flashes 4 times

Note: Each time SW4 is pressed and released, the next function is selected.

MAX4940 Evaluation Kit/Master Board

Evaluate: MAX4940/MAX4940A

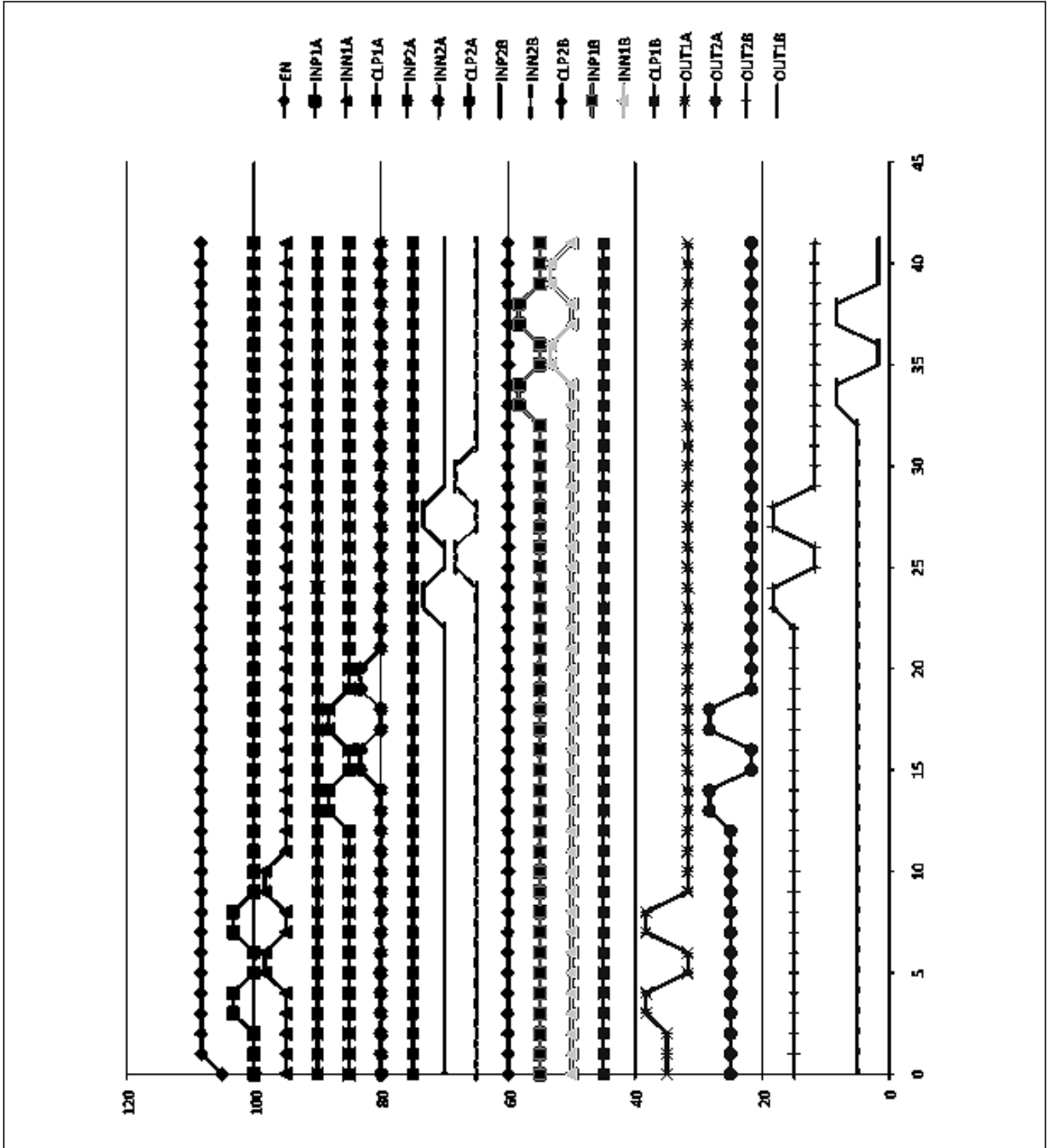

Figure 4. Waveform A: NRZ Pulses with EN, INP First

MAX4940 Evaluation Kit/Master Board

Evaluate: MAX4940/MAX4940A

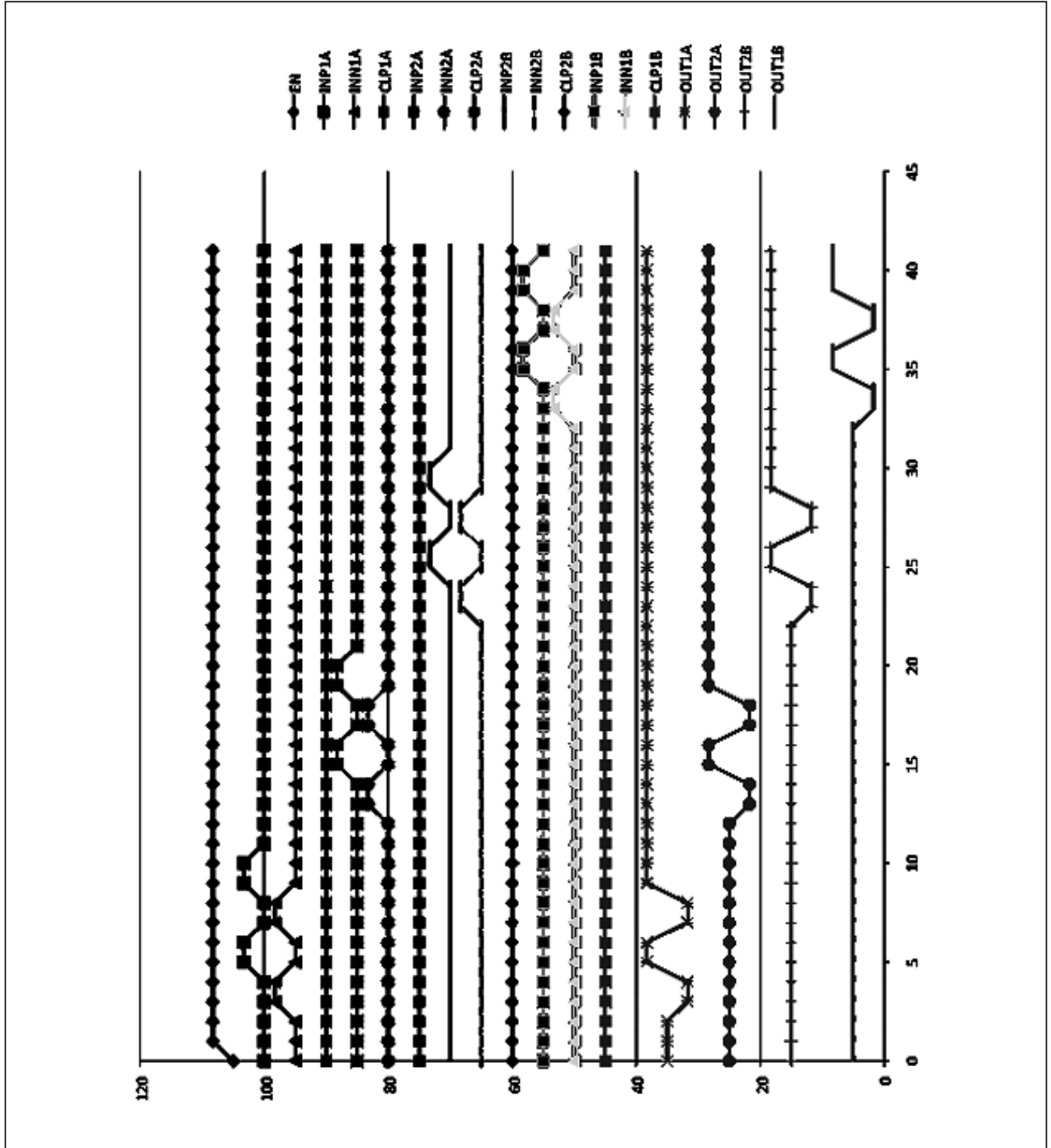

Figure 5. Waveform B: NRZ Pulses with EN, INN First

MAX4940 Evaluation Kit/Master Board

Evaluate: MAX4940/MAX4940A

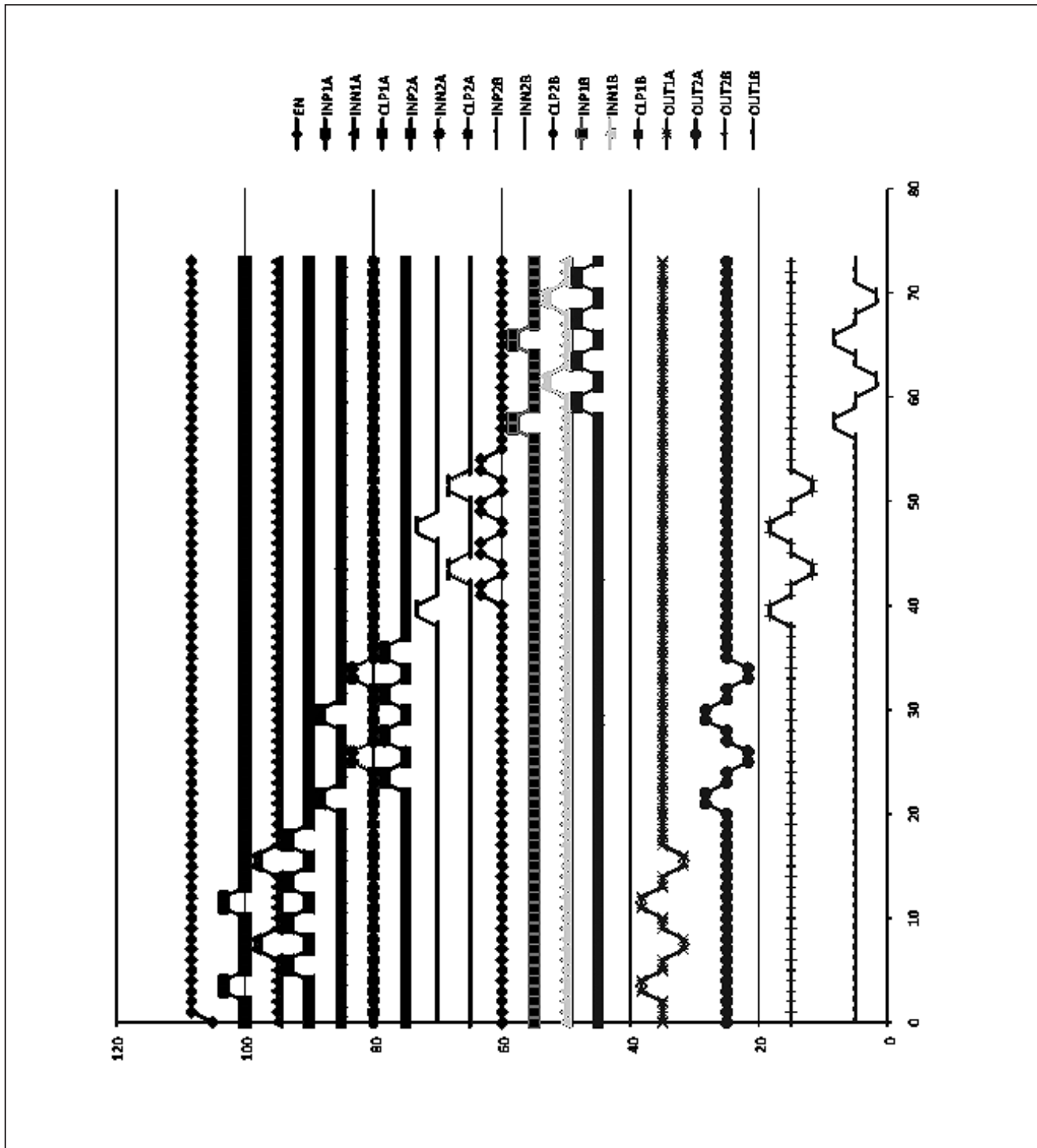

Figure 6. Waveform C: RZ Pulses with Clamp, INP First

MAX4940 Evaluation Kit/Master Board

Evaluate: MAX4940/MAX4940A

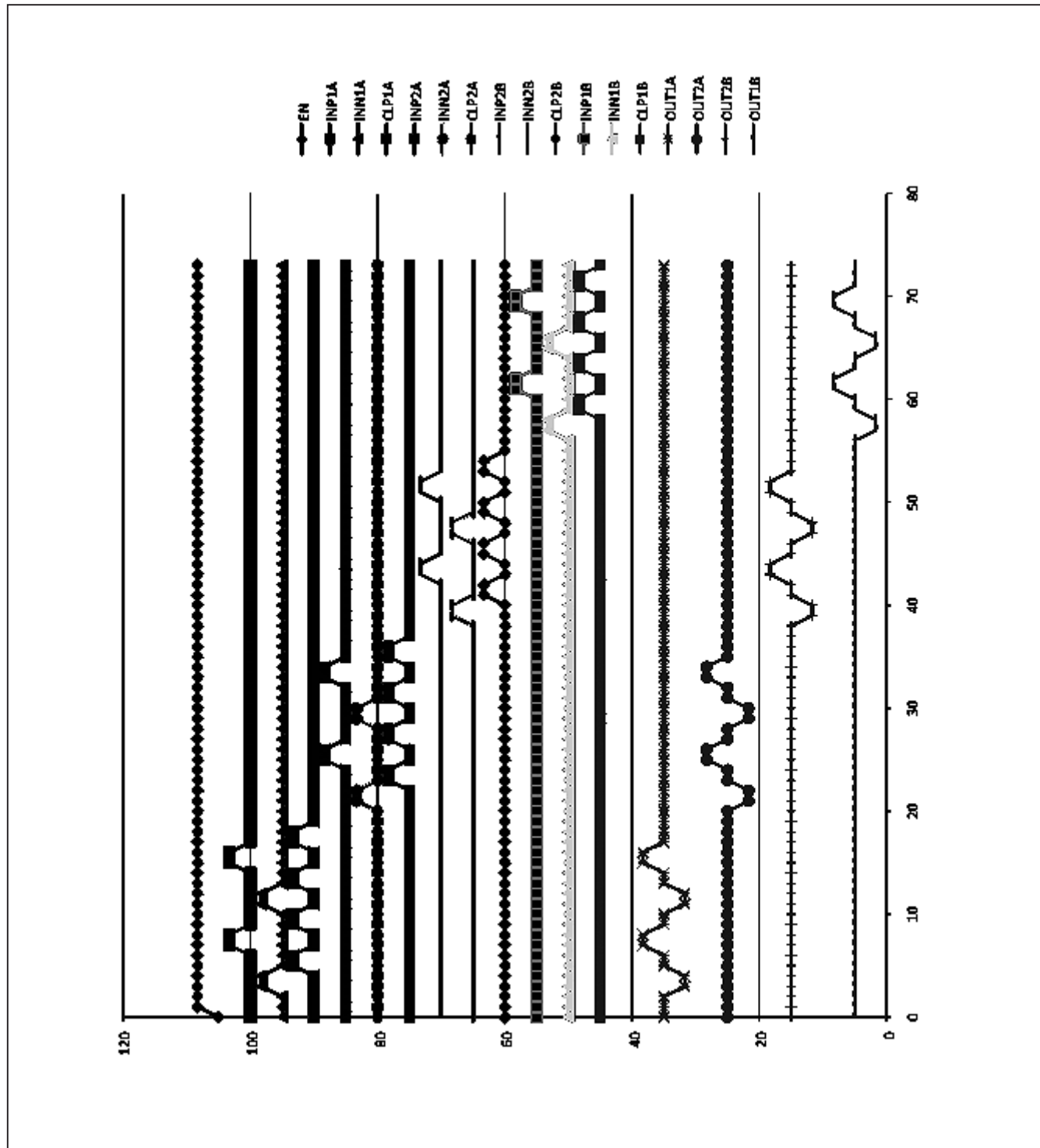

Figure 7. Waveform D: RZ Pulses with Clamp, INN First

MAX4940 Evaluation Kit/Master Board

Evaluate: MAX4940/MAX4940A

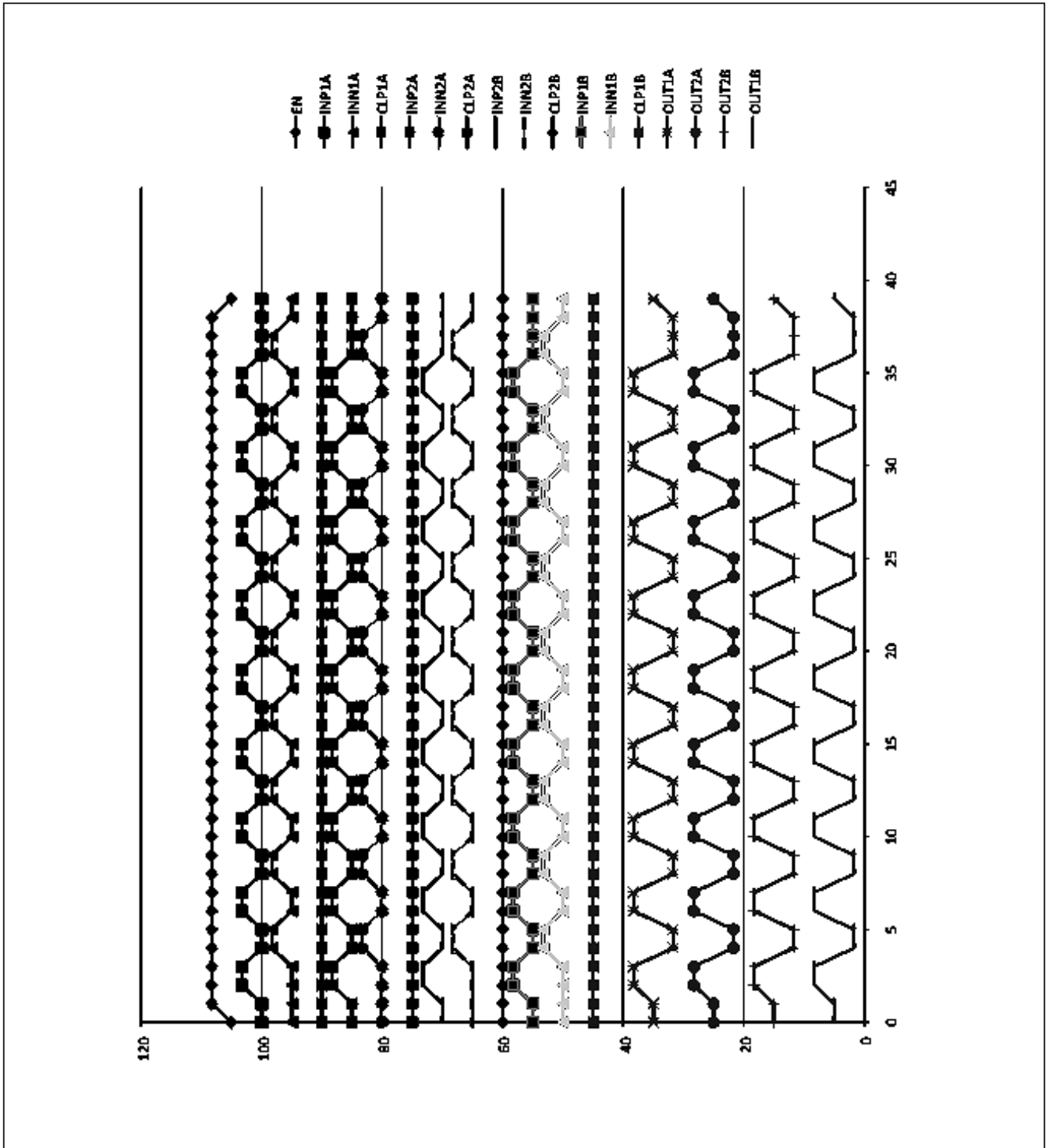

Figure 8. Waveform E: Alternating INP and INN

MAX4940 Evaluation Kit/Master Board

Evaluate: MAX4940/MAX4940A

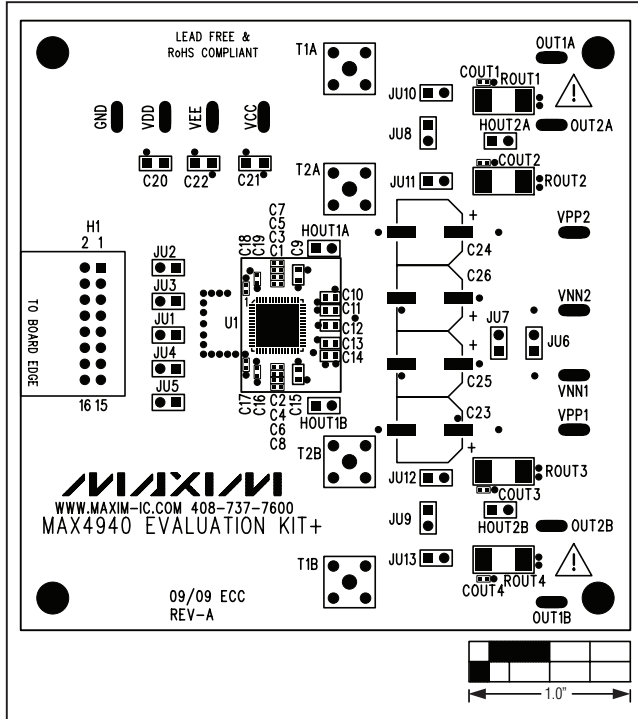

Figure 10. MAX4940 EV Kit Component Placement Guide—Component Side

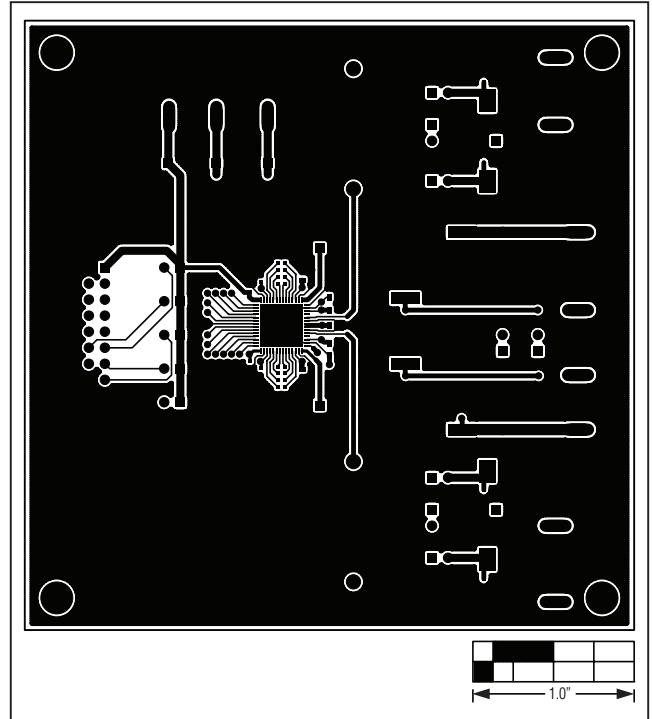

Figure 11. MAX4940 EV Kit PCB Layout—Component Side

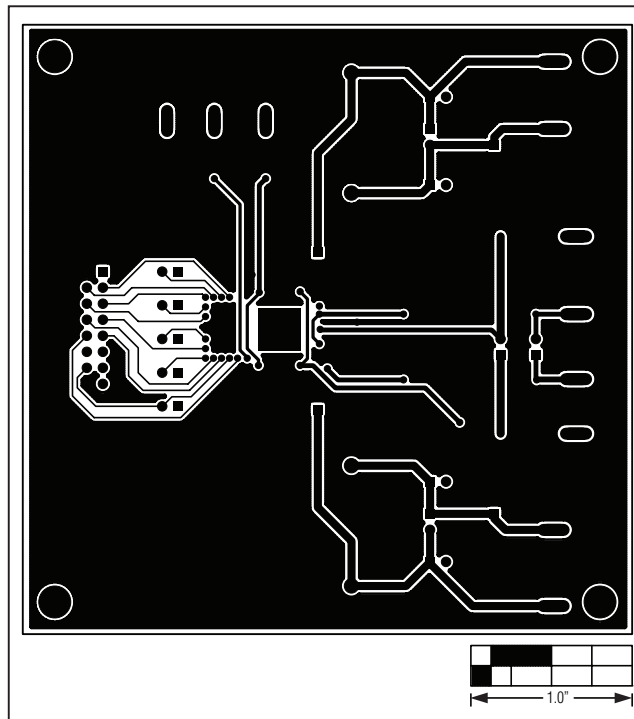

Figure 12. MAX4940 EV Kit PCB Layout—Solder Side

MAX4940 Evaluation Kit/Master Board

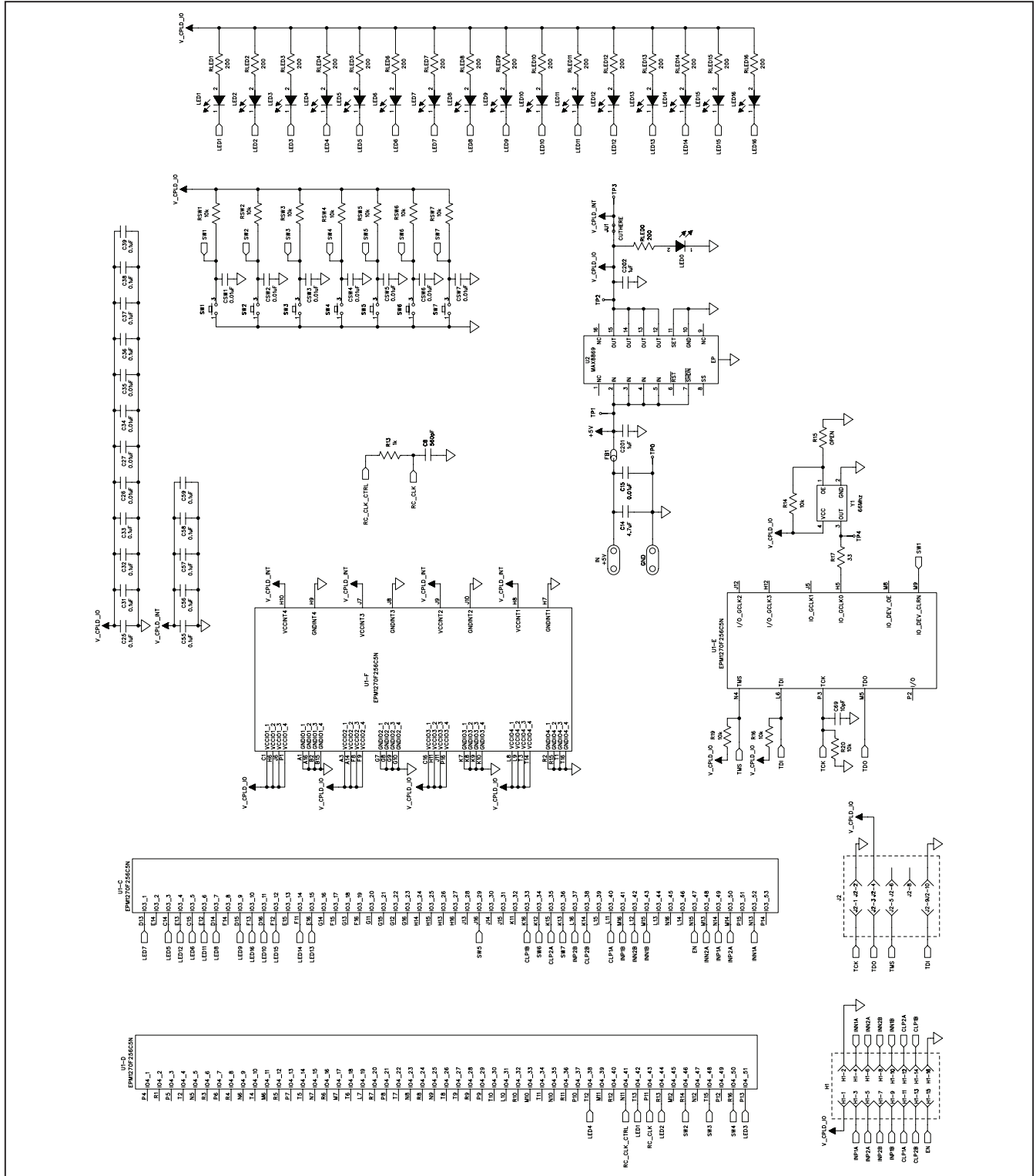

Figure 13. MAX4940 Master Board Schematic

MAX4940 Evaluation Kit/Master Board

Evaluate: MAX4940/MAX4940A

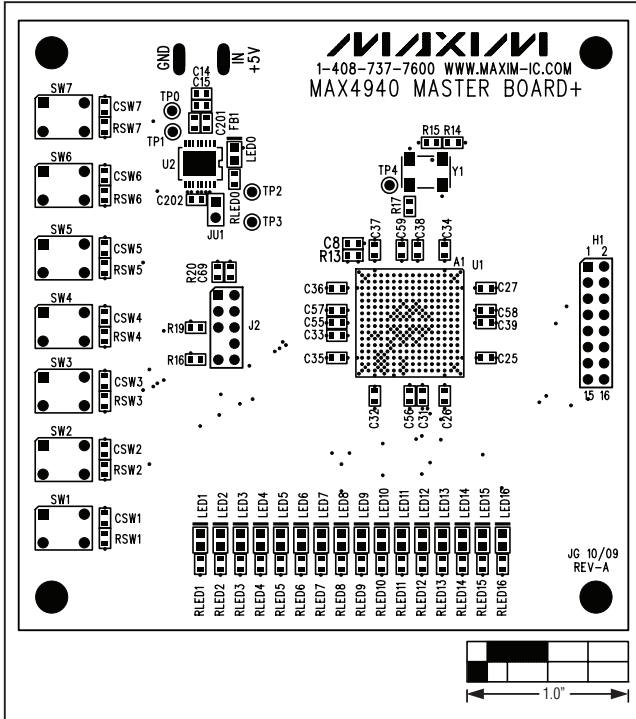

Figure 14. MAX4940 Master Board Component Placement Guide—Component Side

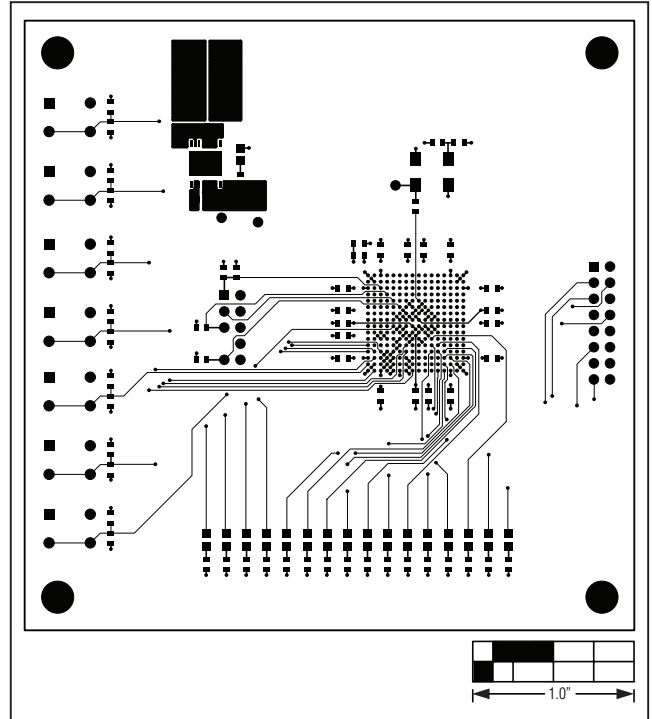

Figure 15. MAX4940 Master Board PCB Layout—Component Side

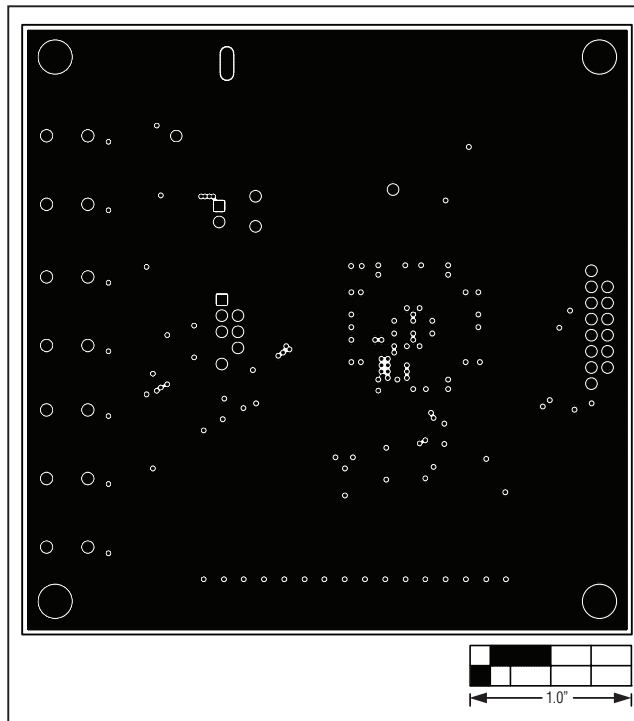

Figure 16. MAX4940 Master Board PCB Layout—Ground Layer 2

MAX4940 Evaluation Kit/Master Board

Evaluate: MAX4940/MAX4940A

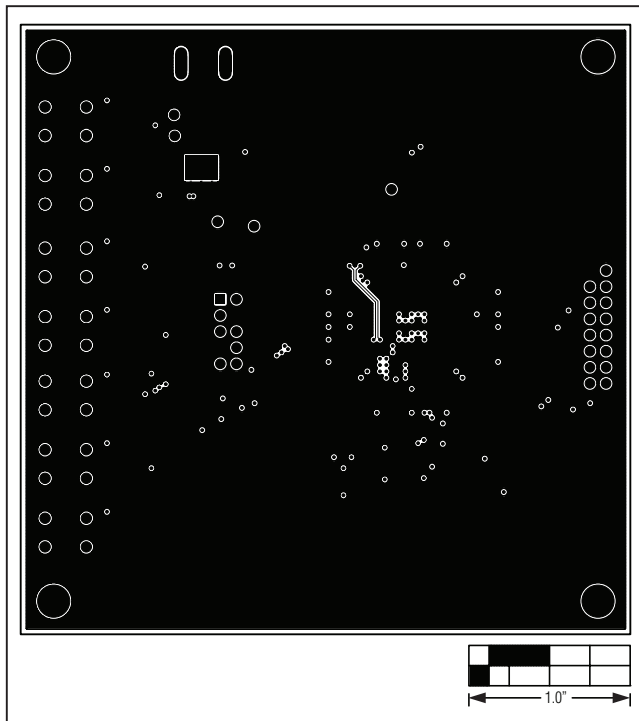

Figure 17. MAX4940 Master Board PCB Layout—Power Layer 3

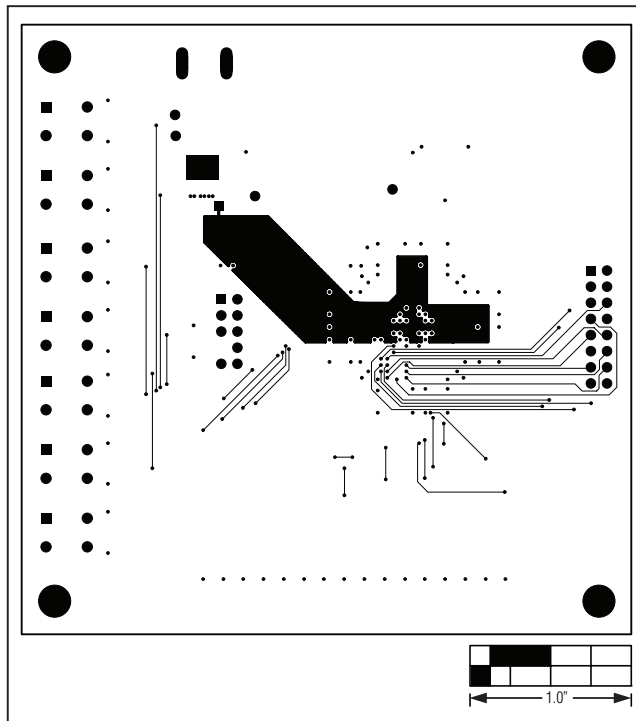

Figure 18. MAX4940 Master Board PCB Layout—Solder Side

Maxim cannot assume responsibility for use of any circuitry other than circuitry entirely embodied in a Maxim product. No circuit patent licenses are implied. Maxim reserves the right to change the circuitry and specifications without notice at any time.

18 **Maxim Integrated Products, 120 San Gabriel Drive, Sunnyvale, CA 94086 408-737-7600**

© 2009 Maxim Integrated Products

Maxim is a registered trademark of Maxim Integrated Products, Inc.

X-ON Electronics

Largest Supplier of Electrical and Electronic Components

Click to view similar products for [Power Management IC Development Tools](#) category:

Click to view products by [Maxim](#) manufacturer:

Other Similar products are found below :

[EVB-EP5348UI](#) [MIC23451-AAAYFL EV](#) [MIC5281YMME EV](#) [124352-HMC860LP3E](#) [DA9063-EVAL](#) [ADP122-3.3-EVALZ](#) [ADP130-0.8-EVALZ](#) [ADP130-1.8-EVALZ](#) [ADP1740-1.5-EVALZ](#) [ADP1870-0.3-EVALZ](#) [ADP1874-0.3-EVALZ](#) [ADP199CB-EVALZ](#) [ADP2102-1.25-EVALZ](#) [ADP2102-1.875EVALZ](#) [ADP2102-1.8-EVALZ](#) [ADP2102-2-EVALZ](#) [ADP2102-3-EVALZ](#) [ADP2102-4-EVALZ](#) [AS3606-DB](#) [BQ25010EVM](#) [BQ3055EVM](#) [ISLUSBI2CKIT1Z](#) [LP38512TS-1.8EV](#) [EVAL-ADM1186-1MBZ](#) [EVAL-ADM1186-2MBZ](#) [ADP122UJZ-REDYKIT](#) [ADP166Z-REDYKIT](#) [ADP170-1.8-EVALZ](#) [ADP171-EVALZ](#) [ADP1853-EVALZ](#) [ADP1873-0.3-EVALZ](#) [ADP198CP-EVALZ](#) [ADP2102-1.0-EVALZ](#) [ADP2102-1-EVALZ](#) [ADP2107-1.8-EVALZ](#) [ADP5020CP-EVALZ](#) [CC-ACC-DBMX-51](#) [ATPL230A-EK](#) [MIC23250-S4YMT EV](#) [MIC26603YJL EV](#) [MIC33050-SYHL EV](#) [TPS60100EVM-131](#) [TPS65010EVM-230](#) [TPS71933-28EVM-213](#) [TPS72728YFFEVM-407](#) [TPS79318YEQEVM](#) [UCC28810EVM-002](#) [XILINXPWR-083](#) [LMR22007YMINI-EVM](#) [LP38501ATJ-EV](#)