

# MAX5086

## 45V, 250mA, Low-Quiescent-Current Linear Regulator with Adjustable Reset Delay

### General Description

The MAX5086 high-voltage linear regulator operates from a 6.5V to 45V input voltage and delivers up to a 250mA output current. The device consumes only 70 $\mu$ A of quiescent current with no load and 13 $\mu$ A in shutdown. The device includes a SET input, that when connected to ground, selects a preset output voltage of 3.3V (MAX5086A) or 5.0V (MAX5086B). Alternatively, the output voltage can be adjusted from 2.5V to 11V by simply connecting SET to the regulator's output through a resistive divider network. The MAX5086 also provides an open-drain, active-low microprocessor reset output that asserts when the regulator output drops below the preset output voltage threshold. An external capacitor programs the reset timeout period. Other features include an enable input, thermal shutdown, and short-circuit protection.

The MAX5086 operates over the automotive temperature range of -40°C to +125°C and is available in a 16-pin TQFN thermally enhanced package.

### Applications

- Industrial
- Home Security/Safety
- Networking

### Features

- Wide Operating Input Voltage Range (6.5V to 45V)
- Thermally Enhanced Package Dissipates 2.6W at  $T_A = +70^\circ\text{C}$  (16-Pin TQFN)
- Guaranteed 250mA Output Current
- 70 $\mu$ A Quiescent Supply Current
- Preset 3.3V, 5.0V, or Adjustable 2.5V to 11V Output Voltage
- Remote Load Sense
- Integrated Microprocessor Reset Circuit with Programmable Timeout Period
- Thermal and Short-Circuit Protection
- -40°C to +125°C Operating Temperature Range

### Ordering Information

PART	OUTPUT VOLTAGE (V)	PIN-PACKAGE
MAX5086AATE+	3.3	16 TQFN-EP*
MAX5086AATE	3.3	16 TQFN-EP*
MAX5086BATE+	5.0	16 TQFN-EP*
MAX5086BATE	5.0	16 TQFN-EP*

**Note:** All devices are specified over the -40°C to +125°C operating temperature range.

+Denotes a lead(Pb)-free/RoHS-compliant package.

\*EP = Exposed pad.

### Pin Configuration

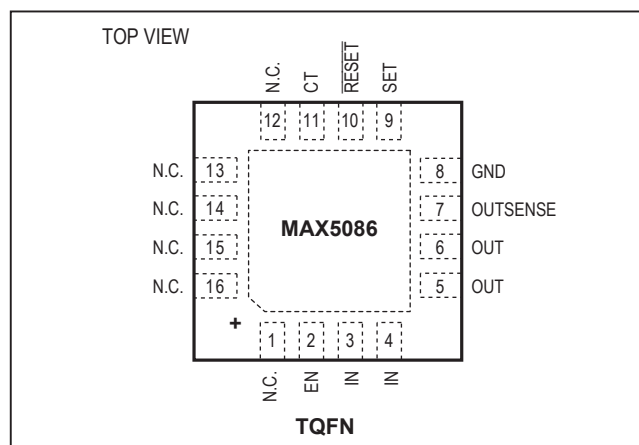

### Absolute Maximum Ratings

IN to GND (do not exceed package power dissipation).....	-0.3V to +50V	Continuous Power Dissipation (T <sub>A</sub> = +70°C) TQFN (derate 33.3mW/°C above +70°C).....	2666mW
IN to GND (T ≤ 300ms, I <sub>OUT</sub> ≤ 250mA).....	-0.3V to +42V	Thermal Resistance (Note 1):	
EN to GND .....	-0.3V to +50V	(θ <sub>JA</sub> , 16-Pin TQFN) .....	30.0°C/W
RESET, OUT, OUTSENSE to GND .....	-0.3V to +12V	(θ <sub>JC</sub> , 16-Pin TQFN) .....	2°C/W
CT, SET to GND .....	-0.3V to +3.5V	Operating Temperature Range.....	-40°C to +125°C
IN to OUT .....	-0.3V to +50V	Junction Temperature.....	+150°C
Short-Circuit Duration (V <sub>IN</sub> < 16V).....	Continuous	Storage Temperature Range .....	-60°C to +150°C
Maximum Current into Any Pin (except IN, OUT).....	±20mA	Lead Temperature (soldering, 10s) .....	+300°C

**Note 1:** Package thermal resistances were obtained using the method described in JEDEC specification JESD51-7, using a four-layer board. For detailed information on package thermal considerations, refer to [www.maximintegrated.com/thermal-tutorial](http://www.maximintegrated.com/thermal-tutorial).

Stresses beyond those listed under "Absolute Maximum Ratings" may cause permanent damage to the device. These are stress ratings only, and functional operation of the device at these or any other conditions beyond those indicated in the operational sections of the specifications is not implied. Exposure to absolute maximum rating conditions for extended periods may affect device reliability.

### Electrical Characteristics

(V<sub>IN</sub> = 14V, I<sub>OUT</sub> = 1mA, C<sub>IN</sub> = 47µF (low ESR), C<sub>OUT</sub> = 15µF, V<sub>EN</sub> = 2.4V, 10kΩ from RESET to OUT, T<sub>A</sub> = T<sub>J</sub> = -40°C to +125°C, unless otherwise noted. Typical specifications are at T<sub>A</sub> = +25°C.) (Note 2)

PARAMETER	SYMBOL	CONDITIONS		MIN	TYP	MAX	UNITS
Input Voltage Range	V <sub>IN</sub>	V <sub>IN</sub> ≥ V <sub>OUT</sub> + 1.5V		6.5		45	V
Supply Current	I <sub>Q</sub>	Measured at GND, SET = GND	I <sub>OUT</sub> = 0		70	115	µA
			I <sub>OUT</sub> = 250mA		1250		
Shutdown Supply Current	I <sub>SHDN</sub>	V <sub>EN</sub> ≤ 0.4V			13	21	µA
<b>REGULATOR</b>							
Guaranteed Output Current	I <sub>OUT</sub>	V <sub>IN</sub> = 6.5V, V <sub>OUT</sub> = 5.0V		250			mA
Output Voltage (Note 3)	V <sub>OUT</sub>	SET = GND, 5V Version	6.5V ≤ V <sub>IN</sub> ≤ 25V, 5mA ≤ I <sub>OUT</sub> ≤ 250mA	4.85	5	5.15	V
			6.5V ≤ V <sub>IN</sub> ≤ 45V, 5mA ≤ I <sub>OUT</sub> ≤ 100mA	4.85	5	5.15	
		SET = GND, 3.3V version	6.5V ≤ V <sub>IN</sub> ≤ 25V, 5mA ≤ I <sub>OUT</sub> ≤ 250mA	3.217	3.3	3.392	
			6.5V ≤ V <sub>IN</sub> ≤ 45V, 5mA ≤ I <sub>OUT</sub> ≤ 100mA	3.217	3.3	3.392	
		I <sub>OUT</sub> = 5mA, adjustable range			2.5		
Dropout Voltage (Note 4)	ΔV <sub>DO</sub>	I <sub>OUT</sub> = 250mA, V <sub>OUT</sub> = 5V			0.9	2.2	V
Startup Response Time (Note 5)		Rising edge of V <sub>IN</sub> to V <sub>OUT</sub> , R <sub>L</sub> = 500Ω, SET = GND			400		µs
Line Regulation	ΔV <sub>OUT</sub> /ΔV <sub>IN</sub>	6.5V ≤ V <sub>IN</sub> ≤ 45V	5V version	-1		+1	mV/V
			3.3V version	-0.5		+0.8	
Enable Voltage	V <sub>EN</sub>	V <sub>EN</sub> = high, regulator on		2.4			V
		V <sub>EN</sub> = low, regulator off				0.4	

**Electrical Characteristics (continued)**

( $V_{IN} = 14V$ ,  $I_{OUT} = 1mA$ ,  $C_{IN} = 47\mu F$  (low ESR),  $C_{OUT} = 15\mu F$ ,  $V_{EN} = 2.4V$ ,  $10k\Omega$  from  $\overline{RESET}$  to OUT,  $T_A = T_J = -40^\circ C$  to  $+125^\circ C$ , unless otherwise noted. Typical specifications are at  $T_A = +25^\circ C$ .) (Note 2)

PARAMETER	SYMBOL	CONDITIONS	MIN	TYP	MAX	UNITS
Enable Input Current	$I_{EN}$	$V_{EN} = 2.4V$		0.38		$\mu A$
		$V_{EN} = 14V$		3.75		
SET Reference Voltage	$V_{SET}$		1.20	1.235	1.26	V
SET Input Leakage Current	$I_{SET}$		-100	-1.5	100	nA
Load Regulation	$\frac{\Delta V_{OUT}}{\Delta I_{OUT}}$	$I_{OUT} = 1mA$ to 250mA		0.045	0.4	$\Omega$
Power-Supply Rejection Ratio	PSRR	$I_{OUT} = 10mA$ , $f = 100Hz$ , $500mV_{P-P}$ , $V_{OUT} = 5V$		-54		dB
Short-Circuit Current (Note 6)	$I_{SC}$	$V_{IN} < 16V$		440		mA
Thermal Shutdown Temperature	$T_{J(SHDN)}$			175		$^\circ C$
Thermal Shutdown Hysteresis	$\Delta T_{J(SHDN)}$			25		$^\circ C$
$\overline{RESET}$ Voltage Threshold	$V_{\overline{RESET}}$		89.91	92	94.10	% $V_{OUT}$
$\overline{RESET}$ Threshold Hysteresis	$V_{RHYST}$			2		% $V_{OUT}$
$\overline{RESET}$ Output Low Voltage	$V_{RL}$	$I_{SINK} = 1mA$			0.4	V
$\overline{RESET}$ Output Leakage Current	$I_{RH}$	$V_{\overline{RESET}} = 5V$			1	$\mu A$
$\overline{RESET}$ Output Minimum Timeout Period		When $V_{OUT}$ reaches $\overline{RESET}$ threshold, $C_{CT} = Open$		15		$\mu s$
ENABLE to $\overline{RESET}$ Minimum Timeout Period		When EN goes high, $C_{CT} = open$		169		$\mu s$
Delay Comparator Threshold (Rising)			1.196	1.23	1.264	V
Delay Comparator Threshold Hysteresis				100		mV
CT Charge Current			1	2.26	4	$\mu A$
CT Discharge Current				5		mA

**Note 2:** Limits at  $-40^\circ C$  are guaranteed by design.

**Note 3:** Output voltage is tested using a pulsed load current of less than 50ms duration.

**Note 4:** Dropout voltage is defined as  $(V_{IN} - V_{OUT})$  when  $V_{OUT}$  is 100mV below the value of  $V_{OUT}$  for  $V_{IN} = V_{OUT} + 3V$ .

**Note 5:** Startup time measured from 50% of  $V_{IN}$  to 90% of  $V_{OUT}$ .

**Note 6:** Continuous short-circuit protection for  $V_{IN} > 16V$  not guaranteed.

Typical Operating Characteristics

( $V_{IN} = V_{EN} = 14V$ ,  $C_{IN} = 47\mu F$  (low ESR),  $C_{OUT} = 15\mu F$ ,  $V_{OUT} = 5V$ ,  $SET = GND$ ,  $T_A = +25^\circ C$ , unless otherwise specified.)

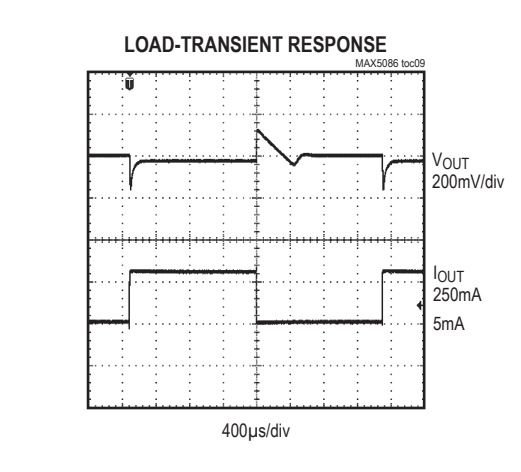
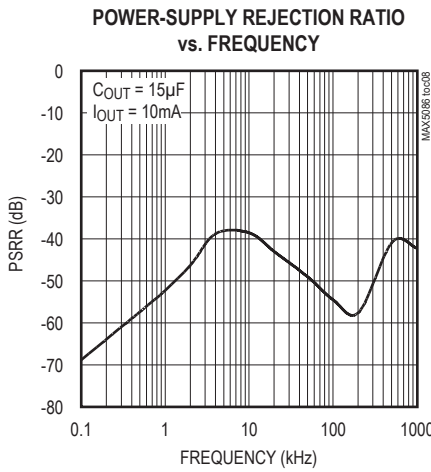
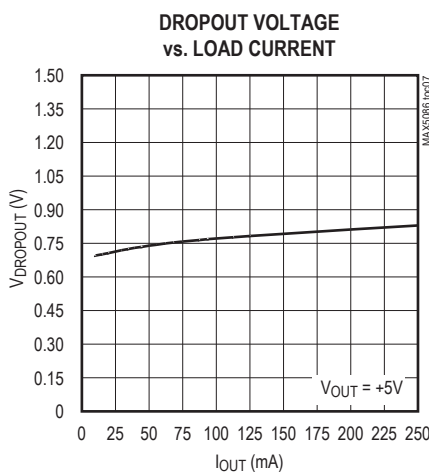
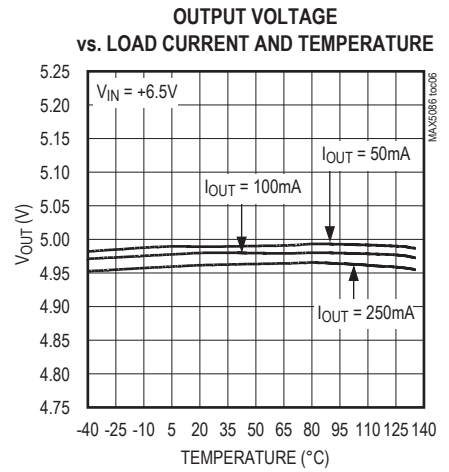
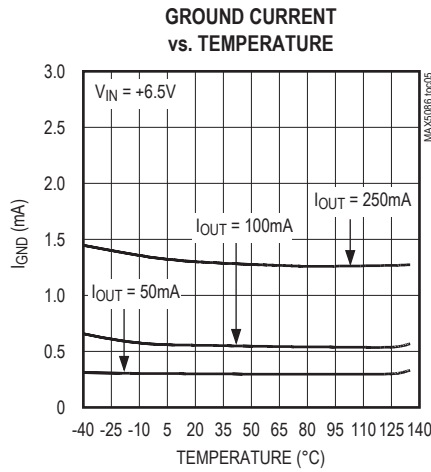
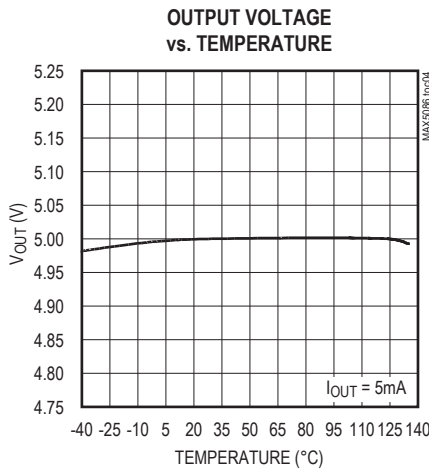
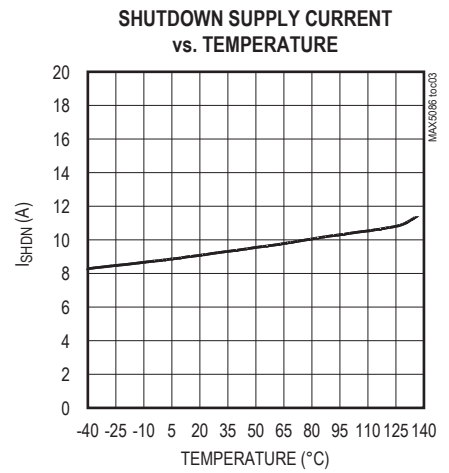
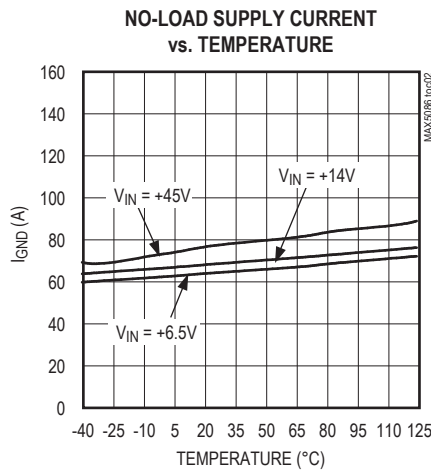
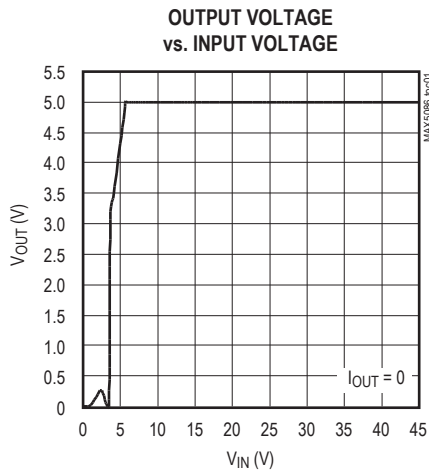

Typical Operating Characteristics (continued)

( $V_{IN} = V_{EN} = 14V$ ,  $C_{IN} = 47\mu F$  (low ESR),  $C_{OUT} = 15\mu F$ ,  $V_{OUT} = 5V$ , SET = GND,  $T_A = +25^\circ C$ , unless otherwise specified.)

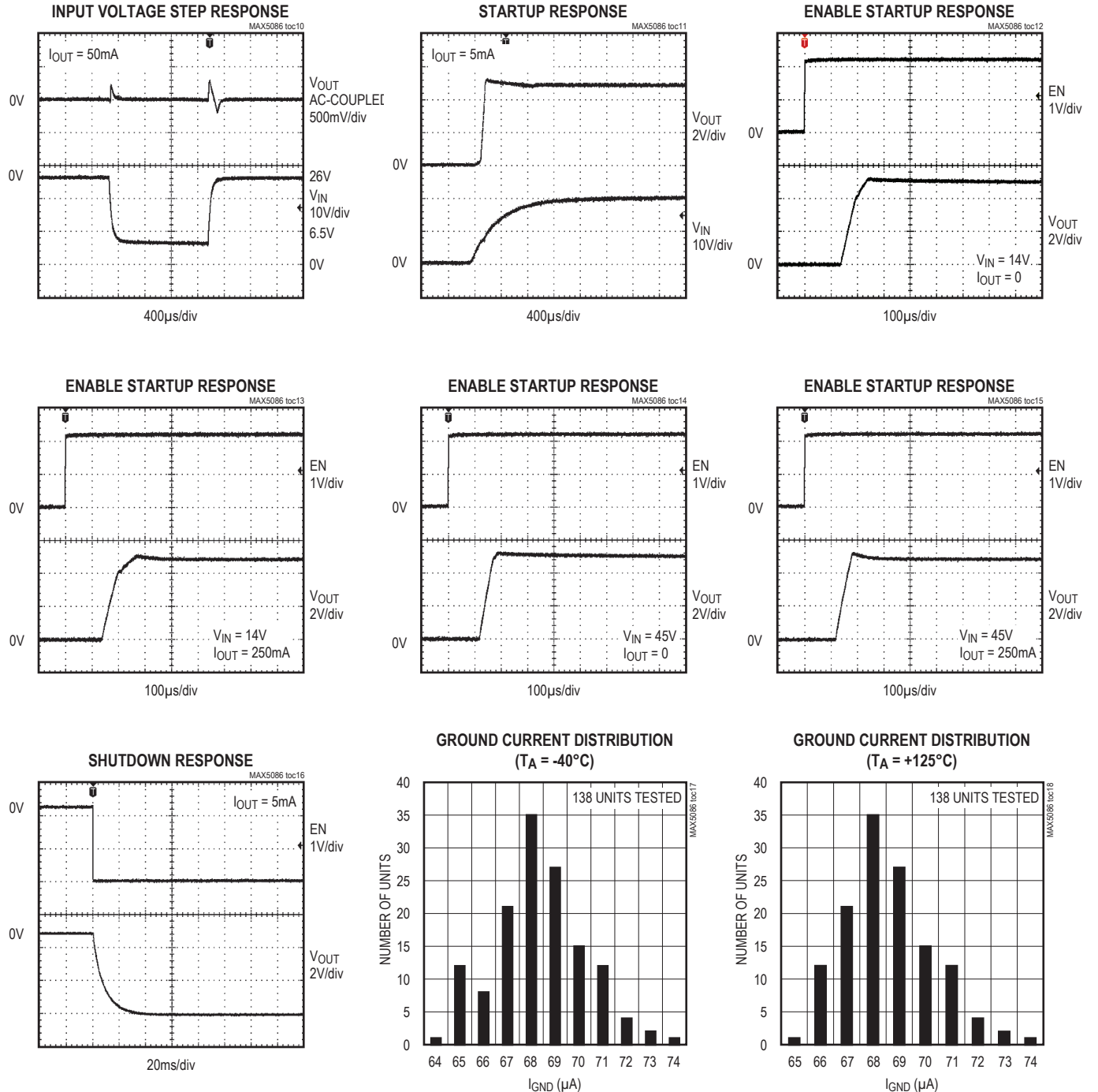

## Pin Description

PIN	NAME	FUNCTION
1, 12–16	N.C.	No Connection. Not internally connected.
2	EN	Enable Input. Drive EN high to turn on the regulator. Force EN low to place the device in shutdown mode.
3, 4	IN	Regulator Input. Supply voltage ranges from 6.5V to 45V. Bypass IN to GND with a low ESR 47 $\mu$ F capacitor (electrolytic 50VL).
5, 6	OUT	Regulator Output. Connect at least a 15 $\mu$ F low-ESR capacitor from OUT to GND.
7	OUTSENSE	Regulator Output Feedback Point. OUTSENSE must be connected to OUT for fixed output voltage versions. Leave OUTSENSE open circuit for adjustable output voltage version.
8	GND	Ground
9	SET	Feedback Regulation Set Point. Connect SET to GND for a fixed 3.3V output (MAX5086A) or 5.0V output (MAX5086B). Connect an external resistive divider network from OUTSENSE to SET to GND to adjust the output voltage from 2.5V to 11V.
10	$\overline{\text{RESET}}$	Open-Drain Active-Low Reset Output. Connect a 10k $\Omega$ pullup resistor from $\overline{\text{RESET}}$ to any supply voltage up to 11V to create a logic output.
11	CT	Reset Timeout Setting Connection. A 2 $\mu$ A charging current is available at CT. Connect a capacitor from CT to GND to set the reset timeout period (see the <i>Adjustable Reset Timeout Period (CT)</i> section).
EP	EP	Exposed Pad. Connect externally to a large ground plane to aid heat dissipation. Do not use EP as the only ground connection.

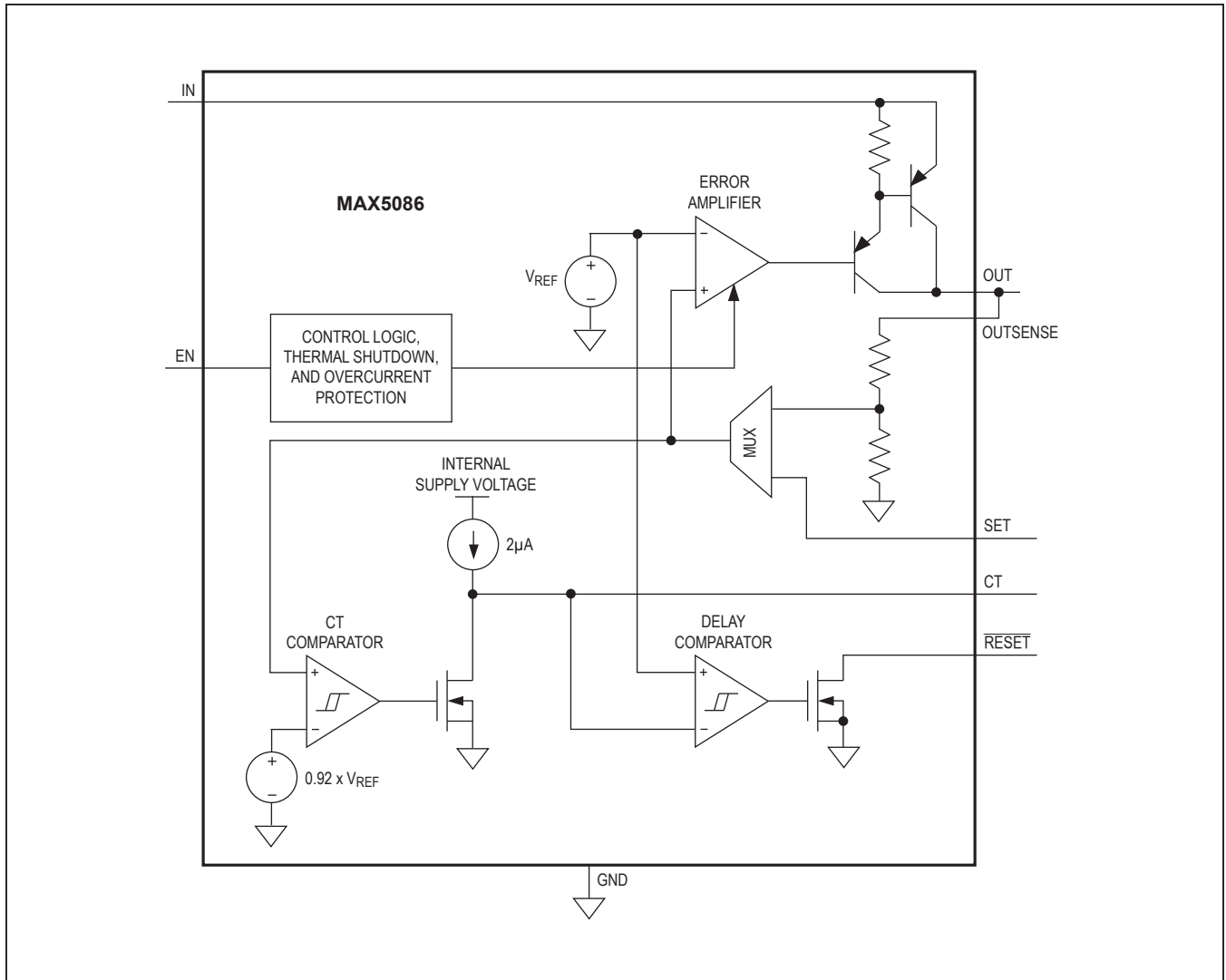

Figure 1. Functional Diagram

## Detailed Description

The MAX5086 high-voltage linear regulator includes an integrated microprocessor reset circuit with an adjustable reset timeout period (see the *Adjustable Reset Timeout Period (CT)* section). The device guarantees a 250mA load current and is available with a preset output voltage of 3.3V (MAX5086A) or 5V (MAX5086B). Both devices can be configured to provide an adjustable output voltage from 2.5V to 11V. The internal reset circuit monitors the regulator output voltage and asserts  $\overline{\text{RESET}}$  low when the regulator output falls below the reset threshold voltage. Other features include an enable (regulator control input), 21 $\mu\text{A}$  (max) shutdown current, short-circuit protection (see the *Output Short-Circuit Current Limit* section), and thermal shutdown (see the *Thermal Protection* section).

### Regulator

The MAX5086 accepts an input voltage range from 6.5V to 45V and offers a fixed output voltage of 3.3V or 5V. For an adjustable output voltage operation, use an external resistive divider network connected between OUT, SET, and GND (see Figure 2).

### Enable Input (EN)

EN is a logic-level enable input that turns ON/OFF the device. Drive EN high to turn on the device and drive EN low to place the device in shutdown. The MAX5086 draws 13 $\mu\text{A}$  (typ) of supply current when in shutdown. EN withstands voltages up to +45V, allowing EN to be connected to IN for an always-on operation.

### Remote Sensing (OUTSENSE)

For fixed output voltage versions, OUTSENSE must be used for load voltage sensing. Leave OUTSENSE open circuit when using adjustable output voltage version.

### Reset Output ( $\overline{\text{RESET}}$ )

A supervisor circuit is fully integrated in the MAX5086 and uses the same reference voltage as the regulator.  $\overline{\text{RESET}}$  goes low if  $V_{\text{OUT}}$  drops below the preset output voltage threshold, and remains low at least for the timeout period after  $V_{\text{OUT}}$  rises above the reset voltage threshold.

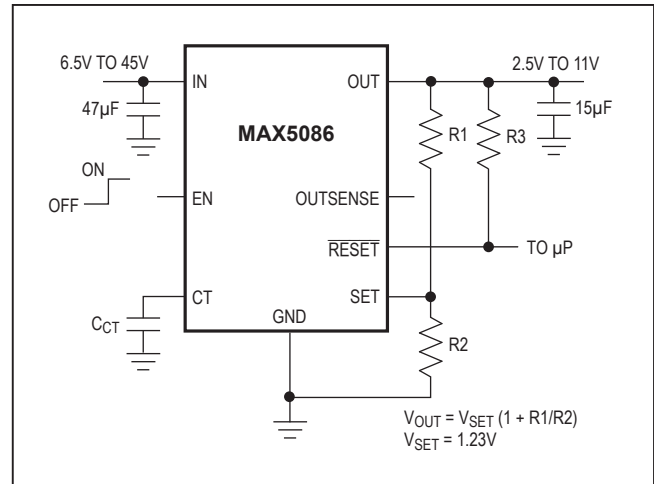

Figure 2. Setting the Adjustable Output Voltage

### Adjustable Reset Timeout Period (CT)

The MAX5086 features a user-adjustable reset timeout. Connect a capacitor from CT to GND to set the reset timeout period (see Figure 2) and use the following equation to calculate the timeout period:

$$t_{\text{RP}} = C_{\text{CT}} \times 0.6175 \times 10^6$$

where  $C_{\text{CT}}$  is the value of the external capacitor connected from CT to GND and  $t_{\text{RP}}$  is in seconds.

### Thermal Protection

When the junction temperature exceeds  $T_{\text{J}} = 175^{\circ}\text{C}$  an internal thermal sensor signals the shutdown logic, which turns off the pass transistor, allowing the IC to cool. The thermal sensor turns the pass transistor on again after the IC's junction temperature cools by  $25^{\circ}\text{C}$ , resulting in a cycled output during continuous thermal-overload conditions. Thermal protection protects the MAX5086 in the event of fault conditions. During continuous operation, do not exceed the absolute maximum junction temperature rating of  $T_{\text{J}} = +150^{\circ}\text{C}$ .

### Output Short-Circuit Current Limit

The MAX5086 features a current limit. The output can be shorted to GND for an indefinite period of time (for  $V_{\text{IN}} < 16\text{V}$ ) without damage to the device.



**Applications Information**

**Output Voltage Selection**

The MAX5086 features dual-mode operation, in either a preset voltage mode or an adjustable mode. In preset voltage mode, internal feedback resistors set the MAX5086's output voltage to +3.3V or +5V. Select preset voltage mode by connecting SET to ground. In adjustable mode, select an output between +2.5V and +11V using two external resistors connected as a voltage-divider to SET (Figure 2). Set the output voltage using the following equation:

$$V_{OUT} = V_{SET} \times \left(1 + \frac{R1}{R2}\right)$$

where  $V_{SET} = 1.23V$  and  $R2$  is chosen to be approximately 100kΩ.

**Available Output Current Calculation**

The MAX5086 high-voltage regulator provides up to 250mA of output current. The input voltage extends to +45V. Package power dissipation limits the amount of output current available for a given input/output voltage and ambient temperature. Figure 3 depicts the maximum power dissipation curve for these devices. The graph assumes that the exposed pad of the MAX5086 package is set up per JEDEC specifications.

Use Figure 3 to determine the allowable package dissipation ( $P_D$ ) for a given ambient temperature. Alternately, use the following formula to calculate the allowable package dissipation:

$$P_D = \begin{cases} 2.666W & \text{for } T_A \leq +70^\circ C \\ 2.666W - 0.0333 \frac{W}{^\circ C} \times (T_A - 70^\circ C) & \\ \text{For } +70^\circ C < T_A \leq +125^\circ C \end{cases}$$

After determining the allowable package dissipation calculate the maximum output current using the following formula:

$$I_{OUT(MAX)} \cong \frac{P_D}{V_{IN} - V_{OUT}} \leq 250mA$$

The above equations do not include the negligible power dissipation from self-heating due to the IC ground current.

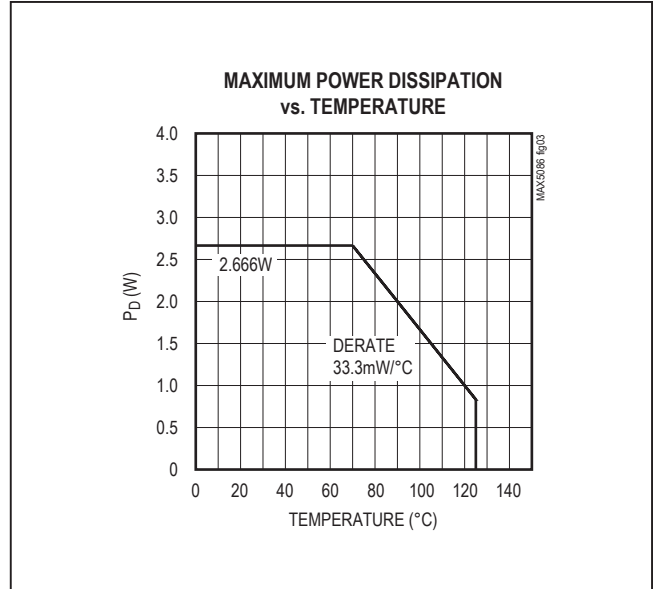

Figure 3. Calculated Maximum Power Dissipation vs. Temperature

**Example 1:**

- $T_A = +85^\circ C$
- $V_{IN} = +14V$
- $V_{OUT} = +5V$

Find the maximum allowable output current. First calculate package dissipation at the given temperature as follows:

$$P_D = 2.666W - 0.0333 \frac{W}{^\circ C} (85^\circ C - 70^\circ C) = 2.1665W$$

Then determine the maximum output current:

$$I_{OUT(MAX)} = \frac{(2.1665W)}{(14V) - (5V)} = 271mA$$

**Example 2:**

$T_A = +125^{\circ}\text{C}$

$V_{IN} = +14\text{V}$

$V_{OUT} = +5\text{V}$

Calculate package dissipation at the given temperature as follows:

$$P_D = 2.666\text{W} - 0.0333 \frac{\text{W}}{^{\circ}\text{C}} (125^{\circ}\text{C} - 70^{\circ}\text{C}) = 0.8345\text{W}$$

And establish the maximum current:

$$I_{OUT(MAX)} = \frac{(0.8345\text{W})}{(14\text{V}) - (5\text{V})} = 92\text{mA}$$

**Example 3:**

$T_A = +50^{\circ}\text{C}$

$V_{IN} = +14\text{V}$

$V_{OUT} = +5\text{V}$

Calculate package dissipation at the given temperature as follows:

$$P_D = 2.666\text{W}$$

And find the maximum output current:

$$I_{OUT(MAX)} = \frac{(2.666\text{W})}{(14\text{V}) - (5\text{V})} = 296\text{mA} \Rightarrow I_{OUT(MAX)} = 250\text{mA}$$

In Example 3, the maximum output current is calculated as 296mA, however, the maximum output current cannot exceed 250mA.

Use Figure 4 to quickly determine maximum allowable output current for selected ambient temperatures.

**Output Capacitor Selection and Regulator Stability**

For stable operation over the full temperature range and with load currents up to 250mA, use a 15μF (min) output

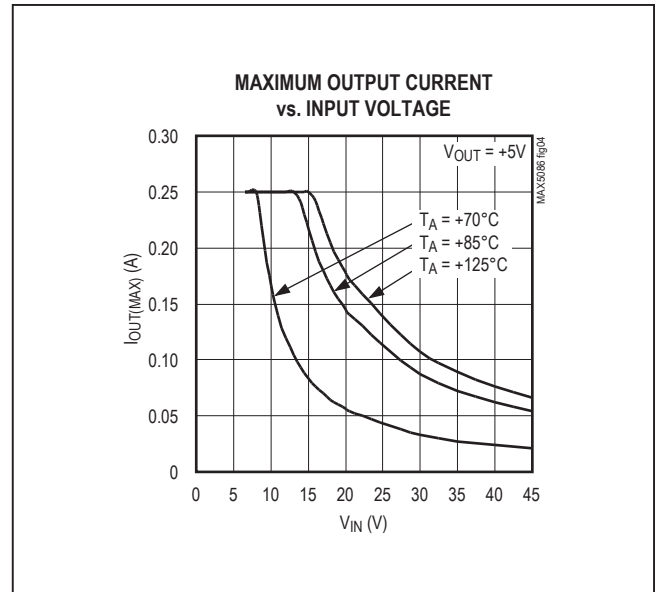

Figure 4. Maximum Output Current vs. Input Voltage

capacitor with an ESR < 0.25Ω. To reduce noise and improve load-transient response, stability, and power-supply rejection, use larger output capacitor values such as 22μF.

Some ceramic capacitor dielectrics exhibit large capacitance and ESR variation with temperature. For capacitor dielectrics such as Y5V, use 22μF or more to ensure stability at temperatures below -10°C. With X7R or X5R dielectrics, 15μF should be sufficient at all operating temperatures. To improve power supply rejection and transient response, use a minimum 47μF low ESR capacitor from IN to GND.

**Chip Information**

PROCESS: BiCMOS

---

MAX5086

45V, 250mA, Low-Quiescent-Current  
Linear Regulator with Adjustable Reset Delay

### Package Information

For the latest package outline information and land patterns (footprints), go to [www.maximintegrated.com/packages](http://www.maximintegrated.com/packages). Note that a "+", "#", or "-" in the package code indicates RoHS status only. Package drawings may show a different suffix character, but the drawing pertains to the package regardless of RoHS status.

PACKAGE TYPE	PACKAGE CODE	OUTLINE NO.	LAND PATTERN NO.
16 TQFN-EP	T1655+3	<a href="#">21-0140</a>	<a href="#">90-0073</a>

## Revision History

REVISION NUMBER	REVISION DATE	DESCRIPTION	PAGES CHANGED
1	7/06	Updated data sheet with improved output voltage parameters	2
2	2/08	Corrected errors in data sheet, reduced operating range, and removed unreleased product from the <i>Ordering Information</i> table	1–15
3	5/14	Removed “Automotive” from the <i>Applications</i> section	1

For pricing, delivery, and ordering information, please contact Maxim Direct at 1-888-629-4642, or visit Maxim Integrated's website at [www.maximintegrated.com](http://www.maximintegrated.com).

*Maxim Integrated cannot assume responsibility for use of any circuitry other than circuitry entirely embodied in a Maxim Integrated product. No circuit patent licenses are implied. Maxim Integrated reserves the right to change the circuitry and specifications without notice at any time. The parametric values (min and max limits) shown in the Electrical Characteristics table are guaranteed. Other parametric values quoted in this data sheet are provided for guidance.*

## X-ON Electronics

Largest Supplier of Electrical and Electronic Components

*Click to view similar products for [Linear Voltage Regulators](#) category:*

*Click to view products by [Maxim](#) manufacturer:*

Other Similar products are found below :

[LV56831P-E](#) [LV5684PVD-XH](#) [MCDTSA6-2R](#) [L7815ACV-DG](#) [LV56801P-E](#) [TCR3DF13,LM\(CT](#) [TCR3DF39,LM\(CT](#) [TLE42794G](#)  
[L78L05CZ/1SX](#) [L78LR05DL-MA-E](#) [LM317T](#) [636416C](#) [714954EB](#) [LV5680P-E](#) [L78M15CV-DG](#) [L79M05T-E](#) [TLS202A1MBVHTSA1](#)  
[L78LR05D-MA-E](#) [NCV317MBTG](#) [NTE7227](#) [NCV78M09BDTRKG](#) [LV5680NPVC-XH](#) [LT1054CN8](#) [ME6208A50M3G](#) [SL7533-8](#)  
[ME6231A50M3G](#) [ME6231A50PG](#) [ME6231C50M5G](#) [AMS1117S-3.3](#) [AMS1117-5.0](#) [AMS1117S-5.0](#) [AMS1117-3.3](#) [MD5118](#) [MD5121](#)  
[MD5127](#) [MD5128](#) [MD5130](#) [MD5144](#) [MD5150](#) [MD5115](#) [MD5125](#) [MD5136](#) [MD5140](#) [MD5110](#) [MD52E18WB6](#) [MD52E33WB6](#)  
[MD52E15QA3](#) [MD52E21QA3](#) [MD52E25QA3](#) [MD52E28QA3](#)