



Calibrated Quad 12-Bit Voltage-Output D/A Converters

MAX526/MAX527

General Description

The MAX526/MAX527 contain four 12-bit, voltage-output digital-to-analog converters (DACs). Precision output buffer amplifiers are included on-chip to provide voltage outputs. The MAX527 operates with $\pm 5V$ power supplies, while the MAX526 utilizes $-5V$ and $+12V$ to $+15V$ supplies. Offset, gain, and linearity are factory calibrated to provide the MAX526's 1LSB total unadjusted error (TUE).

These devices feature double-buffered interface logic with a 12-bit input register and a 12-bit DAC register. Data in the DAC register sets the DAC output voltage. The MAX526/MAX527 have an 8-bit-wide data bus. Data is loaded into the input register using two write operations with an 8-bit LSB write load and a 4-bit MSB write load. An asynchronous load DAC (LDAC) input transfers data from the input register to the DAC register. All logic inputs are TTL and CMOS compatible.

The MAX526/MAX527 are available in 24-pin, 300 mil plastic DIP, Ceramic SB, and wide SO packages.

Applications

- Minimum Component Count Analog Systems
- Digital Offset/Gain Adjustment
- Arbitrary Function Generators
- Industrial Process Controls
- Automatic Test Equipment

Functional Diagram

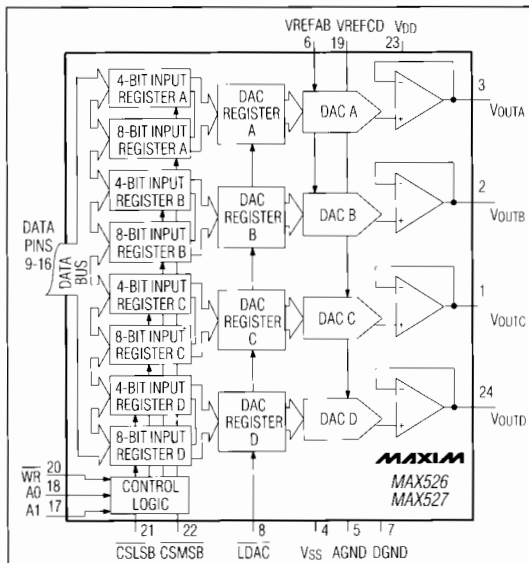

Features

- ◆ Reference Input Range Includes Ground (C, D grades)
- ◆ Full 12-Bit Performance Without Adjustments
- ◆ 1 LSB Total Unadjusted Error (MAX526)
- ◆ Buffered Voltage Outputs
- ◆ Fast Output Settling
3 μ s for MAX526
5 μ s for MAX527
- ◆ Double-Buffered Digital Inputs
- ◆ Microprocessor and TTL/CMOS Compatible
- ◆ $\pm 5V$ Supply Operation (MAX527)

Ordering Information

PART	TEMP. RANGE	PIN-PACKAGE	INL (LSBs)
MAX526CCNG	0°C to +70°C	24 Narrow Plastic DIP	$\pm 1/2$
MAX526DCNG	0°C to +70°C	24 Narrow Plastic DIP	± 1
MAX526CCWG	0°C to +70°C	24 Wide SO	$\pm 1/2$
MAX526DCWG	0°C to +70°C	24 Wide SO	± 1
MAX526DC/D	0°C to +70°C	Dice*	± 1
MAX526CENG	-40°C to +85°C	24 Narrow Plastic DIP	$\pm 1/2$
MAX526DENG	-40°C to +85°C	24 Narrow Plastic DIP	± 1
MAX526CEWG	-40°C to +85°C	24 Wide SO	$\pm 1/2$
MAX526DEWG	-40°C to +85°C	24 Wide SO	± 1
MAX526CMYG	-55°C to +125°C	24 Narrow Ceramic SB**	$\pm 1/2$
MAX526DMYG	-55°C to +125°C	24 Narrow Ceramic SB**	± 1

Ordering Information continued on last page.

* Contact factory for dice specifications.

** Contact factory for availability and processing to MIL-STD-883.

Pin Configuration

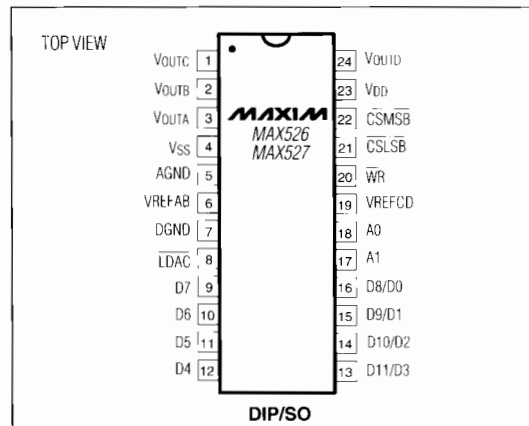

Call toll free 1-800-998-8800 for free samples or literature.

Calibrated Quad 12-Bit Voltage-Output D/A Converters

ABSOLUTE MAXIMUM RATINGS – MAX526

V _{DD} to AGND or DGND	-0.3V, +17V
V _{SS} to AGND or DGND	-7V, to 0.3V
Digital Input Voltage to AGND or DGND	0.3V, V _{DD} + 0.3V
V _{REF} to AGND or DGND	-0.3V, V _{DD} + 0.3V
V _{OUT} to AGND or DGND	V _{DD} , V _{SS}
Maximum Current into Any Pin	50mA
Continuous Power Dissipation (T _A = +70°C)	
Plastic DIP (derate 13.33mW/°C above +70°C)	733mW

Wide SO (derate 11.76mW/°C above +70°C)	647mW
Ceramic SB (derate 14.29mW/°C above +70°C)	1143mW
Operating Temperature Ranges:	
MAX526_C_G	0°C to +70°C
MAX526_E_G	-40°C to +85°C
MAX526_MYG	-55°C to +125°C
Storage Temperature Range	-65°C to +150°C
Lead Temperature (soldering, 10 sec)	+300°C

Stresses beyond those listed under "Absolute Maximum Ratings" may cause permanent damage to the device. These are stress ratings only, and functional operation of the device at these or any other conditions beyond those indicated in the operational sections of the specifications is not implied. Exposure to absolute maximum rating conditions for extended periods may affect device reliability.

ELECTRICAL CHARACTERISTICS – MAX526

(V_{DD} = +15V, V_{SS} = -5V, V_{REF} = 10V, AGND = DGND = 0V, T_A = T_{MIN} to T_{MAX}, unless otherwise noted.)

PARAMETER	SYMBOL	CONDITIONS	MIN	TYP	MAX	UNITS
STATIC PERFORMANCE – ANALOG SECTION (R_L = 5kΩ, C_L = 100pF)						
Resolution	N		±12			Bits
Total Unadjusted Error (Note 1)	TUE	MAX526C	T _A = +25°C	±1.0		LSB
		MAX526D		±2.0		
		MAX526CC		±2.0		
		MAX526DC		±3.0		
		MAX526CE		±2.5		
		MAX526DE		±3.5		
		MAX526CM		±3.0		
		MAX526DM		±4.0		
Integral Nonlinearity	INL	MAX526C	±0.15 ±0.50		LSB	
		MAX526D	±1			
Differential Nonlinearity	DNL	Guaranteed monotonic			±1	LSB
Offset Error		MAX526C	T _A = +25°C	±1.0		LSB
		MAX526D		±2.0		
		MAX526CC		±2.0		
		MAX526DC		±3.0		
		MAX526CE		±2.5		
		MAX526DE		±3.5		
		MAX526CM		±3.0		
		MAX526DM		±4.0		
Gain Error		MAX526_C/E/M, R _L = ∞	±1.0		LSB	
		MAX526_C/E	±1.5			
		MAX526_M	±2.0			
Power-Supply Rejection	ΔGain/ΔV _{DD}	V _{DD} from +10.8V to +16.5V	T _A = +25°C	±0.001	±0.01	LSB/%
	ΔGain/ΔV _{SS}	V _{SS} from -4.5V to -5.5V		±0.001	±0.01	
	ΔOffset/ΔV _{DD}	V _{DD} from +10.8V to +16.5V		±0.007	±0.075	
	ΔOffset/ΔV _{SS}	V _{SS} from -4.5V to -5.5V		±0.003	±0.03	
MATCHING PERFORMANCE						
Total Unadjusted Error (Note 1)	TUE	MAX526C	T _A = +25°C	±1.0		LSB
		MAX526D		±2.0		
Gain Error			T _A = +25°C	0.1	±1.0	LSB
Offset Error		MAX526C	T _A = +25°C	0.5	±1.0	LSB
		MAX526D		0.5	±2.0	
Integral Nonlinearity	INL		T _A = +25°C	0.2	±1.0	LSB

Calibrated Quad 12-Bit Voltage-Output D/A Converters

MAX526/MAX527

ELECTRICAL CHARACTERISTICS – MAX526 (continued)

(V_{DD} = +15V, V_{SS} = -5V, V_{REF} = 10V, AGND = DGND = 0V, T_A = T_{MIN} to T_{MAX}, unless otherwise noted.)

PARAMETER	SYMBOL	CONDITIONS	MIN	TYP	MAX	UNITS	
REFERENCE INPUT (Note 2)							
Reference Input Range	REF		0		V _{DD} - 4	V	
Reference Input Resistance	RREF		5			kΩ	
MULTIPLYING MODE PERFORMANCE							
Reference 3dB Bandwidth				700		kHz	
Reference Feedthrough		Input code = all 0s	VREF = 10Vp-p at 400HZ		-100	dB	
			VREF = 10Vp-p at 4000HZ		-82		
Total Harmonic Distortion plus Noise	THD+N	VREF = 2V _{p-p} at 50kHz		0.012		%	
DIGITAL INPUTS							
Input High Voltage	V _{INH}		2.4			V	
Input Low Voltage	V _{INL}				0.8	V	
Input Leakage Current	I _{IN}	V _{IN} = 0V or V _{DD}			1.0	μA	
Input Capacitance	C _{IN}	(Note 3)			10	pF	
DYNAMIC PERFORMANCE (R_L = 5kΩ, C_L = 100pF)							
Voltage-Output Slew Rate				5		V/μs	
Output Settling Time		To ±1/2LSB of full scale		3		μs	
Digital Feedthrough				5		nV-s	
Digital Crosstalk				5		nV-s	
POWER SUPPLIES							
Positive Supply Range	V _{DD}		10.8		16.5	V	
Negative Supply Range	V _{SS}		-4.5		-5.5	V	
Positive Supply Current	I _{DD}	(Note 4)	T _A = +25°C		11	20	mA
						28	
Negative Supply Current	I _{SS}	(Note 4)	T _A = +25°C		8	18	mA
						26	

Note 1: TUE is specified with no resistive load.

Note 2: See *Reference Input* section.

Note 3: Guaranteed by design. Not production tested.

Note 4: Digital inputs at 2.4V; with digital inputs at 0V, I_{DD} decreases typically by 1.5mA at +25°C.

TIMING CHARACTERISTICS – MAX526

(V_{DD} = +15V, V_{SS} = -5V, V_{REF} = 10V, AGND = DGND = 0V, T_A = T_{MIN} to T_{MAX}, unless otherwise noted.)

PARAMETER	SYMBOL	CONDITIONS	MIN	TYP	MAX	UNITS
CS Pulse Width	t _{CS}		100			ns
WR Pulse Width	t _{WR}		100			ns
CS to WR Setup	t _{CWS}		0			ns
CS to WR Hold	t _{CWH}		0			ns
Data Valid to WR Setup	t _{DS}		75			ns
Data to WR Hold	t _{DH}		10			ns
LDAC Pulse Width	t _{LDAC}		120			ns
Address to WR Setup	t _{AS}		25			ns
Address to WR Hold	t _{AH}		0			ns

Calibrated Quad 12-Bit Voltage-Output D/A Converters

ABSOLUTE MAXIMUM RATINGS – MAX527

V _{DD} to AGND or DGND	-0.3V, +12V	Wide SO (derate 11.76mW/°C above +70°C)	647mW
V _{SS} to AGND or DGND	-7V, to 0.3V	Ceramic SB (derate 14.29mW/°C above +70°C)	1143mW
Digital Input Voltage to AGND or DGND	0.3V, V _{DD} + 0.3V	Operating Temperature Ranges:	
V _{REF} to AGND to DGND	-0.3V, V _{DD} + 0.3V	MAX527_C_G	0°C to +70°C
V _{OUT} to AGND to DGND	V _{DD} , V _{SS}	MAX527_E_G	-40°C to +85°C
Maximum Current into Any Pin	50mA	MAX527_MYG	-55°C to +125°C
Continuous Power Dissipation (T _A = +70°C)		Storage Temperature Range	-65°C to +150°C
Plastic DIP (derate 13.33mW/°C above +70°C)	733mW	Lead Temperature (soldering, 10 sec)	+300°C

Stresses beyond those listed under "Absolute Maximum Ratings" may cause permanent damage to the device. These are stress ratings only, and functional operation of the device at these or any other conditions beyond those indicated in the operational sections of the specifications is not implied. Exposure to absolute maximum rating conditions for extended periods may affect device reliability.

ELECTRICAL CHARACTERISTICS – MAX527

(V_{DD} = +5V, V_{SS} = -5V, V_{REF} = 2.5V, AGND = DGND = 0V, T_A = T_{MIN} to T_{MAX}, unless otherwise noted.)

PARAMETER	SYMBOL	CONDITIONS	MIN	TYP	MAX	UNITS
STATIC PERFORMANCE – ANALOG SECTION (R_L = 5kΩ, C_L = 100pF)						
Resolution	N		12			Bits
Integral Nonlinearity	INL	MAX527C	±0.15	±0.50		LSB
		MAX527D		±1		
Differential Nonlinearity	DNL	Guaranteed monotonic			±1	LSB
Offset Error		MAX527C	T _A = +25°C		±3	mV
		MAX527D		±6		
		MAX527CC		±6		
		MAX527DC		±9		
		MAX527CE		±7		
		MAX527DE		±11		
		MAX527CM		±9		
		MAX527DM		±15		
Gain Error		MAX527_C/E, R _L = ∞	T _A = +25°C		±1.0	LSB
		MAX527_M, R _L = ∞		±1.0		
		MAX527_C		±2.0		
		MAX527_E		±2.5		
		MAX527_M		±3.0		
Power-Supply Rejection	ΔGain/ΔV _{DD}	V _{DD} from +4.5V to +5.5V	T _A = +25°C		±0.002 ±0.02	LSB/%
	ΔGain/ΔV _{SS}	V _{SS} from -4.5V to -5.5V		±0.002 ±0.02		
	ΔOffset/ΔV _{DD}	V _{DD} from +4.5V to +5.5V		±0.005 ±0.05		
	ΔOffset/ΔV _{SS}	V _{SS} from -4.5V to -5.5V		±0.005 ±0.05		
MATCHING PERFORMANCE						
Gain Error			T _A = +25°C	0.1	±1.0	LSB
Offset Error (Note 1)		MAX527C	T _A = +25°C	0.5	±5	LSB
		MAX527D		0.5	±10	
Integral Nonlinearity	INL		T _A = +25°C	0.2	±1.0	LSB
REFERENCE INPUT (Note 2)						
Reference Input Range	REF	Note 2	0	V _{DD} - 2.20		V
Reference Input Resistance	RREF		5			kΩ

Calibrated Quad 12-Bit Voltage-Output D/A Converters

MAX526/MAX527

ELECTRICAL CHARACTERISTICS (continued) – MAX527

(V_{DD} = +5V, V_{SS} = -5V, V_{REF} = +2.5V, AGND = DGND = 0V, T_A = T_{MIN} to T_{MAX}, unless otherwise noted.)

PARAMETER	SYMBOL	CONDITIONS	MIN	TYP	MAX	UNITS
MULTIPLYING MODE PERFORMANCE						
Reference 3dB Bandwidth				700		kHz
Reference Feedthrough		400Hz		-100		dB
		4000Hz		-82		
Total Harmonic Distortion plus Noise	THD+N	V _{REF} = 850mV _{p-p} at 100kHz		0.024		%
DIGITAL INPUTS						
Input High Voltage	V _{INH}		2.4			V
Input Low Voltage	V _{INL}				0.8	V
Input Leakage Current	I _{IN}	V _{IN} = 0V or V _{DD}			1.0	μA
Input Capacitance	C _{IN}	(Note 3)			10	pF
DYNAMIC PERFORMANCE (R_L = 5kΩ, C_L = 100pF)						
Voltage-Output Slew Rate				3		V/μs
Output Settling Time		To ±1/2LSB of full scale		5		μs
Digital Feedthrough				5		nV-s
Digital Crosstalk				5		nV-s
POWER SUPPLIES						
Positive Supply Range	V _{DD}		4.75		5.5	V
Negative Supply Range	V _{SS}		-4.5		-5.5	V
Positive Supply Current	I _{DD}	(Note 4)	T _A = +25°C	5.5	12	mA
					18	
Negative Supply Current	I _{SS}	(Note 4)	T _A = +25°C	3.6	10	mA
					16	

Note 1: TUE is specified with no resistive load.

Note 2: See *Reference Input* section.

Note 3: Guaranteed by design. Not production tested.

Note 4: Digital inputs at 2.4V.

TIMING CHARACTERISTICS – MAX527

(V_{DD} = +5V, V_{SS} = -5V, V_{REF} = +2.5V, AGND = DGND = 0V, T_A = T_{MIN} to T_{MAX}, unless otherwise noted.)

PARAMETER	SYMBOL	CONDITIONS	MIN	TYP	MAX	UNITS
CS Pulse Width	t _{CS}	MAX527_C/E	180			ns
		MAX527_M	200			
WR Pulse Width	t _{WR}	MAX527_C/E	180			ns
		MAX527_M	200			
CS to WR Setup	t _{CWS}		0			ns
CS to WR Hold	t _{CWH}		0			ns
Data Valid to WR Setup	t _{DS}		75			ns
Data to WR Hold	t _{DH}		0			ns
LDAC Pulse Width	t _{LDAC}	MAX527_C/E	120			ns
		MAX527_M	150			
Address to WR Setup	t _{AS}		25			ns
Address to WR Hold	t _{AH}		0			ns

Calibrated Quad 12-Bit Voltage-Output D/A Converters

Typical Operating Characteristics

MAX526

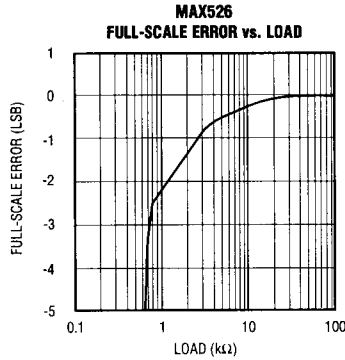
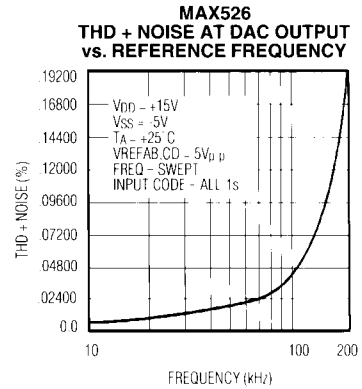
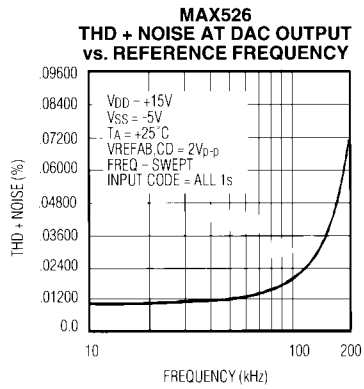
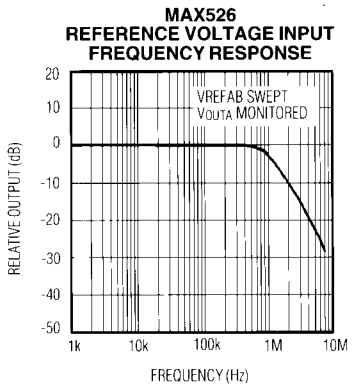
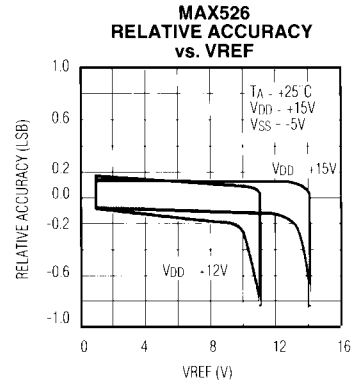
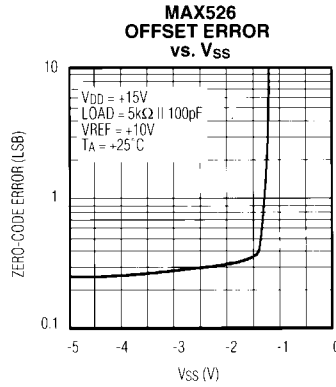
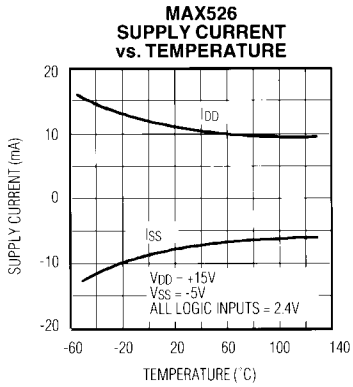

Calibrated Quad 12-Bit Voltage-Output D/A Converters

Typical Operating Characteristics (continued)

MAX526/MAX527

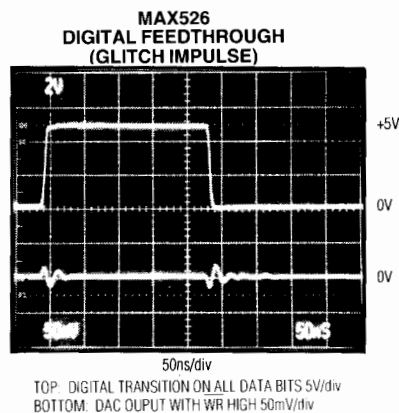
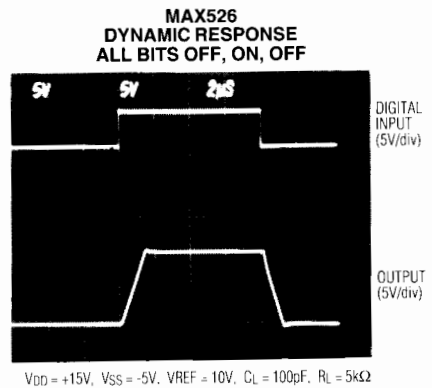
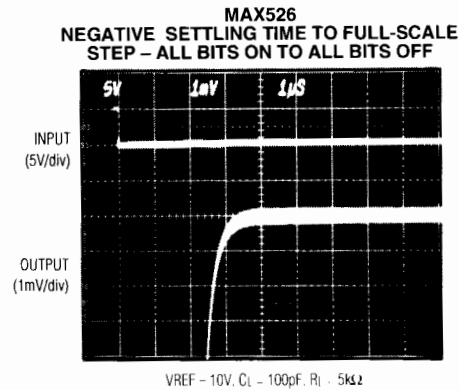
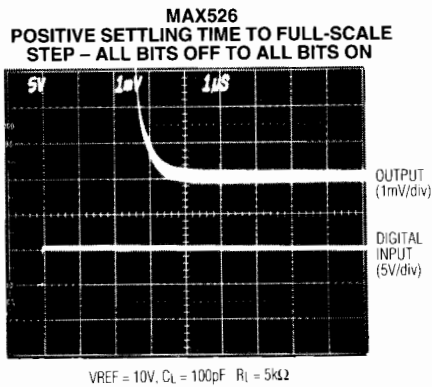
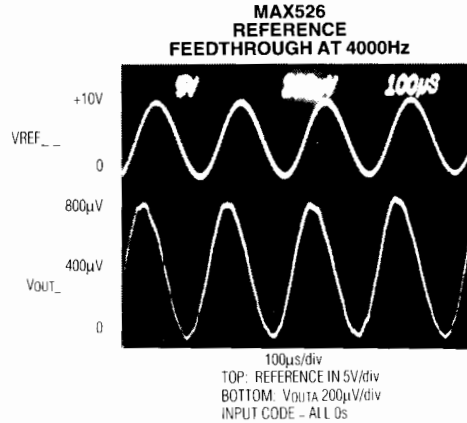
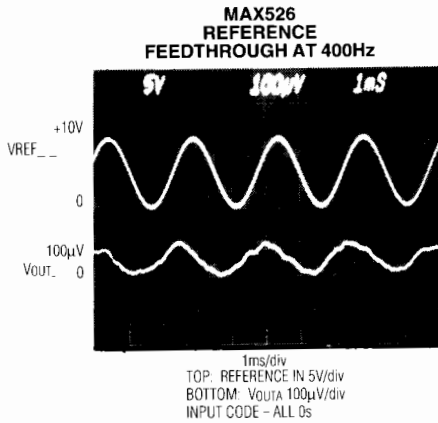

Calibrated Quad 12-Bit Voltage-Output D/A Converters

Typical Operating Characteristics

MAX527

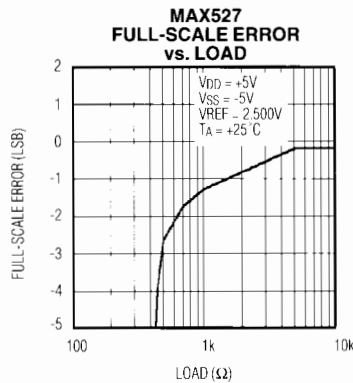
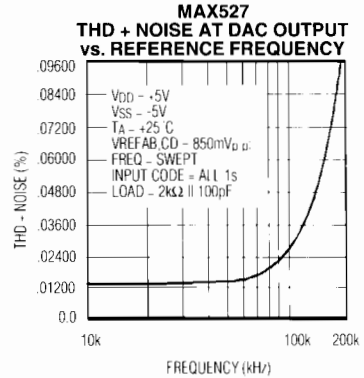
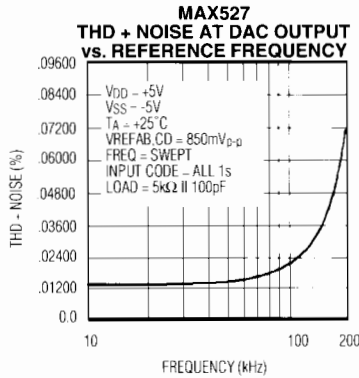
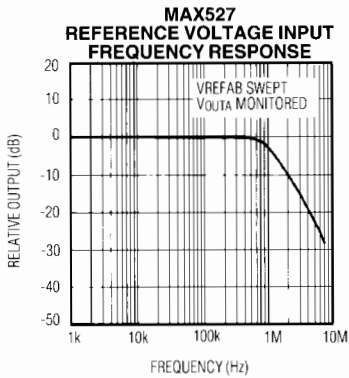
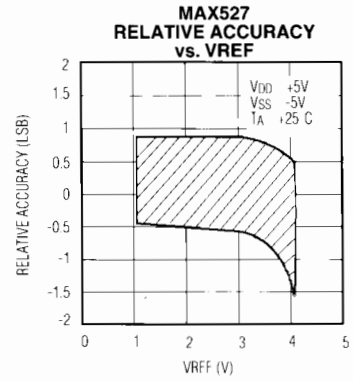
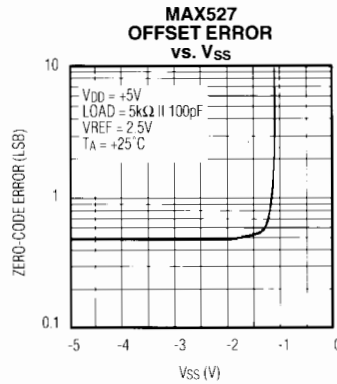
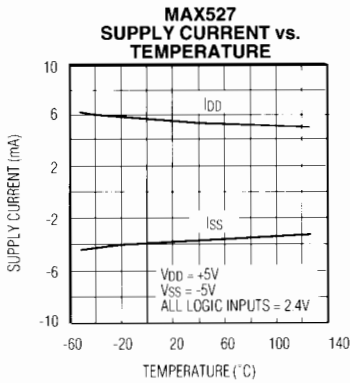

Calibrated Quad 12-Bit Voltage-Output D/A Converters

Typical Operating Characteristics (continued)

MAX526/MAX527

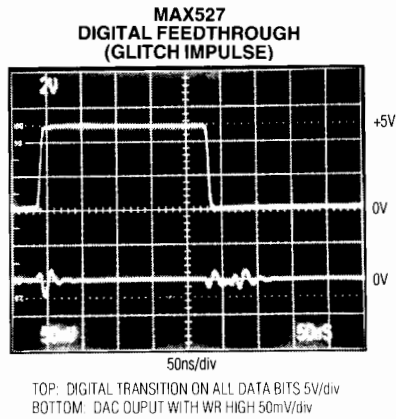
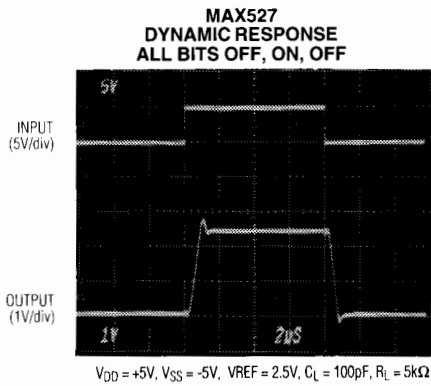
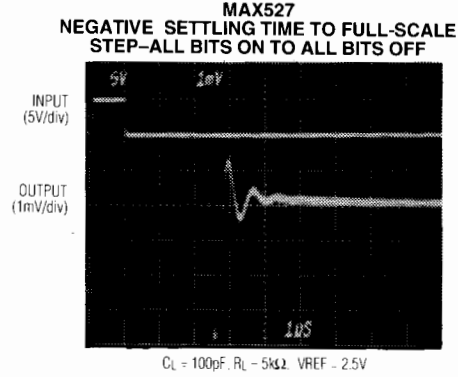
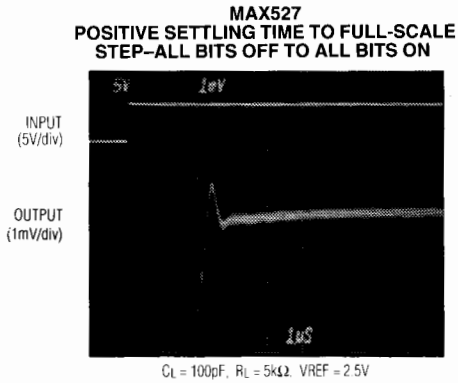
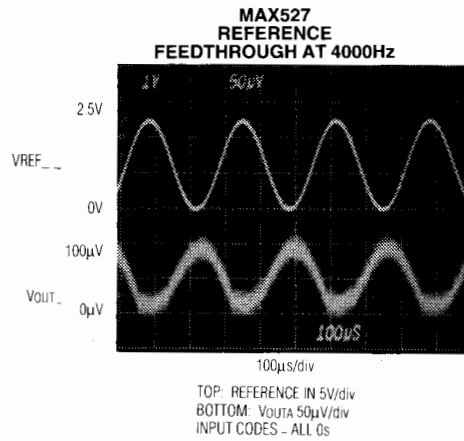
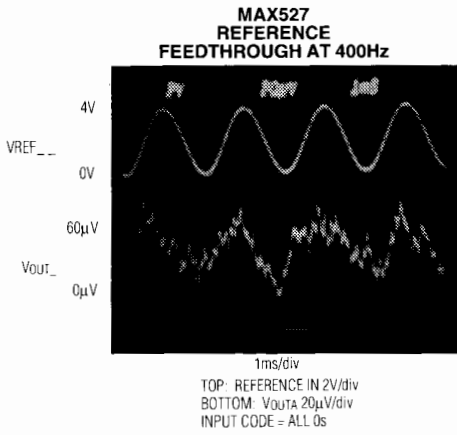

Calibrated Quad 12-Bit Voltage-Output D/A Converters

Pin Description

PIN	NAME	FUNCTION
1	VOUTC	DAC C Output Voltage
2	VOUTB	DAC B Output Voltage
3	VOUTA	DAC A Output Voltage
4	VSS	Negative Power Supply
5	AGND	Analog Ground
6	VREFAB	Reference Voltage Input for DAC A and DAC B
7	DGND	Digital Ground
8	LDAC	Load DAC Input (active low). Driving this asynchronous input low transfers the contents of each input register to its respective DAC register.
9	D7	Data Bit 7
10	D6	Data Bit 6
11	D5	Data Bit 5
12	D4	Data Bit 4
13	D11/D3	Data Bit 11 (MSB) if CSMSB is low and CSLSB is high. Data Bit 3 (MSB) if CSMSB is high and CSLSB is low.
14	D10/D2	Data Bit 10 (MSB) if CSMSB is low and CSLSB is high. Data Bit 2 (MSB) if CSMSB is high and CSLSB is low.
15	D9//D1	Data Bit 9 (MSB) if CSMSB is low and CSLSB is high. Data Bit 1 (MSB) if CSMSB is high and CSLSB is low.
16	D8/D0	Data Bit 8 (MSB) if CSMSB is low and CSLSB is high. Data Bit 0 (MSB) if CSMSB is high and CSLSB is low.
17	A1	DAC Address Select Bit (MSB)
18	A0	DAC Address Select Bit (LSB)
19	VREFCD	Reference Voltage Input for DAC C and DAC D
20	WR	Write Input (active low). WR along with CSMSB and CSLSB load data into the DAC input register selected by A1 and A0.
21	CSLSB	Chip Select for LS Byte (active low). Selects the lower 8 bits of the addressed input register.
22	CSMSB	Chip Select for MS Nibble (active low). Selects the upper 4 bits of the addressed input register.
23	VDD	Positive Supply Voltage
24	VOUTD	DAC D Output Voltage

Detailed Description

Analog Section

The MAX526/MAX527 contain four voltage output DACs. The DACs are "inverted" R-2R ladder networks that convert 12-bit digital inputs into equivalent analog output voltages in proportion to the applied reference voltages. The MAX526/MAX527 have two reference inputs: one shared by DAC A and DAC B (VREFAB), and the other shared by DAC C and DAC D (VREFCD). These inputs allow different full-scale output voltage ranges for each pair of DACs (Figure 1).

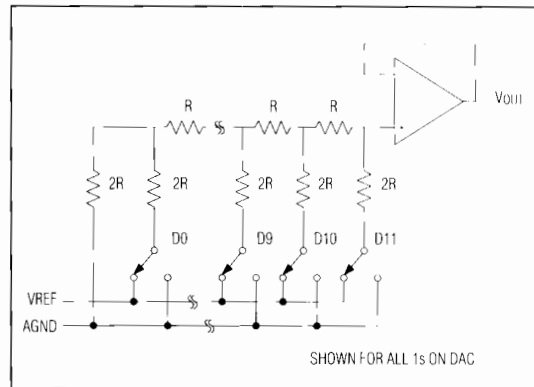

Figure 1. Simplified DAC Circuit Diagram

Reference Input

The MAX526/MAX527 can be used for multiplying applications. The reference accepts both DC and AC signals. The voltage at each VREF input sets the full-scale output voltages for its respective DACs. The input impedance of the VREF inputs are code dependent, with the lowest value (typically 6kΩ for VREFAB or VREFCD) occurring when the input code is 0101 0101 0101. The maximum value, typically 60kΩ, occurs when the input code is 0000 0000 0000. Since the input impedance at VREF is code dependent, load regulation of the reference used is important.

Calibrated Quad 12-Bit Voltage-Output D/A Converters

The guaranteed minimum input impedance of each reference input of the MAX526/MAX527 is 5kΩ. When the reference inputs are driven from the same source, the minimum impedance that must be driven by the reference source is 2.5kΩ. A voltage reference such as the MAX674 would typically deviate by 0.165LSB (0.33LSB worst case) when simultaneously driving both MAX526 reference inputs at 10V. Improve accuracy by driving VREFAB and VREFCD separately or by using a reference with excellent accuracy and superior load regulation, such as the MAX676/MAX677/MAX678.

Using an op amp to buffer the reference is another way to obtain high accuracy. The closed-loop output impedance of the op amp should be kept below 0.05Ω. This ensures errors of less than 0.08LSB when driving both reference inputs simultaneously. The MAX400 or OP07 are suitable for this application. The input capacitance at VREF is also code dependent and typically varies from 125pF to 300pF.

VOUTA-D are represented by a digitally programmable voltage source as:

$$V_{OUT} = (N_B \times VREF) / 4096$$

where N_B is the numeric value of the DAC's binary input code (0 to 4095).

Output Buffer Amplifiers

All MAX526/MAX527 voltage outputs are internally buffered by precision unity-gain followers with a typical slew rate of 5V/μs for the MAX526 and 3V/μs for the MAX527.

With a full-scale transition at the MAX526 output (0V to +10V or +10V to 0V), the typical settling time to ±1/2LSB is 3μs when loaded with 5kΩ in parallel with 100pF (loads less than 5kΩ degrade performance). Typical output dynamic response and settling performance of the MAX526 output amplifier are shown in the *Typical Operating Characteristics* section.

With a full-scale transition at the MAX527 output (0V to +2.5V or +2.5V to 0V), the typical settling time to ±1/2LSB is 5μs when loaded with 5kΩ in parallel with 100pF (loads less than 5kΩ degrade performance). Typical output dynamic response and settling performance of the MAX527 output amplifiers are shown in the *Typical Operating Characteristics* section.

Digital Inputs and Interface Logic

Digital inputs are compatible with both TTL and 5V CMOS logic. The MAX526/MAX527 interface with microprocessors using an 8-bit-wide data bus. The double-buffered input structure consists of a 12-bit (8 + 4) input register and a 12-bit DAC register for each of the four DACs.

Each DAC's analog output reflects the data held in its DAC register. Address lines A0 and A1 select which DAC receives data from the data bus, as shown in Table 1. All MAX526/MAX527 control inputs are level-triggered. Figure 2 shows the MAX526/MAX527 input control logic.

Table 1. DAC Addressing

A1	A0	SELECTED INPUT REGISTER
L	L	DAC A Input Register
L	H	DAC B Input Register
H	L	DAC C Input Register
H	H	DAC D Input Register

CSMSB, CSLSB, and WR load from the data bus to the input register selected by A0 and A1. Pulling CSLSB and WR low loads the lower 8 bits of the input register, while CSMSB and WR load the upper 4 bits. The order in which the data is loaded into the input register (i.e. upper 4 bits first or lower 8 bits first) is not important. It is possible to concurrently load the full 12 bits of the input register by pulling CSLSB, CSMSB, and WR low. Note that the same data will be written to the 4MSBs (D11-D8) and the 4LSBs (D3-D0), respectively. If the DACs are configured in the unipolar output mode (see Figure 5 and Table 3), this method can be used to quickly zero the DAC outputs.

Data is latched into the selected input register on the rising edge of WR. Alternatively, data will be latched into

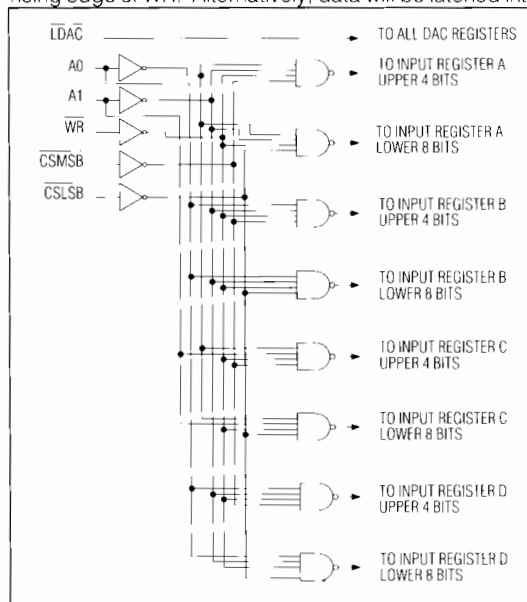

Figure 2. Input Control Logic

Calibrated Quad 12-Bit Voltage-Output D/A Converters

Table 2. Write-Cycle Truth Table

CSLSB	CSMSB	WR	LDAC	FUNCTION
L	H	L	H	Loads LS byte into selected input register
L	H	\bar{L}	H	Latches LS byte into selected input register
\bar{L}	H	L	H	Latches LS byte into selected input register
H	L	L	H	Loads MS nibble into selected input register
H	L	\bar{L}	H	Latches MS nibble into selected input register
H	\bar{L}	L	H	Latches MS nibble into selected input register
X	X	H	L	Transfers data from input registers into DAC registers. DAC outputs reflect data held in their respective input registers
X	X	H	\bar{L}	Latches the four DAC registers. Input registers cannot be written to.
H	L	L	L	Loads MS nibble into selected input register and loads input registers into DAC registers.
\bar{L}	X	H	H	No operation. Device is not selected.
L	L	L	L	Loads all 12 bits of selected input register. Transfers data from input registers into DAC registers. DAC outputs reflect data held in their respective input registers.
L	L	L	H	Loads all 12 bits into selected input register.
L	H	L	L	Loads LS byte into selected input register. Transfers data from input registers into DAC registers. DAC outputs reflect data held in their respective input registers.
H	H	L	L	Transfers data from input registers into DAC registers. DAC outputs reflect data held in their respective input registers.
H	H	L	H	No operation

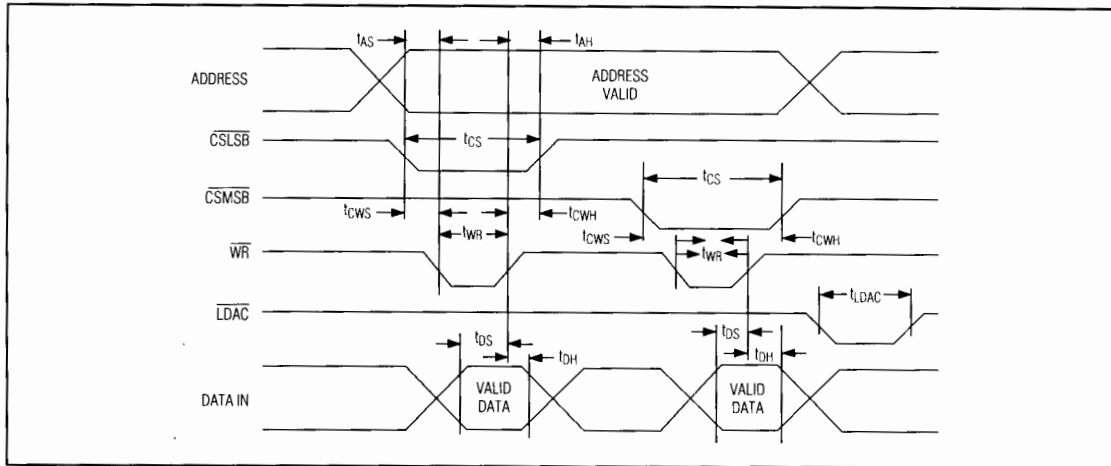

Figure 3. Write-Cycle Timing

Calibrated Quad 12-Bit Voltage-Output D/A Converters

MAX526/MAX527

the lower 8 bits of the input register on the rising edge of CSLSB, and the upper 4 bits will be latched on the rising edge of CSMSB.

Data is transferred from all input registers to the DAC registers by pulling LDAC low. This simultaneously updates all four DACs. Since LDAC is asynchronous with respect to WR, be sure that incorrect data is not latched to the output. Table 2 shows the truth table for operation of WR, LDAC, CSLSB, and CSMSB. Figure 3 shows the MAX526/MAX527 write-cycle timing.

Application Information

Ground Management

Digital or AC transient signals between AGND and DGND can create noise at the analog outputs. It is recommended that AGND and DGND be tied together at the DAC and that this point be tied to the highest quality ground available. If separate ground buses are used, two clamp diodes (1N914 or equivalent) should be connected in inverse parallel between AGND and DGND. This will ensure that the two ground pins always remain within one diode drop of each other.

Careful PCB ground layout minimizes crosstalk between DAC outputs, reference inputs, and digital inputs. Figure 4 shows a suggested circuit-board layout for minimizing crosstalk.

Unipolar Output

In unipolar operation, the output voltages and the reference inputs are the same polarity. Figure 5 shows the MAX526/MAX527 unipolar output circuit. The unipolar output codes are listed in Table 3.

Table 3. Unipolar Code Table

DAC CONTENTS		ANALOG OUTPUT
MSB	LSB	
1111	1111 1111	$+VREF \left(\frac{4095}{4096} \right)$
1000	0000 0001	$+VREF \left(\frac{2049}{4096} \right)$
1000	0000 0000	$+VREF \left(\frac{2048}{4096} \right) = \frac{+VREF}{2}$
0111	1111 1111	$+VREF \left(\frac{2047}{4096} \right)$
0000	0000 0001	$+VREF \left(\frac{1}{4096} \right)$
0000	0000 0000	0V

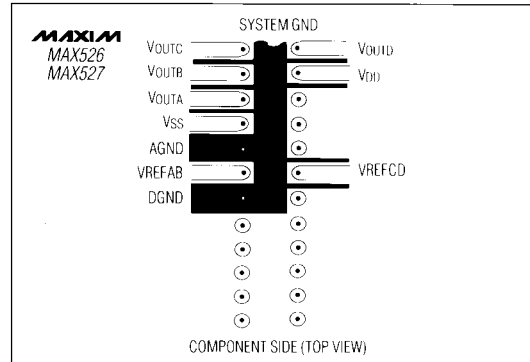

Figure 4. Suggested PCB Layout for Minimizing Crosstalk

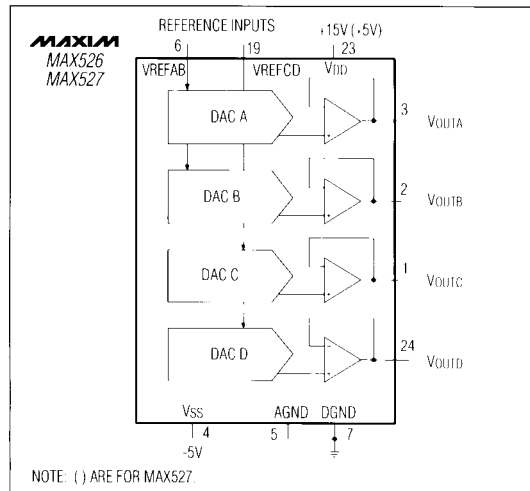

Figure 5. Unipolar Output Circuit

Bipolar Output

The MAX526/MAX527 outputs may be configured for bipolar output operation using Figure 6's circuit. One op amp and two resistors are required per channel. With $R1 = R2$:

$$V_{OUT} = VREF \left(\frac{2N_B}{4096} - 1 \right)$$

where N_B is the numeric value of the DAC's binary input code.

Table 4 shows the digital code vs. output voltage for the circuit in Figure 6.

Calibrated Quad 12-Bit Voltage-Output D/A Converters

Using an AC Reference

In applications where VREF has AC signal components, the MAX526/MAX527 have multiplying capability within the VREF input range specifications. Figure 7 shows a technique for applying a sine wave signal to the reference input where the AC signal is offset before being applied to VREF. Note that VREF must never be more negative than DGND.

Total harmonic distortion plus noise (THD + N) of the MAX526 is typically less than 0.012% with input frequencies up to 35kHz for 5V_{p-p} swing; up to 50kHz for 2V swing. The typical -3dB frequency is 700kHz, as shown in the *Typical Operating Characteristics* graphs.

For the MAX527, THD + N is typically less than 0.024% with input frequencies up to 100kHz, a signal amplitude of 850mV, and a load of 5kΩ in parallel with 100pF. With a 2kΩ load in parallel with 100pF, the MAX527's THD is below 0.024% for input frequencies up to 95kHz.

Table 4. Bipolar Code Table

DAC CONTENTS		ANALOG OUTPUT
MSB	LSB	
1111	1111 1111	$+VREF \left(\frac{2047}{2048} \right)$
1000	0000 0001	$+VREF \left(\frac{1}{2048} \right)$
1000	0000 0000	0V
0111	1111 1111	$-VREF \left(\frac{1}{2048} \right)$
0000	0000 0001	$-VREF \left(\frac{2047}{2048} \right)$
0000	0000 0000	$-VREF \left(\frac{2048}{2048} \right) = -VREF$

NOTE: 1LSB = $(VREF) \left(\frac{1}{4096} \right)$

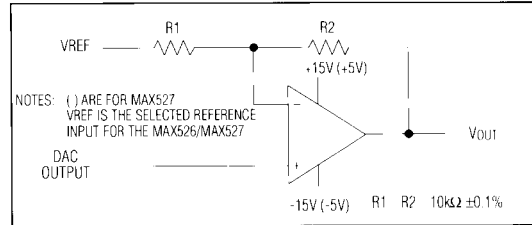

Figure 6. Bipolar Output Circuit

Offsetting AGND

AGND can be biased above DGND to provide an arbitrary nonzero output voltage for a "0" input code. This application is shown in Figure 8. The output voltage at VOUTA is:

$$V_{OUTA} = V_{BIAS} + N_B \times V_{IN}$$

where N_B is the numeric value of the DAC's binary input code. Since AGND is common to all four DACs, all outputs will be offset by V_{BIAS} in the same manner. Note that AGND should not be biased more negative than DGND.

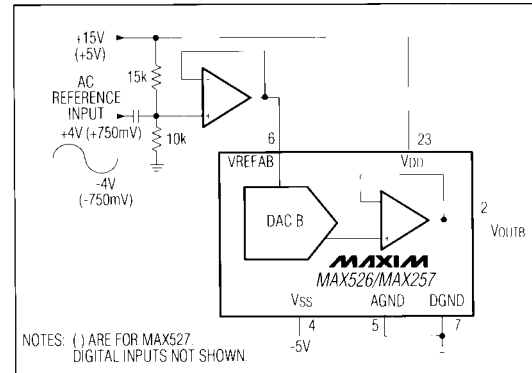

Figure 7. AC Reference Input Circuit

Calibrated Quad 12-Bit Voltage-Output D/A Converters

MAX526/MAX527

Supply Voltage and Decoupling

For full MAX526 performance, V_{DD} should be 4V higher than V_{REF} in the 10.8V to 16.5V range. When using the MAX527, V_{DD} should be at least 2.2V higher than V_{REF} in the 4.75V to 5.5V range. Both V_{DD} and V_{SS} supplies should be bypassed with a 4.7 μ F capacitor in parallel with a 0.1 μ F capacitor to AGND, with short lead lengths as close to the supply pins as possible.

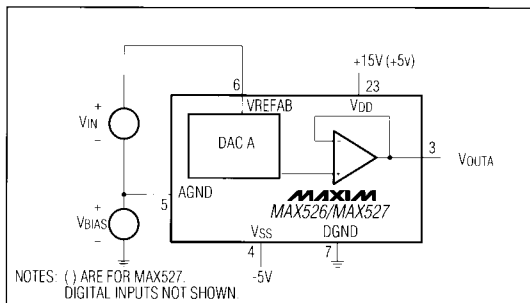

Figure 8. AGND Bias Circuit

Power-Supply Sequencing

On power-up, V_{SS} should come up first, V_{DD} next, followed by V_{REFAB} or V_{REFCD} . If supply sequencing is not possible, tie an external Schottky diode between V_{SS} and AGND as shown in Figure 9.

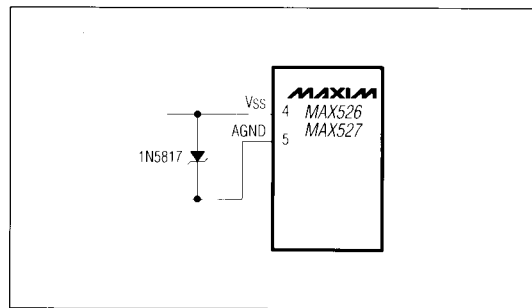

Figure 9. When V_{SS} and V_{DD} cannot be sequenced, tie a Schottky diode between V_{SS} and AGND.

Calibrated Quad 12-Bit Voltage-Output D/A Converters

Ordering Information (continued)

PART	TEMP. RANGE	PIN-PACKAGE	INL (LSBs)
MAX527CCNG	0°C to +70°C	24 Narrow Plastic DIP	± 1/2
MAX527DCNG	0°C to +70°C	24 Narrow Plastic DIP	± 1
MAX527CCWG	0°C to +70°C	24 Wide SO	± 1/2
MAX527DCWG	0°C to +70°C	24 Wide SO	± 1
MAX527DC/D	0°C to +70°C	Dice*	± 1
MAX527CENG	-40°C to +85°C	24 Narrow Plastic DIP	± 1/2
MAX527DENG	-40°C to +85°C	24 Narrow Plastic DIP	± 1
MAX527CEWG	-40°C to +85°C	24 Wide SO	± 1/2
MAX527DEWG	-40°C to +85°C	24 Wide SO	± 1
MAX527CMYG	-55°C to +125°C	24 Narrow Ceramic SB**	± 1/2
MAX527DMYG	-55°C to +125°C	24 Narrow Ceramic SB**	± 1

* Contact factory for dice specifications.

** Contact factory for availability and processing to MIL-STD-883.

Chip Topography

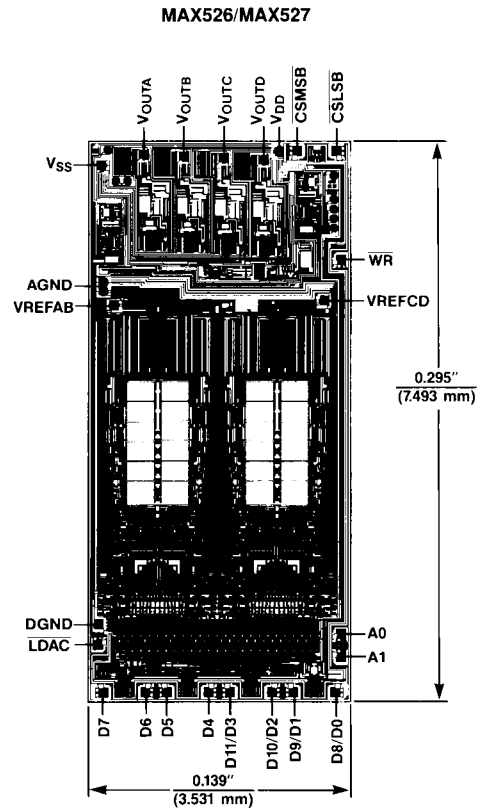

SUBSTRATE CONNECTS TO V_{DD};
TRANSISTOR COUNT: 2720.

Maxim cannot assume responsibility for use of any circuitry other than circuitry entirely embodied in a Maxim product. No circuit patent licenses are implied. Maxim reserves the right to change the circuitry and specifications without notice at any time.

16 **Maxim Integrated Products, 120 San Gabriel Drive, Sunnyvale, CA 94086 (408) 737-7600**

X-ON Electronics

Largest Supplier of Electrical and Electronic Components

Click to view similar products for [Digital to Analog Converters - DAC category](#):

Click to view products by [Maxim manufacturer](#):

Other Similar products are found below :

[5962-8876601LA](#) [PM7545FPCZ](#) [AD5311BRMZ-REEL7](#) [AD664AJ](#) [AD7534JPZ](#) [TCC-103A-RT](#) [057536E](#) [5962-89657023A](#) [702423BB](#)
[TCC-202A-RT](#) [AD664BE](#) [TCC-303A-RT](#) [TCC-206A-RT](#) [AD5770RBCBZ-RL7](#) [DAC8229FSZ-REEL](#) [AD5673RBCPZ-2](#) [MCP48FVB24-20E/ST](#) [MCP48FVB28-E/MQ](#) [MCP48FEB18-20E/ST](#) [MCP48FEB18-E/MQ](#) [MCP48FEB24-E/MQ](#) [MCP48FEB28T-20E/ST](#)
[MCP47FVB04T-E/MQ](#) [MCP48FEB28T-E/MQ](#) [MCP48FVB28T-20E/ST](#) [MCP47FVB28T-20E/ST](#) [MCP47FEB24T-E/MQ](#) [MCP48FVB18T-20E/ST](#) [MCP47FEB14T-E/MQ](#) [MCP47FEB08T-E/MQ](#) [MCP48FVB08T-20E/ST](#) [MCP47FEB04T-E/MQ](#) [MCP47FVB04T-20E/ST](#)
[AD7524JRZ-REEL](#) [LTC1664CGN](#) [LTC1664IGN](#) [LTC7545ACSW](#) [MCP47DA1T-A1E/OT](#) [MCP4921-E/MC](#) [UC3910D](#) [DAC39J84IAAV](#)
[DAC8218SPAG](#) [DAC8562TDGSR](#) [MAX545BCPD+](#) [DAC7641YB/250](#) [DAC7611PB](#) [DAC0800LCM](#) [TLV5638CDR](#) [TLC5615IDR](#)
[DAC900TPWRQ1](#)