

MAX5717 Evaluation Kit

Evaluates: MAX5717/MAX5719

General Description

The MAX5717/MAX5719 evaluation kit (EV kit) demonstrates the MAX5717/MAX5719, 16/20-bit DAC. The EV kit includes a graphical user interface (GUI) that provides communication over SPI with an on-board master IC.

The MAX5717 EV kit comes with the MAX5717GSD+ installed and the MAX5719 comes with the MAX5719GSD+ installed.

Features

- On-Board SPI Controller
- On-Board Output Buffer (MAX9632)
- On-Board +4.096V Reference Voltage (MAX6126)
- Windows XP®, Windows® 7/8/8.1/10-Compatible Software

Board Photo

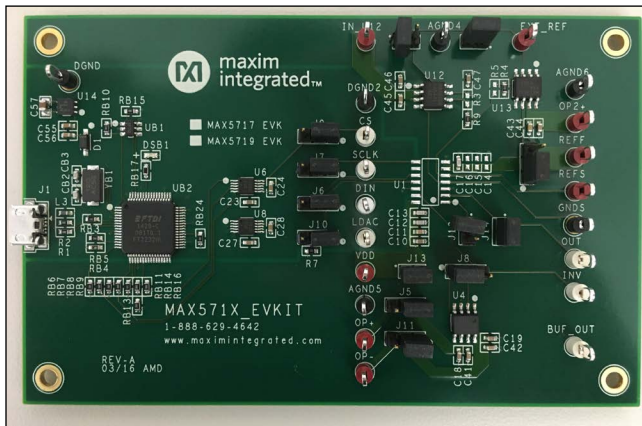

Quick Start

Required Equipment

- MAX5717/MAX5719 EV kit (includes micro-USB cable)
- Windows PC
- Digital Oscilloscope

Note: In the following sections, software-related items are identified by bolding. Text in bold refers to items directly from the EV kit software. Text in **bold and underlined** refers to items from the Windows operating system.

Procedure

The EV kit is fully assembled and tested. Follow the steps below to verify board operation:

- 1) Visit [HERE](#) to download the latest version of the EV kit software, *5717EVKit.ZIP*. Save the EV kit software to a temporary folder and uncompress the ZIP file.
- 2) Verify that all jumpers on the EV kit are in their default positions, as shown in [Table 1](#).
- 3) Connect a probe from the oscilloscope at the OUT test point.
- 4) Connect the USB cable from the PC to the MAX5717/MAX5719 EV kit board.
- 5) Open the EV kit GUI, *MAX5717EVKit.exe* and select **Device->MAX5717PMB** option (or MAX5719PMB).
- 6) Click the **Scan Adapters** button. Then select the option **PMODxxxxxx** (where xxxxxx is numeric) and click the **Connect** button. See [Figure 1](#) and [Figure 2](#).
- 7) Click the **Sample Once** button and verify the oscilloscope waveform form matches that of the GUI.

Ordering Information appears at end of data sheet.

Windows is a registered trademark and registered service mark of Microsoft Corporation.

Windows XP is a registered trademark and registered service mark of Microsoft Corporation.

Table 1. Jumper Descriptions

JUMPER	SHUNT POSITION	DESCRIPTION
J2	Installed	Used for a buffered reference voltage. Connects the output voltage from the MAX6126 to the input of the MAX9632.
	Not installed*	Disconnects the output voltage from the MAX6126 to the input of the MAX9632.
J3	Installed*	Powers the MAX6126 using USB supply.
	Not installed	Disconnects the USB supply from the MAX6126. User must apply 5V at the IN_U12 test point to use the MAX6126.
J4	1-2*	Connects the output voltage from the MAX6126.
	2-3	User-Supplied Voltage Reference. Connects to the MAX9632 output. User must apply voltage reference at the EXT_REF test point and 5V at the OP2+ test point to power the MAX9632 (U13).
J5	1-2*	Powers the MAX9632's V _{CC} pin using USB supply.
	2-3	User-supplied power to the MAX9632 (U4). Apply 5V to 15V at the OP+ test point. Recommended for use in bipolar mode.
J6	1-2*	DIN from on-board master.
	2-3	User-supplied DIN. Apply respective signal at DIN test point.
J7	1-2*	SCLK from on-board master.
	2-3	User-supplied SCLK. Apply respective signal at SCLK test point.
J8	1-2*	Connects the negative input to the output of the MAX9632.
	2-3	Connects the MAX5717/MAX5719's INV pin to the negative input of the MAX9632.
J9	1-2*	CS from on-board master.
	2-3	User-Supplied CS. Apply respective signal at CS test point.
J10	1-2*	LDAC from On-Board Master.
	2-3	User-Supplied LDAC. Apply respective signal at LDAC test point.
J11	1-2	Do Not Use
	2-3*	User-Supplied Power to the MAX9632 (U4). Apply -5V to -15V at the OP- test point. Recommended for use in bipolar mode.
J12	Installed*	Connects the MAX5717/MAX5719's RFB pin to the MAX9632's output.
	Not installed	Disconnects the MAX5717/MAX5719's RFB pin to the MAX9632's output.
J13	Installed*	Powers the MAX5717/MAX5719 using the USB power.
	Not installed	User-supplied power. Apply 5V at the V _{DD} test point.
J14	Installed*	Connects the MAX5717/MAX5719's OUT pin to the MAX9632's IN+ pin.
	Not installed	Disconnects the MAX5717/MAX5719's OUT pin to the MAX9632's IN+ pin.

*Default position.

General Description of Software

The main window of the MAX5717/MAX5719 EV kit software contains controls to evaluate the MAX5717 and MAX5719 ICs. Included is a waveform generator that allows the user to quickly evaluate the device.

USB2PMB Adapter

The controls within the **USB2PMB** groupbox allow the user to select the appropriate USB2PMB devices. When **Scan Adapters** button is pressed, it will update the dropdown list with all USB2PMB devices. With the EV kit connected to the PC, **PMODxxxxxx** (where xxxxxx is numeric) will appear within the dropdown list. Make the appropriate selection respective of the IC and press on the **Connect** button.

Sample

The Sample groupbox contains the sample rate and SPI SCLK options applicable to EV kit. Sample rate ranges from 5000sps to 20000sps. The SPI SCLK is selectable from 80kHz to 15MHz. Once configured, the user can either press the Sample Once or Sample Continuous button.

Transfer Function

The EV kit can work in either unipolar or bipolar mode. Please refer to Unipolar and Bipolar section of the data sheet.

Plot Configuration

The Scope display can plot the waveform generator's data in units of LSBs or voltage in a time domain. In addition, provides an FFT plot of the raw data for the MAX5717 or MAX5719.

Signal Setup

The **Signal Setup** controls are similar to a function generator and can be used to quickly evaluate the EV kit. It provides waveforms in sine, left and right sawtooth, triangle, square, and white noise. Amplitude, Offset, and Frequency can be adjusted for each waveform.

General Description of Hardware

The MAX5717/MAX5719 EV kit demonstrates the MAX5717/MAX5719, 16/20-bit DAC. The EV kit includes an on-board master IC for all SPI and I/O communication.

User-Supplied SPI

To evaluate the EV kit with a user-supplied SPI bus, place shunts on the 2-3 position of jumper J6, J7, J9, and J10. Apply the user-supplied SPI signals to the SCLK, CS, DIN, and LDAC test points. Make sure the return ground is the same as the MAX5717/MAX5719's ground.

User-Supplied V_{DD}

The MAX5717/MAX5719 is powered through USB by default. For user-supplied V_{DD}, remove the shunt of the jumper J13 and apply +5V at the V_{DD} test point.

User-Supplied Power for Voltage Reference (U12)

The voltage reference is powered through USB by default. For user-supplied power, remove the shunt of the jumper J3 and apply +5V at the IN_U12 test point.

User-Supplied Voltage Reference

The MAX9632 (U13) is an optional buffer for the reference of the MAX5717/MAX5719. Apply only +5V to the OP2+ test point when a voltage reference is applied at the EXT_REF test point.

User-Supplied Power for Buffer (U4)

The MAX9632 is an optional buffer for the output of the MAX5717/MAX5719. Place shunts on the 2-3 position of jumpers J5 and J11. Apply only +5V to +15V at the OP+ test point and -5V to -15V at the OP- test point.

Unipolar and Bipolar Output

When in unipolar output and the output buffer is in use, a shunt should be placed in the 2-3 position of jumper J5, 1-2 position of the jumper J8, 2-3 position of jumper J11, and open position of jumper 12. When in bipolar output, a shunt should be placed in the 2-3 position of jumper J5, 2-3 position of the jumper J8, 2-3 position of jumper J11, and closed position of jumper J12.

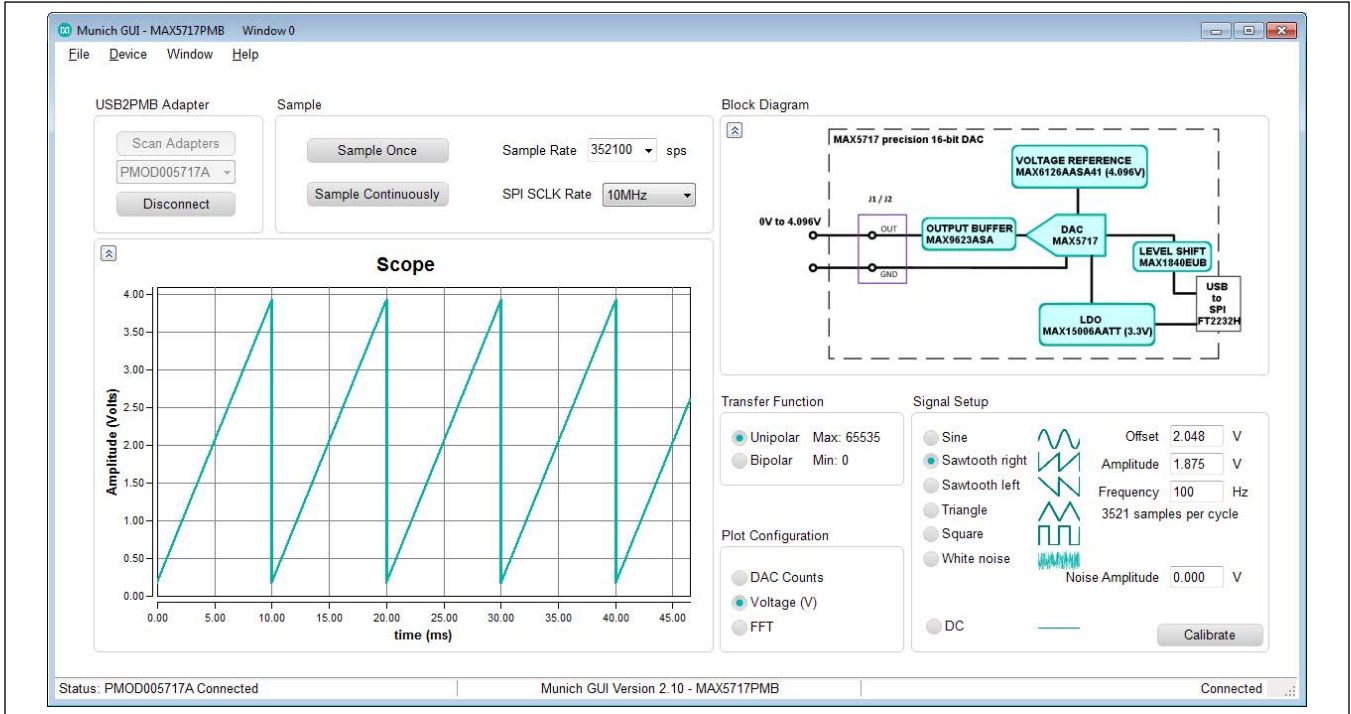

Figure 1. MAX5717 EV Kit Main Window

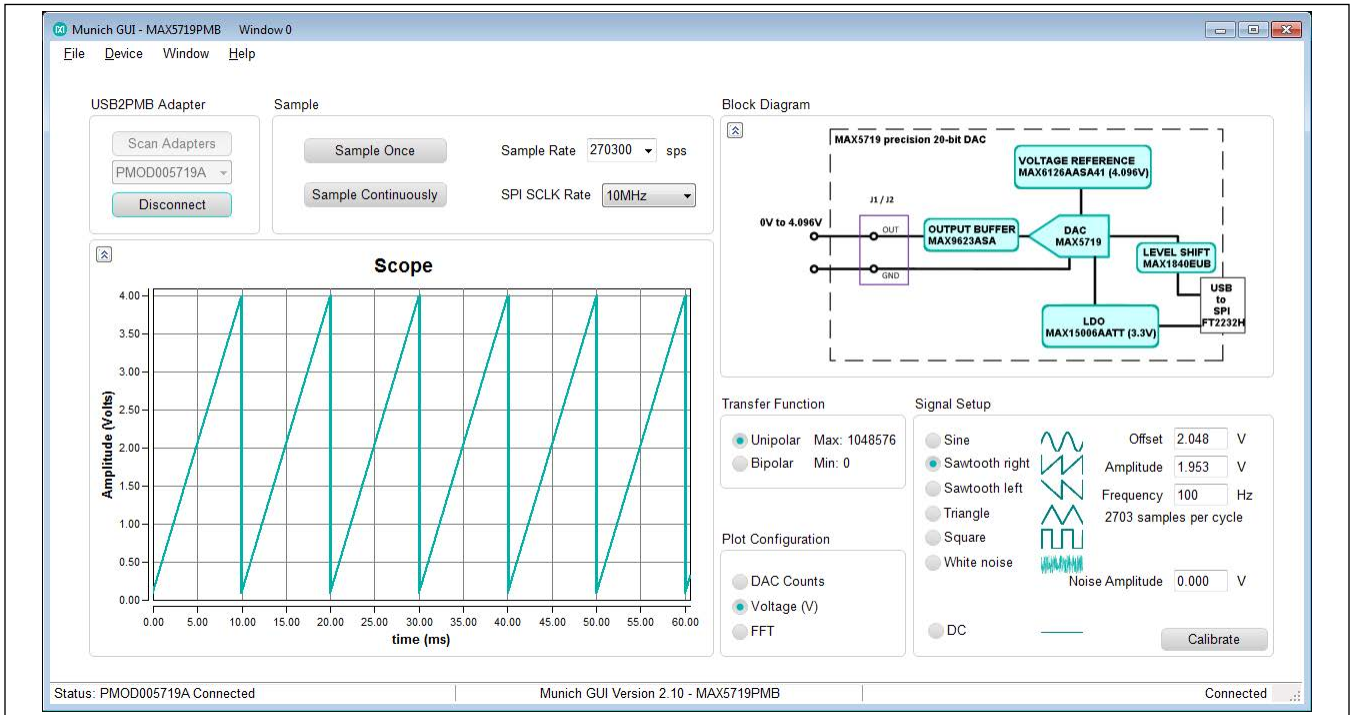

Figure 2. MAX5719 EV Kit Main Window

Component Information, PCB Layout, and Schematics

See the following links for component information, PCB layout diagrams, and schematic.

- [MAX5717/MAX5719 EV BOM](#)
- [MAX5717/MAX5719 EV PCB Layout](#)
- [MAX5717/MAX5719 EV Schematic](#)

Ordering Information

Part	TYPE
MAX5717EVKIT#	EV KIT
MAX5719EVKIT#	EV KIT

#Denotes RoHS compliant.

Revision History

REVISION NUMBER	REVISION DATE	DESCRIPTION	PAGES CHANGED
0	6/16	Initial Release	—

For pricing, delivery, and ordering information, please contact Maxim Direct at 1-888-629-4642, or visit Maxim Integrated's website at www.maximintegrated.com.

Maxim Integrated cannot assume responsibility for use of any circuitry other than circuitry entirely embodied in a Maxim Integrated product. No circuit patent licenses are implied. Maxim Integrated reserves the right to change the circuitry and specifications without notice at any time.

TITLE: Bill of Materials

DATE: 03/03/2016

DESIGN: max571x_evkit_a

VARIANT:dni

ITEM	QTY	REF DES	MFG PART #	MANUFACTURER	VALUE	DESCRIPTION
1	3	AGND4-AGND6	5011 ?		5011	TEST POINT; PIN DIA=0.125IN; TOTAL LENGTH=0.445IN; BOARD HOLE=0.063IN; BLACK PLATE FINISH; RECOMMENDED FOR BOARD THICKNESS=0.062IN
2	7	CS, DIN, INV, OUT, LDAC, SCLK, BUF_OUT	5012 ?		5012	TEST POINT; PIN DIA=0.125IN; TOTAL LENGTH=0.445IN; BOARD HOLE=0.063IN; WHITE PLATE FINISH; RECOMMENDED FOR BOARD THICKNESS=0.062IN
3	10	C1, C3, C5-C7, C21, C22, C29, C30, C56	C0603C104K3 RAC; GRM188R71E 104KA01; C1608X7R1E1 04K	KEMET/MURATA/T DK	0.1UF	CAPACITOR; SMT; 0603; CERAMIC; 0.1uF; 25V; 10%; X7R; -55degC to + 125degC; +/-10% TOL; RECOMMENDED FOR NEW DESIGN USE - 20-000u1-01
4	3	C2, C4, C20	GRM21BR61E 475KA	MURATA	4.7UF	CAPACITOR; SMT (0805); CERAMIC CHIP; 4.7UF; 25V; TOL=10%; MODEL=X5R; TG=-55
5	7	C10, C18, C19, C44- C47	C0603C104K4 RAC; GCM188R71C 104KA37; C1608X7R1C1 04K; GRM188R71C 104K; C0603X7R160- 104KNE	KEMET/MURATA/T DK/VENKEL LTD.	0.1UF	CAPACITOR; SMT (0603); CERAMIC CHIP; 0.1UF; 16V; TOL=10%; TG=-55 DEGC TO +125 DEG C; RECOMMENDED FOR NEW DESIGN USE 20-000u1-01
6	1	C11	C0603C103K5 RAC; GRM188R71H 103K;C0603X7 R500-103KNE	KEMET/MURATA/V ENKEL LTD.	0.01UF	CAPACITOR; SMT; 0603; CERAMIC; 0.01uF; 50V; 10%; X7R; -55degC to + 125degC; US
7	1	C12	C0603C102K5 RAC; GRM188R71H 102KA01; C0603X7R500- 102KNE	KEMET/MURATA/V ENKEL	1000PF	CAPACITOR; SMT; 0603; CERAMIC; 1000pF; 50V; 10%; X7R; -55degC to + 125degC; +/-10% TOL; RECOMMENDED FOR NEW DESIGN 20-1000p-E4 FOR NEW DESIGN

8	2	C13, C17	C0603C0G500-181JNE; GRM1885C1H181J	VENKEL LTD./MURATA	180PF	CAPACITOR; SMT (0603); CERAMIC CHIP; 180PF; 50V; TOL=5%; MODEL=; TG=-55 DEG
9	7	C23, C24, C27, C28, C41-C43	C0603X5R160-105KNP; EMK107BJ105KA; C1608X5R1C105K; GRM188R61C105K	VENKEL LTD./TAIYO YUDEN/TDK/MURATA	1UF	CAPACITOR; SMT; 0603; CERAMIC; 1uF; 16V; 10%; X5R; -55degC to + 85degC; 0 +/-15 NEW DESIGN
10	1	C55	C0603C105K4RAC; GRM188R71C105KA12; C1608X7R1C105K; EMK107B7105KA	KEMET/MURATA/TDK/TAIYO YUDEN	1UF	CAPACITOR; SMT (0603); CERAMIC CHIP; 1UF; 16V; TOL=10%; MODEL=; TG=-55 DEG
11	1	C57	TMK212BBJ106KG-T; CL21A106KAFN3N	TAIYO YUDEN	10UF	CAPACITOR; SMT (0805); CERAMIC CHIP; 10UF; 25V; TOL=10%; MODEL=; TG=-55 DEG
12	2	CB2, CB3	C0603C0G500-180JNE; C1608C0G1H180J; GRM1885C1H180J	VENKEL LTD./TDK/MURATA	18PF	CAPACITOR; SMT (0603); CERAMIC CHIP; 18PF; 50V; TOL=5%; MODEL=; TG=-55 DEG
13	1	D1	MBR0520L	FAIRCHILD SEMICONDUCTOR	MBR0520L	DIODE, SCHOTTKY, SOD-123, PIV=20V, Vf=0.385V@If=0.5A, If(ave)=0.5A
14	2	DGND, GNDS	5011	KEYSTONE	N/A	TEST POINT; PIN DIA=0.125IN; TOTAL LENGTH=0.445IN; BOARD HOLE=0.063IN; BLACK PLATE FINISH; RECOMMENDED FOR BOARD THICKNESS=0.062IN; NOT FOR COLD TEST
15	1	DGND2	5011	?	5011	TEST POINT; PIN DIA=0.125IN; TOTAL LENGTH=0.445IN; BOARD HOLE=0.063IN; BLACK PLATE FINISH; RECOMMENDED FOR BOARD THICKNESS=0.062IN
16	1	DSB1	LG L29K-G2J1-24	OSRAM	LG L29K-G2J1-24	DIODE; LED; SMT (0603); Vf=1.7V; If(test)=0.002A; -40 DEGC TO +100 DEGC
17	3	OP2+, IN_U12, EXT_REF	5010	KEYSTONE	N/A	TESTPOINT WITH 1.80MM HOLE DIA, RED, MULTIPURPOSE; NOT FOR COLD TEST
18	1	J1	10118192-0001LF	FCI CONNECT	10118192-0001LF	CONNECTOR; FEMALE; SMT; MICRO USB B TYPE RECEPTACLE; RIGHT ANGLE; 5PINS
19	5	J2, J3, J12-J14	PEC02SAAN	SULLINS	PEC02SA	CONNECTOR; MALE; THROUGH HOLE; BREAKAWAY; STRAIGHT; 2PINS
20	8	J4-J11	PEC03SAAN	SULLINS	PEC03SA	CONNECTOR; MALE; THROUGH HOLE; BREAKAWAY; STRAIGHT; 3PINS

21	1	L3	MPZ1608S601 A	TDK	600	INDUCTOR; SMT (0603); FERRITE-BEAD; 600; TOL=+/-25%; 1A; -55 DEGC TO +125 DEGC
22	5	OP+, OP-, VDD, REFF, REFS	5010 ?		5010	TESTPOINT WITH 1.80MM HOLE DIA, RED, MULTIPURPOSE
23	6	R1, R2, RB7, RB9, RB14, RB16	ERJ- 3EKF28R0V	PANASONIC	28	RESISTOR; 0603; 28 OHM; 1%; 100PPM; 0.10W; THICK FILM
24	2	R4, R9	RC1608J000CS ; CR0603-J/- 000ELF;RC060 3JR-070RL	SAMSUNG ELECTRONICS/BOU RNS/YAGEO PH	0	RESISTOR; 0603; 0 OHM; 5%; JUMPER; 0.10W; THICK FILM
25	1	R7	CRCW060310 K0JN; ERJ- 3GEYJ103V	VISHAY DALE; PANASONIC	10K	RESISTOR; 0603; 10K OHM; 5%; 200PPM; 0.10W; THICK FILM
26	1	RB3	CRCW060312 K0FK	VISHAY DALE	12K	RESISTOR, 0603, 12K OHM, 1%, 100PPM, 0.10W, THICK FILM
27	1	RB4	CRCW060315 K0FK	VISHAY DALE	15K	RESISTOR, 0603, 15K OHM,1%, 100PPM, 0.10W, THICK FILM
28	7	RB5, RB6, RB8, RB11, RB13, RB15, RB24	CRCW060310 K0FK; 9C06031A100 2FK; ERJ- 3EKF1002	VISHAY DALE/YAGEO PHICOMP/PANASO NIC	10K	RESISTOR; 0603; 10K; 1%; 100PPM; 0.10W; THICK FILM
29	1	RB10	CRCW06032K 20FK	VISHAY DALE	2.2K	RESISTOR, 0603, 2.2K OHM, 1%, 100PPM, 0.10W, THICK FILM
30	1	RB17	CRCW06034K 70FK	VISHAY DALE	4.7K	RESISTOR; 0603; 4.7K; 1%; 100PPM; 0.10W; THICK FILM
31	1	U1	MAX5719	MAXIM	MAX5719	EVKIT PART - IC; MAX5719; NSOIC14 150MIL; PKG. DWG. NO.: 21-0041
32	2	U4, U13	MAX9632ASA +	MAXIM	MAX9632 ASA+	IC; OPAMP; PRECISION, LOW-NOISE, WIDE-BAND AMPLIFIER; NSOIC8 150MIL; -40 DEGC
33	2	U6, U8	MAX1840EUB	MAXIM	MAX1840 EUB	IC; TRANS; LOW-VOLTAGE SIM/SMART CARD LEVEL TRANSLATOR; UMAX10
34	1	U12	MAX6126AAS A41+	MAXIM	MAX6126 AASA41	IC; VREF; ULTRA-HIGH PRECISION; ULTRA-LOW NOISE; SERIES VOLTAGE REFERENCE; -40 DEGC
35	1	U14	MAX15006AA TT+	MAXIM	MAX1500 6AATT+	IC; VREG; ULTRA-LOW QUIESCENT-CURRENT LINEAR REGULATOR; TDFN6-EP 3X3
36	1	UB1	93LC66BT- I/OT	MICROCHIP	93LC66BT- I/OT	IC; EPROM; 4K MICROWIRE SERIAL EEPROM; SOT23-6
37	1	UB2	FT2232HL	FUTURE TECHNOLOGY DEVICES INTL LTD.	FT2232HL	IC; MMRY; DUAL HIGH SPEED USB TO MULTIPURPOSE UART/FIFO; LQFP64
38	13	XJU1-XJU13	STC02SYAN	SULLINS ELECTRONICS CORP.	STC02SYA N	TEST POINT; JUMPER; STR; TOTAL LENGTH=0.256IN; BLACK; INSULATION=PBT CONTACT PLATED TIN OVERALL

39	1	YB1	ABM7-12.000MHZ-D2Y-T	ABRACON	12MHZ	CRYSTAL; SMT ; 18PF; 12MHZ; +/-20PPM; +/-30PPM
40	1		MAX	MAXIM	PCB	PCB: MAX
TOTAL	117					

DO NOT PURCHASE(DNP)

ITEM	QTY	REF DES	MFG PART #	MANUFACTURER	VALUE	DESCRIPTION
1	3	C14-C16	N/A	N/A	OPEN	PACKAGE OUTLINE 0603 NON-POLAR CAPACITOR - EVKIT
2	2	R3, R5	N/A	N/A	OPEN	PACKAGE OUTLINE 0603 RESISTOR - EVKIT
3	1	R6	N/A	N/A	SHORT	PACKAGE OUTLINE 0805 RESISTOR - EVKIT
TOTAL	6					

PACKOUT (These are purchased parts but not assembled on PCB and will be shipped with PCB)

ITEM	QTY	REF DES	MFG PART #	MANUFACTURER	VALUE	DESCRIPTION
1	1	PACKOUT	88-00711-SML	N/A	?	BOX;SMALL BROWN 9 3/16X7X1 1/4 - PACKOUT
2	1	PACKOUT	87-02162-00	N/A	?	ESD BAG;BAG;STATIC SHIELD ZIP 4inX6in;W/ESD LOGO - PACKOUT
3	1	PACKOUT	85-MAXKIT-PNK	N/A	?	PINK FOAM;FOAM;ANTI-STATIC PE 12inX12inX5MM - PACKOUT
4	1	PACKOUT	EVINSERT	N/A	?	WEB INSTRUCTIONS FOR MAXIM DATA SHEET
5	1	PACKOUT	85-84003-006	N/A	?	LABEL(EV KIT BOX) - PACKOUT
6	1	X1	AK67421-1-R	ASSMANN	OR; MALE; USB; USB2.0 MICRO CONNECT ION CABLE; USB B MICRO MALE TO USB A	

TOTAL 6

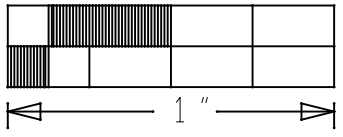
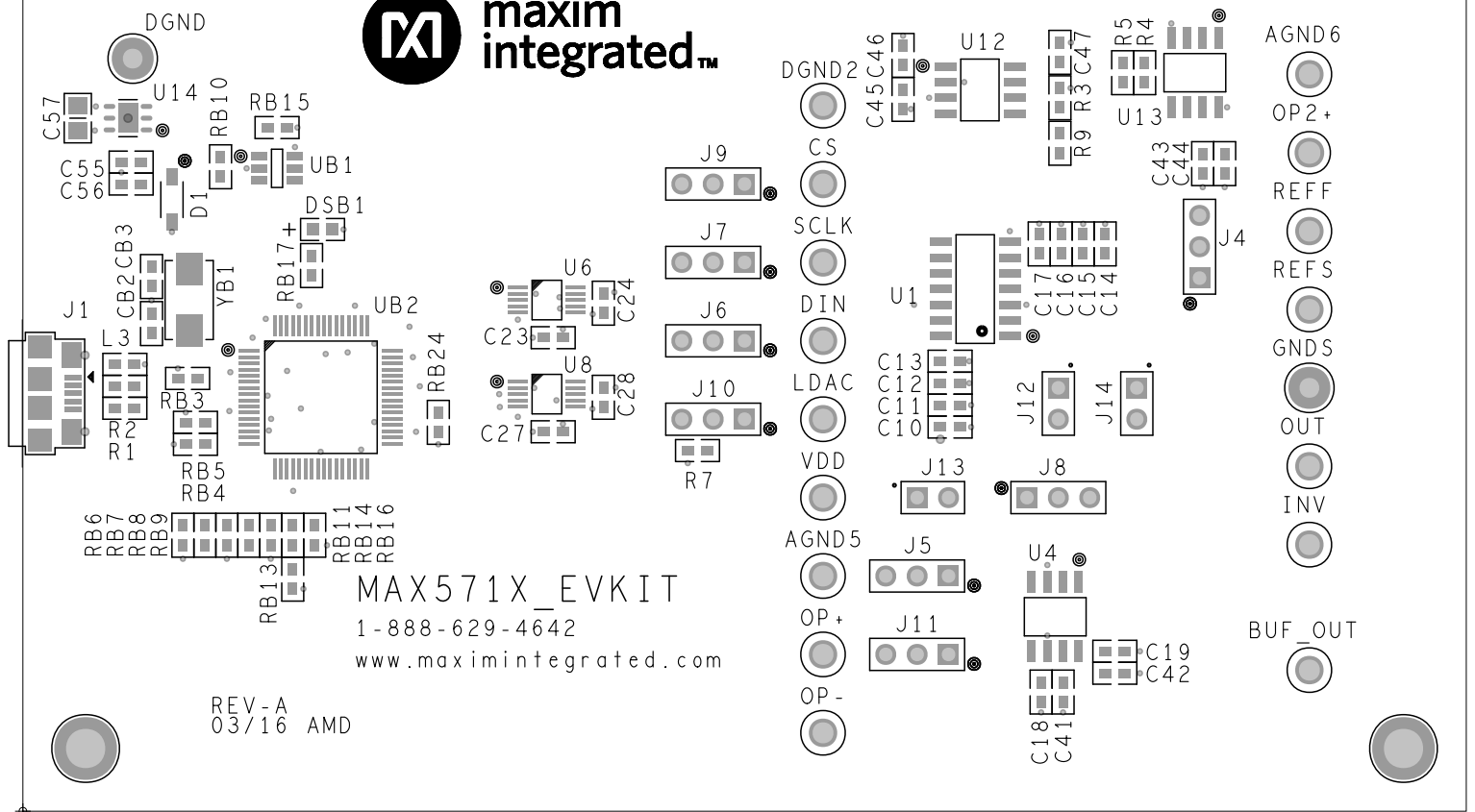

TOP SILKSCREEN

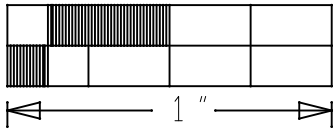
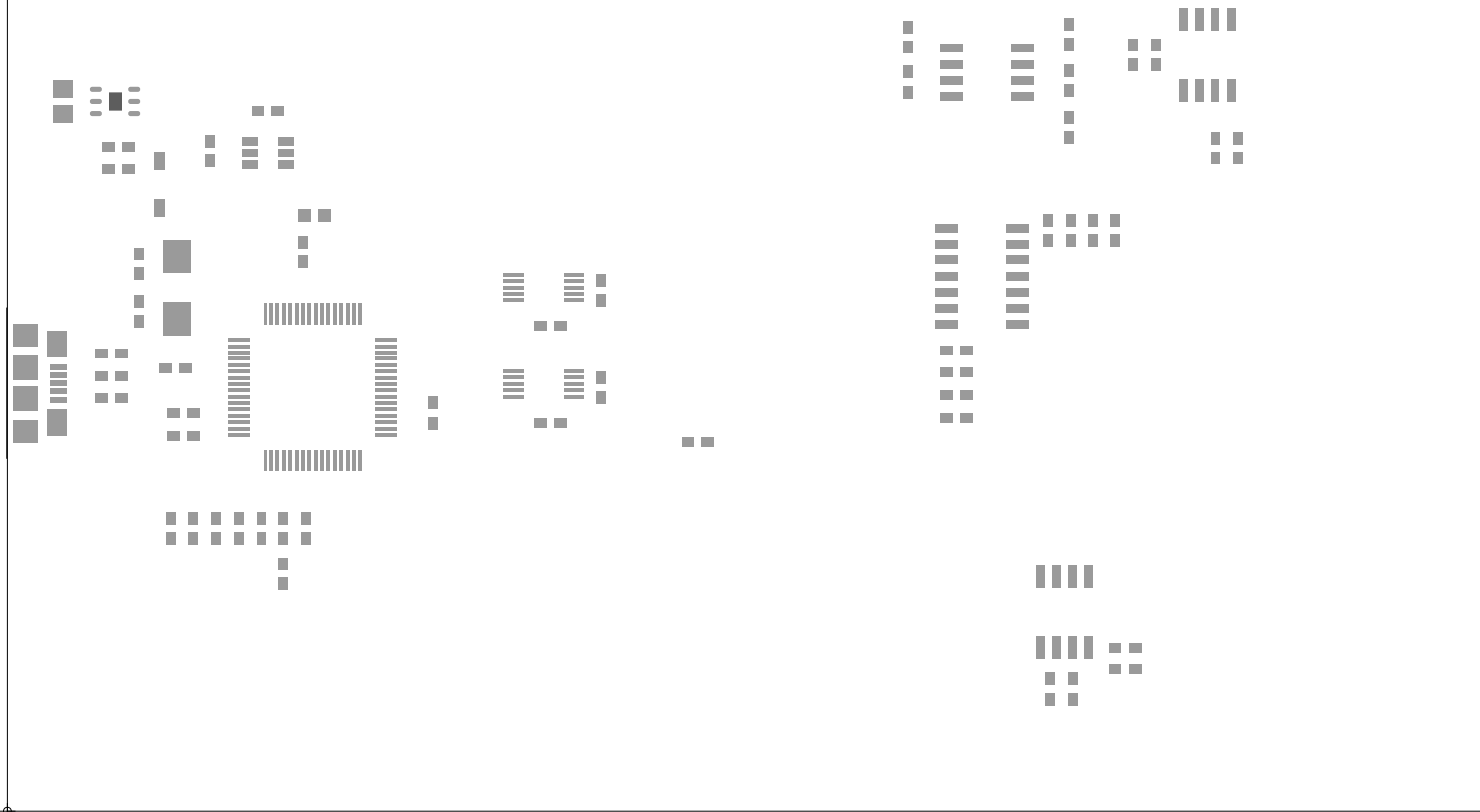

TOP PASTE

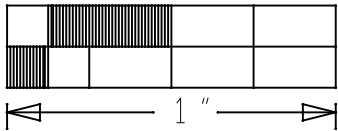
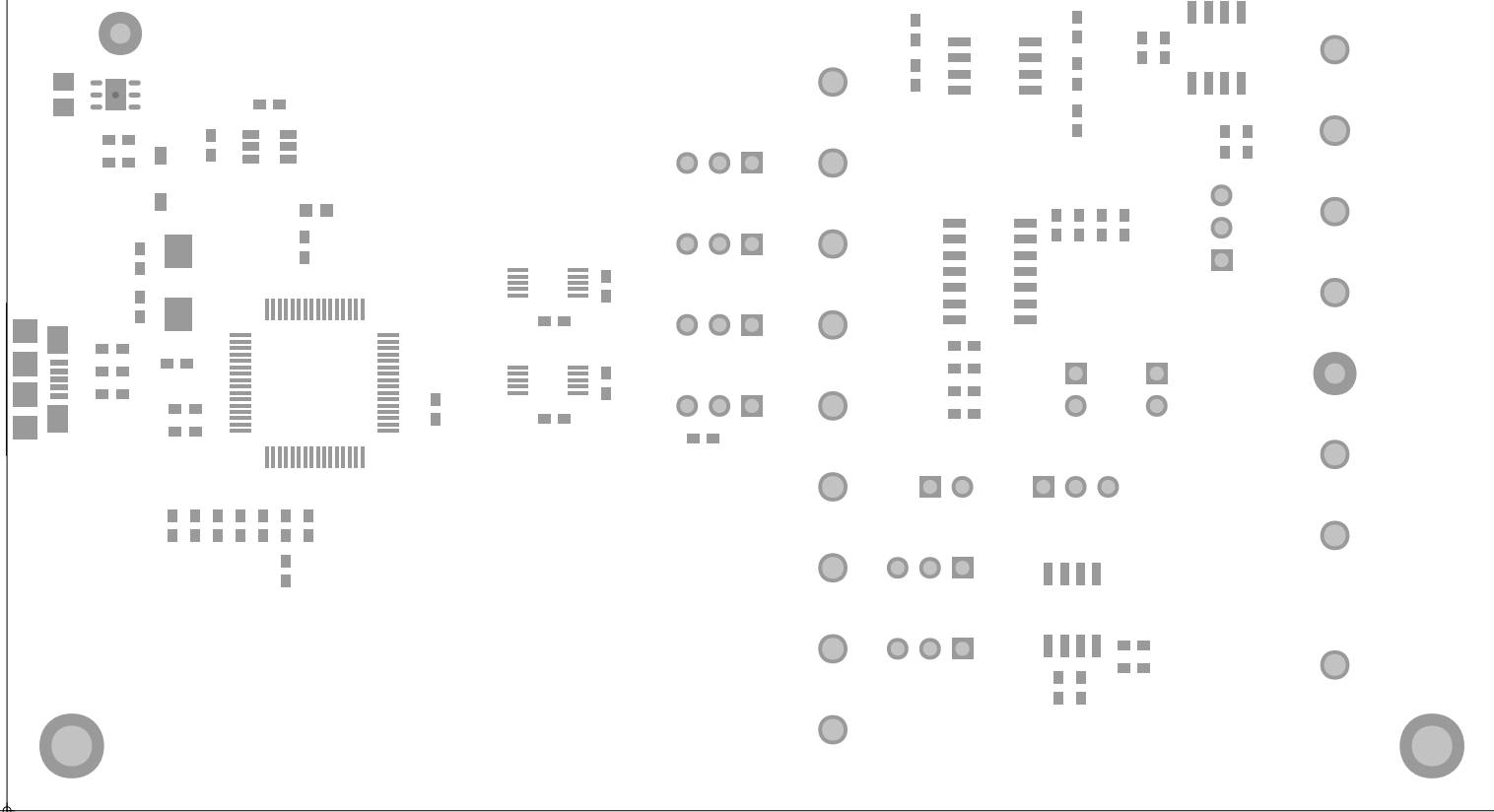

TOP MASK

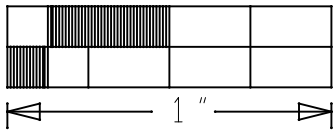
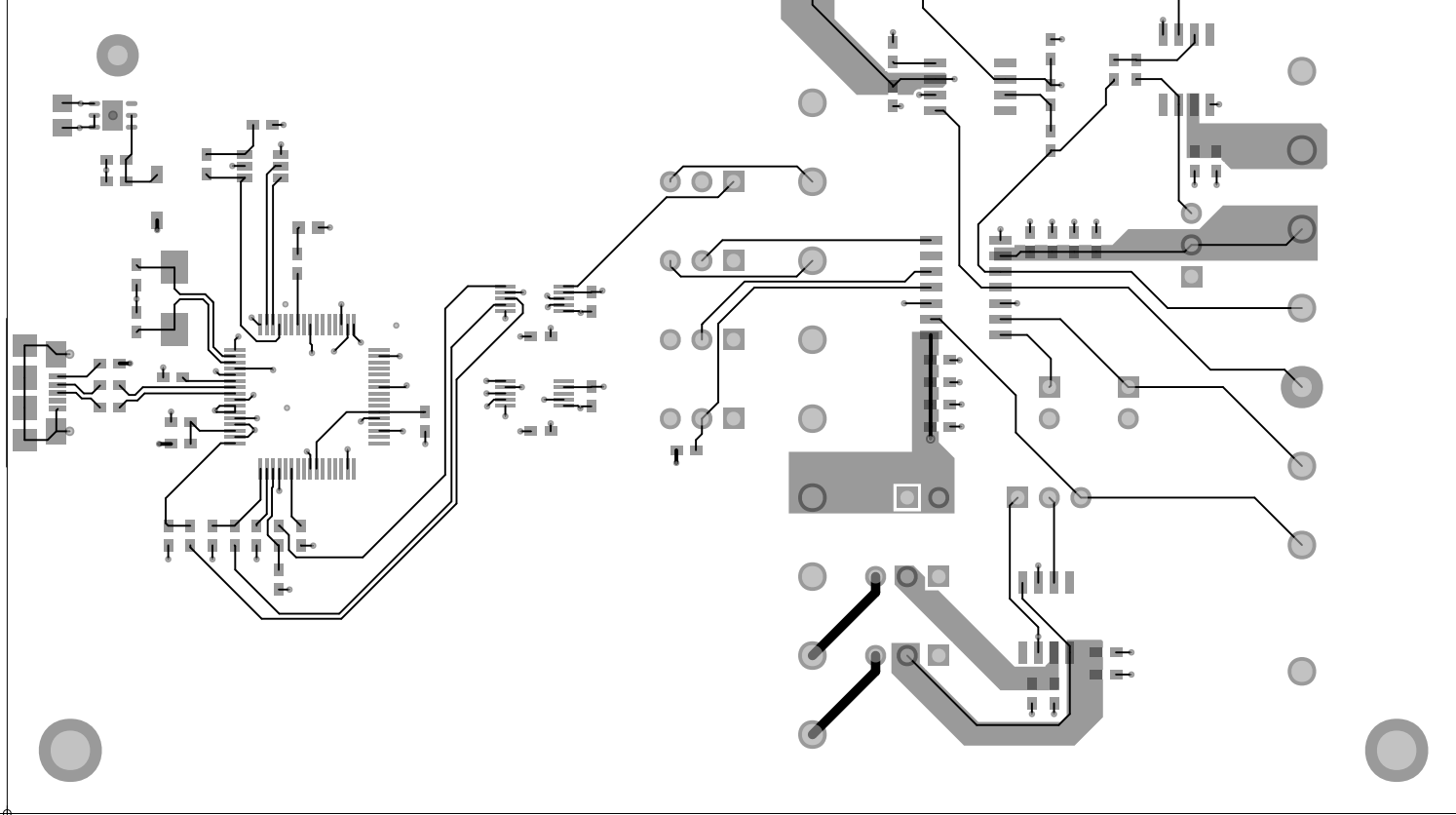

TOP

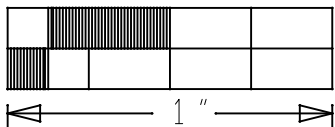
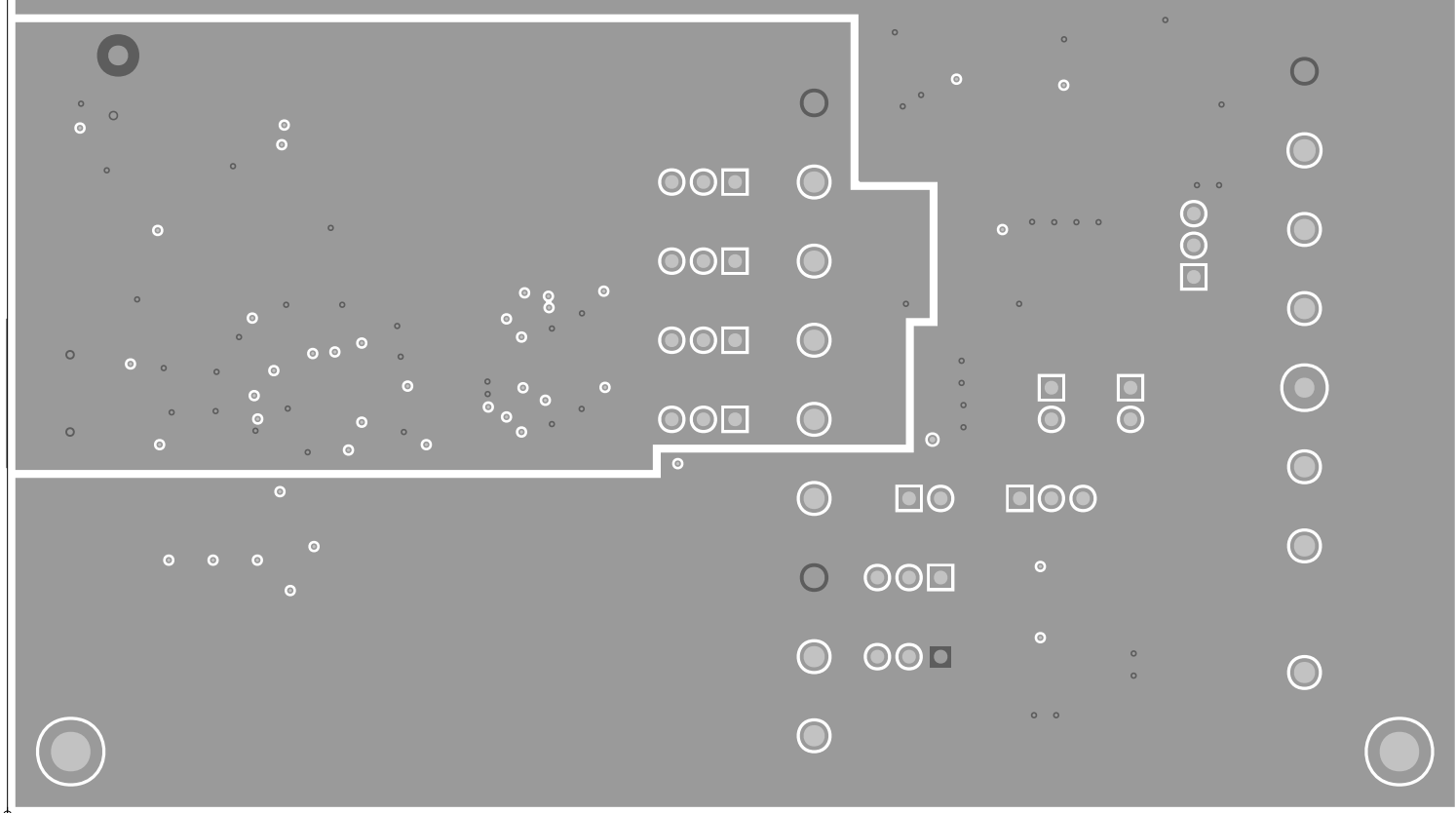

LAYER 2

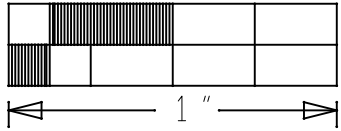
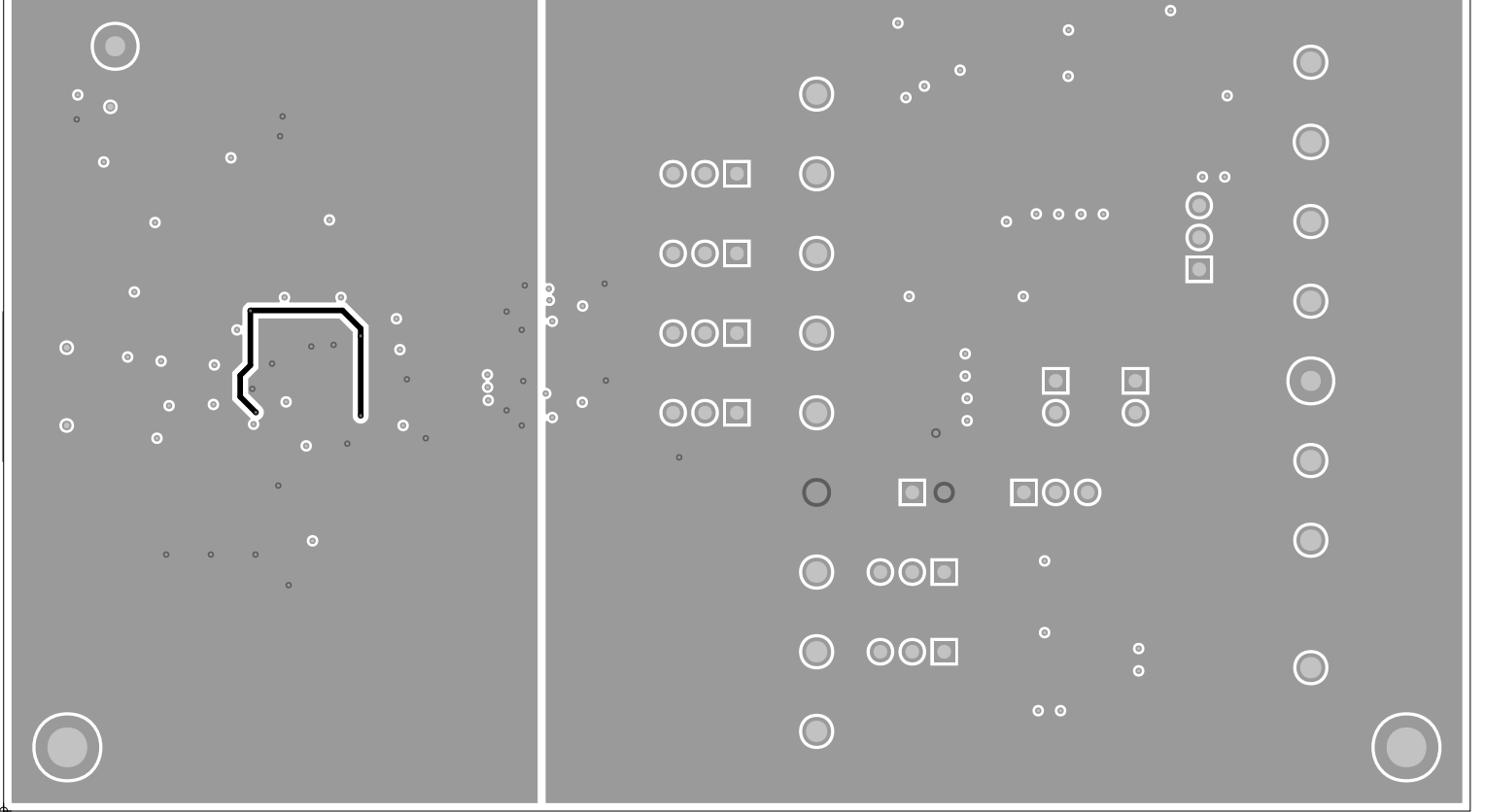

LAYER 3

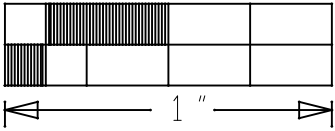
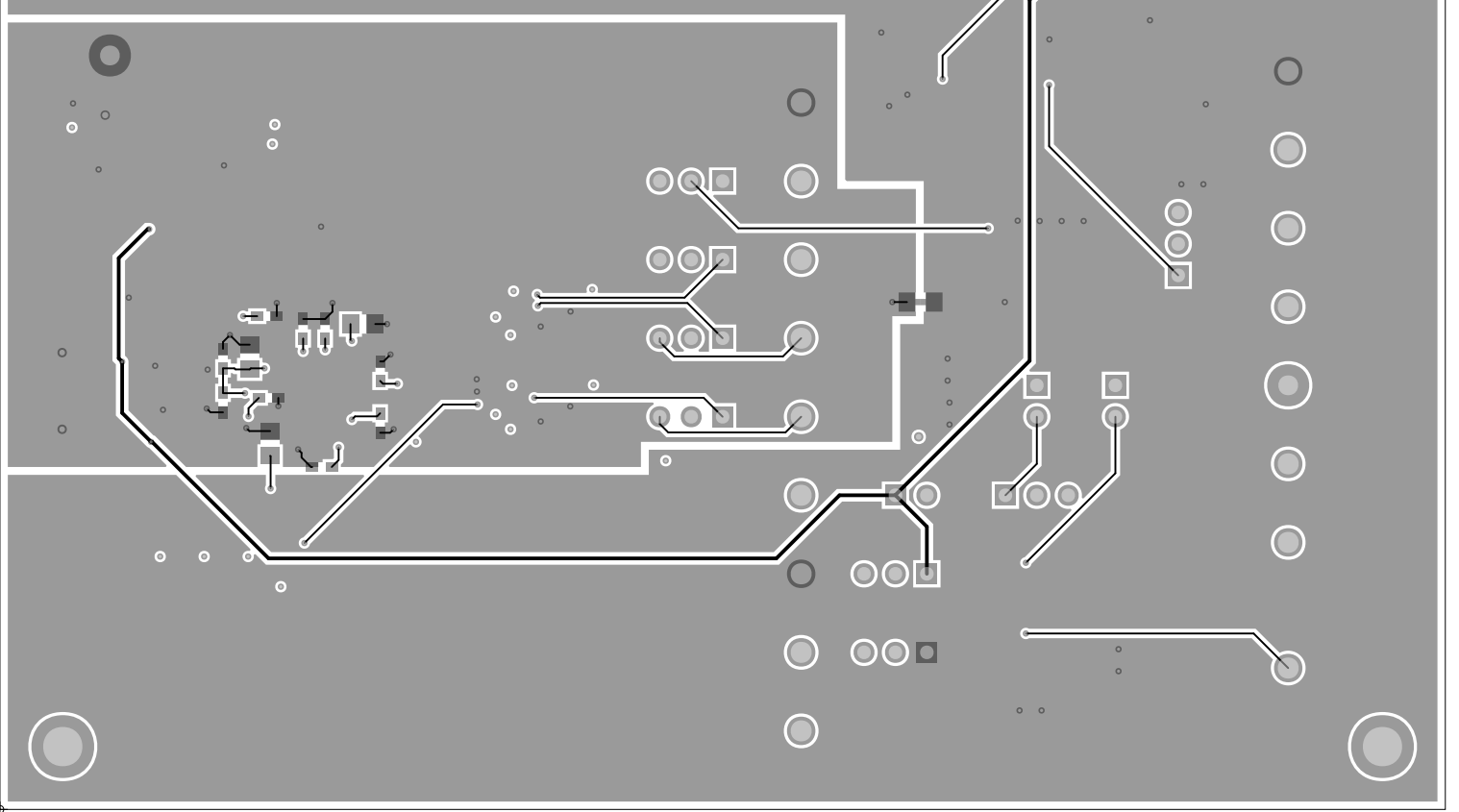

BOTTOM

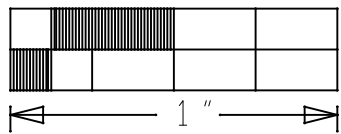
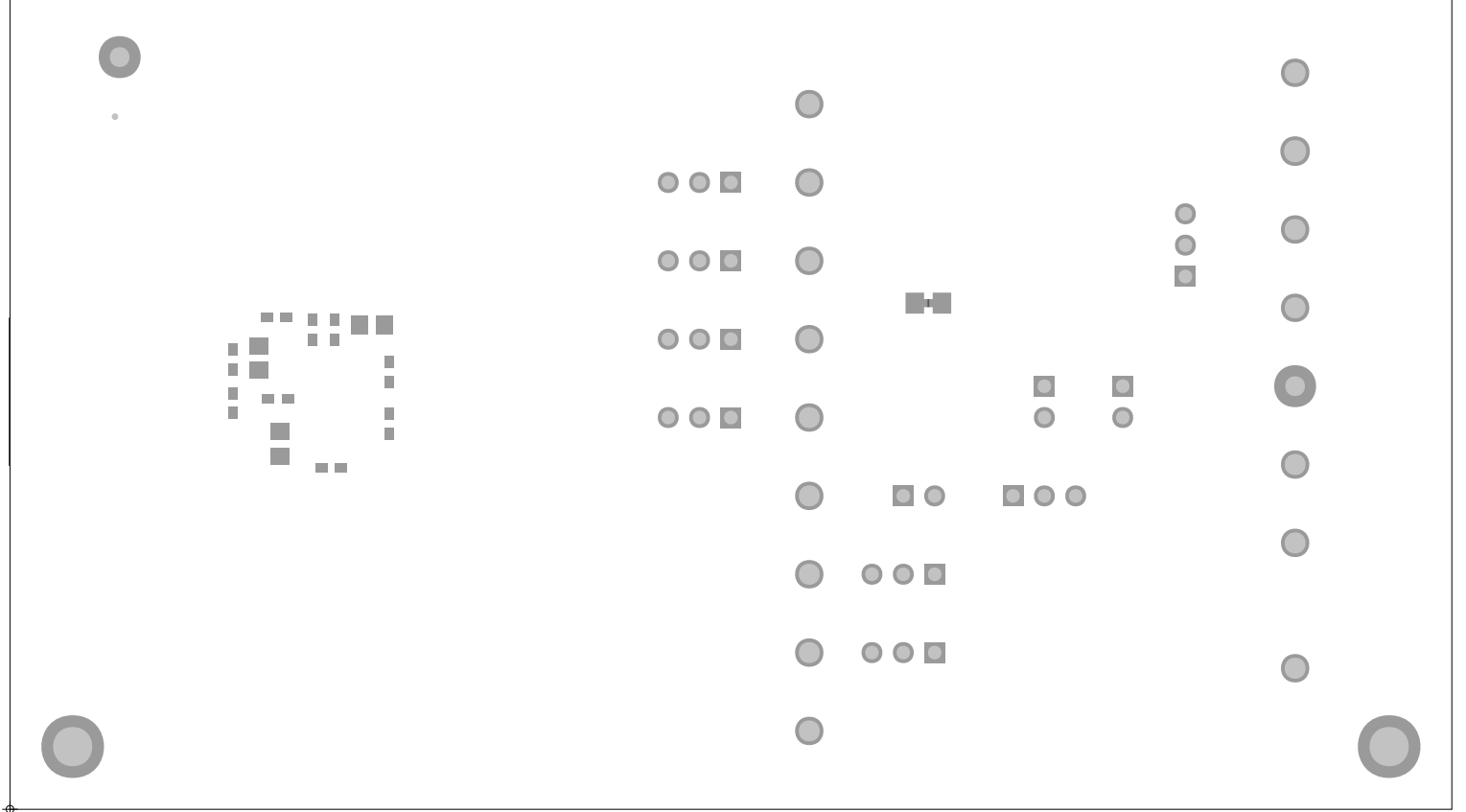

BOTTOM MASK

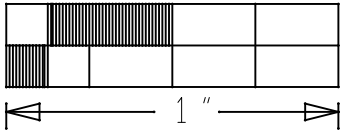
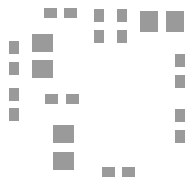

BOTTOM PASTE

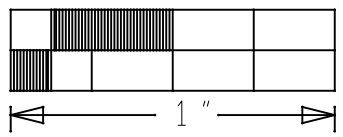
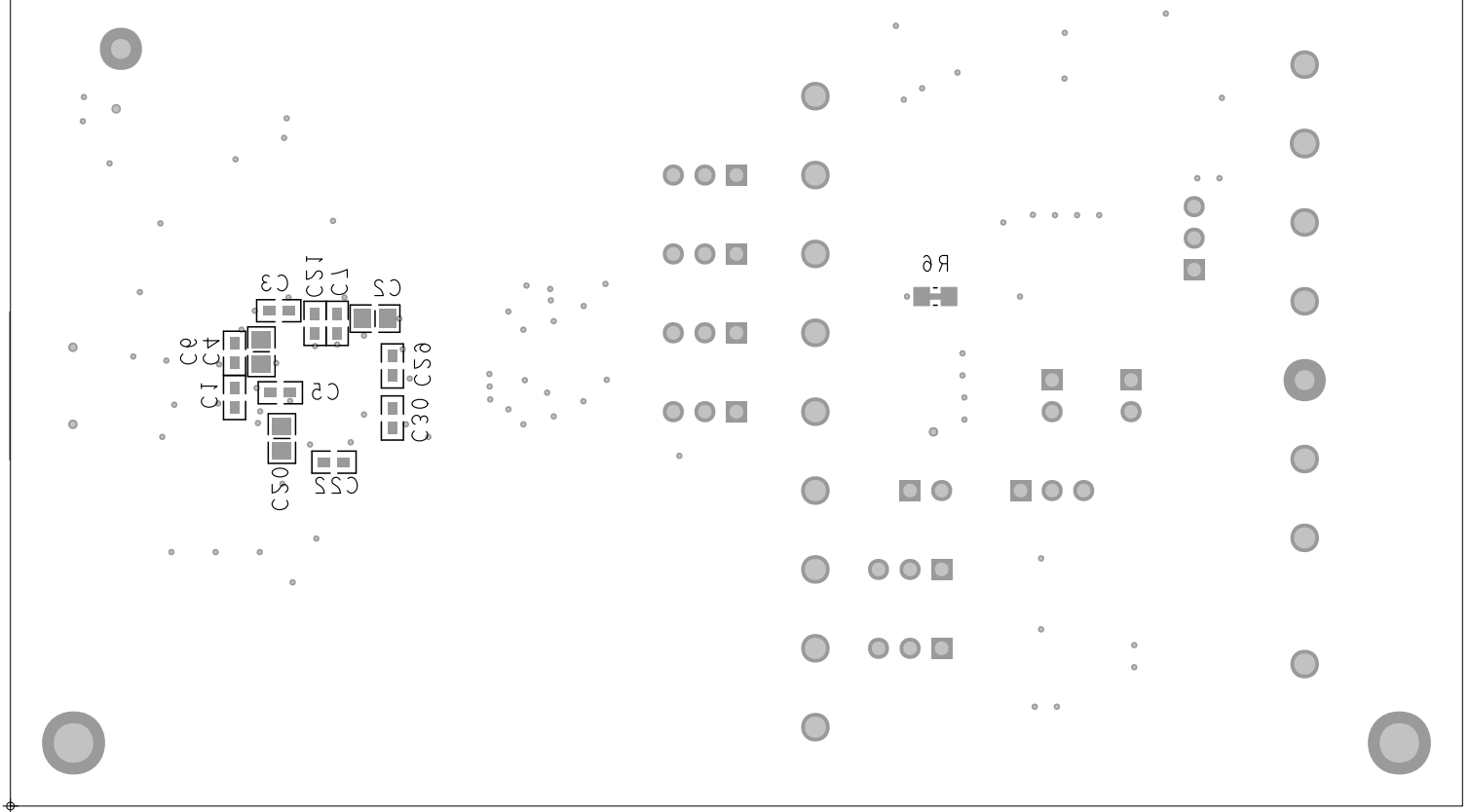

BOTTOM SILKSCREEN

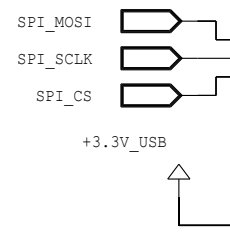
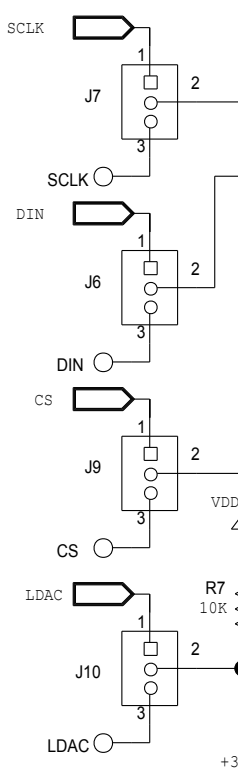
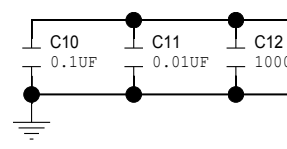
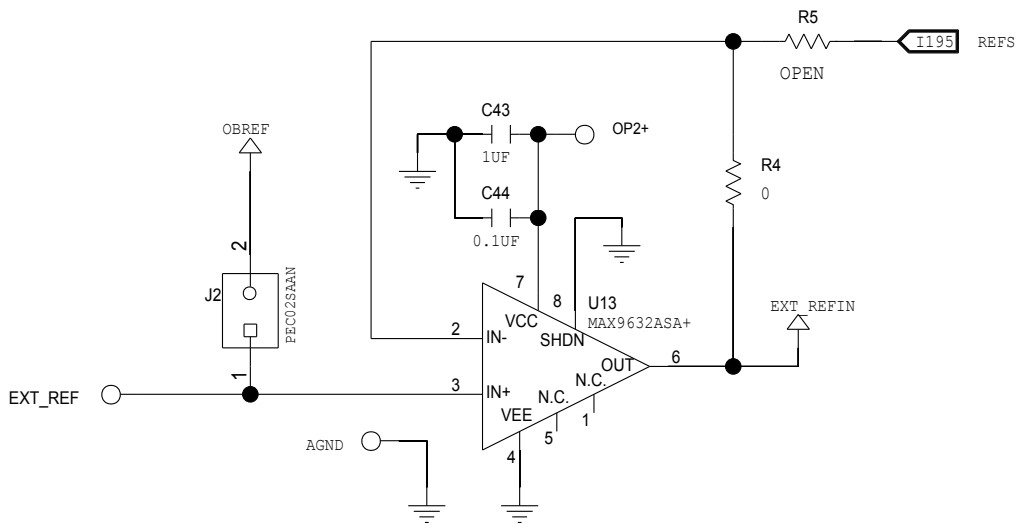
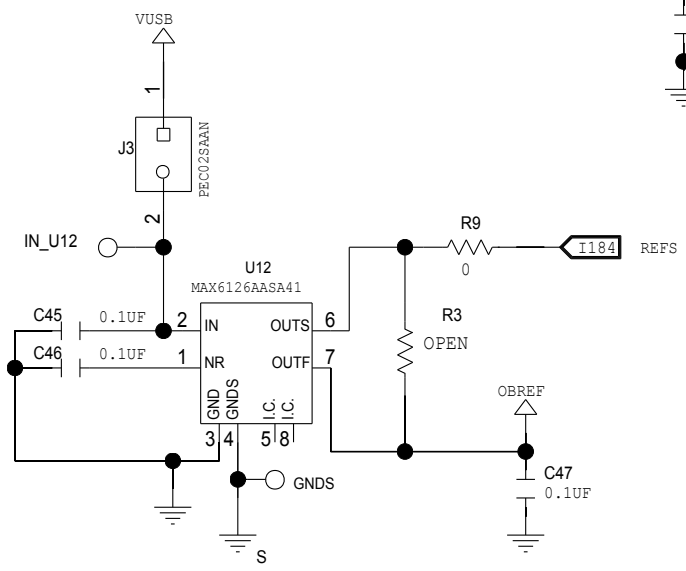

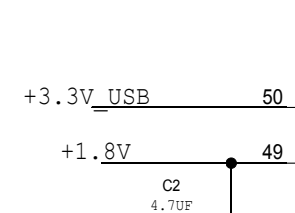
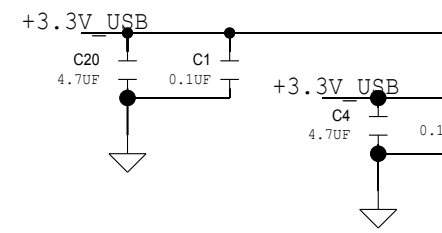
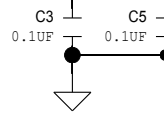

U3
CONFIG

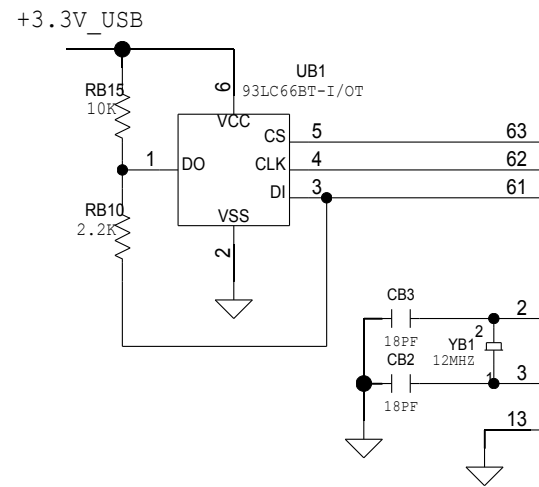
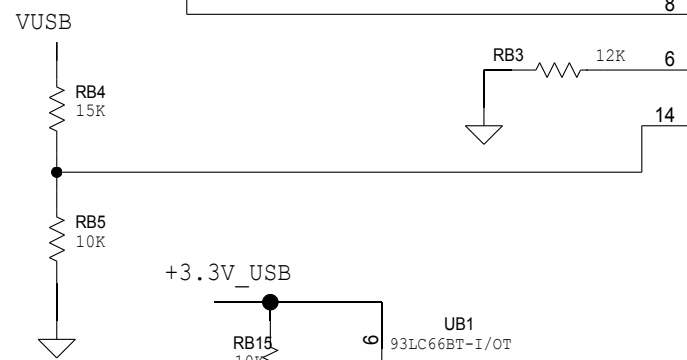
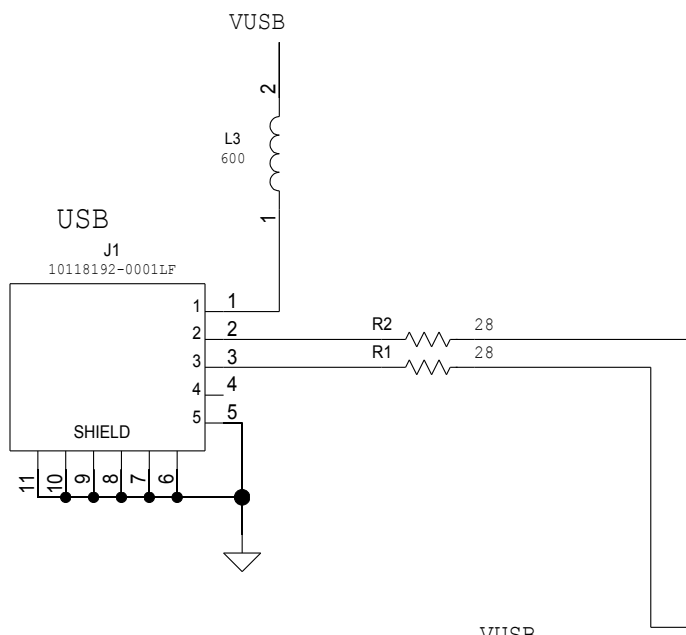

USB POWER

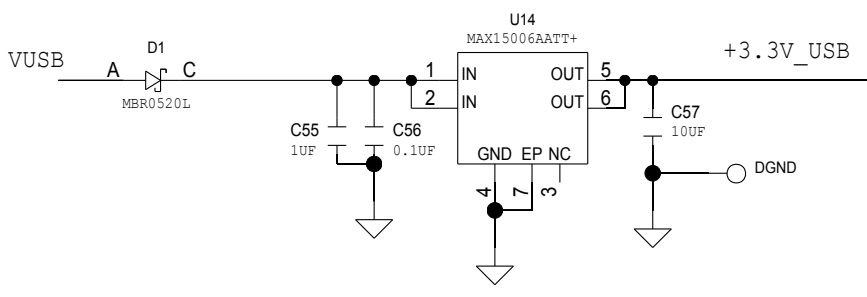

X-ON Electronics

Largest Supplier of Electrical and Electronic Components

Click to view similar products for [Data Conversion IC Development Tools](#) category:

Click to view products by [Maxim](#) manufacturer:

Other Similar products are found below :

[EVAL-AD5063EBZ](#) [EVAL-AD5422LFEBZ](#) [EVAL-AD7265EDZ](#) [EVAL-AD7641EDZ](#) [EVAL-AD7674EDZ](#) [EVAL-AD7719EBZ](#) [EVAL-AD7767-1EDZ](#) [EVAL-AD7995EBZ](#) [AD9114-DPG2-EBZ](#) [AD9211-200EBZ](#) [AD9230-170EBZ](#) [AD9251-20EBZ](#) [AD9251-65EBZ](#) [AD9255-125EBZ](#) [AD9284-250EBZ](#) [AD9613-170EBZ](#) [AD9627-125EBZ](#) [AD9629-20EBZ](#) [AD9709-EBZ](#) [AD9716-DPG2-EBZ](#) [AD9737A-EBZ](#) [AD9787-DPG2-EBZ](#) [AD9993-EBZ](#) [DAC8555EVM](#) [ADS5482EVM](#) [ADS8372EVM](#) [EVAL-AD5061EBZ](#) [EVAL-AD5062EBZ](#) [EVAL-AD5443-DBRDZ](#) [EVAL-AD5570SDZ](#) [EVAL-AD7450ASDZ](#) [EVAL-AD7677EDZ](#) [EVAL-AD7992EBZ](#) [EVAL-AD7994EBZ](#) [AD9119-MIX-EBZ](#) [AD9148-M5375-EBZ](#) [AD9204-80EBZ](#) [AD9233-125EBZ](#) [AD9265-105EBZ](#) [AD9265-80EBZ](#) [AD9608-125EBZ](#) [AD9629-80EBZ](#) [AD9648-125EBZ](#) [AD9649-20EBZ](#) [AD9650-80EBZ](#) [AD9736-DPG2-EBZ](#) [AD9765-EBZ](#) [AD9767-EBZ](#) [AD9778A-DPG2-EBZ](#) [ADS8322EVM](#)