



**MAX5969D**

# IEEE 802.3af/at-Compliant, Powered Device Interface Controller with Integrated Power MOSFET

## General Description

The MAX5969D provides a complete interface for a powered device (PD) to comply with the IEEE® 802.3af/at standard in a power-over-Ethernet (PoE) system. The MAX5969D provides the PD with a detection signature, classification signature, and an integrated isolation power switch with inrush current control. During the inrush period, the MAX5969D limits the current to less than 180mA before switching to the higher current limit (720mA to 880mA) when the isolation power MOSFET is fully enhanced. The device features an input UVLO with wide hysteresis and long deglitch time to compensate for twisted-pair cable resistive drop and to assure glitch-free transition during power-on/-off conditions. The MAX5969D can withstand up to 100V at the input.

The MAX5969D supports a 2-event classification method as specified in the IEEE 802.3at standard and provide a signal to indicate when probed by a Type 2 power sourcing equipment (PSE). The device detects the presence of a wall adapter power source connection and allow a smooth switch over from the PoE power source to the wall power adaptor.

The MAX5969D also provides a power-good (PG) signal, two-step current limit and foldback, overtemperature protection, and di/dt limit. The MAX5969D is available in a 16-pin, 5mm x 5mm TQFN power package. This device is rated over the -40°C to +85°C extended temperature range.

## Features

- ◆ IEEE 802.3af/at Compliant
- ◆ 2-Event Classification or an External Wall Adapter Indicator Output
- ◆ Simplified Wall Adapter Interface
- ◆ PoE Classification 0–5
- ◆ 100V Input Absolute Maximum Rating
- ◆ Inrush Current Limit of 180mA Maximum
- ◆ Current Limit During Normal Operation Between 720mA and 880mA
- ◆ Current Limit and Foldback
- ◆ Legacy UVLO at 36V
- ◆ Overtemperature Protection
- ◆ Thermally Enhanced, 5mm x 5mm, 16-Pin TQFN

## Applications

IEEE 802.3af/at Powered Devices  
 IP Phones, Wireless Access Nodes, IP Security Cameras  
 WiMAX™ Base Stations

## Ordering Information

PART	TEMP RANGE	PIN-PACKAGE
MAX5969DETE+	-40°C to +85°C	16 TQFN-EP*

+Denotes a lead(Pb)-free/RoHS-compliant package.  
 \*EP = Exposed pad.

WiMAX is a trademark of WiMAX Forum.

IEEE is a registered service mark of the Institute of Electrical and Electronics Engineers, Inc.



# IEEE 802.3af/at-Compliant, Powered Device Interface Controller with Integrated Power MOSFET

## ABSOLUTE MAXIMUM RATINGS

VDD to VSS .....	-0.3V to +100V	Operating Temperature Range .....	-40°C to +85°C
DET, RTN, WAD, PG, $\overline{2EC}$ to VSS .....	-0.3V to +100V	Maximum Junction Temperature .....	+150°C
CLS to VSS .....	-0.3V to +6V	Storage Temperature Range .....	-65°C to +150°C
Maximum Current on CLS (100ms maximum) .....	100mA	Lead Temperature (soldering, 10s) .....	+300°C
Continuous Power Dissipation (TA = +70°C) (Note 1)		Soldering Temperature .....	+260°C
TQFN (derate 28.6mW/°C above +70°C)			
Multilayer Board .....	2285.7mW		

**Note 1:** Maximum power dissipation is obtained using JEDEC JESD51-5 and JESD51-7 specifications.

Stresses beyond those listed under "Absolute Maximum Ratings" may cause permanent damage to the device. These are stress ratings only, and functional operation of the device at these or any other conditions beyond those indicated in the operational sections of the specifications is not implied. Exposure to absolute maximum rating conditions for extended periods may affect device reliability.

## PACKAGE THERMAL CHARACTERISTICS (Note 2)

TQFN

Junction-to-Ambient Thermal Resistance ( $\theta_{JA}$ ).....35°C/W

Junction-to-Case Thermal Resistance ( $\theta_{JC}$ ) .....2.7°C/W

**Note 2:** Package thermal resistances were obtained using the method described in JEDEC specification JESD51-7, using a four-layer board. For detailed information on package thermal considerations, refer to <http://www.maxim-ic.com/thermal-tutorial>.

## ELECTRICAL CHARACTERISTICS

(VIN = (VDD - VSS) = 48V, RDET = 24.9k $\Omega$ , RCLS = 615 $\Omega$ , and R $\overline{S}$  = 60.4k $\Omega$ . RTN, WAD, PG, and  $\overline{2EC}$  unconnected, all voltages are referenced to VSS, unless otherwise noted. TA = TJ = -40°C to +85°C, unless otherwise noted. Typical values are at TA = +25°C.) (Note 3)

PARAMETER	SYMBOL	CONDITIONS	MIN	TYP	MAX	UNITS
<b>DETECTION MODE</b>						
Input Offset Current	I <sub>OFFSET</sub>	V <sub>IN</sub> = 1.4V to 10.1V (Note 4)			10	$\mu$ A
Effective Differential Input Resistance	dR	V <sub>IN</sub> = 1.4V up to 10.1V with 1V step, V <sub>DD</sub> = RTN = WAD = PG = $\overline{2EC}$ (Note 5)	23.95	25.00	25.50	k $\Omega$
<b>CLASSIFICATION MODE</b>						
Classification Disable Threshold	V <sub>TH,CLS</sub>	V <sub>IN</sub> rising (Note 6)	22.0	22.8	23.6	V
Classification Stability Time				0.2		ms
Classification Current	I <sub>CLASS</sub>	V <sub>IN</sub> = 12.5V to 20.5V, V <sub>DD</sub> = RTN = WAD = PG = $\overline{2EC}$	Class 0, R <sub>CLS</sub> = 619 $\Omega$	0	3.96	mA
			Class 1, R <sub>CLS</sub> = 117 $\Omega$	9.12	11.88	
			Class 2, R <sub>CLS</sub> = 66.5 $\Omega$	17.2	19.8	
			Class 3, R <sub>CLS</sub> = 43.7 $\Omega$	26.3	29.7	
			Class 4, R <sub>CLS</sub> = 30.9 $\Omega$	36.4	43.6	
		Class 5, R <sub>CLS</sub> = 21.3 $\Omega$	52.7	63.3		
<b>TYPE 2 (802.3at) CLASSIFICATION MODE</b>						
Mark Event Threshold	V <sub>THM</sub>	V <sub>IN</sub> falling	10.1	10.7	11.6	V
Hysteresis on Mark Event Threshold				0.84		V

# IEEE 802.3af/at-Compliant, Powered Device Interface Controller with Integrated Power MOSFET

## ELECTRICAL CHARACTERISTICS (continued)

( $V_{IN} = (V_{DD} - V_{SS}) = 48V$ ,  $R_{DET} = 24.9k\Omega$ ,  $R_{CLS} = 615\Omega$ , and  $R_{SL} = 60.4k\Omega$ . RTN, WAD, PG, and  $\overline{2EC}$  unconnected, all voltages are referenced to  $V_{SS}$ , unless otherwise noted.  $T_A = T_J = -40^\circ C$  to  $+85^\circ C$ , unless otherwise noted. Typical values are at  $T_A = +25^\circ C$ .) (Note 3)

PARAMETER	SYMBOL	CONDITIONS	MIN	TYP	MAX	UNITS
Mark Event Current	$I_{MARK}$	$V_{IN}$ falling to enter mark event, $5.2V \leq V_{IN} \leq 10.1V$	0.25		0.85	mA
Reset Event Threshold	$V_{THR}$	$V_{IN}$ falling	2.8	4	5.2	V
<b>POWER MODE</b>						
$V_{IN}$ Supply Voltage Range					60	V
$V_{IN}$ Supply Current	$I_Q$			0.27	0.55	mA
$V_{IN}$ Turn-On Voltage	$V_{ON}$	$V_{IN}$ rising	34.3	35.4	36.6	V
$V_{IN}$ Turn-Off Voltage	$V_{OFF}$	$V_{IN}$ falling	30			V
$V_{IN}$ Turn-On/-Off Hysteresis	$V_{HYST\_UVLO}$	(Note 7)	4.2			V
$V_{IN}$ Deglitch Time	$t_{OFF\_DLY}$	$V_{IN}$ falling from 40V to 20V (Note 8)	30	120		$\mu s$
Inrush to Operating Mode Delay	$t_{DELAY}$	$t_{DELAY}$ = minimum PG current pulse width after entering into power mode	87	96	105	ms
Isolation Power MOSFET On-Resistance	$R_{ON\_ISO}$	$I_{RTN} = 600mA$				$\Omega$
		$T_J = +25^\circ C$		0.5	0.7	
		$T_J = +85^\circ C$		0.65	1	
		$T_J = +125^\circ C$		0.8		
RTN Leakage Current	$I_{RTN\_LKG}$	$V_{RTN} = 12.5V$ to 30V			10	$\mu A$
<b>CURRENT LIMIT</b>						
Inrush Current Limit	$I_{INRUSH}$	During initial turn-on period, $V_{RTN} = 1.5V$	90	135	180	mA
Current Limit During Normal Operation	$I_{LIM}$	After inrush completed, $V_{RTN} = 1V$	720	800	880	mA
Foldback Threshold		$V_{RTN}$ (Note 9)	13		16.5	V
<b>LOGIC</b>						
WAD Detection Threshold	$V_{WAD\_REF}$	$V_{WAD}$ rising, $V_{IN} = 14V$ to 48V (referenced to RTN)	8	9	10	V
WAD Detection Threshold Hysteresis		$V_{WAD}$ falling, $V_{RTN} = 0V$ , $V_{SS}$ unconnected		0.725		V
WAD Input Current	$I_{WAD\_LKG}$	$V_{WAD} = 10V$ (referenced to RTN)			3.5	$\mu A$
$\overline{2EC}$ Sink Current		$V_{\overline{2EC}} = 3.5V$ (referenced to RTN), $V_{SS}$ unconnected	1	1.5	2.25	mA
$\overline{2EC}$ Off-Leakage Current		$V_{\overline{2EC}} = 48V$			1	$\mu A$

# IEEE 802.3af/at-Compliant, Powered Device Interface Controller with Integrated Power MOSFET

## ELECTRICAL CHARACTERISTICS (continued)

( $V_{IN} = (V_{DD} - V_{SS}) = 48V$ ,  $R_{DET} = 24.9k\Omega$ ,  $R_{CLS} = 615\Omega$ , and  $R_{S\bar{L}} = 60.4k\Omega$ .  $RTN$ ,  $WAD$ ,  $PG$ , and  $\overline{2EC}$  unconnected, all voltages are referenced to  $V_{SS}$ , unless otherwise noted.  $T_A = T_J = -40^\circ C$  to  $+85^\circ C$ , unless otherwise noted. Typical values are at  $T_A = +25^\circ C$ .) (Note 3)

PARAMETER	SYMBOL	CONDITIONS	MIN	TYP	MAX	UNITS
PG Sink Current		$V_{RTN} = 1.5V$ , $V_{PG} = 0.8V$ , during inrush period	125	230	375	$\mu A$
PG Off-Leakage Current		$V_{PG} = 60V$			1	$\mu A$
<b>THERMAL SHUTDOWN</b>						
Thermal-Shutdown Threshold	$T_{SD}$	$T_J$ rising		+140		$^\circ C$
Thermal-Shutdown Hysteresis		$T_J$ falling		28		$^\circ C$

**Note 3:** This device is 100% production tested at  $T_A = +25^\circ C$ . Limits over temperature are guaranteed by design.

**Note 4:** The input offset current is illustrated in Figure 1.

**Note 5:** Effective differential input resistance is defined as the differential resistance between  $V_{DD}$  and  $V_{SS}$ . See Figure 1.

**Note 6:** Classification current is turned off whenever the device is in power mode.

**Note 7:** UVLO hysteresis is guaranteed by design, not production tested.

**Note 8:** A 20V glitch on input voltage, which takes  $V_{DD}$  below  $V_{ON}$  shorter than or equal to  $t_{OFF\_DLY}$  does not cause the MAX5969D to exit power-on mode.

**Note 9:** In power mode, current-limit foldback is used to reduce the power dissipation in the isolation MOSFET during an overload condition across  $V_{DD}$  and  $RTN$ .

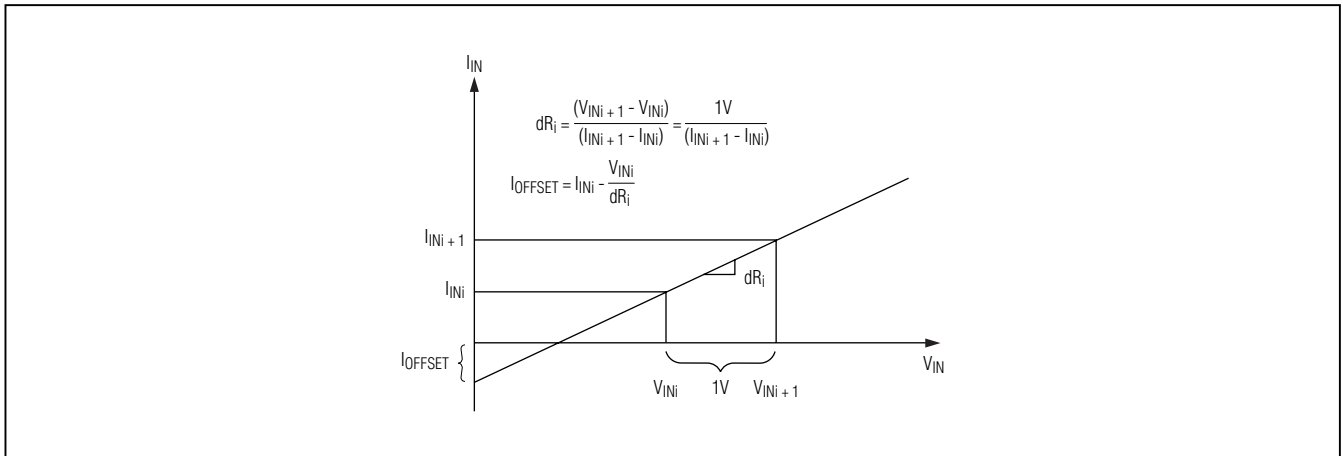
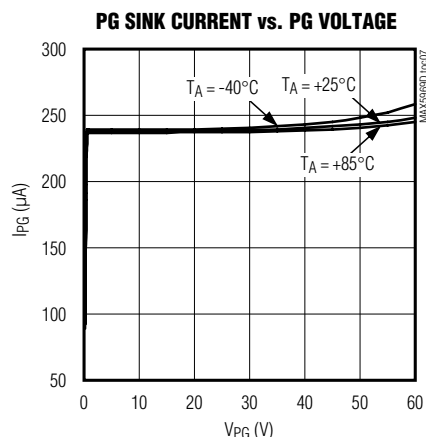
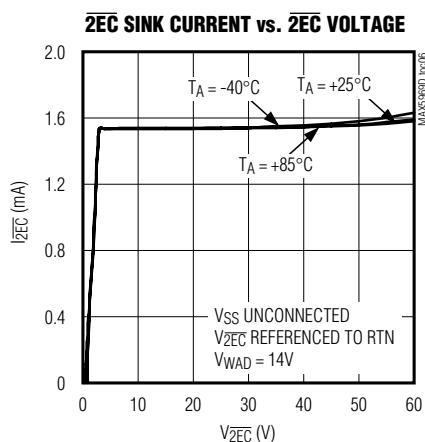
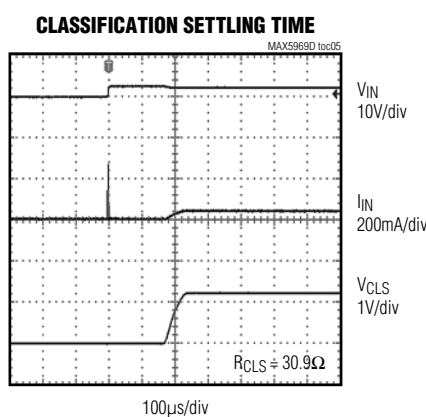
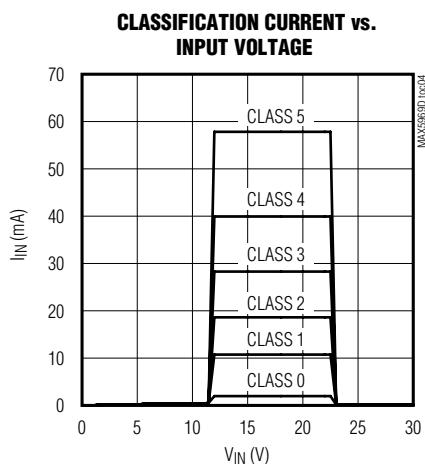
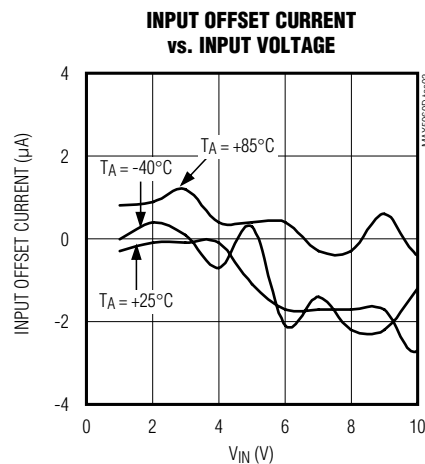
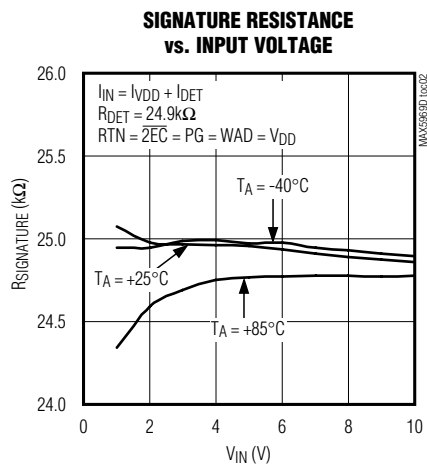
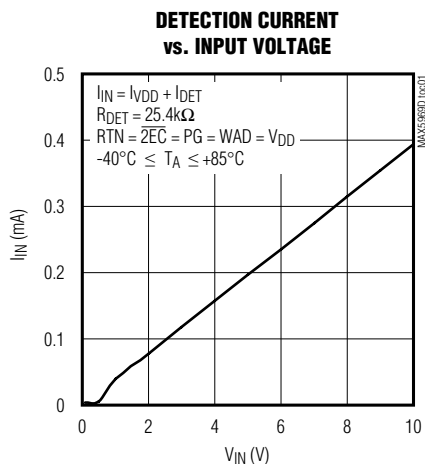

Figure 1. Effective Differential Input Resistance/Offset Current

# IEEE 802.3af/at-Compliant, Powered Device Interface Controller with Integrated Power MOSFET

## Typical Operating Characteristics

( $V_{IN} = (V_{DD} - V_{SS}) = 54V$ ,  $R_{DET} = 24.9k\Omega$ ,  $R_{CLS} = 615\Omega$ , and  $R_{SCL} = 60.4k\Omega$ .  $R_{TN}$ ,  $WAD$ ,  $PG$ , and  $\overline{2EC}$  unconnected; all voltages are referenced to  $V_{SS}$ .)



# IEEE 802.3af/at-Compliant, Powered Device Interface Controller with Integrated Power MOSFET

## Typical Operating Characteristics (continued)

( $V_{IN} = (V_{DD} - V_{SS}) = 54V$ ,  $R_{DET} = 24.9k\Omega$ ,  $R_{CLS} = 615\Omega$ , and  $R_{SL} = 60.4k\Omega$ .  $R_{TN}$ ,  $WAD$ ,  $PG$ , and  $\overline{2EC}$  unconnected; all voltages are referenced to  $V_{SS}$ .)

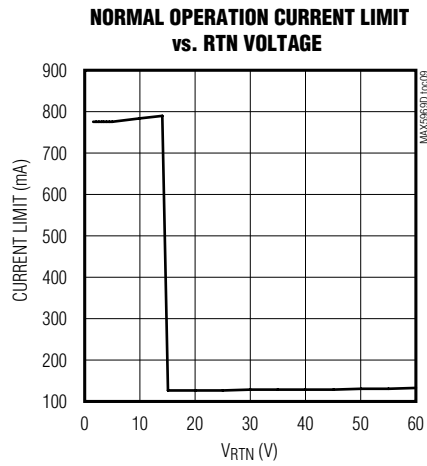
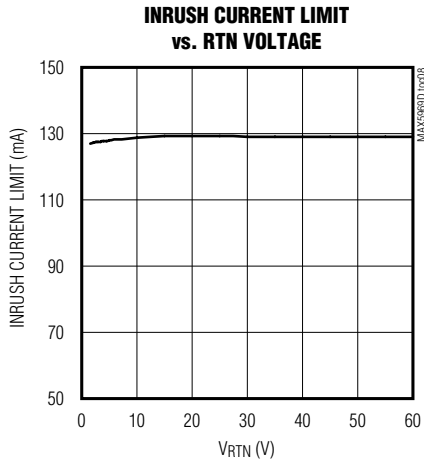

**INRUSH CONTROL WAVEFORM WITH TYPE 2 CLASSIFICATION**

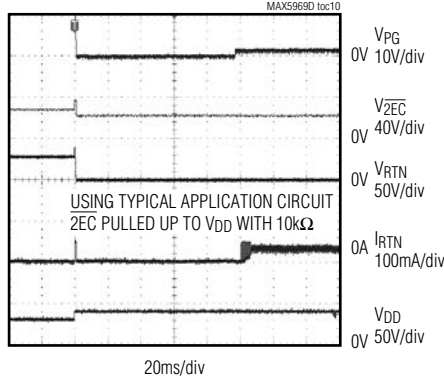

**INRUSH CONTROL WAVEFORM WITH TYPE 2 CLASSIFICATION**

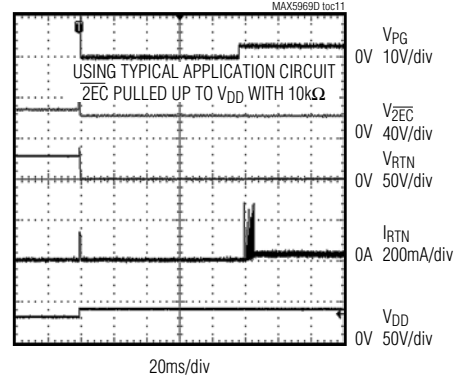

# IEEE 802.3af/at-Compliant, Powered Device Interface Controller with Integrated Power MOSFET

## Pin Configuration

**MAX5969D**

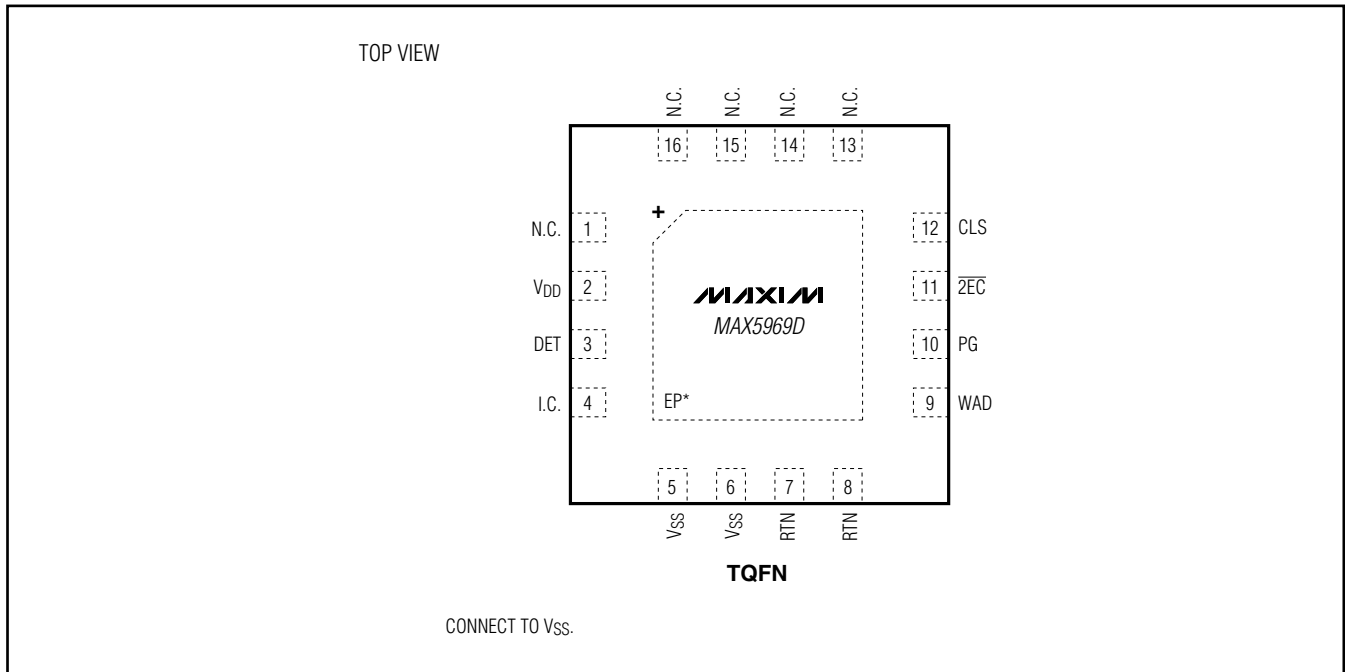

## Pin Description

PIN	NAME	FUNCTION
1, 13–16	N.C.	No Connection. Not internally connected. Leave N.C. unconnected.
2	V <sub>DD</sub>	Positive Supply Input. Connect a 68nF (min) bypass capacitor between V <sub>DD</sub> and V <sub>SS</sub> .
3	DET	Detection Resistor Input. Connect a signature resistor (R <sub>DET</sub> = 24.9kΩ) from DET to V <sub>DD</sub> .
4	I.C.	Internally Connected. Leave unconnected, leave I.C. unconnected.
5, 6	V <sub>SS</sub>	Negative Supply Input. V <sub>SS</sub> connects to the source of the integrated isolation n-channel power MOSFET.
7, 8	RTN	Drain of Isolation MOSFET. RTN connects to the drain of the integrated isolation n-channel power MOSFET. Connect RTN to the downstream DC-DC converter ground as shown in the <i>Typical Application Circuit</i> .

# IEEE 802.3af/at-Compliant, Powered Device Interface Controller with Integrated Power MOSFET

## Pin Description (continued)

PIN	NAME	FUNCTION
9	WAD	Wall Power Adapter Detector Input. Wall adapter detection is enabled the moment $V_{DD} - V_{SS}$ crosses the mark event threshold. Detection occurs when the voltage from WAD to RTN is greater than 9V. When a wall power adapter is present, the isolation n-channel power MOSFET turns off, $\overline{2EC}$ current sink turns on. Connect WAD directly to RTN when the wall power adapter or other auxiliary power source is not used.
10	PG	Open-Drain Power-Good Indicator Output. PG sinks 230 $\mu$ A to disable the downstream DC-DC converter while turning on the hot-swap MOSFET switch. PG current sink is disabled during detection, classification, and in the steady-state power mode. The PG current sink is turned on to disable the downstream DC-DC converter when the device is in sleep mode.
11	$\overline{2EC}$	2-Event Classification Detect or Wall Adapter Detect Output. A 1.5mA current sink is enabled at $\overline{2EC}$ when a Type 2 PSE or a wall adapter is detected. When powered by a Type 2 PSE, the $\overline{2EC}$ current sink is enabled after the isolation MOSFET is fully on until $V_{IN}$ drops below the UVLO threshold. $\overline{2EC}$ is latched when powered by a Type 2 PSE until $V_{IN}$ drops below the reset threshold. $\overline{2EC}$ also asserts when a wall adapter supply, typically greater than 9V, is applied between WAD and RTN. $\overline{2EC}$ is not latched if asserted by WAD. The $\overline{2EC}$ current sink is turned off when the device is in sleep mode.
12	CLS	Classification Resistor Input. Connect a resistor ( $R_{CLS}$ ) from CLS to $V_{SS}$ to set the desired classification current. See the classification current specifications in the <i>Electrical Characteristics</i> table to find the resistor value for a particular PD classification.
—	EP	Exposed Pad. Do not use EP as an electrical connection to $V_{SS}$ . EP is internally connected to $V_{SS}$ through a resistive path and must be connected to $V_{SS}$ externally. To optimize power dissipation, solder the exposed pad to a large copper power plane.



# IEEE 802.3af/at-Compliant, Powered Device Interface Controller with Integrated Power MOSFET

## Simplified Block Diagram

**MAX5969D**

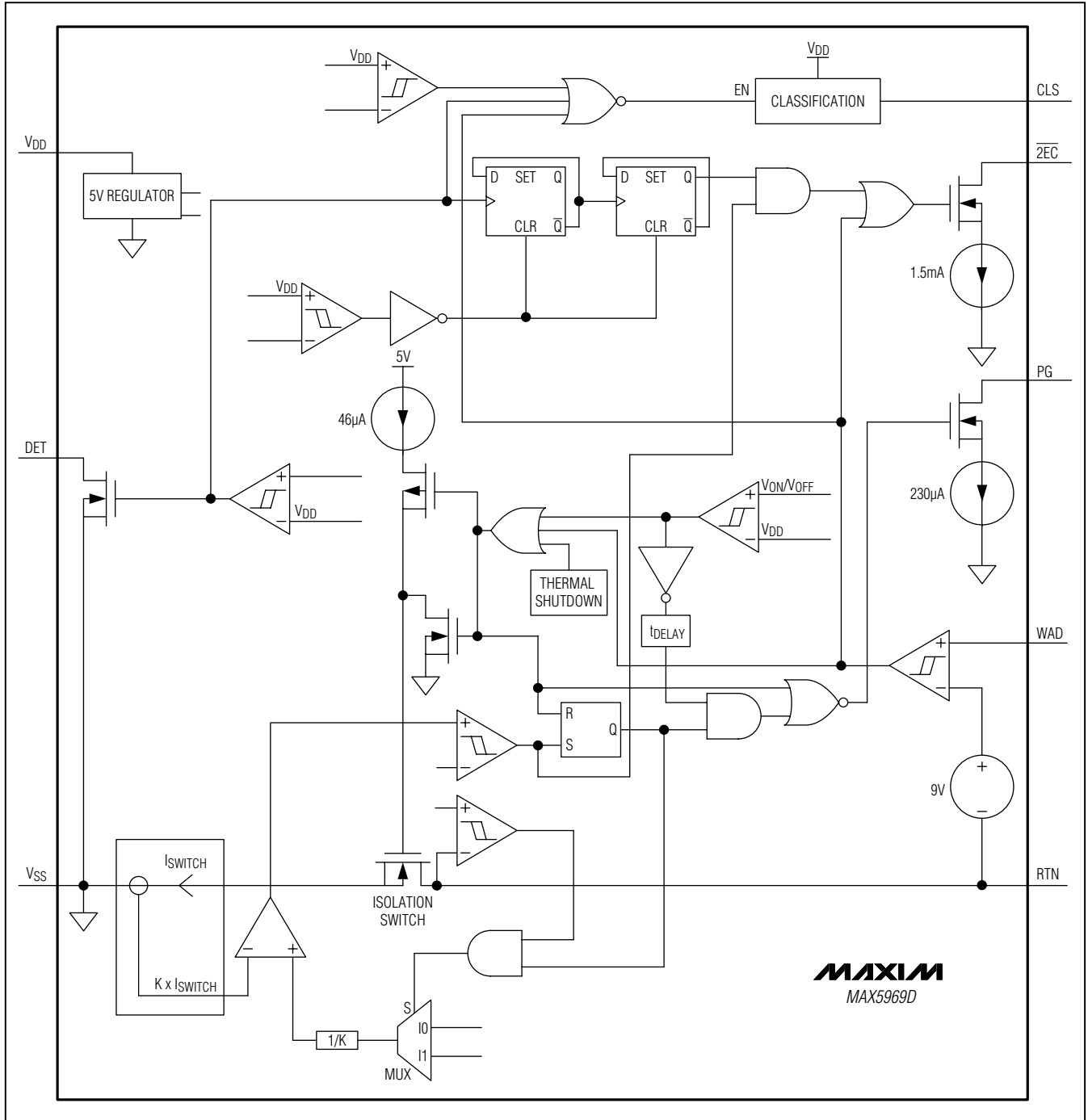

# IEEE 802.3af/at-Compliant, Powered Device Interface Controller with Integrated Power MOSFET

## Typical Operating Circuit

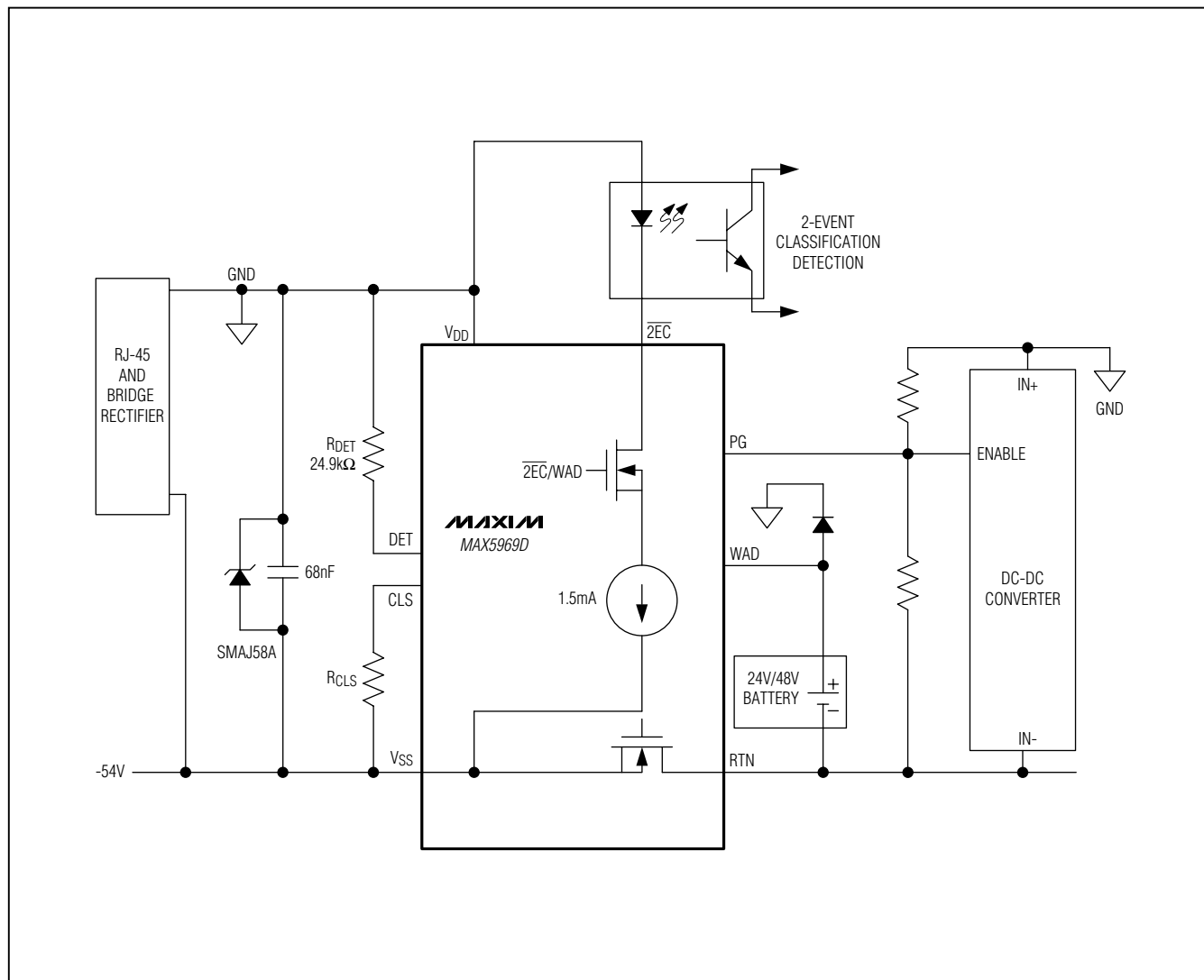

# IEEE 802.3af/at-Compliant, Powered Device Interface Controller with Integrated Power MOSFET

## Detailed Description

### Operating Modes

Depending on the input voltage ( $V_{IN} = V_{DD} - V_{SS}$ ), the MAX5969D operates in four different modes: PD detection, PD classification, mark event, and PD power. The device enters PD detection mode when the input voltage is between 1.4V and 10.1V. The device enters PD classification mode when the input voltage is between 12.6V and 20V. The device enters PD power mode once the input voltage exceeds  $V_{ON}$ .

#### Detection Mode ( $1.4V \leq V_{IN} \leq 10.1V$ )

In detection mode, the power source equipment (PSE) applies two voltages on  $V_{IN}$  in the 1.4V to 10.1V range (1V step minimum) and then records the current measurements at the two points. The PSE then computes  $\Delta V/\Delta I$  to ensure the presence of the 24.9k $\Omega$  signature resistor. Connect the signature resistor ( $R_{DET}$ ) from  $V_{DD}$  to DET for proper signature detection. The MAX5969D pulls DET low in detection mode. DET goes high impedance when the input voltage exceeds 12.5V. In detection mode, most of the MAX5969D internal circuitry is off and the offset current is less than 10 $\mu$ A.

If the voltage applied to the PD is reversed, install protection diodes at the input terminal to prevent internal damage to the MAX5969D (see the *Typical Application Circuit*). Since the PSE uses a slope technique ( $\Delta V/\Delta I$ ) to calculate the signature resistance, the DC offset due to the protection diodes is subtracted and does not affect the detection process.

#### Classification Mode ( $12.6V \leq V_{IN} \leq 20V$ )

In the classification mode, the PSE classifies the PD based on the power consumption required by the PD. This allows

the PSE to efficiently manage power distribution. Class 0–5 is defined as shown in Table 1. (The IEEE 802.3af/at standard defines only Class 0–4 and Class 5 for any special requirement.) An external resistor ( $R_{CLS}$ ) connected from CLS to  $V_{SS}$  sets the classification current.

The PSE determines the class of a PD by applying a voltage at the PD input and measuring the current sourced out of the PSE. When the PSE applies a voltage between 12.6V and 20V, the MAX5969D exhibits a current characteristic with a value shown in Table 1. The PSE uses the classification current information to classify the power requirement of the PD. The classification current includes the current drawn by  $R_{CLS}$  and the supply current of the MAX5969D so the total current drawn by the PD is within the IEEE 802.3af/at standard figures. The classification current is turned off whenever the device is in power mode.

#### 2-Event Classification and Detection

During 2-event classification, a Type 2 PSE probes PD for classification twice. In the first classification event, the PSE presents an input voltage between 12.6V and 20.5V and the MAX5969D presents the programmed load  $I_{CLASS}$ . The PSE then drops the probing voltage below the mark event threshold of 10.1V and the MAX5969D presents the mark current ( $I_{MARK}$ ). This sequence is repeated one more time.

When the MAX5969D is powered by a Type 2 PSE, the 2-event identification output  $\overline{2EC}$  asserts low after the internal isolation n-channel MOSFET is fully turned on.  $\overline{2EC}$  current sink is turned off when  $V_{DD}$  goes below the UVLO threshold ( $V_{OFF}$ ) and turns on when  $V_{DD}$  goes above the UVLO threshold ( $V_{ON}$ ), unless  $V_{DD}$  goes below  $V_{THR}$  to reset the latched output of the Type 2 PSE detection flag.

**Table 1. Setting Classification Current**

CLASS	MAXIMUM POWER USED BY PD (W)	$R_{CLS}$ ( $\Omega$ )	$V_{IN}^*$ (V)	CLASS CURRENT SEEN AT $V_{IN}$ (mA)		IEEE 802.3at PD CLASSIFICATION CURRENT SPECIFICATION (mA)	
				MIN	MAX	MIN	MAX
0	0.44 to 12.95	615	12.6 to 20	0	4	0	5
1	0.44 to 3.94	117	12.6 to 20	9	12	8	13
2	3.84 to 6.49	66.5	12.6 to 20	17	20	16	21
3	6.49 to 12.95	43.7	12.6 to 20	26	30	25	31
4	12.95 to 25.5	30.9	12.6 to 20	36	44	35	45
5	> 25.5	21.3	12.6 to 20	54	64	51	68

\* $V_{IN}$  is measured across the MAX5969D input  $V_{DD}$  to  $V_{SS}$ .

# IEEE 802.3af/at-Compliant, Powered Device Interface Controller with Integrated Power MOSFET

Alternatively, the  $\overline{2EC}$  output also serves as a wall adapter detection output when the MAX5969D is powered by an external wall power adapter. See the *Wall Power Adapter Detection and Operation* section for more information.

## Power Mode

The MAX5969D enters power mode when  $V_{IN}$  rises above the undervoltage lockout threshold ( $V_{ON}$ ). When  $V_{IN}$  rises above  $V_{ON}$ , the MAX5969D turns on the internal n-channel isolation MOSFET to connect  $V_{SS}$  to RTN with inrush current limit internally set to 135mA (typ). The isolation MOSFET is fully turned on when the voltage at RTN is near  $V_{SS}$  and the inrush current is reduced below the inrush limit. Once the isolation MOSFET is fully turned on, the MAX5969D changes the current limit to 800mA. The open-drain power-good output (PG) remains low for a minimum of  $t_{DELAY}$  until the power MOSFET fully turns on to keep the downstream DC-DC converter disabled during inrush.

## Undervoltage Lockout

The MAX5969D operates up to a 60V supply voltage with a turn-on UVLO threshold ( $V_{ON}$ ) at 35.4V and a turn-off UVLO threshold ( $V_{OFF}$ ) at 31V. When the input voltage is above  $V_{ON}$ , the MAX5969D enters power mode and the internal MOSFET is turned on. When the input voltage goes below  $V_{OFF}$  for more than  $t_{OFF\_DLY}$ , the MOSFET turns off.

## Power-Good Output

An open-drain output (PG) is used to allow disabling downstream DC-DC converter until the n-channel isolation MOSFET is fully turned on. PG is pulled low to  $V_{SS}$  for a period of  $t_{DELAY}$  and until the internal isolation MOSFET is fully turned on. The PG is also pulled low during sleep mode and coming out of thermal shutdown.

## Thermal-Shutdown Protection

The MAX5969D includes thermal protection from excessive heating. If the junction temperature exceeds the thermal-shutdown threshold of +140°C, the MAX5969D turns off the internal power MOSFET, LED driver, and  $\overline{2EC}$  current sink. When the junction temperature falls below +112°C, the devices enter inrush mode and then return

to power mode. Inrush mode ensures the downstream DC-DC converter is turned off as the internal power MOSFET is turned on.

## Wall Power Adapter Detection and Operation

For applications where an auxiliary power source such as a wall power adapter is used to power the PD, the MAX5969D features wall power adapter detection. The MAX5969D gives highest priority to the WAD and smoothly switch the power supply to WAD when it is detected. Once the input voltage ( $V_{DD} - V_{SS}$ ) exceeds the mark event threshold, the MAX5969D enables wall adapter detection. The wall power adapter is connected from WAD to RTN. The MAX5969D detects the wall power adapter when the voltage from WAD to RTN is greater than 9V. When a wall power adapter is detected, the internal n-channel isolation MOSFET turns off,  $\overline{2EC}$  current sink turns on, and classification current is disabled if  $V_{IN}$  is in the classification range.

## Applications Information

### Operation with 12V Adapter Layout Procedure

Careful PCB layout is critical to achieve high efficiency and low EMI. Follow these layout guidelines for optimum performance:

- 1) Place the input capacitor, classification resistor, and transient voltage suppressor as close as possible to the MAX5969D.
- 2) Use large SMT component pads for power dissipating devices such as the MAX5969D and the external diodes.
- 3) Use short and wide traces for high-power paths.
- 4) Use the MAX5969 evaluation kit layout as a reference.
- 5) Place enough vias in the pad for the EP of the MAX5969D so that heat generated inside can be effectively dissipated by the PCB copper. The recommended spacing for the vias is 1mm to 1.2mm pitch. The thermal vias should be plated (1oz copper) and have a small barrel diameter (0.3mm to 0.33mm).

# IEEE 802.3af/at-Compliant, Powered Device Interface Controller with Integrated Power MOSFET

**MAX5969D**

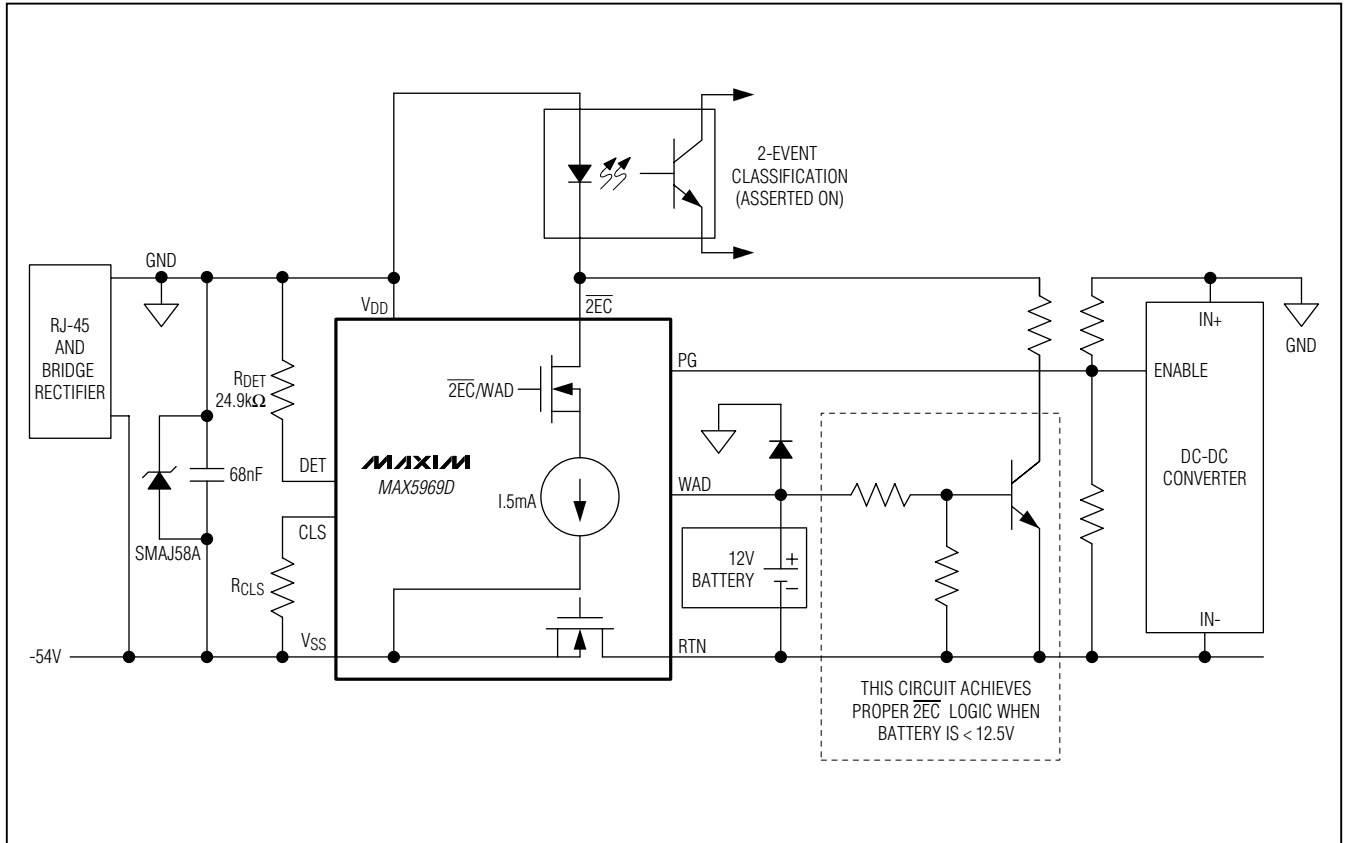
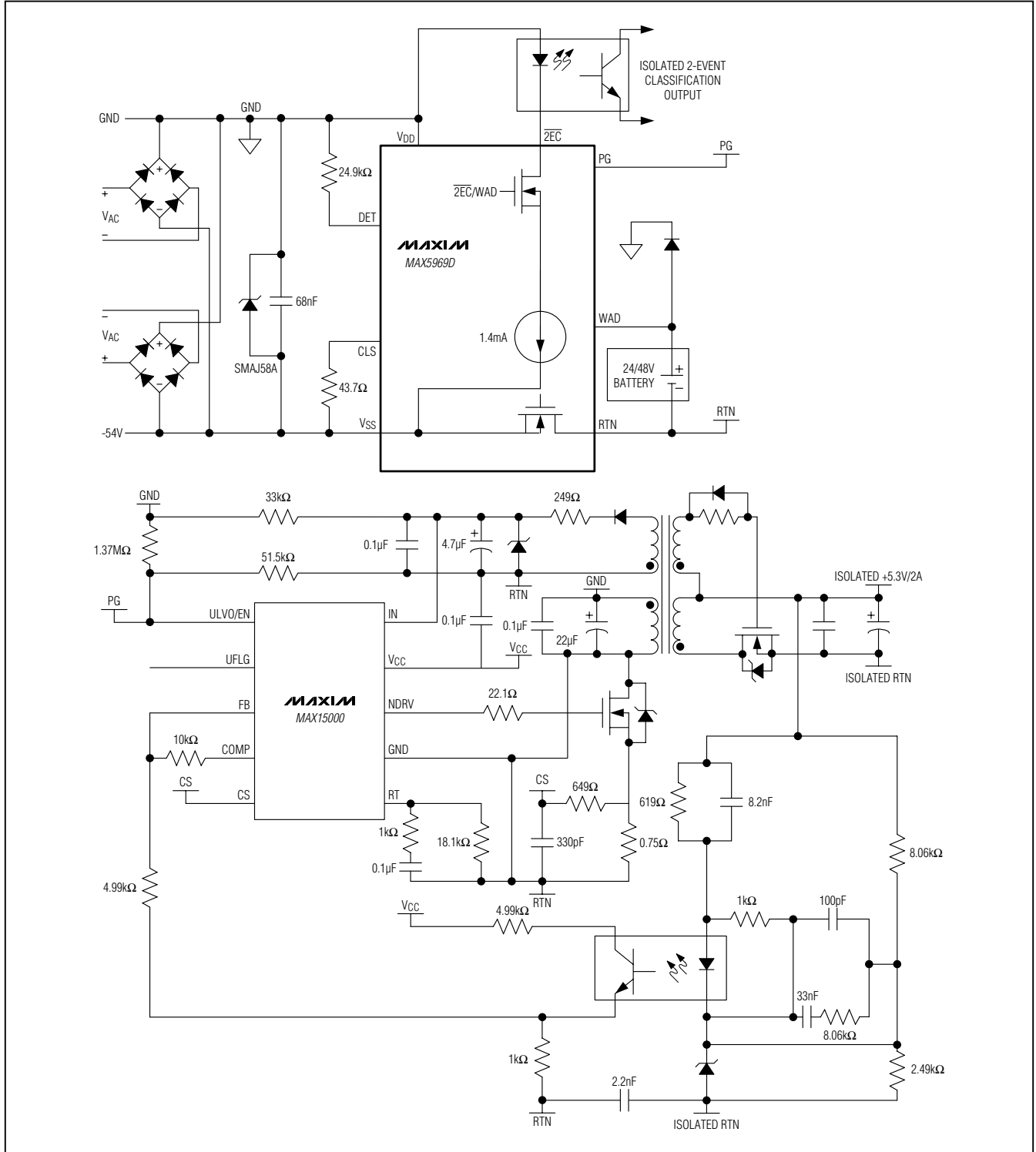

Figure 2. Typical Configuration When Using a 12V Wall Power Adapter

# IEEE 802.3af/at-Compliant, Powered Device Interface Controller with Integrated Power MOSFET

## Typical Application Circuit



# IEEE 802.3af/at-Compliant, Powered Device Interface Controller with Integrated Power MOSFET

**MAX5969D**

## Chip Information

PROCESS: BiCMOS

## Package Information

For the latest package outline information and land patterns (footprints), go to [www.maxim-ic.com/packages](http://www.maxim-ic.com/packages). Note that a "+", "#", or "-" in the package code indicates RoHS status only. Package drawings may show a different suffix character, but the drawing pertains to the package regardless of RoHS status.

PACKAGE TYPE	PACKAGE CODE	OUTLINE NO.	LAND PATTERN NO.
16 TQFN-EP	T1655+4	<a href="#">21-0140</a>	<a href="#">90-0121</a>

# **IEEE 802.3af/at-Compliant, Powered Device Interface Controller with Integrated Power MOSFET**

## **Revision History**

<b>REVISION NUMBER</b>	<b>REVISION DATE</b>	<b>DESCRIPTION</b>	<b>PAGES CHANGED</b>
0	6/11	Initial release	—

*Maxim cannot assume responsibility for use of any circuitry other than circuitry entirely embodied in a Maxim product. No circuit patent licenses are implied. Maxim reserves the right to change the circuitry and specifications without notice at any time. The parametric values (min and max limits) shown in the Electrical Characteristics table are guaranteed. Other parametric values quoted in this data sheet are provided for guidance.*

16 **Maxim Integrated Products, 120 San Gabriel Drive, Sunnyvale, CA 94086 408-737-7600**



## X-ON Electronics

Largest Supplier of Electrical and Electronic Components

*Click to view similar products for [Hot Swap Voltage Controllers](#) category:*

*Click to view products by [Maxim](#) manufacturer:*

Other Similar products are found below :

[LTC4227CUFD-4#PBF](#) [LTC4212IMS](#) [ADM1075-2ARUZ-RL7](#) [LM5067MW-1/NOPB](#) [ADM1075-1ARUZ-RL7](#) [MAX5969BETB+T](#)  
[MIC22700YML-TR](#) [LTC4223CDHD-1#PBF](#) [MAX40200AUK+T](#) [LTC4224IDDB-2#TRMPBF](#) [LT1640LIS8#PBF](#) [LTC4217CDHC-12#PBF](#)  
[LT1640ALCS8#PBF](#) [LT4294HDD#PBF](#) [LTC4253CGN#PBF](#) [LTC4211CMS8#PBF](#) [LTC4230CGN#PBF](#) [LTC4224IMS-1#PBF](#)  
[LTC4216IMS#PBF](#) [LTC4212IMS#PBF](#) [LTC4260CGN#PBF](#) [LTC4227CGN-2#PBF](#) [LTC4244IGN#PBF](#) [LTC4212CMS#PBF](#)  
[LT4250HCN8#PBF](#) [ADM1276-3ACPZ-RL](#) [LTC4226IUD-1#PBF](#) [LT1640AHCN8](#) [ADM1075-2ACPZ](#) [ADM1075-1ACPZ](#) [ADM1073ARUZ](#)  
[ADM1073ARUZ-REEL7](#) [ADM1075-1ARUZ](#) [ADM1075-2ARUZ](#) [ADM1170-1AUJZ-RL7](#) [ADM1171-2AUJZ-RL7](#) [ADM1172-1AUJZ-RL7](#)  
[ADM1172-2AUJZ-RL7](#) [ADM1176-1ARMZ-R7](#) [ADM1177-1ARMZ-R7](#) [ADM1177-2ARMZ-R7](#) [ADM1178-1ARMZ-R7](#) [ADM1275-3ARQZ](#)  
[ADM1275-1ARQZ](#) [ADM1275-3ARQZ-R7](#) [ADM1276-3ACPZ](#) [ADM1278-1BCPZ](#) [ADM4210-1AUJZ-RL7](#) [ADM1270ARQZ](#) [ADM1275-2ARQZ](#)