

## MAX5992A Evaluation Kit

Evaluates: MAX5992A  
MAX5992B

### General Description

The MAX5992A/B evaluation kit (EV kit) is a fully assembled and tested surface-mount circuit board featuring the MAX5992A/B IEEE® 802.3af/at-compliant network powered device (PD) interface controller IC, which provides PD detection signature, PD classification signature, inrush current control, undervoltage lockout (UVLO), and active FET-bridge driver. The EV kit is a compact and low-cost design used in power-over-Ethernet (PoE) applications requiring DC power from an Ethernet network port for PDs, such as fiber-to-the-femtocell/picocell/microcell, fiber-to-the-home/fiber-to-the-building (FTTH/FTTB), IP phones, wireless access nodes, and security cameras.

The EV kit features a 2x2P PD or multi-PD redundancy configuration using the ICs. The 2x2P powers a galvanically isolated 100W, 250kHz switching-frequency, active-clamped, synchronous-rectified forward DC-DC converter using the MAX5974D. The device circuit achieves high efficiency by using a forward DC-DC converter topology. The surface-mount transformer provides up to +1500V galvanic isolation for the output. The EV kit output voltage is configured for +12V and provides up to 8.4A load current.

**Note:** In the multi-PD redundancy mode, the total output power must be reduced to 50W, which is limited by the LAN transformer on board. Its port current must be limited to 1.2A per 2 pair.

The EV kit circuit receives its power from IEEE 802.3af/at-compliant power-sourcing equipment (PSE). The PSE provides the required -44V to -57V DC power over a twisted-pair Ethernet network cable to the EV kit's RJ45 connectors. The EV kit features an active FET bridge for separating the DC power provided by an end-span or mid-span Ethernet system.

**Warning:** The EV kit is designed to operate with high voltages. Dangerous voltages are present on this EV kit and on equipment connected to it. Users who power up this EV kit, or power the sources connected to it, must be careful to follow safety procedures appropriately to work with high-voltage electrical equipment.

Under severe fault or failure conditions, this EV kit may dissipate large amounts of power, which could result in the mechanical ejection of a component or of component debris at high velocity. Operate this kit with care to avoid possible personal injury.

### Features

- IEEE 802.3af/at-Compliant PD Interface Circuit
- -39V to -57V Startup Input Voltage Range
- Active FET Bridge
- Demonstrates 2x2P PD and Multi-PD Redundancy Configurations
- Demonstrates an Isolated 100W Active-Clamped, Synchronous-Rectified Forward DC-DC Converter
- Isolated +12V Output at 8.4A
- PD Detection and Configurable Classification Signatures
- Internal UVLO at +38.6V
- Evaluates End Span and Midspan Ethernet Systems
- Proven PCB Layout
- Fully Assembled and Tested

Ordering Information appears at end of data sheet.

## Quick Start

### Required Equipment

- MAX5992A/B EV kit
- MAX5980 EV kit
- IEEE 802.3af/at-compliant PSE and Category 5e Ethernet network cable
- Two -54V, 15A-capable DC power supply
- Voltmeter

### Procedure

The EV kit is fully assembled and tested. Follow the steps below to verify board operation. **Caution: Do not turn on the power supply until all connections are completed.**

- 1) Use one of the following methods to power the EV kit:
  - a) **If network connectivity is required:** Connect a Category 5e ethernet network cable from the EV kit input port's RJ45 connectors (J1\_POWER, J2\_POWER) to the corresponding PSE ethernet LAN connections, which provide power to the EV kit. Two modular RJ45 jacks (J1\_DATA, J2\_DATA) provide an interface with the ethernet data signals only.
  - b) **If network connectivity is not required:** Connect a -54V DC power supply between the -54V1, -54V2, and GND PCB pads on the EV kit. Connect the power-supply positive terminal to the V+ PCB pad and the negative terminal to the V- PCB pad.
- 2) Activate the PSE power supply or turn on the external DC power supply.
- 3) Using a voltmeter, verify that the EV kit provides +12V across the V<sub>OUT</sub> and RTN PCB pads.

## Detailed Description of Hardware (or Software)

The MAX5992A/B EV kit is a fully assembled and tested surface-mount circuit board that evaluates the MAX5992A/B IEEE 802.3af/at-compliant network PD interface controller. The EV kit features two powered Ethernet ports, two data-only Ethernet ports, and a MAX5974D active-clamped, current-mode PWM controller IC.

The EV kit is a 2x2P PD configuration PoE using the PD controller IC. The 2x2P PD interface powers a galvanically isolated 100W DC-DC converter using the MAX5974D active-clamped, current-mode PWM controller IC in a forward-feedback topology. The EV kit receives power from two IEEE 802.3af/at-compliant PSEs and two UTP cables connected to the EV kit's RJ45 connectors. The EV kit accepts power from an endspan or midspan PSE network configuration. The EV kit also provides Ethernet jacks J1\_DATA and J2\_DATA for interfacing to the Ethernet data signals. PCB pads -54V1, -54V2, and GND are available for powering the EV kit, if network connectivity is not required.

The EV kit output voltage is configured for +12V and provides up to 8.4A output current. The EV kit circuit use MOSFETs N1 and N2 for synchronous rectification on the secondary side. Transformer T1 provides up to 1500V galvanic isolation for the output. Isolated feedback voltage is achieved using optocoupler U4 and voltage reference U5. Current-sense resistors R45 and R46 limit the peak current through transistor N7 and primary transformer T1. Capacitor C14 and transistor N12 form a clamping network that protects transformer T1 against saturation due to reverse current, by monitoring the voltage across the MAX5974D's CS input during auxiliary driver N4 off-time.

The EV kit accommodates mainly two applications to exercise: 2x2P and multi-PD redundancy. As a default, the EV kit is set to 2x2P. Besides these two configurations, single PD operation can be configured, but power is limited by the current capability of the LAN transformer, which supports up to 1.2A per 2P.

In the 2x2P application, there are sets of PoE power lines. Each PSE has its own PD. The PSEs are all connected to the same power supply. The two PoE sets share the same Ethernet cable. [Figure 1](#) is the system-level diagram. To test the EV kit in 2x2P, the MAX5980A EV kit needs to be reconfigured into 2x2P mode accordingly. Refer to the MAX5980 EV kit data sheet for more details.

In multi-PD redundancy mode, the PSEs are independent. The input voltages of each PSE can be different. Each PSE is connected to its PD through an independent ethernet cable (see [Figure 1](#)).

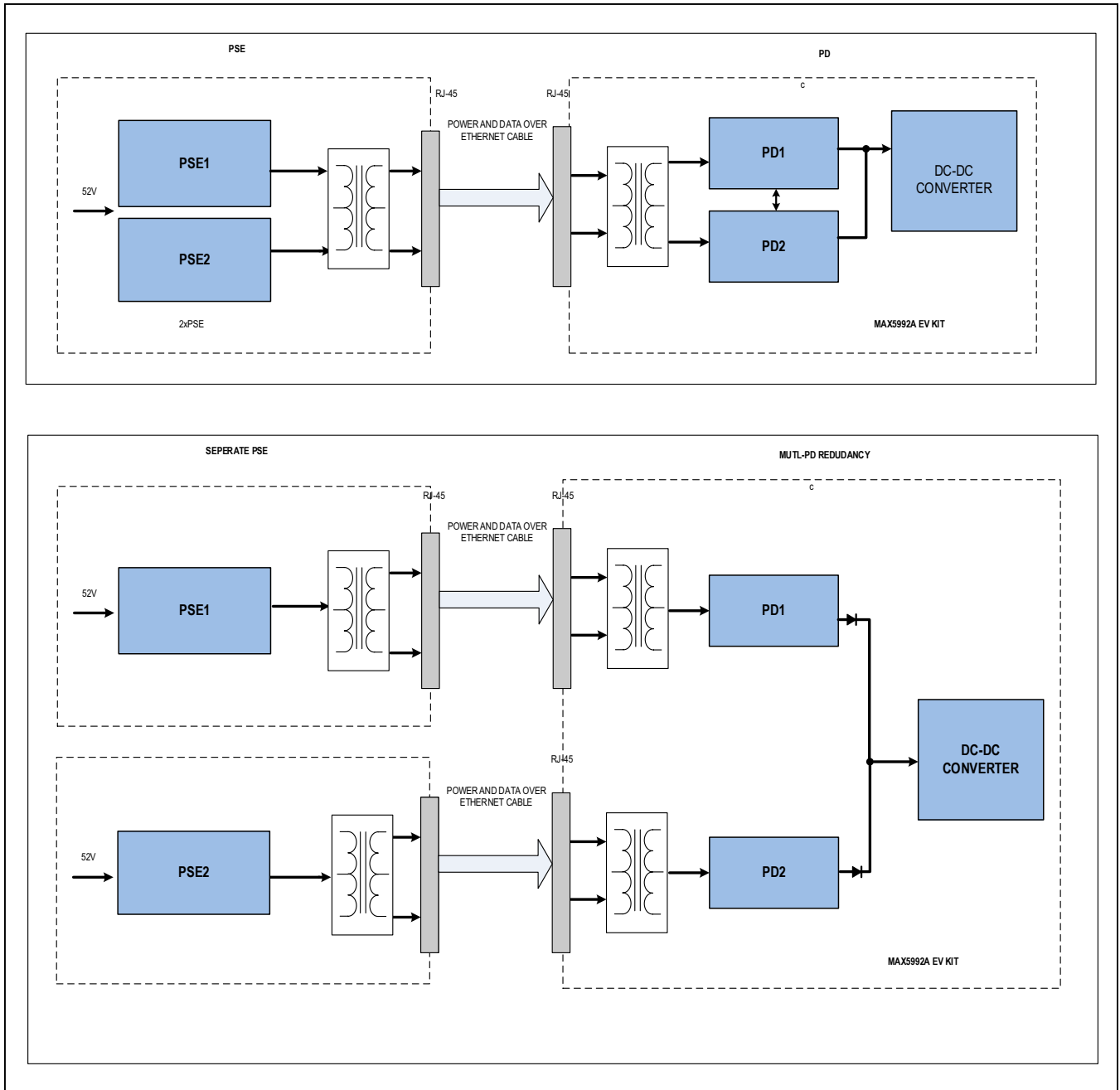

Figure 1. 2x2P Application, Multi-PD Redundancy

**2x2P PD Configuration**

Jumper JU1 sets the 2x2P PD configuration of the devices. See [Table 1](#) for shunt positions.

**Power Good (PG)**

Jumper JU2 sets the PG output for 2x2P PD and multi-PD configurations. See [Table 2](#) for shunt positions.

**Multi-PD Redundancy Configuration**

The EV kit provides an option to configure for multi-PD redundancy operation. Set jumpers JU1, JU2 accordingly and remove resistors R116, R117 for redundancy configuration.

Jumper JU3 sets the multi-PD redundancy configuration of U1. See [Table 3](#) for shunt positions.

Jumper JU4 sets the multi-PD redundancy configuration of U2. See [Table 4](#) for shunt positions.

**PD Classification Signature**

The EV kit is configured for a Class 5 (> 25.5W) PD classification by resistors R51 and R56. To reconfigure the PD classification, replace the surface-mount 0805 resistors, R51 and R56. [Table 5](#) lists the PD classification options.

**Table 1. JU1 Jumper Selection (SIG\_OK)**

SHUNT POSITION	SIG_OK PINS	2x2P PD CONFIGURATION
Installed*	U1 SIG_OK connects to U2 SIG_OK	Enabled
Not installed	U1 SIG_OK and U2 SIG_OK unconnected	Disabled

**Table 2. JU2 Jumper Selection (PG)**

SHUNT POSITION	PG PINS	2x2P PD AND MULTI-PD CONFIGURATION
Installed*	U1 PG connects to U2 PG	2x2 PD and multi-PD
Not installed	U1 PG and U2 PG unconnected	Operate with U1 only

**Table 3. JU3 Jumper Selection (RDCY\_SEL of U1)**

SHUNT POSITION	RDCY_SEL PIN (U1)	MULTI-PD REDUNDANCY CONFIGURATION
Installed	Forced to -54V1	Enabled
Not installed*	Unconnected	Disabled

**Table 4. JU4 Jumper Selection (RDCY\_SEL of U2)**

SHUNT POSITION	RDCY_SEL PIN (U1)	MULTI-PD REDUNDANCY CONFIGURATION
Installed	Forced to -54V2	Enabled
Not installed*	Unconnected	Disabled

**Table 5. PD Classification Signature Selection**

CLASS	MAXIMUM POWER USED BY PD (W)	RESISTORS R51, R56(Ω)
0	0.44 to 12.95	615
1	0.44 to 3.84	118
2	3.84 to 6.49	69.8
3	6.49 to 12.95	45.3
4	12.95 to 25.5	30.9
5	> 25.5	21.5

## Component Suppliers

SUPPLIER	WEBSITE
Coilcraft, Inc.	<a href="http://www.coilcraft.com">www.coilcraft.com</a>
Diodes Incorporated	<a href="http://www.diodes.com">www.diodes.com</a>
Fairchild Semiconductor	<a href="http://www.fairchildsemi.com">www.fairchildsemi.com</a>
Johanson Dielectrics	<a href="http://www.johansondielectrics.com">www.johansondielectrics.com</a>
KEMET Corp	<a href="http://www.kemet.com">www.kemet.com</a>
Murata Electronics North America, Inc.	<a href="http://www.murata-northamerica.com">www.murata-northamerica.com</a>
NEC Corp.	<a href="http://www.nec.com">www.nec.com</a>
Panasonic Corp	<a href="http://www.panasonic.com">www.panasonic.com</a>
Pulse Engineering	<a href="http://www.pulseeng.com">www.pulseeng.com</a>
SANYO Electric Co., Ltd.	<a href="http://www.sanyo.com">www.sanyo.com</a>
Sumida Corp.	<a href="http://www.sumida.com">www.sumida.com</a>
TDK Corp.	<a href="http://www.component.tdk.com">www.component.tdk.com</a>
Texas Instruments Inc.	<a href="http://www.ti.com">www.ti.com</a>
Vishay	<a href="http://www.vishay">www.vishay</a>

**Note:** Indicate that you are using the MAX5992A when contacting these component suppliers.

## Ordering Information

PART	TYPE
MAX5992AEVKIT#	EV Kit

#Denotes an RoHS-compliant device that may include lead(Pb) that is exempt under the RoHS requirements.

**MAX5992A EV Kit Bill of Materials**

DESIGNATION	QTY	DESCRIPTION
C1	1	1µF ±10%, 16V X7R ceramic capacitor (0805) Murata GRM21BR71C105K TDK C2012X7R1C105K
C11, C31, C36	4	100pF ±5%, 50V C0G ceramic capacitors (0603) Murata GRM1885C1H101J
C5, C10	3	0.047µF, 50V X7R ceramic capacitors (0603) Murata GRM188R71H473K
C4, C32	2	0.01µF, 50V X7R ceramic capacitors (0603) Murata GRM188R71H103K
C6	1	1µF ±10%, 16V X7R ceramic capacitor (0603) Murata GRM188R71C105K TDK C1608X7R1C105K
C7, C8, C13	3	2.2µF ±10%, 100V ceramic capacitors (1210) TDK C3225X7R2A225K Murata GRM32ER72A225K
C9, C25, C23	3	0.1µF ±10%, 50V X7R ceramic capacitors (0603) Murata GRM188R71H104K
C12, C15	2	0.1µF ±10%, 100V X7R ceramic capacitors (1206) KEMET C1206C104K1RACTU
C14	1	0.047µF ±10%, 250V X7R ceramic capacitor (1206) Murata GRM31CR72E473K TDK C3216X7R2E473K
C19	1	220pF ±10%, 250V X7R ceramic capacitor (0603) Murata GRM188R72E221K
C26	1	100µF, 16V polymer tantalum capacitor SANYO 16TQC100M KEMET T521D107M016ATE050
C27–C30, C34	5	22µF ±10%, 16V X5R ceramic capacitors (1206) Murata GRM31CR61C226K
C35, C40, C42, C43	0	Not installed, ceramic capacitors (0603)

DESIGNATION	QTY	DESCRIPTION
C38	1	33µF, 100V aluminum electrolytic capacitor (8.3mm x 8.3mm) Panasonic EEE-FK2A330P
C39	1	4700pF ±10%, 50V X7R ceramic capacitor (0603) Murata GRM188R71H472K
C41	1	2200pF ±10%, 50V X7R ceramic capacitor (0603) Murata GRM188R71H222K
C45	1	2200pF, 2000V X7R ceramic capacitor (1808) Johanson 202R29W222KV4
C50–C53, C56–C59, C80–C87	16	0.01µF, 100V X7R ceramic capacitors (0805) Murata GRM21BR72A103K
C54, C55, C60, C88–C90	6	1000pF ±10% 250V X7R ceramic capacitors (1808) Murata GA352QR7GF102K
D1	1	10V zener diode (SOD323) Diodes Inc. BZT52C10S-7-F
D2, D6	2	16V zener diodes (SOD323) Diodes Inc. BZT52C16S-7-F
D3, D4, D8, D10	4	250V, 200mA diodes (SOD323) Diodes Inc. BAV21WS-7-F
D5, D9	2	75V, 200mA diodes (SOD323) Diodes Inc. BAV16WS-7-F
D7	1	120V, 400W TVS diode Diodes Inc. SMAJ120A-13-F
D13, D14	2	Transient voltage suppressors (SMB) Diodes Inc. SMBJ58A (Top Mark: NG)
D15, D16	2	100V, 2A diodes (SMB) Fairchild S2B
J1_Data, J1_Power, J2_Data, J2_Power	4	8-position, side-entry modular jack assemblies
JU1–JU4	4	2-pin headers
L1	1	1000µH, 100mA inductor (4mm x 4mm) Coilcraft LPS4018-105ML_
L2	1	2.3µH, 7A inductor (6.8mm x 6.8mm) Pulse PG0083.232

MAX5992A EV Kit Bill of Materials (continued)

DESIGNATION	QTY	DESCRIPTION
L3	1	4.7µH, 15A inductor (14.9mm x 14.9mm) Sumida CDEP147NP-4R7MC-95
N1–N4	4	80V, 4.3A/2.8A n-/p-channel MOSFETs (4 DPAK) Fairchild FDD3510H
N5, N6	2	100V, 7A n-channel MOSFETs (8 SO) Fairchild FDS86141
N7	1	150V, 7.2A n-channel MOSFET (PowerPak, 8 SO) Vishay Si7430DP or Fairchild FDMS2572
N8, N10, N13	0	Not installed, MOSFETs (PowerPak, 8 SO)
N9, N11	2	100V, 17.6A n-channel MOSFETs (PowerPak, 8 SO) Vishay SiR882DP
N12	1	150V, -1.9A p-channel MOSFET (PowerPak, 1212-8) Vishay Si7115DN
Q1	1	80V, 1A npn transistor Diodes Inc. BCX56
Q2	1	40V, 600mA pnp transistor Diodes Inc. MMBT4403-7-F
R1	1	316kΩ ±1% resistor (0805)
R2	1	100kΩ ±1% resistor (0805)
R3	1	1.5kΩ ±1% resistor (0603)
R4, R14, R31, R33, R39	1	10kΩ ±1% resistors (0603)
R5, R36	2	75kΩ ±1% resistors (0603)
R6, R12, R47, R48, R52–R54, R57–R59	0	Not installed, resistors (0603)
R7	1	30kΩ ±1% resistor (0603)
R8	1	0Ω ±5% resistor (0603)
R10	1	51kΩ ±1% resistor (0805)
R13, R41–R43	4	3Ω ±5% resistor (0603)
R16	1	3.6kΩ ±1% resistor (0603)
R17, R30	2	1kΩ ±1% resistors (0603)
R18	1	42.2kΩ ±1% resistor (0603)
R19	1	200kΩ ±1% resistor (0603)

DESIGNATION	QTY	DESCRIPTION
R20	1	510Ω ±1% resistor (0603)
R24	1	200Ω ±1% resistor (1206)
R25, R29	2	200Ω ±1% resistors (0603)
R26	1	120kΩ ±1% resistor (0603)
R32	1	2kΩ ±1% resistor (0603)
R34	1	3.3kΩ ±1% resistor (0603)
R35	1	13kΩ ±1% resistor (0603)
R37	1	10Ω ±1% resistor (0603)
R45, R46	2	40mΩ ±1%, 1/2W resistors (1206) TT Electronics LR1206-R04FW
R55	2	25.5kΩ ±1% resistors (0603)
R56	2	21.5Ω ±1% resistors (0805)
R60, R61	2	0.1Ω ±1%, 1/2W resistors (1206) Panasonic-ECG ERJ-8BWFR100V
R63–R66, R74–R77, R108–R115	16	75Ω ±5% resistors (0805)
R70–R73	4	1kΩ ±5% resistors (0603)
T2	1	LAN transformer Sumida CLP176
TP1	1	Red test point
TP2	1	Black test point
U1_EN, U1_GEN, U1_LED, U1_SL, U1_2EC, U2_EN, U2_GEN, U2_LED, U2_SL, U2_2EC	0	Not installed, test points
U1, U2	2	High-power PD controllers (24 TQFN-EP*) Maxim MAX5992A/BETG+
U3	1	Active-clamped, current-mode PWM controller (16 TQFN-EP*) Maxim MAX5974DETE+
U4	1	Optocoupler (4 SSOP) NEC PS2801-1-F4-A-L
U5	1	2.5V voltage reference (SOT23) TI TL432BIDBZ
—	1	PCB: MAX5992A/B EVALUATION KIT

MAX5992A EV Kit Schematics

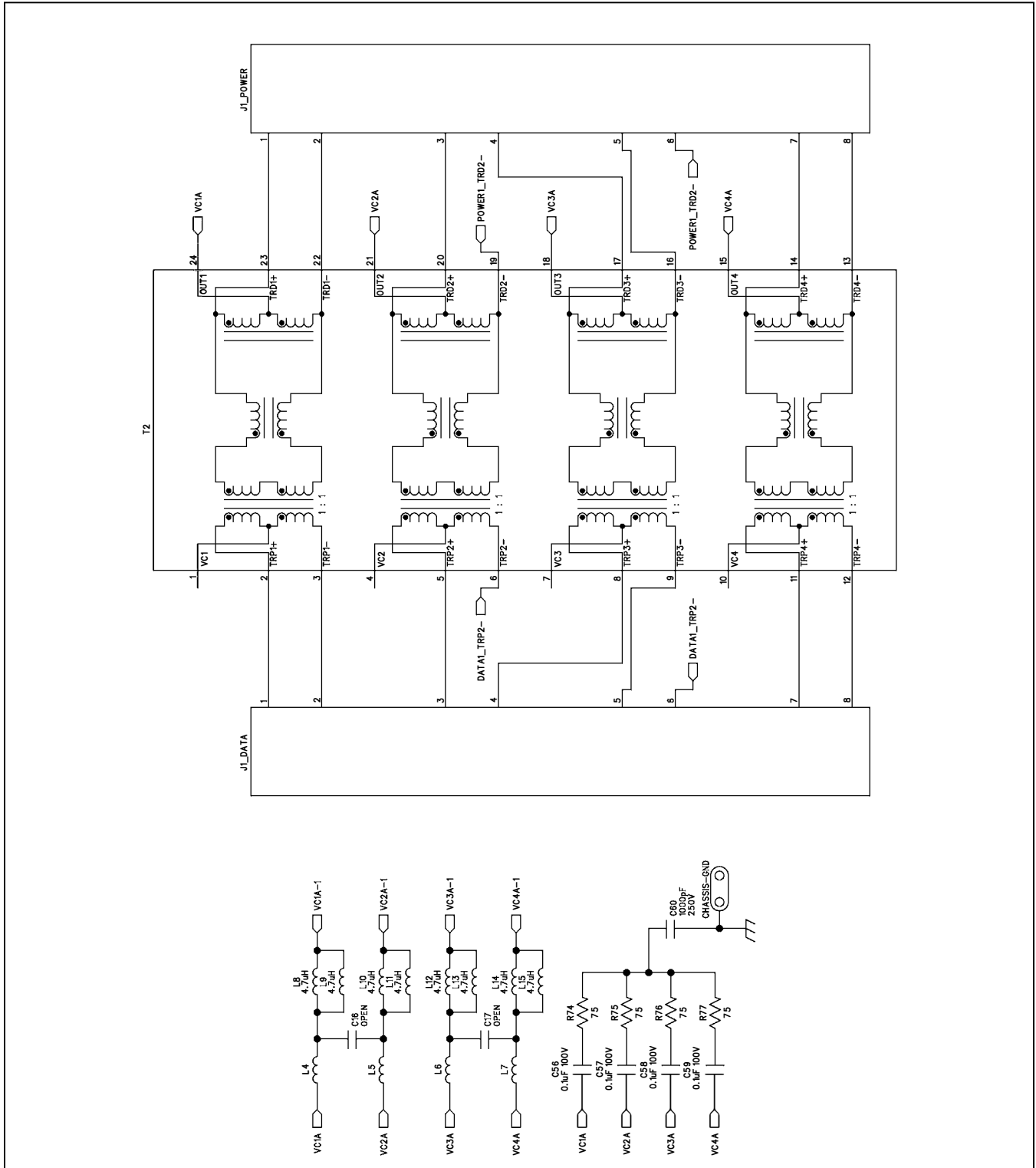



MAX5992A EV Kit Schematics (continued)

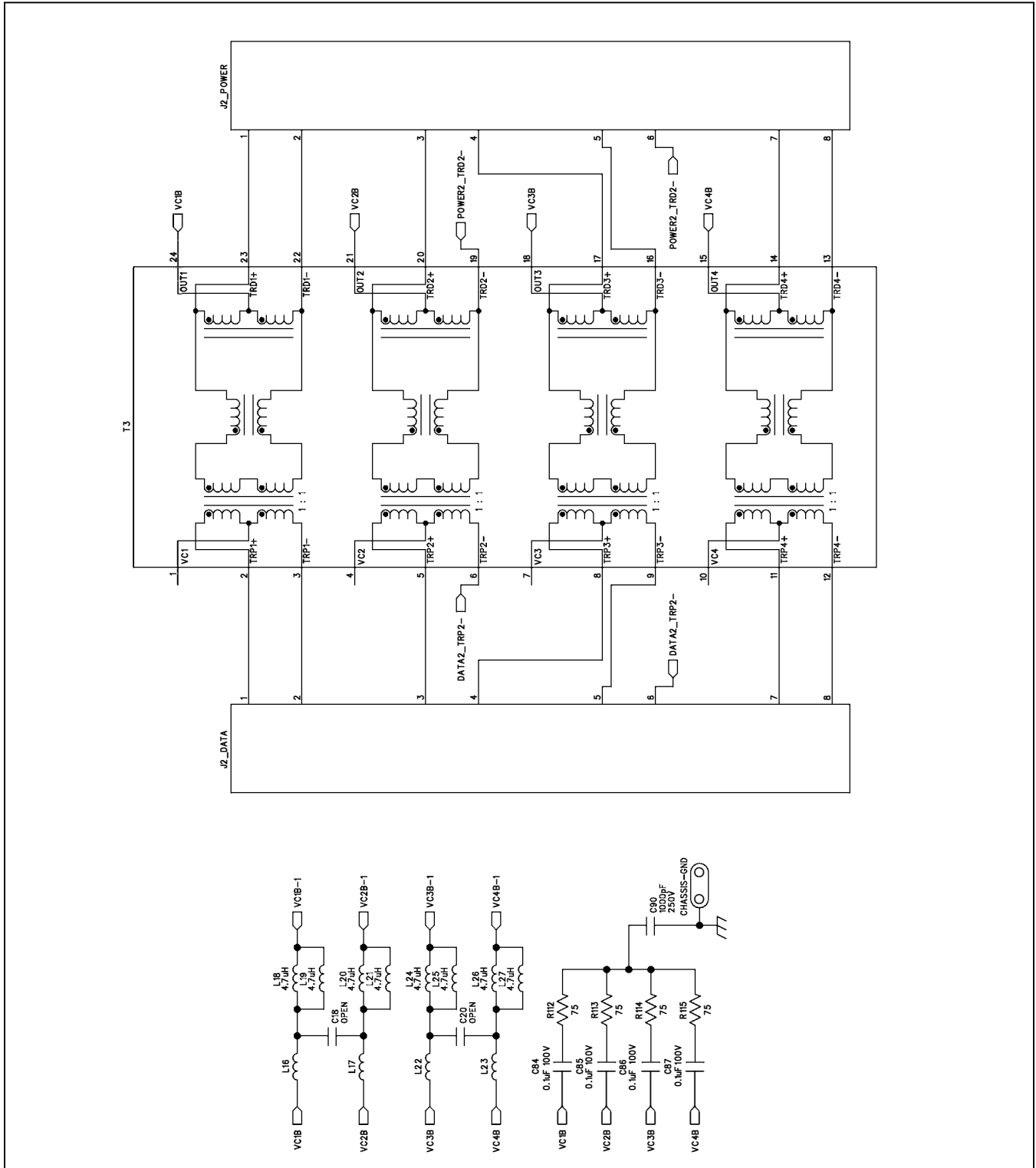

MAX5992A EV Kit Schematics (continued)

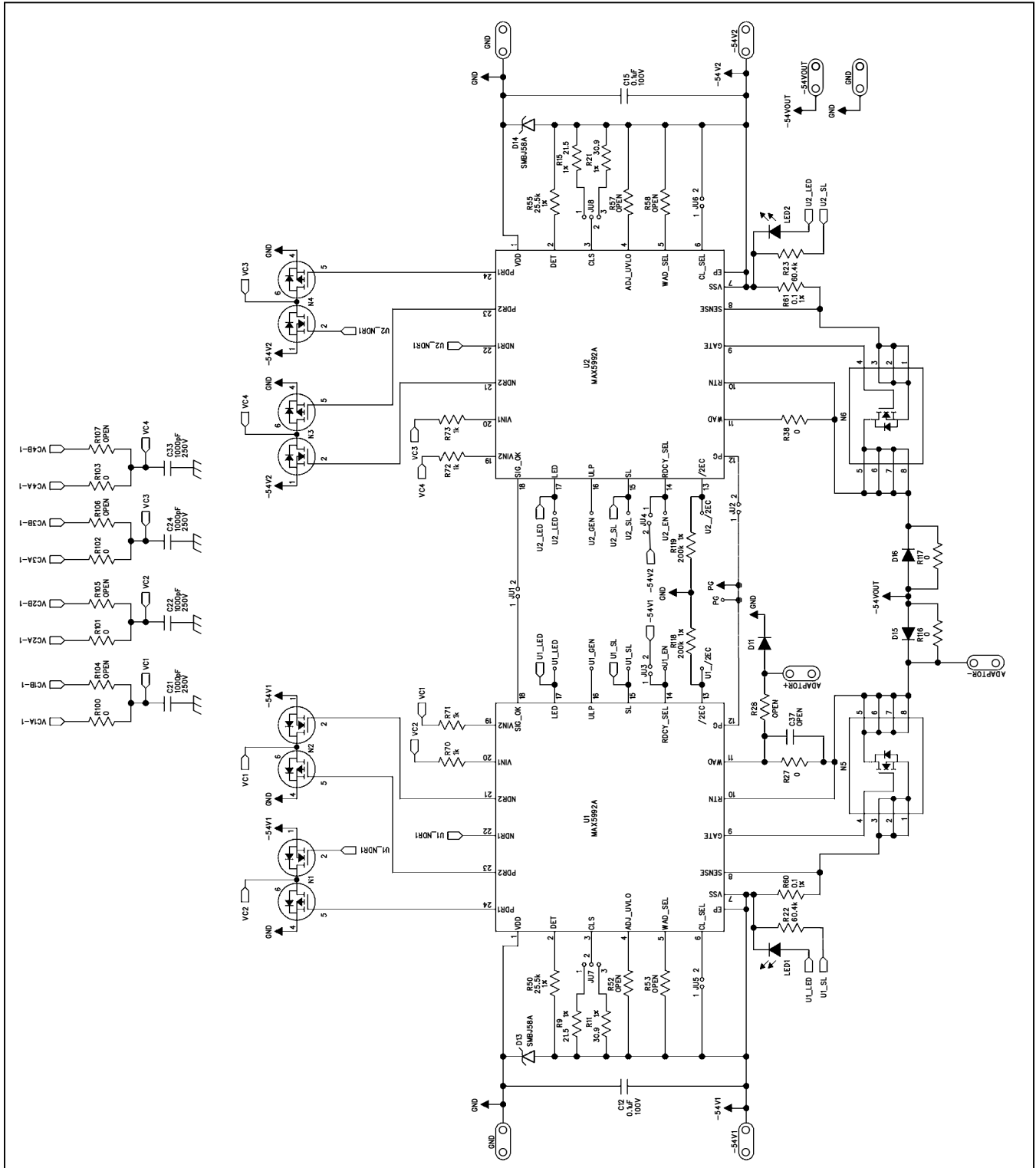

MAX5992A EV Kit Schematics (continued)

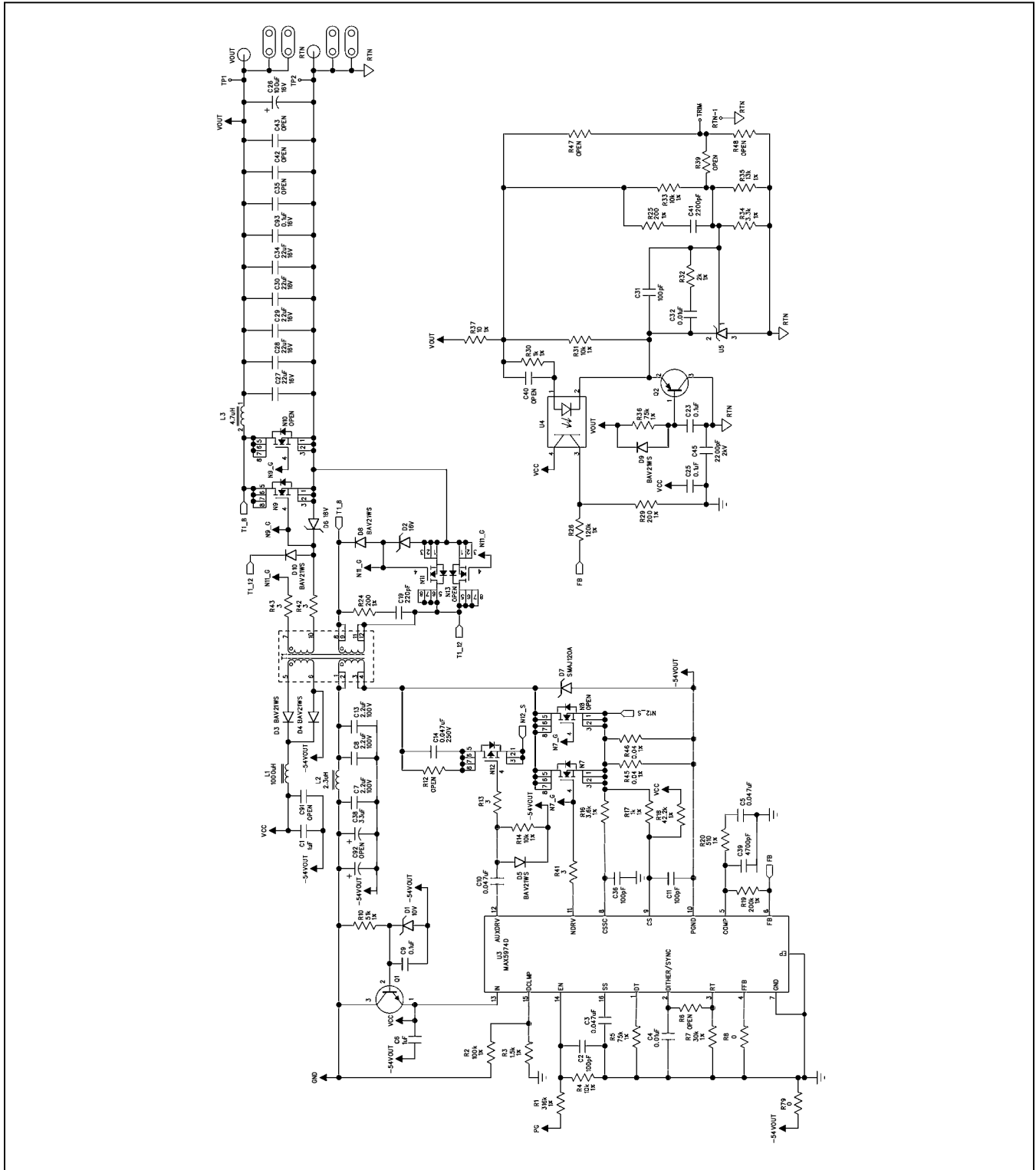

MAX5992A EV Kit PCB Layout Diagrams

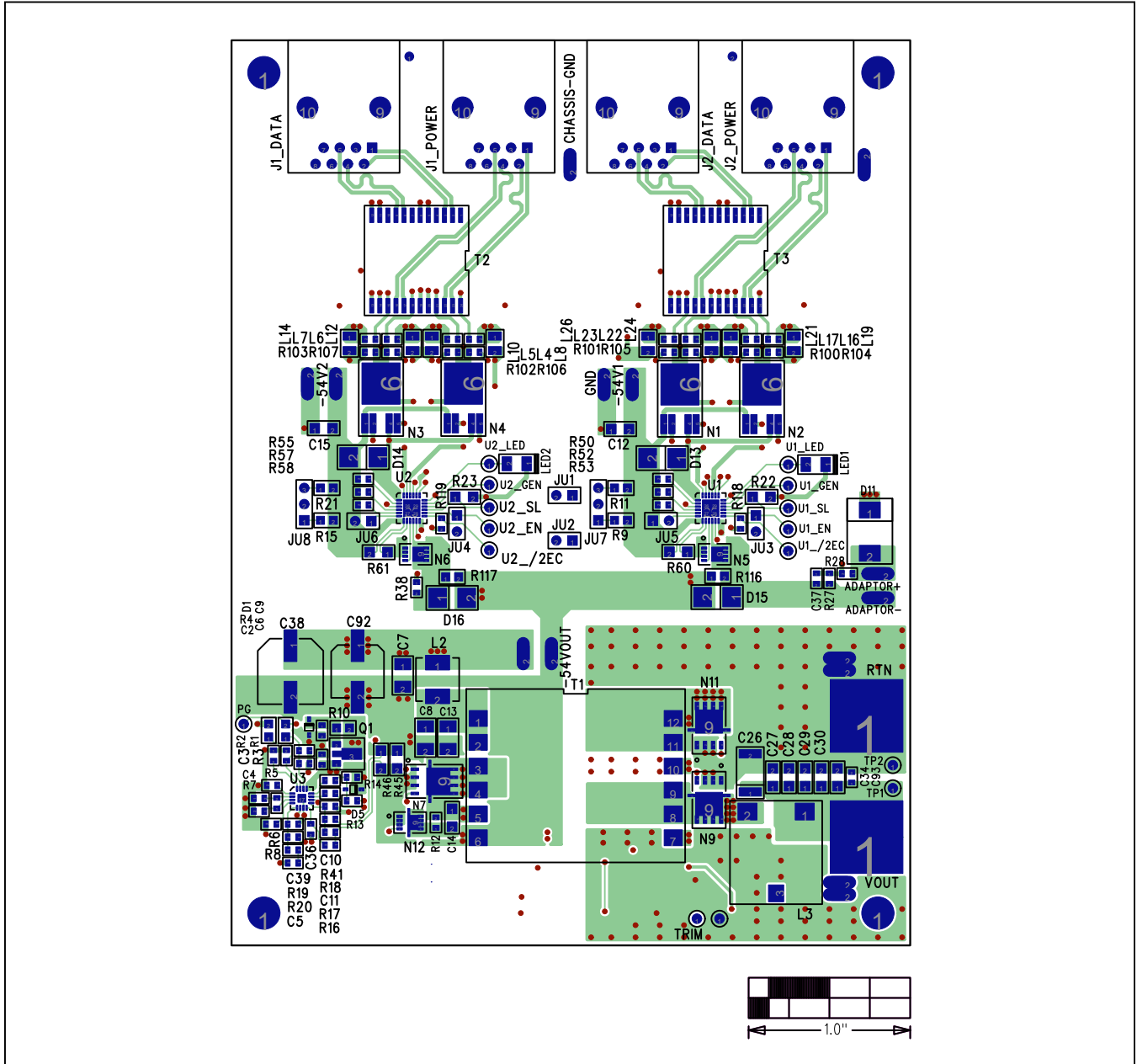

MAX5992 EV Kit—Top Layer

MAX5992A EV Kit PCB Layout Diagrams (continued)

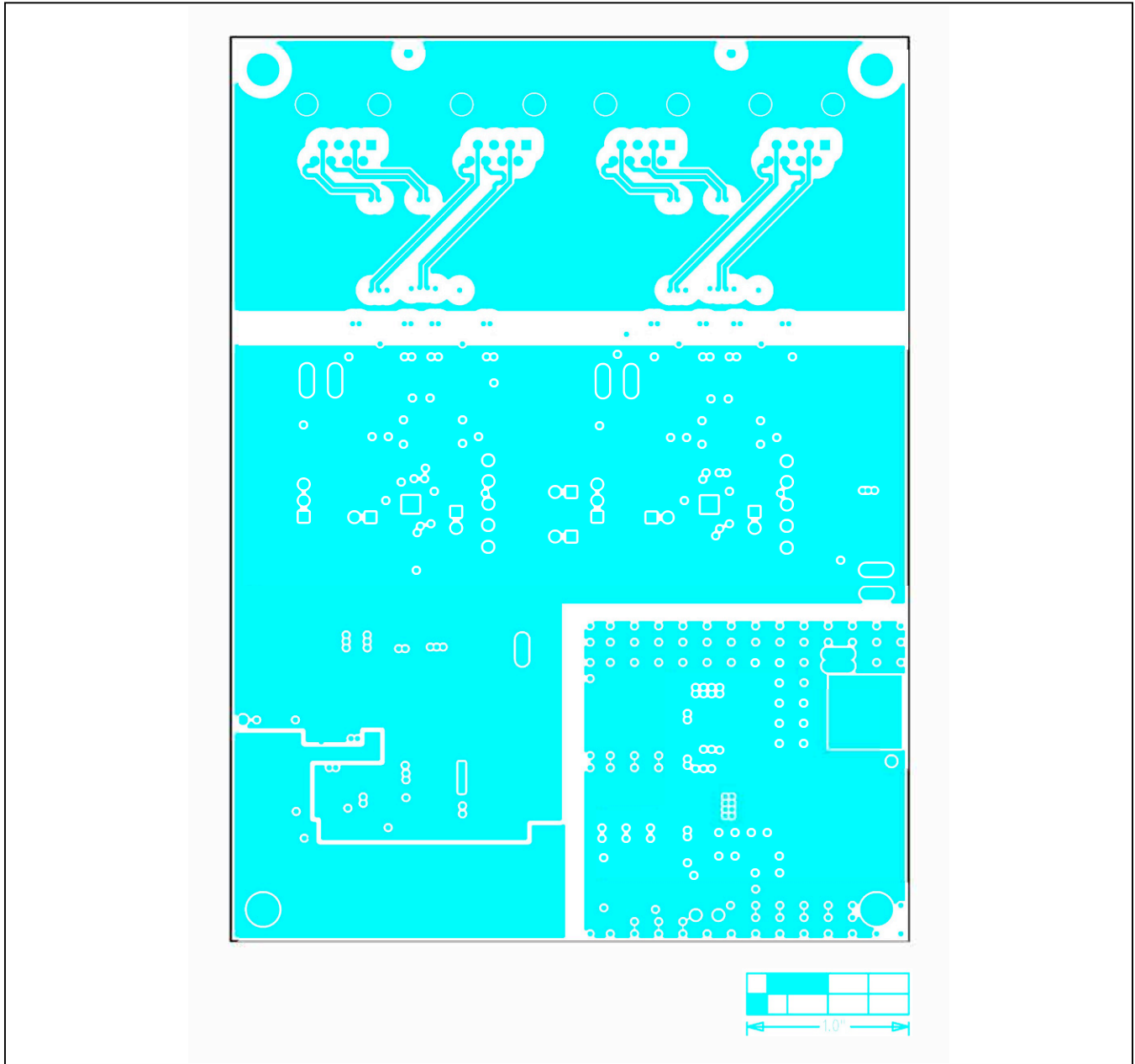

MAX5992 EV Kit—Layer 2 GND

MAX5992A EV Kit PCB Layout Diagrams (continued)

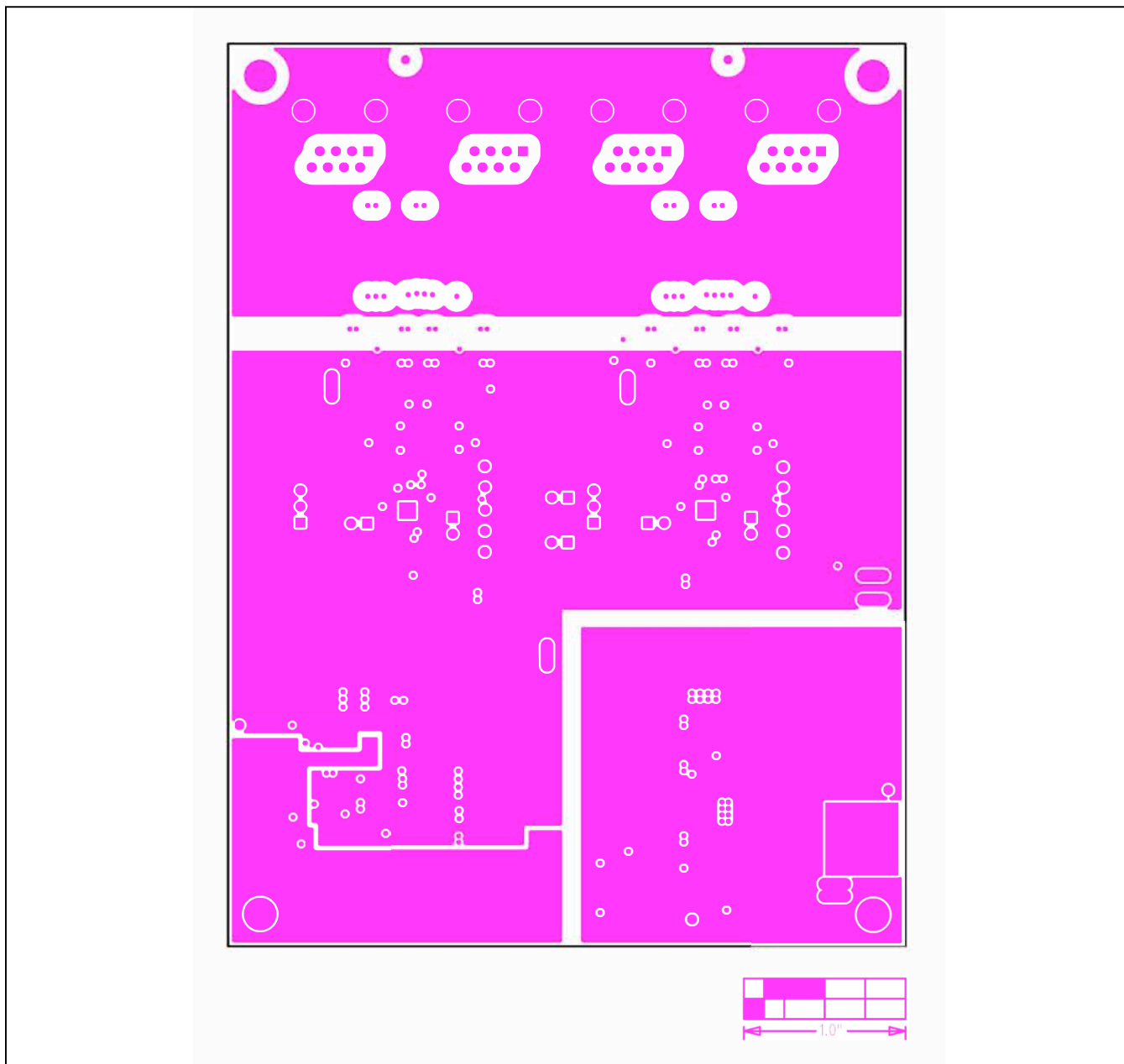

MAX5992 EV Kit—Layer 3 Power

MAX5992A EV Kit PCB Layout Diagrams (continued)

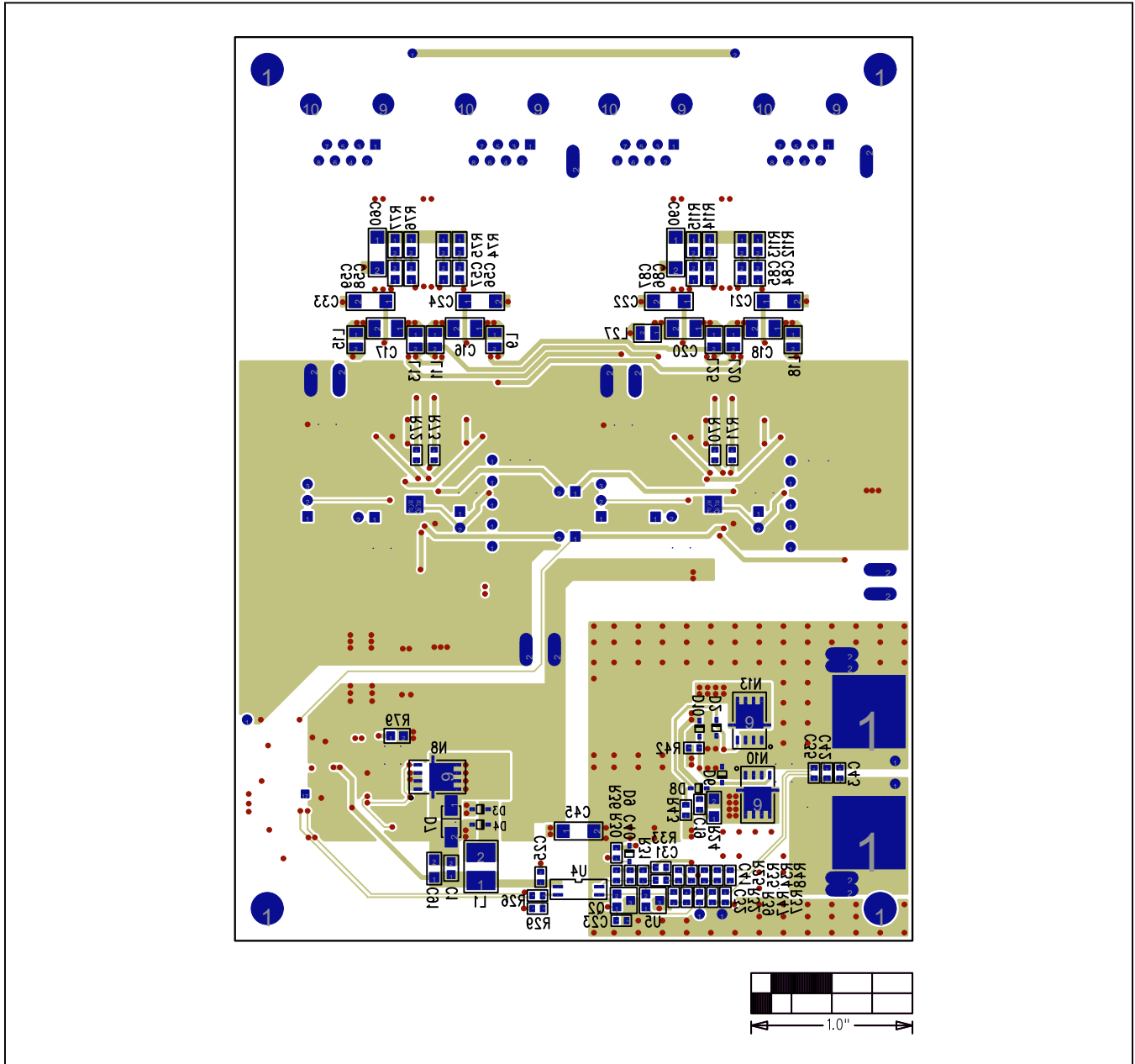

MAX5992 EV Kit—Bottom Layer

MAX5992A EV Kit PCB Layout Diagrams (continued)

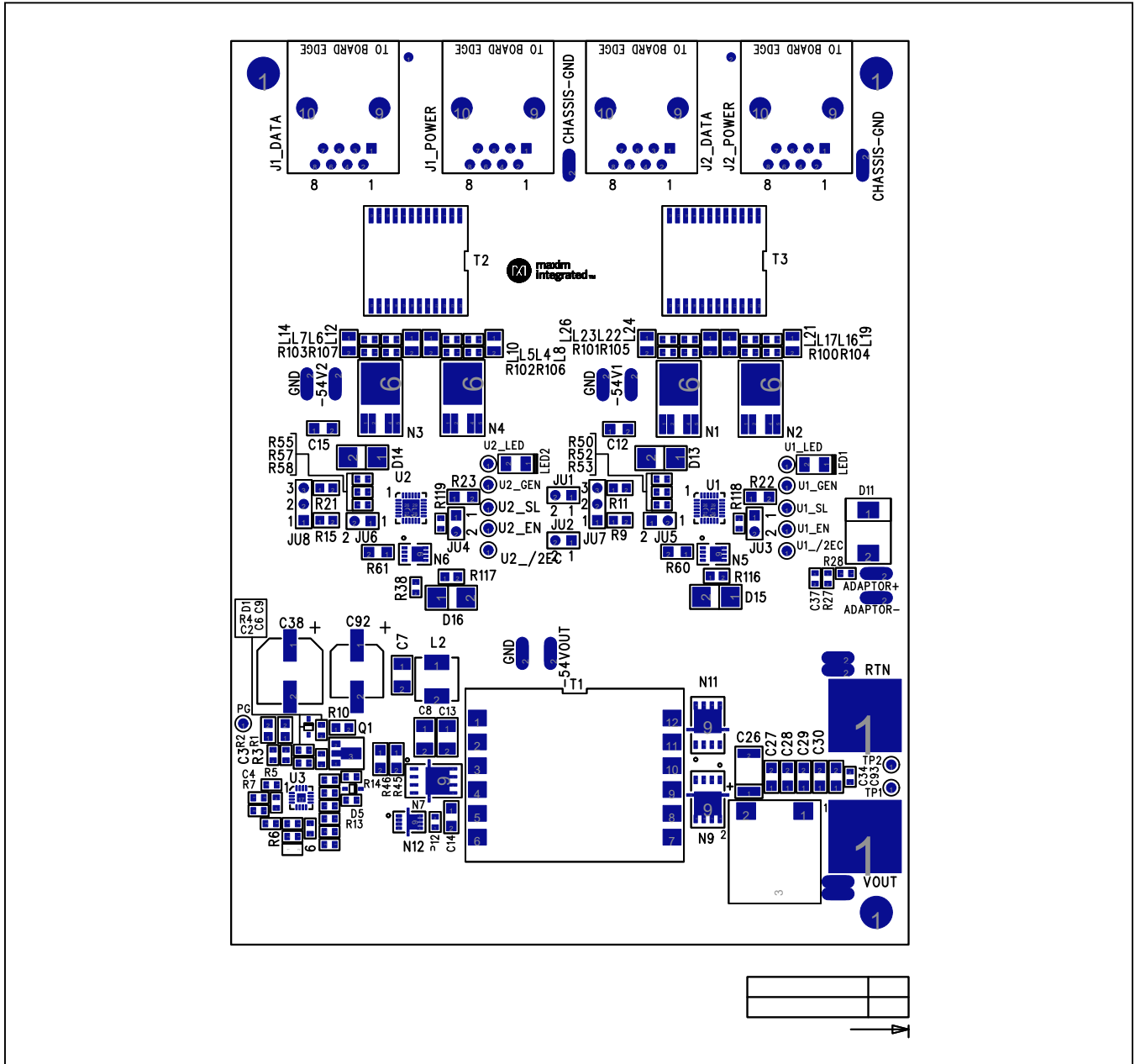

MAX5992 EV Kit—Top Silkscreen



MAX5992A EV Kit PCB Layout Diagrams (continued)

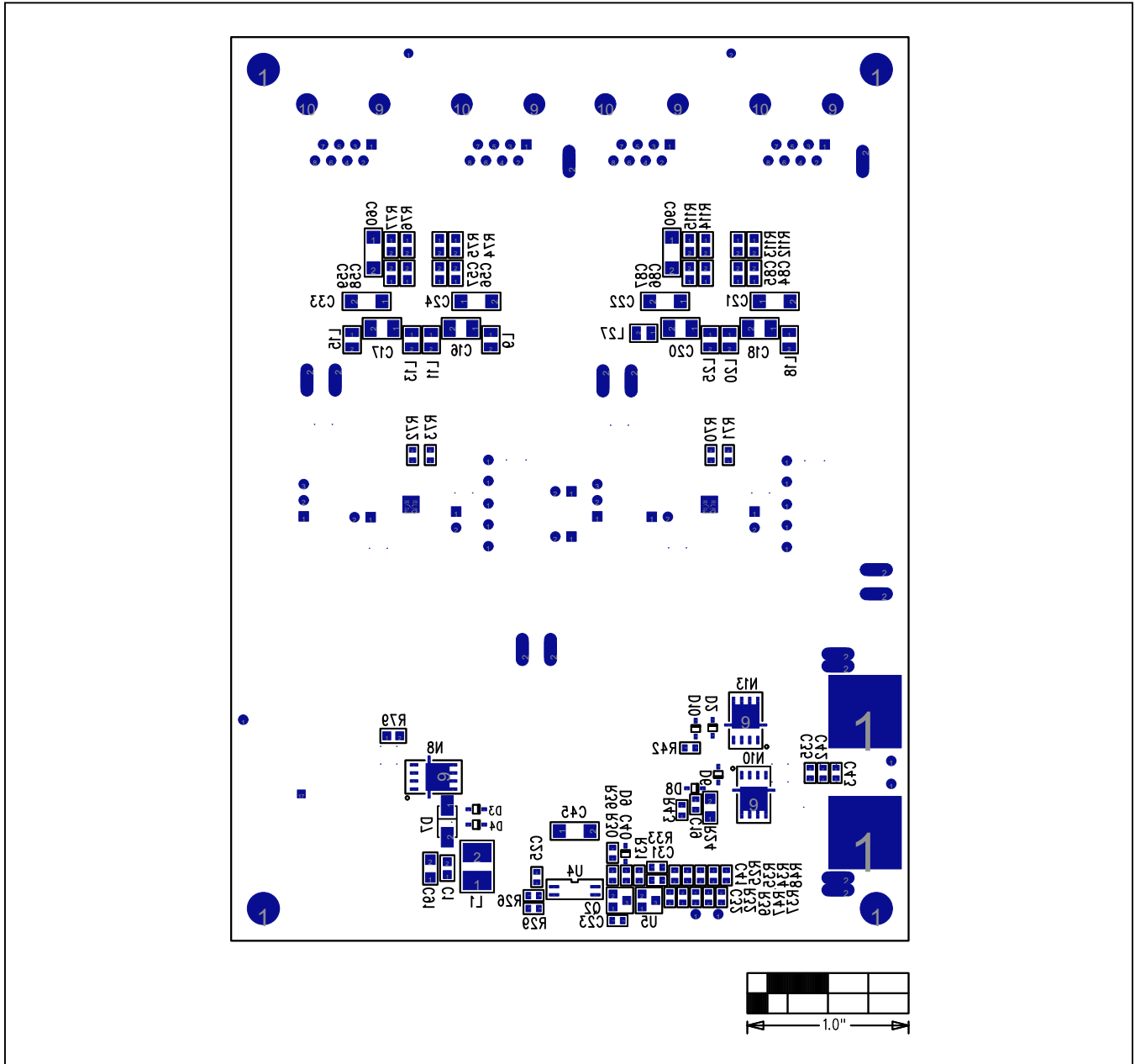

MAX5992 EV Kit—Bottom Silkscreen

## Revision History

REVISION NUMBER	REVISION DATE	DESCRIPTION	PAGES CHANGED
0	6/19	Initial release	—
1	6/19	Removed MAX5992B from title of EV kit	1–18

For pricing, delivery, and ordering information, please visit Maxim Integrated's online storefront at <https://www.maximintegrated.com/en/storefront/storefront.html>.

*Maxim Integrated cannot assume responsibility for use of any circuitry other than circuitry entirely embodied in a Maxim Integrated product. No circuit patent licenses are implied. Maxim Integrated reserves the right to change the circuitry and specifications without notice at any time.*

## X-ON Electronics

Largest Supplier of Electrical and Electronic Components

*Click to view similar products for [Power Management IC Development Tools](#) category:*

*Click to view products by [Maxim](#) manufacturer:*

Other Similar products are found below :

[EVB-EP5348UI](#) [MIC23451-AAAYFL EV](#) [MIC5281YMME EV](#) [124352-HMC860LP3E](#) [DA9063-EVAL](#) [ADP122-3.3-EVALZ](#) [ADP130-0.8-EVALZ](#) [ADP130-1.8-EVALZ](#) [ADP1740-1.5-EVALZ](#) [ADP1870-0.3-EVALZ](#) [ADP1874-0.3-EVALZ](#) [ADP199CB-EVALZ](#) [ADP2102-1.25-EVALZ](#) [ADP2102-1.875EVALZ](#) [ADP2102-1.8-EVALZ](#) [ADP2102-2-EVALZ](#) [ADP2102-3-EVALZ](#) [ADP2102-4-EVALZ](#) [AS3606-DB](#) [BQ25010EVM](#) [BQ3055EVM](#) [ISLUSBI2CKIT1Z](#) [LP38512TS-1.8EV](#) [EVAL-ADM1186-1MBZ](#) [EVAL-ADM1186-2MBZ](#) [ADP122UJZ-REDYKIT](#) [ADP166Z-REDYKIT](#) [ADP170-1.8-EVALZ](#) [ADP171-EVALZ](#) [ADP1853-EVALZ](#) [ADP1873-0.3-EVALZ](#) [ADP198CP-EVALZ](#) [ADP2102-1.0-EVALZ](#) [ADP2102-1-EVALZ](#) [ADP2107-1.8-EVALZ](#) [ADP5020CP-EVALZ](#) [CC-ACC-DBMX-51](#) [ATPL230A-EK](#) [MIC23250-S4YMT EV](#) [MIC26603YJL EV](#) [MIC33050-SYHL EV](#) [TPS60100EVM-131](#) [TPS65010EVM-230](#) [TPS71933-28EVM-213](#) [TPS72728YFFEVM-407](#) [TPS79318YEQEVM](#) [UCC28810EVM-002](#) [XILINXPWR-083](#) [LMR22007YMINI-EVM](#) [LP38501ATJ-EV](#)