

Click [here](#) for production status of specific part numbers.

MAX6033

High-Precision, Low-Dropout SOT23 Series Voltage Reference

General Description

The MAX6033 ultra-high-precision series voltage reference features a low 7ppm/°C (max) temperature coefficient and a low dropout voltage (200mV, max). Low temperature drift and low noise make the MAX6033 ideal for use with high-resolution ADCs or DACs.

- This device uses bandgap technology for low-noise performance and excellent accuracy. Laser-trimmed, high-stability, thin-film resistors, and post-package trimming guarantee excellent initial accuracy ($\pm 0.04\%$, max). The MAX6033 consumes only 40 μ A of supply current and sources up to 15mA. Series mode references save system power and use minimal external components compared to two-terminal shunt references.
- The MAX6033 is available in the miniature 6-pin SOT23 package and is offered over the automotive temperature range (-40°C to +125°C).

Applications

- Precision Regulators
- A/D and D/A Converters
- Power Supplies
- Hard-Disk Drives
- High-Accuracy Industrial and Process Control
- Hand-Held Instruments

Typical Operating Circuit appears at end of data sheet.

Benefits and Features

- Stable Performance Over Temperature and Time Improves Accuracy
 - Ultra-Low Temperature Drift: 7ppm/°C (max)
 - $\pm 0.04\%$ Initial Accuracy
 - Stable with Capacitive Loads up to 100 μ F
 - Low 16 μ V_{p-p} Noise (0.1Hz to 10Hz) (2.5V Output)
 - Low 200mV Dropout Voltage
 - Excellent Load Regulation: 0.001mV/mA
- Low 40 μ A Quiescent Current Reduces System Power Consumption
- 2.7V to 12.6V Supply Voltage Eases Power Requirements

Pin Configuration

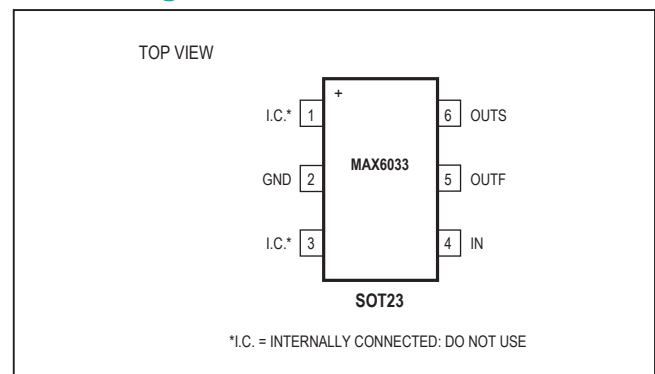

Ordering Information/Selector Guide

| PART | OUTPUT VOLTAGE (V) | TEMP COEFF (PPM/°C) | INITIAL ACCURACY (%) | TOP MARK |
|-----------------|--------------------|---------------------|----------------------|----------|
| MAX6033AAUT25-T | 2.500 | 10 | 0.04 | ABDF |
| MAX6033BAUT25+T | 2.500 | 15 | 0.20 | +AAXL |
| MAX6033BAUT25-T | 2.500 | 15 | 0.20 | AAXL |
| MAX6033CAUT25-T | 2.500 | 40 | 0.10 | AAXH |
| MAX6033CAUT25+T | 2.500 | 40 | 0.10 | +AAXH |

Ordering Information/Selector Guide continued on last page.

#Denotes a RoHS-compliant device that may include lead(Pb) that is exempt under the RoHS requirements.

T = Tape and reel.

*Denote as a future part.

Absolute Maximum Ratings

| | | | |
|--|-----------------|---|--------|
| IN to GND..... | -0.3V to +13V | Maximum Junction Temperature | +150°C |
| OUTF, OUTS to GND..... | -0.3V to +6V | Lead Temperature (soldering, 10s) | +300°C |
| Continuous Power Dissipation (TA = +70°C) | | Soldering Temperature (reflow) | |
| 6-Pin SOT23 (derate 7.40mW/°C above +70°C) ... | 595.20mW | RoHS-Compliant Packages | +245°C |
| Operating Temperature Range..... | -40°C to +125°C | Packages Containing Lead(Pb)..... | +240°C |
| Storage Temperature Range | -65°C to +150°C | | |

Stresses beyond those listed under "Absolute Maximum Ratings" may cause permanent damage to the device. These are stress ratings only, and functional operation of the device at these or any other conditions beyond those indicated in the operational sections of the specifications is not implied. Exposure to absolute maximum rating conditions for extended periods may affect device reliability.

Package Information

6 SOT23

| PACKAGE CODE | U6F+6 |
|---|-------------------------|
| Outline Number | 21-0058 |
| Land Pattern Number | 90-0175 |
| Thermal Resistance, Single-Layer Board | |
| Junction to Ambient (θ _{JA}) | 185.50 |
| Junction to Case (θ _{JC}) | 75 |
| Thermal Resistance, Four-Layer Board | |
| Junction to Ambient (θ _{JA}) | 134.40 |
| Junction to Case (θ _{JC}) | 39 |

RoHS SOT23-6

| PACKAGE CODE | U6FH+6 |
|---|--------|
| Outline Number | — |
| Land Pattern Number | — |
| Thermal Resistance, Single-Layer Board | |
| Junction to Ambient (θ _{JA}) | 185.50 |
| Junction to Case (θ _{JC}) | 75 |
| Thermal Resistance, Four-Layer Board | |
| Junction to Ambient (θ _{JA}) | 134.40 |
| Junction to Case (θ _{JC}) | 39 |

For the latest package outline information and land patterns (footprints), go to www.maximintegrated.com/packages. Note that a "+", "#", or "-" in the package code indicates RoHS status only. Package drawings may show a different suffix character, but the drawing pertains to the package regardless of RoHS status.

Package thermal resistances were obtained using the method described in JEDEC specification JESD51-7, using a four-layer board. For detailed information on package thermal considerations, refer to www.maximintegrated.com/thermal-tutorial.

Electrical Characteristics— $V_{OUT} = 2.500V$ $(V_{IN} = 5V, C_{OUT} = 0.1\mu F, I_{OUT} = 0A, T_A = T_{MIN}$ to T_{MAX} , unless otherwise specified. Typical values are at $T_A = +25^\circ C$.) (Note 1)

| PARAMETER | SYMBOL | CONDITIONS | | MIN | TYP | MAX | UNITS |
|--|---|---|--|---------------------------------------|--------|--------|-----------------|
| Output Voltage | V_{OUT} | $T_A = +25^\circ C$ | MAX6033A | 2.4990 | 2.5000 | 2.5010 | V |
| | | | MAX6033B | 2.4950 | 2.5000 | 2.5050 | |
| | | | MAX6033C | 2.4975 | 2.5000 | 2.5025 | |
| Output-Voltage Accuracy | | $T_A = +25^\circ C$ | MAX6033A | -0.04 | | +0.04 | % |
| | | | MAX6033B | -0.2 | | +0.2 | |
| | | | MAX6033C | -0.1 | | +0.1 | |
| Output Voltage Temperature Coefficient | TCV_{OUT} | MAX6033A | $T_A = -40^\circ C$ to $+85^\circ C$ | | 1.5 | 7 | ppm/ $^\circ C$ |
| | | | $T_A = -40^\circ C$ to $+125^\circ C$ | | 2.5 | 10 | |
| | | MAX6033B | $T_A = -40^\circ C$ to $+85^\circ C$ | | 3 | 10 | |
| | | | $T_A = -40^\circ C$ to $+125^\circ C$ | | 7 | 15 | |
| | | MAX6033C | $T_A = -40^\circ C$ to $+85^\circ C$ | | 6 | 20 | |
| | | | $T_A = -40^\circ C$ to $+125^\circ C$ | | 10 | 40 | |
| Input Voltage Range | V_{IN} | Inferred from line regulation specification | | 2.7 | | 12.6 | V |
| Line Regulation | $\frac{\Delta V_{OUT}}{\Delta V_{IN}}$ | $2.7V \leq V_{IN} \leq 12.6V$ | $T_A = +25^\circ C$ | | 3 | 25 | $\mu V/V$ |
| | | | $T_A = -40^\circ C$ to $+125^\circ C$ | | | 50 | |
| Load Regulation | $\frac{\Delta V_{OUT}}{\Delta I_{OUT}}$ | $-100\mu A \leq I_{OUT} \leq 15mA$ | $T_A = +25^\circ C$ | | 0.001 | 0.05 | mV/mA |
| | | | $T_A = -40^\circ C$ to $+125^\circ C$ | | | 0.1 | |
| Dropout Voltage (Note 2) | V_{DO} | $V_{OUT} = 0.1\%$, $I_{OUT} = 10mA$ | $V_{OUT} = 0.1\%$, $I_{OUT} = 1mA$ | | 0.02 | 0.2 | V |
| | | | $T_A = -40^\circ C$ to $+85^\circ C$ | | 0.3 | 0.4 | |
| | | | | $T_A = -40^\circ C$ to $+125^\circ C$ | | | |
| Quiescent Supply Current | I_{IN} | | $T_A = +25^\circ C$ | | 40 | 60 | μA |
| | | | $T_A = -40^\circ C$ to $+85^\circ C$ | | | 75 | |
| | | | $T_A = -40^\circ C$ to $+125^\circ C$ | | | 85 | |
| Output Short-Circuit Current | I_{SC} | | $V_{OUT} = 0V$ | | 90 | | mA |
| | | | $V_{OUT} = V_{IN}$ | | -2 | | |
| Output-Voltage Noise | en | | $0.1Hz \leq f \leq 10Hz$ | | 16 | | μV_{P-P} |
| | | | $10Hz \leq f \leq 1kHz$ | | 12 | | μV_{RMS} |
| Turn-On Settling Time | t_{ON} | | V_{OUT} settles to $\pm 0.01\%$ of final value | | 500 | | μs |
| Temperature Hysteresis | | | (Note 3) | | 150 | | ppm |
| Long-Term Stability | | | $\Delta t = 1000hr$ | | 40 | | ppm |

Electrical Characteristics— $V_{OUT} = 3.000V$ (V_{IN} = 5V, C_{OUT} = 0.1μF, I_{OUT} = 0A, T_A = T_{MIN} to T_{MAX}, unless otherwise specified. Typical values are at T_A = +25°C.) (Note 1)

| PARAMETER | SYMBOL | CONDITIONS | | MIN | TYP | MAX | UNITS |
|--|---|---|----------------------------------|--------|--------|--------|-------------------|
| Output Voltage | V _{OUT} | T _A = +25°C | MAX6033A | 2.9988 | 3.0000 | 3.0012 | V |
| | | | MAX6033B | 2.9940 | 3.0000 | 3.0060 | |
| | | | MAX6033C | 2.9970 | 3.0000 | 3.0030 | |
| Output-Voltage Accuracy | | T _A = +25°C | MAX6033A | -0.04 | | +0.04 | % |
| | | | MAX6033B | -0.2 | | +0.2 | |
| | | | MAX6033C | -0.1 | | +0.1 | |
| Output-Voltage Temperature Coefficient | TCV _{OUT} | MAX6033A | T _A = -40°C to +85°C | | 1.5 | 7 | ppm/°C |
| | | | T _A = -40°C to +125°C | | 2.5 | 10 | |
| | | MAX6033B | T _A = -40°C to +85°C | | 3 | 10 | |
| | | | T _A = -40°C to +125°C | | 7 | 15 | |
| | | MAX6033C | T _A = -40°C to +85°C | | 6 | 20 | |
| T _A = -40°C to +125°C | | 10 | 40 | | | | |
| Input Voltage Range | V _{IN} | Inferred from line regulation specification | | 3.2 | | 12.6 | V |
| Line Regulation | $\frac{\Delta V_{OUT}}{\Delta V_{IN}}$ | 3.2V ≤ V _{IN} ≤ 12.6V | T _A = +25°C | | 4 | 30 | μV/V |
| | | | T _A = -40°C to +125°C | | | 60 | |
| Load Regulation | $\frac{\Delta V_{OUT}}{\Delta I_{OUT}}$ | -100μA ≤ I _{OUT} ≤ 15mA | T _A = +25°C | | 0.002 | 0.06 | mV/mA |
| | | | T _A = -40°C to +125°C | | | 0.12 | |
| Dropout Voltage (Note 2) | V _{DO} | ΔV _{OUT} = 0.1% | I _{OUT} = 1mA | | 0.02 | 0.2 | V |
| | | | I _{OUT} = 10mA | | 0.2 | 0.4 | |
| Quiescent Supply Current | I _{IN} | T _A = +25°C | | | 40 | 60 | μA |
| | | T _A = -40°C to +85°C | | | | 75 | |
| | | T _A = -40°C to +125°C | | | | | |
| Output Short-Circuit Current | I _{SC} | V _{OUT} = 0V | | | 90 | | mA |
| | | V _{OUT} = V _{IN} | | | -2 | | |
| Output-Voltage Noise | en | 0.1Hz ≤ f ≤ 10Hz | | | 24 | | μV _{P-P} |
| | | 10Hz ≤ f ≤ 1kHz | | | 15 | | μV _{RMS} |
| Turn-On Settling Time | t _{ON} | V _{OUT} settles to ±0.01% of final value | | | 600 | | μs |
| Temperature Hysteresis | | (Note 3) | | | 150 | | ppm |
| Long-Term Stability | | Δt = 1000hr | | | 40 | | ppm |

Electrical Characteristics— $V_{OUT} = 4.096V$ $(V_{IN} = 5V, C_{OUT} = 0.1\mu F, I_{OUT} = 0A, T_A = T_{MIN}$ to T_{MAX} , unless otherwise specified. Typical values are at $T_A = +25^\circ C$.) (Note 1)

| PARAMETER | SYMBOL | CONDITIONS | | MIN | TYP | MAX | UNITS |
|--|---|--|---------------------------------------|--------|--------|--------|-----------------|
| Output Voltage | V_{OUT} | $T_A = +25^\circ C$ | MAX6033A | 4.0943 | 4.0960 | 4.0977 | V |
| | | | MAX6033B | 4.0878 | 4.0960 | 4.1042 | |
| | | | MAX6033C | 4.0919 | 4.0960 | 4.1001 | |
| Output-Voltage Accuracy | | $T_A = +25^\circ C$ | MAX6033A | -0.04 | | +0.04 | % |
| | | | MAX6033B | -0.2 | | +0.2 | |
| | | | MAX6033C | -0.1 | | +0.1 | |
| Output-Voltage Temperature Coefficient | TCV_{OUT} | MAX6033A | $T_A = -40^\circ C$ to $+85^\circ C$ | | 1.5 | 7 | ppm/ $^\circ C$ |
| | | | $T_A = -40^\circ C$ to $+125^\circ C$ | | 2.5 | 10 | |
| | | MAX6033B | $T_A = -40^\circ C$ to $+85^\circ C$ | | 3 | 10 | |
| | | | $T_A = -40^\circ C$ to $+125^\circ C$ | | 7 | 15 | |
| | | MAX6033C | $T_A = -40^\circ C$ to $+85^\circ C$ | | 6 | 20 | |
| | | | $T_A = -40^\circ C$ to $+125^\circ C$ | | 10 | 40 | |
| Input-Voltage Range | V_{IN} | Inferred from line regulation specification | | 4.3 | | 12.6 | V |
| Line Regulation | $\frac{\Delta V_{OUT}}{\Delta V_{IN}}$ | $4.3V \leq V_{IN} \leq 12.6V$ | $T_A = +25^\circ C$ | | 6 | 30 | $\mu V/V$ |
| | | | $T_A = -40^\circ C$ to $+125^\circ C$ | | | 60 | |
| Load Regulation | $\frac{\Delta V_{OUT}}{\Delta I_{OUT}}$ | $-100\mu A \leq I_{OUT} \leq 15mA$ | $T_A = +25^\circ C$ | | 0.002 | 0.08 | mV/mA |
| | | | $T_A = -40^\circ C$ to $+125^\circ C$ | | | 0.15 | |
| Dropout Voltage (Note 2) | V_{DO} | $\Delta V_{OUT} = 0.1\%$ | $I_{OUT} = 1mA$ | | 0.02 | 0.2 | V |
| | | | $I_{OUT} = 10mA$ | | 0.2 | 0.4 | |
| Quiescent Supply Current | I_{IN} | $T_A = +25^\circ C$ | | | 40 | 60 | μA |
| | | $T_A = -40^\circ C$ to $+85^\circ C$ | | | | 75 | |
| | | $T_A = -40^\circ C$ to $+125^\circ C$ | | | | | |
| Output Short-Circuit Current | I_{SC} | $V_{OUT} = 0V$ | | | 90 | | mA |
| | | $V_{OUT} = V_{IN}$ | | | -2 | | |
| Output-Voltage Noise | e_n | $0.1Hz \leq f \leq 10Hz$ | | | 32 | | μV_{P-P} |
| | | $10Hz \leq f \leq 1kHz$ | | | 22 | | μV_{RMS} |
| Turn-On Settling Time | t_{ON} | V_{OUT} settles to $\pm 0.01\%$ of final value | | | 800 | | μs |
| Temperature Hysteresis | | (Note 3) | | | 150 | | ppm |
| Long-Term Stability | | $\Delta t = 1000hr$ | | | 40 | | ppm |

Electrical Characteristics— $V_{OUT} = 5.000V$ (V_{IN} = 5.5V, C_{OUT} = 0.1μF, I_{OUT} = 0A, T_A = T_{MIN} to T_{MAX}, unless otherwise specified. Typical values are at T_A = +25°C.) (Note 1)

| PARAMETER | SYMBOL | CONDITIONS | | MIN | TYP | MAX | UNITS |
|--|---|---|----------------------------------|--------|-------|--------|-------------------|
| Output Voltage | V _{OUT} | T _A = +25°C | MAX6033A | 4.9980 | 5.000 | 5.0020 | V |
| | | | MAX6033B | 4.9900 | 5.000 | 5.0100 | |
| | | | MAX6033C | 4.9950 | 5.000 | 5.0050 | |
| Output-Voltage Accuracy | | T _A = +25°C | MAX6033A | -0.04 | | +0.04 | % |
| | | | MAX6033B | -0.2 | | +0.2 | |
| | | | MAX6033C | -0.1 | | +0.1 | |
| Output-Voltage Temperature Coefficient | TCV _{OUT} | MAX6033A | T _A = -40°C to +85°C | | 1.5 | 7 | ppm/°C |
| | | | T _A = -40°C to +125°C | | 2.5 | 10 | |
| | | MAX6033B | T _A = -40°C to +85°C | | 3 | 10 | |
| | | | T _A = -40°C to +125°C | | 7 | 15 | |
| | | MAX6033C | T _A = -40°C to +85°C | | 6 | 20 | |
| | | | T _A = -40°C to +125°C | | 10 | 40 | |
| Input Voltage Range | V _{IN} | Inferred from line regulation specification | | 5.2 | | 12.6 | V |
| Line Regulation | $\frac{\Delta V_{OUT}}{\Delta V_{IN}}$ | 5.2V ≤ V _{IN} ≤ 12.6V | T _A = +25°C | | 7 | 50 | μV/V |
| | | | T _A = -40°C to +125°C | | | 100 | |
| Load Regulation | $\frac{\Delta V_{OUT}}{\Delta I_{OUT}}$ | -100μA ≤ I _{OUT} ≤ 15mA | T _A = +25°C | | 0.003 | 0.1 | mV/mA |
| | | | T _A = -40°C to +125°C | | | 0.2 | |
| Dropout Voltage (Note 2) | V _{DO} | ΔV _{OUT} = 0.1% | I _{OUT} = 1mA | | 0.02 | 0.2 | V |
| | | | I _{OUT} = 10mA | | 0.2 | 0.4 | |
| Quiescent Supply Current | I _{IN} | T _A = +25°C | | | 40 | 60 | μA |
| | | T _A = -40°C to +85°C | | | | 75 | |
| | | T _A = -40°C to +125°C | | | | | |
| Output Short-Circuit Current | I _{SC} | V _{OUT} = 0V | | | 90 | | mA |
| | | V _{OUT} = V _{IN} | | | -2 | | |
| Output-Voltage Noise | en | 0.1Hz ≤ f ≤ 10Hz | | | 40 | | μV _{P-P} |
| | | 10Hz ≤ f ≤ 1kHz | | | 26 | | μV _{RMS} |
| Turn-On Settling Time | t _{ON} | V _{OUT} settles to ±0.01% of final value | | | 1000 | | μs |
| Temperature Hysteresis | | (Note 3) | | | 150 | | ppm |
| Long-Term Stability | | Δt = 1000hr | | | 40 | | ppm |

Note 1: MAX6033 is 100% production tested at T_A = +25°C and is guaranteed by design for T_A = T_{MIN} to T_{MAX} as specified.Note 2: Dropout Voltage is the minimum input voltage at which V_{OUT} changes ≤ 0.1% from V_{OUT} at V_{IN} = 5V (V_{IN} = 5.5V to V_{OUT} = 5V).Note 3: Temperature Hysteresis is defined as the change in +25°C output voltage before and after cycling the device from T_{MAX} to T_{MIN}.

Typical Operating Characteristics

($V_{IN} = 5V$, $C_{OUT} = 0.1\mu F$, $I_{OUT} = 0A$, $T_A = +25^\circ C$, unless otherwise specified.) (Note 4)

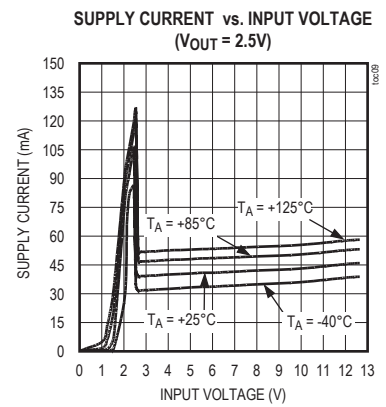
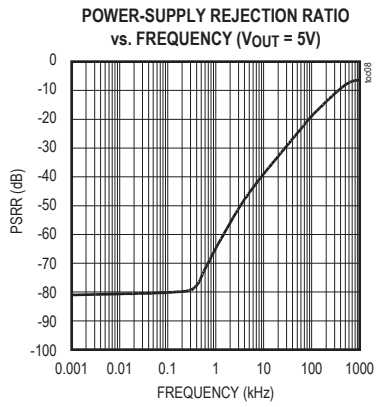
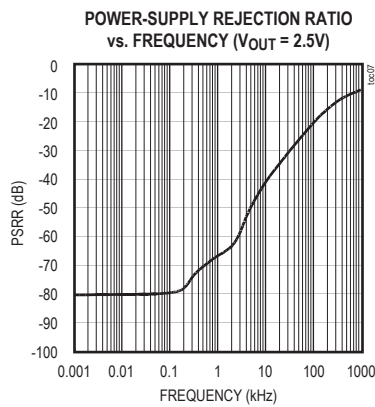
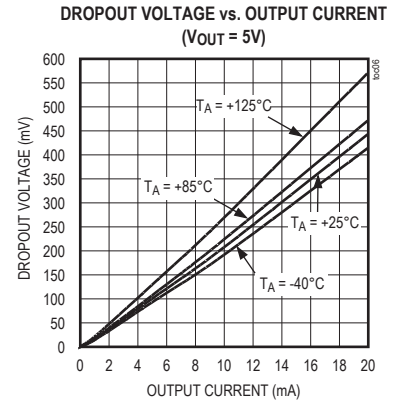
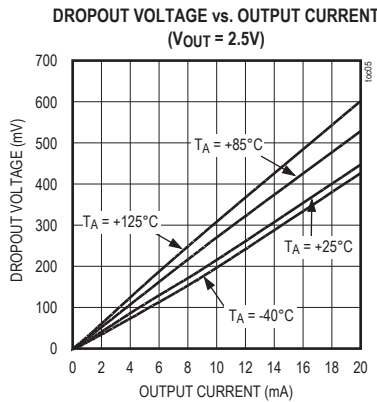
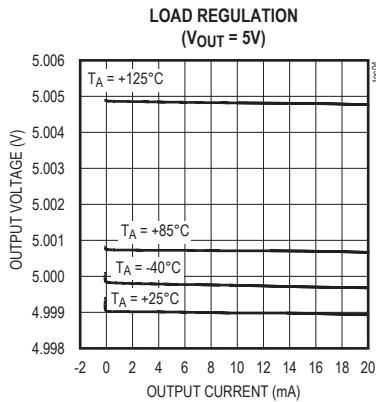
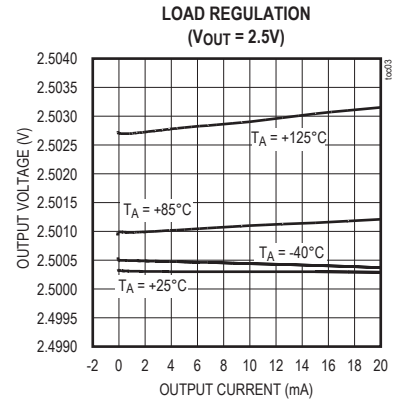
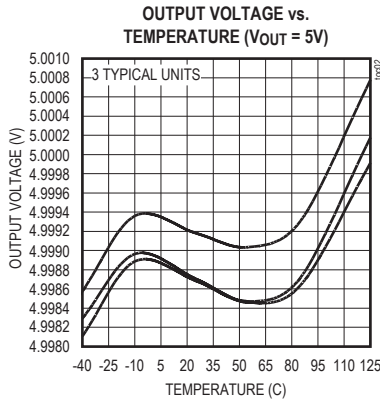
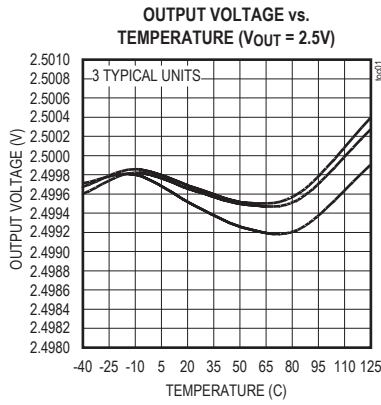

Typical Operating Characteristics (continued)

($V_{IN} = 5V$, $C_{OUT} = 0.1\mu F$, $I_{OUT} = 0A$, $T_A = +25^\circ C$, unless otherwise specified.) (Note 4)

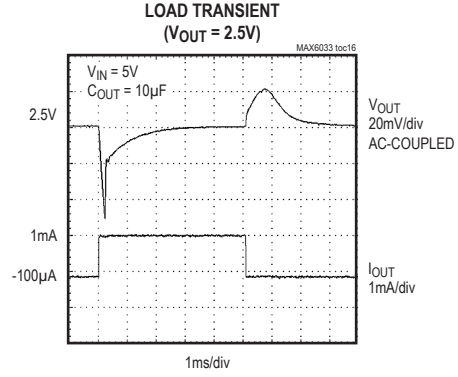
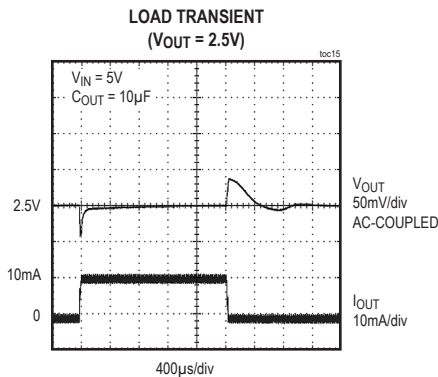
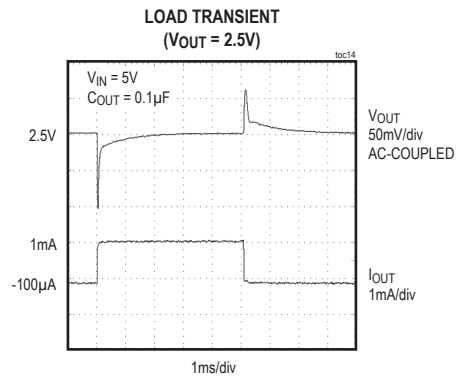
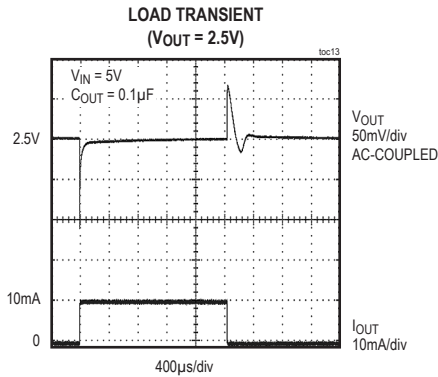
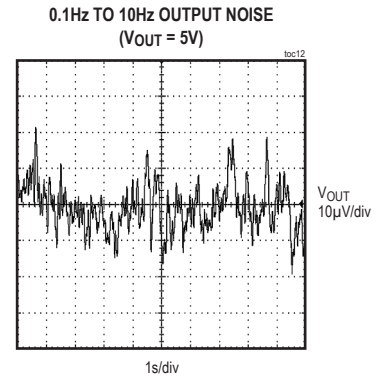
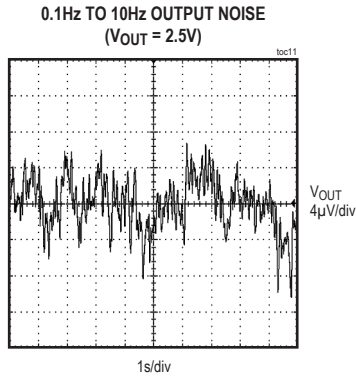
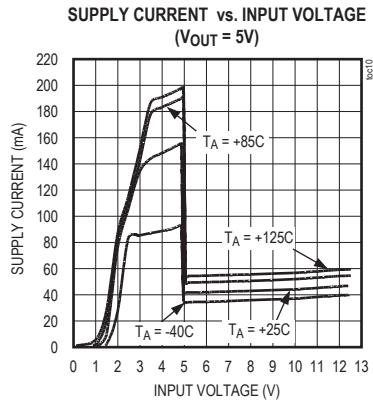

Typical Operating Characteristics (continued)

($V_{IN} = 5V$, $C_{OUT} = 0.1\mu F$, $I_{OUT} = 0A$, $T_A = +25^\circ C$, unless otherwise specified.) (Note 4)

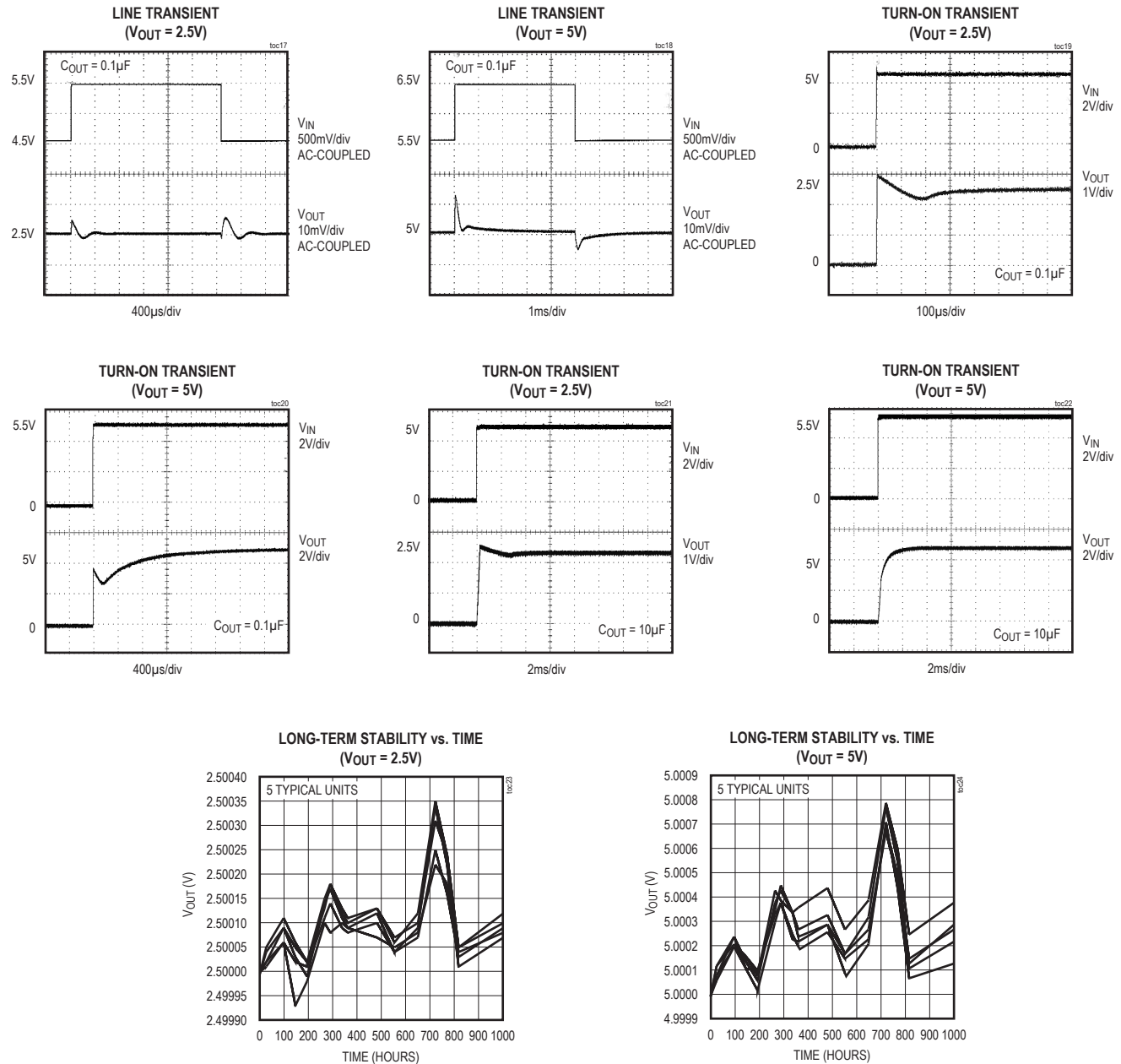

Note 4: Many of the MAX6033 Typical Operating Characteristics are similar. The extremes of these characteristics are found in the MAX6033 (2.5V output) and the MAX6033 (5V output). The Typical Operating Characteristics of the remainder of the MAX6033 family typically lie between these two extremes and can be estimated based on their output voltages.

Pin Description

| PIN | NAME | FUNCTION |
|------|------|---|
| 1, 3 | I.C. | Internally Connected. Do not connect externally. |
| 2 | GND | Ground |
| 4 | IN | Positive Power-Supply Input |
| 5 | OUTF | Voltage Reference Force Output. Short OUTF to OUTS as close to the device as possible. Bypass OUTF with 0.1µF (min) capacitor to GND. |
| 6 | OUTS | Voltage Reference Sense |

Applications Information

Bypassing/Load Capacitance

For the best line-transient performance, decouple the input with a 0.1µF ceramic capacitor as shown in the Typical Operating Circuit. Place the capacitor as close to IN as possible. When transient performance is less important, no capacitor is necessary.

The MAX6033 family requires a minimum output capacitance of 0.1µF for stability and is stable with capacitive loads (including the bypass capacitance) of up to 100µF. In applications where the load or the supply can experience step changes, a larger output capacitor reduces the amount of overshoot (undershoot) and improves the circuit's transient response. Place output capacitors as close to the device as possible.

Supply Current

The quiescent supply current of the MAX6033 series reference is typically 40µA and is virtually independent of the supply voltage. In the MAX6033 family, the load current is drawn from the input only when required, so supply current is not wasted and efficiency is maximized at all input voltages. This improved efficiency reduces power dissipation and extends battery life.

When the supply voltage is below the minimum-specified input voltage (as during turn-on), the devices can draw up to 150µA beyond the nominal supply current. The input voltage source must be capable of providing this current to ensure reliable turn-on.

Output-Voltage Hysteresis

Output voltage hysteresis is the change in the output voltage at $T_A = +25^\circ\text{C}$ before and after the device is cycled over its entire operating temperature range. Hysteresis is caused by differential package stress appearing across

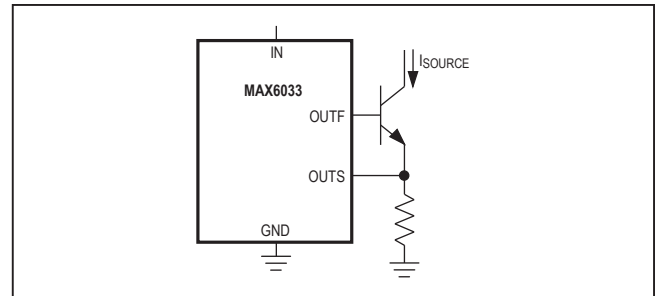

Figure 1. Precision Current Source

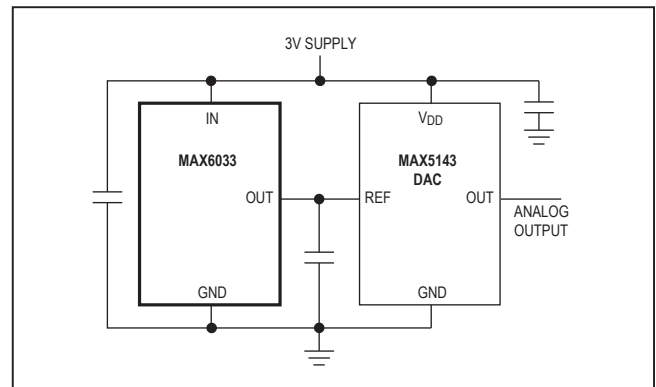

Figure 2. 14-Bit High-Resolution DAC and Positive Reference from a Single 3V Supply

the bandgap core transistors. The typical temperature hysteresis value is 150ppm.

Turn-On Time

These devices typically turn on and settle to within 0.01% of their final value in $>1\mu\text{s}$. The turn-on time can increase up to 2ms with the device operating at the minimum drop-out voltage and the maximum load.

Precision Current Source

Figure 1 shows a typical circuit providing a precision current source. The OUTF output provides the bias current for the bipolar transistor. OUTS senses the voltage across the resistor and adjusts the current sourced by OUTF accordingly.

High-Resolution DAC and Reference from Single Supply

Figure 2 shows a typical circuit providing both the power supply and reference for a high-resolution DAC. A MAX6033 with 2.5V output provides the reference voltage for the DAC.

Ordering Information/Selector Guide (continued)

| PART | OUTPUT VOLTAGE (V) | TEMP COEFF (PPM/°C) | INITIAL ACCURACY (%) | TOP MARK |
|-----------------|--------------------|---------------------|----------------------|----------|
| MAX6033AAUT30-T | 3.000 | 10 | 0.04 | ABDG |
| MAX6033BAUT30+T | 3.000 | 15 | 0.20 | +AAXM |
| MAX6033BAUT30-T | 3.000 | 15 | 0.20 | AAXM |
| MAX6033BAUT30+T | 3.000 | 15 | 0.20 | +AAXM |
| MAX6033CAUT30-T | 3.000 | 40 | 0.10 | AAXI |
| MAX6033CAUT30+T | 3.000 | 40 | 0.10 | +AAXI |
| MAX6033AAUT41-T | 4.096 | 10 | 0.04 | ABDH |
| MAX6033BAUT41+T | 4.096 | 15 | 0.20 | +AAXN |
| MAX6033BAUT41-T | 4.096 | 15 | 0.20 | AAXN |
| MAX6033CAUT41-T | 4.096 | 40 | 0.10 | AAXJ |
| MAX6033CAUT41+T | 4.096 | 40 | 0.10 | +AAXJ |
| MAX6033AAUT50-T | 5.000 | 10 | 0.04 | ABDI |
| MAX6033BAUT50+T | 5.000 | 15 | 0.20 | +AAXO |
| MAX6033BAUT50-T | 5.000 | 15 | 0.20 | AAXO |
| MAX6033CAUT50-T | 5.000 | 40 | 0.10 | AAXK |
| MAX6033CAUT50+T | 5.000 | 40 | 0.10 | +AAXK |

#Denotes a RoHS-compliant device that may include lead(Pb) that is exempt under the RoHS requirements.

T = Tape and reel.

Typical Operating Circuit

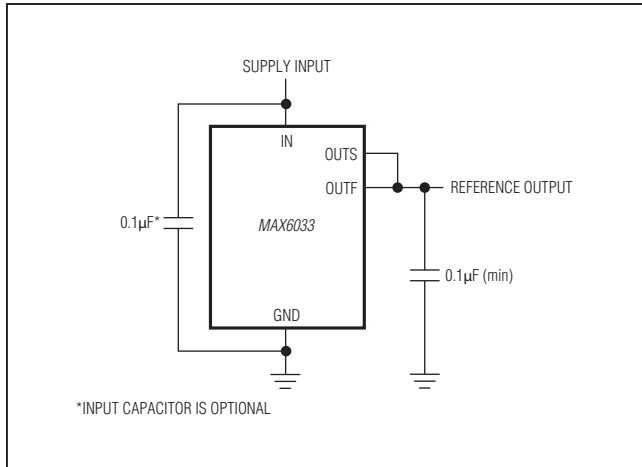

Chip Information

PROCESS: BiCMOS

Revision History

| REVISION NUMBER | REVISION DATE | DESCRIPTION | PAGES CHANGED |
|-----------------|---------------|--|---------------|
| 2 | 6/03 | Various changes | — |
| 3 | 3/12 | Replaced <i>Ordering Information</i> table/Selector Guide, updated packaging information | 1, 10 |
| 4 | 2/19 | Updated <i>Ordering Information</i> , <i>Absolute Maximum Ratings</i> , and <i>Package Thermal Characteristics</i> | 1, 2, 10 |
| 5 | 3/19 | Updated <i>Ordering Information</i> | 1, 11 |
| 6 | 8/19 | Updated <i>Ordering Information</i> | 11 |
| 7 | 1/20 | Updated <i>Ordering Information</i> | 1 |
| 8 | 8/21 | Updated <i>Ordering Information</i> | 1, 11 |

For pricing, delivery, and ordering information, please visit Maxim Integrated's online storefront at <https://www.maximintegrated.com/en/storefront/storefront.html>.

Maxim Integrated cannot assume responsibility for use of any circuitry other than circuitry entirely embodied in a Maxim Integrated product. No circuit patent licenses are implied. Maxim Integrated reserves the right to change the circuitry and specifications without notice at any time. The parametric values (min and max limits) shown in the Electrical Characteristics table are guaranteed. Other parametric values quoted in this data sheet are provided for guidance.

X-ON Electronics

Largest Supplier of Electrical and Electronic Components

Click to view similar products for [Voltage References](#) category:

Click to view products by [Maxim](#) manufacturer:

Other Similar products are found below :

[REF01J/883](#) [5962-8686103XC](#) [NCV431BVDMR2G](#) [LT6654AMPS6-2.048#TRMPBF](#) [SCV431AIDMR2G](#) [LT1019AIS8-2.5](#)
[LT6654AMPS6-3.3#TRM](#) [SC431ILPRAG](#) [AP432AQG-7](#) [LM4040B25QFTA](#) [NJM2823F-TE1](#) [TL431-A](#) [MCP1502T-18E/CHY](#) [MCP1502T-40E/CHY](#) [TL4050B25QDBZR](#) [TL431ACZ](#) [KA431SLMF2TF](#) [KA431SMF2TF](#) [KA431SMFTF](#) [LM4041C12ILPR](#) [LM4120AIM5-2.5/NOP](#)
[LM431SCCMFX](#) [TS3330AQPR](#) [REF5040MDREP](#) [LM285BXM-1.2/NOPB](#) [LM385BM-2.5/NOPB](#) [LM4040AIM3-10.0](#) [LM4040BIM3-4.1](#)
[LM4040CIM3-10.0](#) [LM4040CIM3X-2.0/NOPB](#) [LM4041BSD-122GT3](#) [LM4041QDIM3-ADJ/NO](#) [LM4050QAEM3X4.1/NOPB](#)
[LM4051BIM3-ADJ/NOPB](#) [LM4051CIM3X-1.2/NOPB](#) [LM4128CMF-1.8/NOPB](#) [LM4132DMF-1.8/NOPB](#) [LM4132EMF-1.8/NOPB](#)
[LM4132EMF-2.0/NOPB](#) [LM4140CCMX-1.2/NOPB](#) [LM431CIM](#) [LM385M-2.5/NOPB](#) [LM4030AMF-4.096/NOPB](#) [LM4040D30ILPR](#)
[LM4051CIM3X-ADJ/NOPB](#) [AP432YG-13](#) [AS431ANTR-G1](#) [AS431BZTR-E1](#) [AN431AN-ATRG1](#) [AP431IBNTR-G1](#)