



[Evaluation Kit Available](#)



[Design Resources](#)



[Tools and Models](#)



[Support](#)

Click [here](#) to ask an associate for production status of specific part numbers.

±1°C Accurate 8-Channel Temperature Sensor

MAX6581

General Description

The MAX6581 precision multichannel temperature sensor monitors its own temperature and the temperatures of up to seven external diode-connected transistors. All temperature channels have programmable alert and over-temperature thresholds. When the measured temperature of a channel crosses the respective threshold, a status bit is set in one of the status registers. Two open-drain alarm outputs ($\overline{\text{ALERT}}$ and $\overline{\text{OVERT}}$) assert corresponding to these bits in the status register(s).

Resistance cancellation is available for all channels and compensates for high series resistance in circuit-board traces and thermal diodes.

The 2-wire serial interface accepts SMBus protocols (write byte, read byte, send byte, and receive byte) for reading the temperature data and programming the alarm thresholds.

The MAX6581 is specified for an operating temperature range of -40°C to +125°C and is available in a 24-pin, 4mm x 4mm thin QFN package with an exposed pad.

Features

- Eight Channels to Measure Seven Remote and One Local Temperature
- 11-Bit, 0.125°C Resolution
- High Accuracy of ±1°C (max) from +60°C to +100°C (Remote Channels)
- -64°C to +150°C Remote Temperature Range
- Programmable Undertemperature/Overtemperature Alerts
- SMBus/I²C-Compatible Interface
- Two Open-Drain Alarm Outputs ($\overline{\text{ALERT}}$ and $\overline{\text{OVERT}}$)
- Resistance Cancellation on All Remote Channels

Applications

- Desktop Computers
- Notebook Computers
- Workstations
- Servers
- Data Communications

Ordering Information/Selector Guide

PART	SLAVE ADDRESS	PIN-PACKAGE	OPERATING TEMPERATURE RANGE	MEASURED TEMPERATURE RANGE
MAX6581TG9A+	0X9A	24 TQFN-EP*	-40°C to +125°C	-64°C to +150°C
MAX6581TG9C+	0X9C	24 TQFN-EP*	-40°C to +125°C	-64°C to +150°C
MAX6581TG9E+	0X9E	24 TQFN-EP*	-40°C to +125°C	-64°C to +150°C
MAX6581TG98+	0X98	24 TQFN-EP*	-40°C to +125°C	-64°C to +150°C

Note: All devices are specified over the -40°C to +125°C operating temperature range.

+Denotes a lead(Pb)-free/RoHS-compliant package.

*EP = Exposed pad.

Typical Application Circuit appears at end of data sheet.

Absolute Maximum Ratings

(All voltages referenced to GND.)

V _{CC} , SMBCLK, SMBDATA, ALERT, OVERT, STBY to GND.....	-0.3V to +4V
DXP_ to GND.....	-0.3V to (V _{CC} + 0.3V)
DXN_ to GND.....	-0.3V to (V _{CC} + 0.3V)
SMBDATA, ALERT, OVERT Current.....	-1mA to +50mA
DXN_ Current.....	±1mA

Continuous Power Dissipation (T _A = +70°C)	
TQFN (derate 27.8mW/°C above +70°C).....	2222mW
ESD Protection (All Pins, Human Body Model)	±2kV
Operating Temperature Range.....	-40°C to +125°C
Junction Temperature.....	+150°C
Storage Temperature Range	-65°C to +150°C
Lead Temperature (soldering, 10s)	+300°C
Soldering Temperature (reflow).....	+260°C

Stresses beyond those listed under "Absolute Maximum Ratings" may cause permanent damage to the device. These are stress ratings only, and functional operation of the device at these or any other conditions beyond those indicated in the operational sections of the specifications is not implied. Exposure to absolute maximum rating conditions for extended periods may affect device reliability.

Package Thermal Characteristics (Note 1)

TQFN

Junction-to-Ambient Thermal Resistance (θ _{JA})	36.0°C/W
Junction-to-Case Thermal Resistance (θ _{JC}).....	3.0°C/W

Note 1: Package thermal resistances were obtained using the method described in JEDEC specification JESD51-7, using a four-layer board. For detailed information on package thermal considerations, refer to www.maximintegrated.com/thermal-tutorial.

Electrical Characteristics

(V_{CC} = +3.0V to +3.6V, T_A = -40°C to +125°C, unless otherwise noted. Typical values are at V_{CC} = +3.3V and T_A = +25°C.) (Note 2)

PARAMETER	SYMBOL	CONDITIONS	MIN	TYP	MAX	UNITS
Supply Voltage	V _{CC}		3.0		3.6	V
Standby Supply Current	I _{SS}	SMBus static		4	15	µA
Operating Current	I _{CC1}	During conversion, RC off		500	600	µA
	I _{CC2}	During conversion, RC on		550	650	
Temperature Resolution				11		Bits
				0.125		°C
3-Sigma Temperature Accuracy (Remote Channels 1–7)	V _{CC} = 3.3V	T _A = +30°C to +85°C, T _{RJ} = +60°C to +100°C	-0.85		+0.85	°C
		T _A , T _{RJ} = -40°C to +125°C	-1.2		+1.2	
		T _A = +30°C to +85°C, T _{RJ} = +100°C to +150°C	-2.5		+2.5	
3-Sigma Temperature Accuracy (Local)	V _{CC} = 3.3V	T _A = +30°C to +85°C	-1		+1	°C
		T _A = -40°C to +125°C	-2		+2	
		T _A = 0°C to +150°C	-3		+3	
6-Sigma Temperature Accuracy (Remote Channels 1–7)	V _{CC} = 3.3V	T _A = +30°C to +85°C, T _{RJ} = +60°C to +100°C	-1		+1	°C
		T _A , T _{RJ} = -40°C to +125°C	-2		+2	
		T _A = +30°C to +85°C, T _{RJ} = +100°C to +125°C	-2.75		+2.75	
6-Sigma Temperature Accuracy (Local)	V _{CC} = 3.3V	T _A = +30°C to +85°C	-1.5		+1.5	°C
		T _A = -40°C to +125°C	-2.5		+2.5	
		T _A = 0°C to +150°C	-3.5		+3.5	

Electrical Characteristics (continued)(V_{CC} = +3.0V to +3.6V, T_A = -40°C to +125°C, unless otherwise noted. Typical values are at V_{CC} = +3.3V and T_A = +25°C.) (Note 2)

PARAMETER	SYMBOL	CONDITIONS	MIN	TYP	MAX	UNITS	
Supply Sensitivity of Temperature Accuracy				±0.2		°C/V	
Conversion Time per Channel	t _{CONV}	Resistance cancellation mode off	95	125	156	ms	
		Resistance cancellation mode on or beta compensation on	190	250	312		
Remote-Diode Source Current	I _{RJ}	High level	Resistance cancellation mode off	80	100	120	μA
		Low level		8	10	12	
		High level	Resistance cancellation mode on or beta compensation on	160	200	240	
		Low level		16	20	24	
DXP_ and DXN_ Leakage Current		Standby mode			100	nA	
Undervoltage Lockout Threshold	UVLO	Falling edge of V _{CC} disables ADC	2.25	2.80	2.95	V	
Undervoltage Lockout Hysteresis				90		mV	
Power-On-Reset (POR) Threshold		V _{CC} falling edge	1.3	2.0	2.2	V	
POR Threshold Hysteresis				90		mV	
ALERT and OVERT							
Output Low Voltage	V _{OL}	I _{SINK} = 1mA			0.01	V	
		I _{SINK} = 6mA			0.3		
Input Leakage Current	I _{LEAK}		-1		+1	μA	
SMBus INTERFACE, STBY							
Logic Input Low Voltage	V _{IL}	V _{CC} = 3.6V			0.8	V	
Logic Input High Voltage	V _{IH}	V _{CC} = 3.0V	2.2			V	
Input Leakage Current			-1		+1	μA	
Output Low Voltage	V _{OL}	I _{SINK} = 6mA			0.1	V	
Input Capacitance	C _{IN}			5		pF	
SMBus-COMPATIBLE TIMING (Figures 3 and 4) (Note 3)							
Serial-Clock Frequency	f _{SMBCLK}	(Note 4)			400	kHz	
Bus Free Time Between STOP and START Condition	t _{BUF}	f _{SMBCLK} = 400kHz	1.6			μs	
START Condition Setup Time		f _{SMBCLK} = 400kHz	0.6			μs	
Repeated START Condition Setup Time	t _{SU:STA}	90% of SMBCLK to 90% of SMBDATA, f _{SMBCLK} = 400kHz	50			ns	
START Condition Hold Time	t _{HD:STA}	10% of SMBDATA to 90% of SMBCLK, f _{SMBCLK} = 400kHz	0.6			μs	
STOP Condition Setup Time	t _{SU:STO}	90% of SMBCLK to 90% of SMBDATA, f _{SMBCLK} = 400kHz	0.6			μs	
Clock Low Period	t _{LOW}	10% to 10%, f _{SMBCLK} = 400kHz	1			μs	
Clock High Period	t _{HIGH}	90% to 90%	0.6			μs	
Data-In Hold Time	t _{HD:DAT}		0		0.9	μs	
Data-In Setup Time	t _{SU:DAT}	(Note 5)	100			ns	

Electrical Characteristics (continued)

(V_{CC} = +3.0V to +3.6V, T_A = -40°C to +125°C, unless otherwise noted. Typical values are at V_{CC} = +3.3V and T_A = +25°C.) (Note 2)

PARAMETER	SYMBOL	CONDITIONS	MIN	TYP	MAX	UNITS
Receive SMBCLK/SMBDATA Rise Time	t _R				300	ns
Receive SMBCLK/SMBDATA Fall Time	t _F				300	ns
Data-Out Hold Time	t _{DH}		50			ns
Pulse Width of Spike Suppressed	t _{SP}		0		50	ns
SMBus Timeout	t _{TIMEOUT}	SMBDATA low period for interface reset	25	37	45	ms

Note 2: All parameters are tested at T_A = +85°C. Specifications over temperature are guaranteed by design.

Note 3: Timing specifications are guaranteed by design.

Note 4: The serial interface resets when SMBCLK is low for more than t_{TIMEOUT}.

Note 5: A transition must internally provide at least a hold time to bridge the undefined region (300ns max) of SMBCLK's falling edge.

Typical Operating Characteristics

(V_{CC} = +3.3V, V_{STBY} = V_{CC}, T_A = +25°C, unless otherwise noted.)

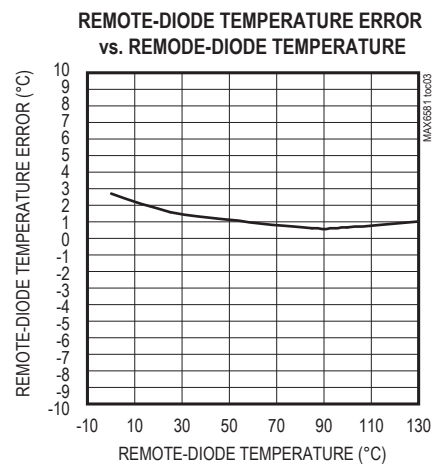
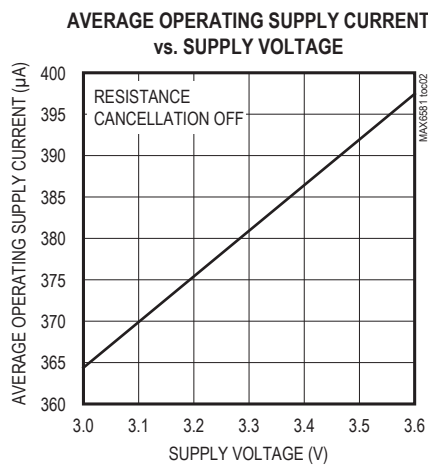
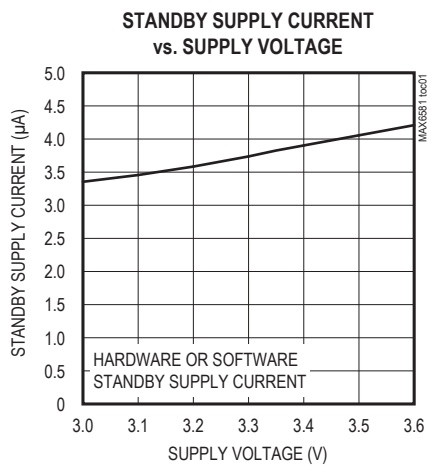

Typical Operating Characteristics (continued)

($V_{CC} = +3.3V$, $V_{STBY} = V_{CC}$, $T_A = +25^\circ C$, unless otherwise noted.)

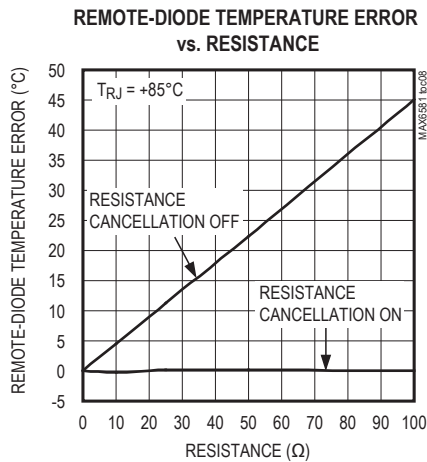
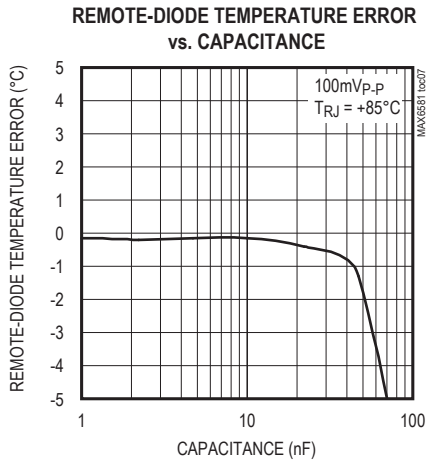
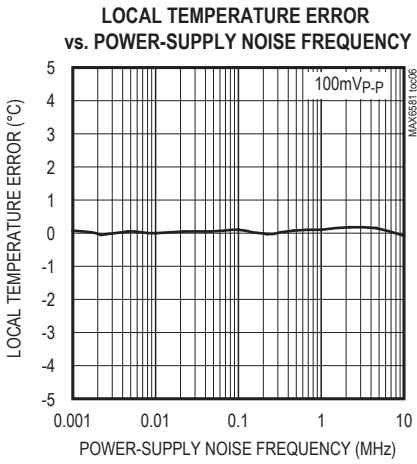
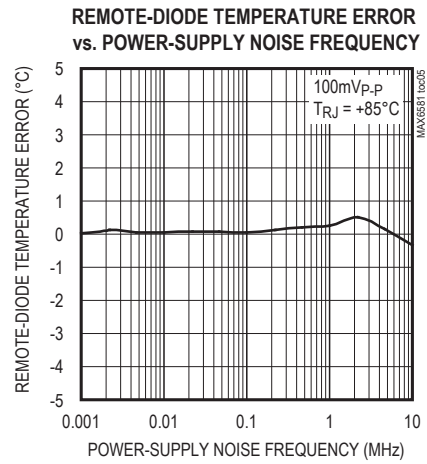
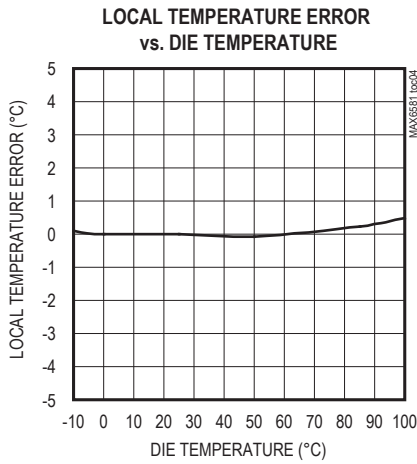

Pin Configuration

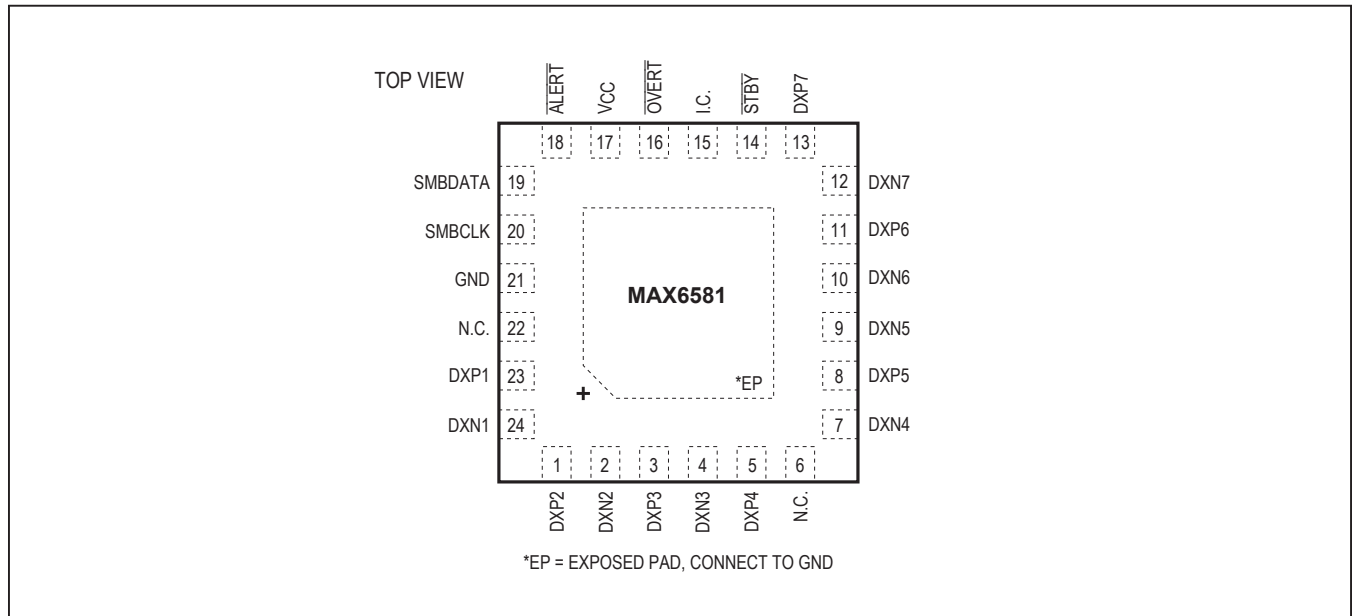

Pin Description

PIN	NAME	FUNCTION
1	DXP2	Combined Current Source and ADC Positive Input for Channel 2 Remote Diode. Connect DXP2 to the anode of a remote-diode-connected, temperature-sensing transistor. Leave DXP2 unconnected or connect to DXN2 if a remote diode is not used. Connect a 100pF capacitor between DXP2 and DXN2 for noise filtering.
2	DXN2	Cathode Input for Channel 2 Remote Diode. Connect the cathode of the channel 2 remote-diode-connected transistor to DXN2. If the channel 2 remote transistor is a substrate pnp (e.g., on a CPU die), connect the base of the pnp to DXN2. Leave DXN2 unconnected or connect to DXP2 if a remote diode is not used. Connect a 100pF capacitor between DXP2 and DXN2 for noise filtering.
3	DXP3	Combined Current Source and ADC Positive Input for Channel 3 Remote Diode. Connect DXP3 to the anode of a remote-diode-connected, temperature-sensing transistor. Leave DXP3 unconnected or connect to DXN3 if a remote diode is not used. Connect a 100pF capacitor between DXP3 and DXN3 for noise filtering.
4	DXN3	Cathode Input for Channel 3 Remote Diode. Connect the cathode of the channel 3 remote-diode-connected transistor to DXN3. If the channel 3 remote transistor is a substrate pnp (e.g., on a CPU die), connect the base of the pnp to DXN3. Leave DXN3 unconnected or connect to DXP3 if a remote diode is not used. Connect a 100pF capacitor between DXP3 and DXN3 for noise filtering.
5	DXP4	Combined Current Source and ADC Positive Input for Channel 4 Remote Diode. Connect DXP4 to the anode of a remote-diode-connected, temperature-sensing transistor. Leave DXP4 unconnected or connect to DXN4 if a remote diode is not used. Connect a 100pF capacitor between DXP4 and DXN4 for noise filtering.
6, 22	N.C.	No Connection. Connect to other N.C. or leave unconnected.

Pin Description (continued)

PIN	NAME	FUNCTION
7	DXN4	Cathode Input for Channel 4 Remote Diode. Connect the cathode of the channel 4 remote-diode-connected transistor to DXN4. If the channel 4 remote transistor is a substrate pnp (e.g., on a CPU die), connect the base of the pnp to DXN4. Leave DXN4 unconnected or connect to DXP4 if a remote diode is not used. Connect a 100pF capacitor between DXP4 and DXN4 for noise filtering.
8	DXP5	Combined Current Source and ADC Positive Input for Channel 5 Remote Diode. Connect DXP5 to the anode of a remote-diode-connected, temperature-sensing transistor. Leave DXP5 unconnected or connect to DXN5 if a remote diode is not used. Connect a 100pF capacitor between DXP5 and DXN5 for noise filtering.
9	DXN5	Cathode Input for Channel 5 Remote Diode. Connect the cathode of the channel 5 remote-diode-connected transistor to DXN5. If the channel 5 remote transistor is a substrate pnp (e.g., on a CPU die), connect the base of the pnp to DXN5. Leave DXN5 unconnected or connect to DXP5 if a remote diode is not used. Connect a 100pF capacitor between DXP5 and DXN5 for noise filtering.
10	DXN6	Cathode Input for Channel 6 Remote Diode. Connect the cathode of the channel 6 remote-diode-connected transistor to DXN6. If the channel 6 remote transistor is a substrate pnp (e.g., on a CPU die), connect the base of the pnp to DXN6. Leave DXN6 unconnected or connect to DXP6 if a remote diode is not used. Connect a 100pF capacitor between DXP6 and DXN6 for noise filtering.
11	DXP6	Combined Current Source and ADC Positive Input for Channel 6 Remote Diode. Connect DXP6 to the anode of a remote-diode-connected, temperature-sensing transistor. Leave DXP6 unconnected or connect to DXN6 if a remote diode is not used. Connect a 100pF capacitor between DXP6 and DXN6 for noise filtering.
12	DXN7	Cathode Input for Channel 7 Remote Diode. Connect the cathode of the channel 7 remote-diode-connected transistor to DXN7. If the channel 7 remote transistor is a substrate pnp (e.g., on a CPU die), connect the base of the pnp to DXN7. Leave DXN7 unconnected or connect to DXP7 if a remote diode is not used. Connect a 100pF capacitor between DXP7 and DXN7 for noise filtering.
13	DXP7	Combined Current Source and ADC Positive Input for Channel 7 Remote Diode. Connect DXP7 to the anode of a remote-diode-connected, temperature-sensing transistor. Leave DXP7 unconnected or connect to DXN7 if a remote diode is not used. Place a 100pF capacitor between DXP7 and DXN7 for noise filtering.
14	$\overline{\text{STBY}}$	Active-Low Standby Input. Drive $\overline{\text{STBY}}$ logic-low to place the MAX6581 in standby mode, or logic-high for normal mode. Temperature and threshold data are retained in standby mode.
15	I.C.	Internally Connected. I.C. is internally connected to V_{CC} . Connect I.C. to V_{CC} or leave unconnected.
16	$\overline{\text{OVERT}}$	Overtemperature Active-Low, Open-Drain Output. $\overline{\text{OVERT}}$ asserts low when the temperature of any remote channel exceeds the programmed threshold limit.
17	V_{CC}	Supply Voltage Input. Bypass to GND with a 0.1 μ F capacitor.
18	$\overline{\text{ALERT}}$	SMBus Alert (Interrupt), Active-Low, Open-Drain Output. $\overline{\text{ALERT}}$ asserts low when the temperature of any channel crosses a programmed $\overline{\text{ALERT}}$ high or low threshold.
19	SMBDATA	SMBus Serial-Data Input/Output. Connect SMBDATA to a pullup resistor.
20	SMBCLK	SMBus Serial-Clock Input. Connect SMBCLK to a pullup resistor.

Pin Description (continued)

PIN	NAME	FUNCTION
21	GND	Ground
23	DXP1	Combined Current Source and ADC Positive Input for Channel 1 Remote Diode. Connect DXP1 to the anode of a remote-diode-connected, temperature-sensing transistor. Leave DXP1 unconnected or connect to DXN1 if a remote diode is not used. Connect a 100pF capacitor between DXP1 and DXN1 for noise filtering.
24	DXN1	Cathode Input for Channel 1 Remote Diode. Connect the cathode of the channel 1 remote-diode-connected transistor to DXN1. If the channel 1 remote transistor is a substrate pnp (e.g., on a CPU die), connect the base of the pnp to DXN1. Leave DXN1 unconnected or connect to DXP1 if a remote diode is not used. Connect a 100pF capacitor between DXP1 and DXN1 for noise filtering.
—	EP	Exposed Pad. Connect EP to GND.

Detailed Description

The MAX6581 is a precision multichannel temperature monitor that features one local and seven remote temperature-sensing channels with a programmable alert threshold for each temperature channel and a programmable overtemperature threshold for channels 1–7 (see Figure 1). Communication with the MAX6581 is achieved through the SMBus serial interface and a dedicated alert pin ($\overline{\text{ALERT}}$). The alarm outputs, ($\overline{\text{OVERT}}$ and $\overline{\text{ALERT}}$) assert if the software-programmed temperature thresholds are exceeded. $\overline{\text{ALERT}}$ also asserts if the measured temperature falls below the $\overline{\text{ALERT}}$ low limits. $\overline{\text{ALERT}}$ typically serves as an interrupt, while $\overline{\text{OVERT}}$ can be connected to a fan, system shutdown, or other thermal-management circuitry.

ADC Conversion Sequence

The MAX6581 starts the conversion sequence by measuring the temperature on channel 1, followed by 2, local channel, 3–7. The conversion result for each active channel is stored in the corresponding temperature data register. No conversion is performed on any channel that does not have a diode.

Low-Power Standby Mode

Enter software-standby mode by setting the STOP bit to 1 in the Configuration register. Enter hardware-standby by pulling $\overline{\text{STBY}}$ low. Software-standby mode disables the ADC and reduces the supply current to approximately 4μA. During either software or hardware standby, data is retained in memory. During hardware standby, the SMBus

interface is inactive. During software standby, the SMBus interface is active and listening for commands. The timeout is enabled if a START condition is recognized on SMBus. Activity on the SMBus causes the supply current to increase. If a standby command is received while a conversion is in progress, the conversion cycle is interrupted, and the temperature registers are not updated. The previous data is not changed and remains available.

Operating-Current Calculation

The MAX6581 operates at different operating-current levels depending on how many external channels are in use and how many of those are in resistance cancellation (RC) mode. The average operating current is:

$$I_{AV} = \frac{N_N + 1}{N_N + 2 \times N_R + 1} I_{CC1} + \frac{2 \times N_R}{N_N + 2 \times N_R + 1} \times I_{CC2}$$

where:

N_N = the number of remote channels that are operating in normal mode.

N_R = the number of remote channels that are in RC mode.

I_{AV} = the average operating power-supply current over a complete series of conversions.

I_{CC1} = the average operating power-supply current during a conversion in normal mode.

I_{CC2} = the average operating power-supply current during a conversion in RC mode.

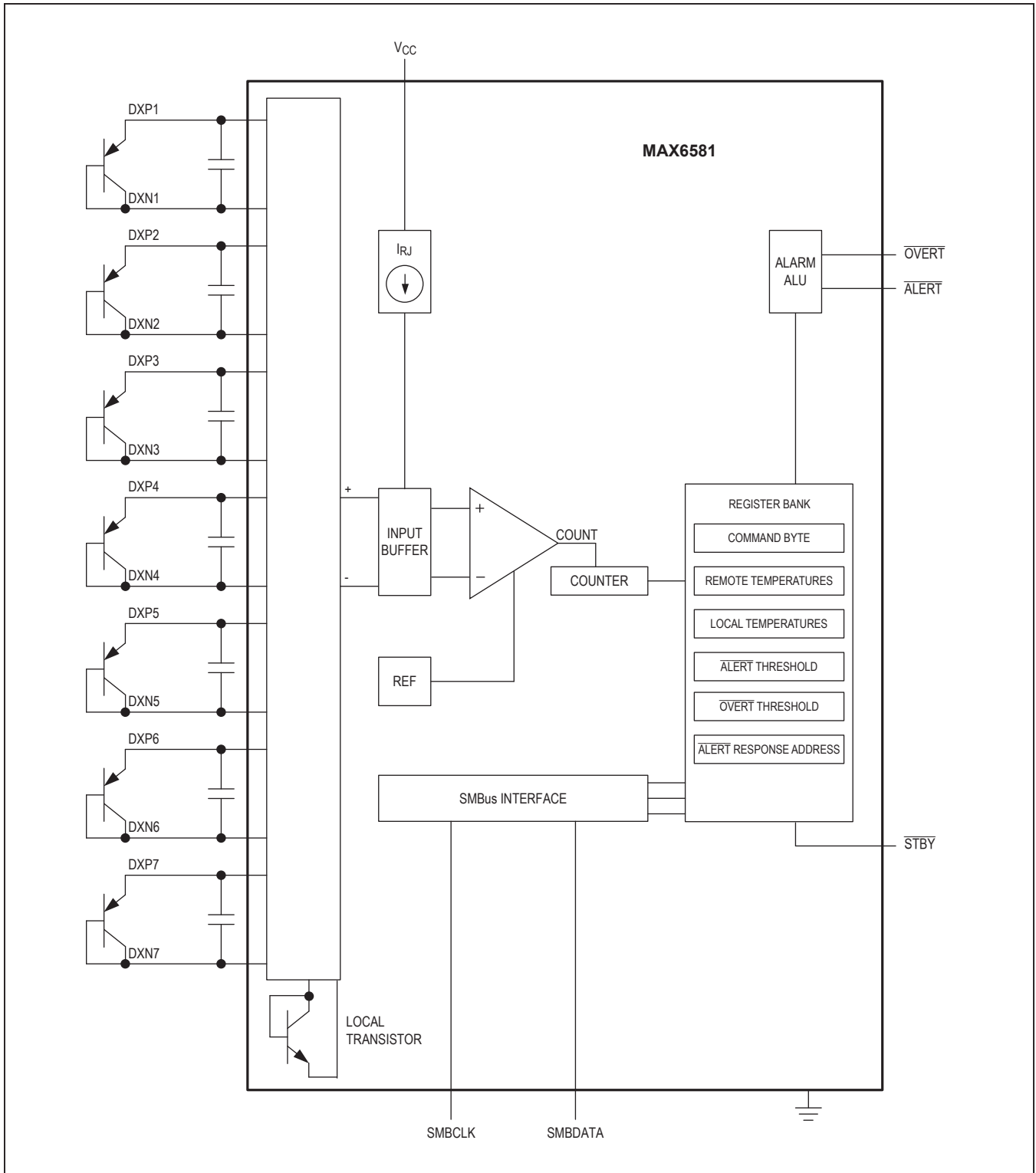

Figure 1. Internal Block Diagram

SMBus Digital Interface

From a software perspective, the MAX6581 appears as a series of 8-bit registers that contain temperature-measurement data, alarm threshold values, and control bits. A standard SMBus-compatible, 2-wire serial interface is used to read temperature data and write control bits and alarm threshold data. The same SMBus slave address also provides access to all functions.

The MAX6581 employs four standard SMBus protocols: write byte, read byte, send byte, and receive byte (Figure 2). The shorter receive-byte protocol allows quicker transfers, provided that the correct data register was previously selected by a read-byte instruction. Use caution with the shorter protocols in multimaster systems, since a second master could overwrite the command byte without inform-

ing the first master. Figure 3 is the SMBus write timing diagram and Figure 4 is the SMBus read timing diagram.

The remote-diode-measurement channels provide 11 bits of data (1 LSB = 0.125°C). The eight most significant bits (MSBs) can be read from the local temperature and remote temperature registers. The remaining 3 bits for remote can be read from the extended temperature register. If extended resolution is desired, the extended-resolution register should be read first. This prevents the MSBs from being overwritten by new conversion results until they have been read. If the MSBs have not been read within a SMBus timeout period (nominally 37ms), normal updating continues. Table 1 shows the main temperature register (high-byte) data format and Table 2 shows the extended-resolution register (low-byte) data format.

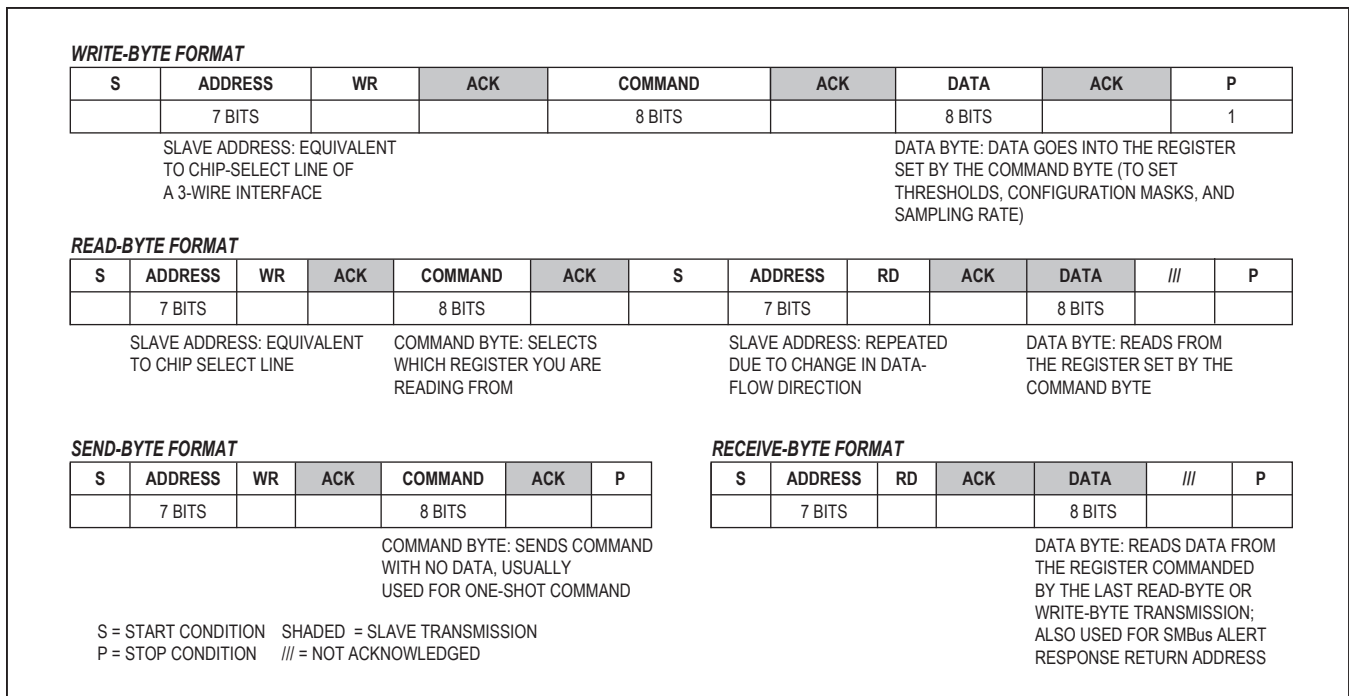

Figure 2. SMBus Protocols

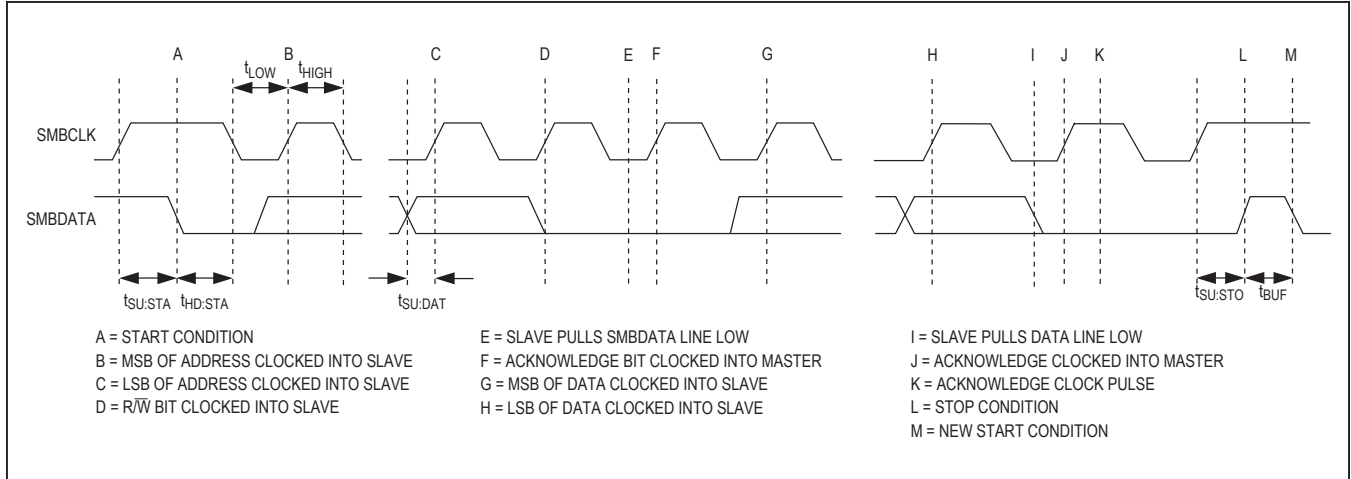

Figure 3. SMBus Write Timing Diagram

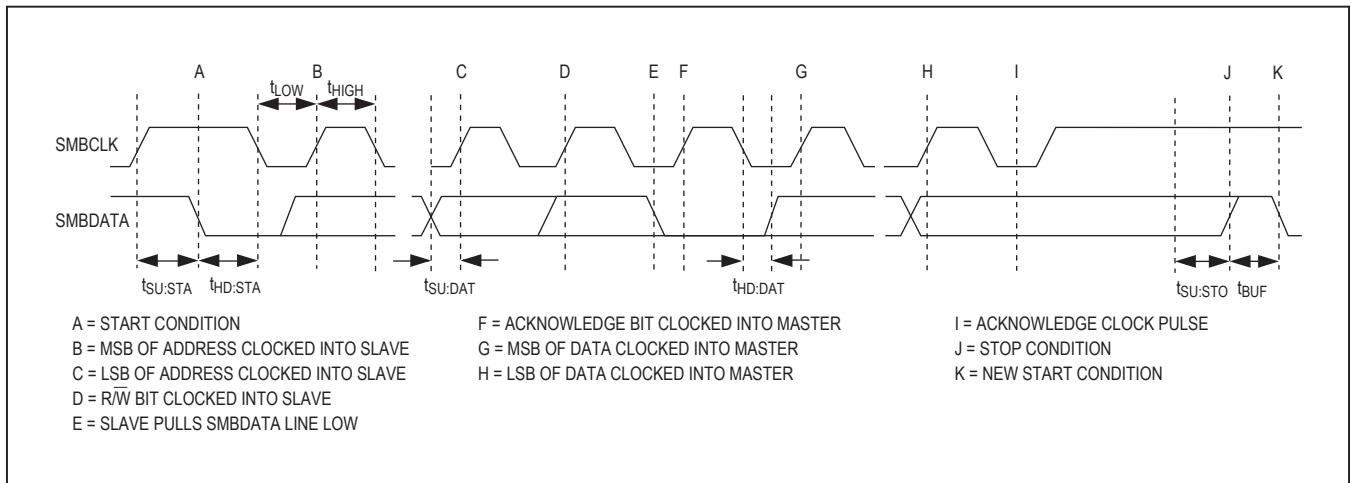

Figure 4. Read-Timing Diagram

Table 1. Main Temperature Register (High-Byte) Data Format

TEMPERATURE (°C)	DIGITAL OUTPUT	
	NORMAL FORMAT EXTRANGE = 0	EXTENDED FORMAT EXTRANGE = 1
Diode fault (open or short)	1111 1111	1111 1111
> +254	1111 1111	1111 1111
+254	1111 1110	1111 1111
+191	1011 1111	1111 1111
+190	1011 1110	1111 1110
+125	0111 1101	1011 1101
+85	0101 0101	1001 0101
+25	0001 1001	0101 1001
0	0000 0000	0100 0000
-1	0000 0000	0011 1111
-40	0000 0000	0001 1000
-63	0000 0000	0000 0001
-64	0000 0000	0000 0000
< -64	0000 0000	0000 0000

Table 2. Extended-Resolution Temperature Register (Low-Byte) Data Format

TEMPERATURE (°C)	DIGITAL OUTPUT
0	000X XXXX
+0.125	001X XXXX
+0.250	010X XXXX
+0.375	011X XXXX
+0.500	100X XXXX
+0.625	101X XXXX
+0.750	110X XXXX
+0.875	111X XXXX

X = Don't care.

Table 3. Command Byte Register Bit Assignment

REGISTER	ADDRESS (HEX)	POR VALUE (HEX)	READ/ WRITE	DESCRIPTION
Remote 1	01	00	R	Read channel 1 remote temperature
Remote 2	02	00	R	Read channel 2 remote temperature
Remote 3	03	00	R	Read channel 3 remote temperature
Remote 4	04	00	R	Read channel 4 remote temperature
Remote 5	05	00	R	Read channel 5 remote temperature
Remote 6	06	00	R	Read channel 6 remote temperature
Local	07	00	R	Read local temperature
Remote 7	08	00	R	Read channel 7 remote temperature
Remote 1 Extended Bits*	09	00	R	Read channel 1 remote-diode extended temperature
Manufacturer ID	0A	4D	R	Read manufacturer ID
Revision ID	0F	00	R	Read revision ID
Remote 1 ALERT High Limit	11	7F	R/W	Read/write channel 1 remote-diode alert high-temperature threshold limit
Remote 2 ALERT High Limit	12	7F	R/W	Read/write channel 2 remote-diode alert high-temperature threshold limit
Remote 3 ALERT High Limit	13	64	R/W	Read/write channel 3 remote-diode alert high-temperature threshold limit
Remote 4 ALERT High Limit	14	64	R/W	Read/write channel 4 remote-diode alert high-temperature threshold limit
Remote 5 ALERT High Limit	15	64	R/W	Read/write channel 5 remote-diode alert high-temperature threshold limit
Remote 6 ALERT High Limit	16	64	R/W	Read/write channel 6 remote-diode alert high-temperature threshold limit
Local ALERT High Limit	17	5A	R/W	Read/write local-diode alert high-temperature threshold limit
Remote 7 ALERT High Limit	18	64	R/W	Read/write channel 7 remote-diode alert high-temperature threshold limit
Local OVERT High Limit	20	50	R/W	Read/write channel local-diode overtemperature threshold limit
Remote 1 OVERT High Limit	21	6E	R/W	Read/write channel 1 remote-diode overtemperature threshold limit
Remote 2 OVERT High Limit	22	6E	R/W	Read/write channel 2 remote-diode overtemperature threshold limit
Remote 3 OVERT High Limit	23	6E	R/W	Read/write channel 3 remote-diode overtemperature threshold limit
Remote 4 OVERT High Limit	24	7F	R/W	Read/write channel 4 remote-diode overtemperature threshold limit
Remote 5 OVERT High Limit	25	5A	R/W	Read/write channel 5 remote-diode overtemperature threshold limit
Remote 6 OVERT High Limit	26	5A	R/W	Read/write channel 6 remote-diode overtemperature threshold limit

Table 3. Command Byte Register Bit Assignment (continued)

REGISTER	ADDRESS (HEX)	POR VALUE (HEX)	READ/ WRITE	DESCRIPTION
Remote 7 $\overline{\text{OVERT}}$ High Limit	27	5A	R/W	Read/write channel 7 remote-diode overtemperature threshold limit
$\overline{\text{ALERT}}$ Low Limits (all channels)	30	00	R/W	Read/write all channels alert low-temperature threshold limit
Configuration	41	00	R/W	Read/write configuration
$\overline{\text{ALERT}}$ Mask	42	00	R/W	Read/write $\overline{\text{ALERT}}$ mask
$\overline{\text{OVERT}}$ Mask	43	00	R/W	Read/write $\overline{\text{OVERT}}$ mask
$\overline{\text{ALERT}}$ High Status	44	00	R	Read $\overline{\text{ALERT}}$ high status
$\overline{\text{OVERT}}$ Status	45	00	R	Read $\overline{\text{OVERT}}$ status
Diode Fault Status	46	00	R	Read diode fault status
$\overline{\text{ALERT}}$ Low Status	47	00	R	Read $\overline{\text{ALERT}}$ low status
$\overline{\text{ALERT}}$ Low Disable	48	FF	R/W	Read/write $\overline{\text{ALERT}}$ low disable
Resistance Cancellation	4A	00	R/W	Read/write resistance cancellation enable bits (1 = On, 0 = Off)
Transistor Ideality	4B	00	R/W	Read/write ideality value for remote-sense transistor
Ideality Select	4C	00	R/W	Read/write ideality value selection bits (1 = selected transistor ideality, 0 = 1.008)
Offset	4D	00	R/W	Read/write temperature offset value
Offset Select	4E	00	R/W	Read/write offset value selection bits (1 = value in Offset register, 0 = 0)
Remote 1 Extended Bits*	51	00	R	Read channel 1 remote extended temperature
Remote 2 Extended Bits	52	00	R	Read channel 2 remote extended temperature
Remote 3 Extended Bits	53	00	R	Read channel 3 remote extended temperature
Remote 4 Extended Bits	54	00	R	Read channel 4 remote extended temperature
Remote 5 Extended Bits	55	00	R	Read channel 5 remote extended temperature
Remote 6 Extended Bits	56	00	R	Read channel 6 remote extended temperature
Local Extended Bits	57	00	R	Read local channel extended temperature
Remote 7 Extended Bits	58	00	R	Read channel 7 remote extended temperature

*Duplicate entries.

Diode Fault Detection

If a channel's input DXP_n and DXN_n are left open or are shorted, the MAX6581 detects a diode fault. An open diode fault does not cause either $\overline{\text{ALERT}}$ or $\overline{\text{OVERT}}$ to assert. A bit in the status register for the corresponding channel is set to 1 and the temperature data for the channel is stored as all 1s (FFh). It takes approximately 4ms for the MAX6581 to detect a diode fault. Once a diode fault is detected, the MAX6581 goes to the next channel in the conversion sequence.

Alarm Threshold Registers

There are 17 alarm threshold registers that store overtemperature and undertemperature $\overline{\text{ALERT}}$ and $\overline{\text{OVERT}}$ threshold values. Nine of these registers are dedicated to storing one local alert overtemperature threshold limit, seven remote alert overtemperature threshold limits, and one shared alert undertemperature temperature threshold limit (see the *$\overline{\text{ALERT}}$ Interrupt Mode* section). The remaining eight registers are dedicated to storing one local overtemperature threshold limit and seven remote channels to store overtemperature threshold limits (see the *$\overline{\text{OVERT}}$ Overtemperature Alarms* section). Access to these registers is provided through the SMBus interface.

$\overline{\text{ALERT}}$ Interrupt Mode

$\overline{\text{ALERT}}$ interrupts occur when the internal or external temperature reading exceeds a high-temperature limit (user programmable) or a low-temperature limit. The $\overline{\text{ALERT}}$ interrupt output signal can be cleared by reading the status register(s) associated with the fault(s) or by successfully responding to an alert response address transmission by the master. In both cases, the alert is cleared but is reasserted at the end of the next conversion if the fault condition still exists. The interrupt does not halt automatic conversions. The $\overline{\text{ALERT}}$ output is open-drain so that multiple devices can share a common interrupt line. All $\overline{\text{ALERT}}$ interrupts can be masked using the $\overline{\text{ALERT}}$ Mask register (42h). The POR state of these registers is shown in Table 3.

$\overline{\text{ALERT}}$ Responses Address

The SMBus alert response interrupt pointer provides quick fault identification for simple slave devices that lack the complex logic necessary to be a bus master. Upon receiving an interrupt signal, the host master can broadcast a receive-byte transmission to the alert response slave address (19h). Then, any slave device that generated an interrupt attempts to identify itself by putting its own address on the bus.

The alert response can activate several different slave devices simultaneously, similar to the I²C general call. If

more than one slave attempts to respond, bus arbitration rules apply, and the device with the lower address code wins. The losing device does not generate an acknowledgment and continues to hold the $\overline{\text{ALERT}}$ line low until cleared (the conditions for clearing an alert vary depending on the type of slave device.) Successful completion of the alert response protocol clears the output latch. If the condition that caused the alert still exists, the MAX6581 reasserts the $\overline{\text{ALERT}}$ interrupt at the end of the next conversion.

$\overline{\text{OVERT}}$ Overtemperature Alarms

The MAX6581 has eight overtemperature registers that store alarm threshold data for the $\overline{\text{OVERT}}$ output. $\overline{\text{OVERT}}$ is asserted when a channel's measured temperature is greater than the value stored in the corresponding threshold register. $\overline{\text{OVERT}}$ remains asserted until the temperature drops below the programmed threshold minus 4°C hysteresis. An overtemperature output can be used to activate a cooling fan, send a warning, initiate clock throttling, or trigger a system shutdown to prevent component damage. See Table 3 for the POR state of the overtemperature threshold registers.

Command Byte Register Functions

The 8-bit Command Byte register (Table 3) is the master index that points to the various other registers within the MAX6581. This register's POR state is 0000 0000 (00h).

Configuration Register (41h)

The Configuration register (Table 4) has several functions. Bit 7 (MSB) is used to put the MAX6581 either in software-standby mode (STOP) or continuous-conversion mode. Bit 6 resets all registers to their POR conditions and then clears itself. Bit 5 disables the SMBus timeout. Bit 1 sets the extended range of the remote temperature diodes. The remaining bits of the Configuration register are not used. The POR state of this register is 0000 0000 (00h).

$\overline{\text{ALERT}}$ Mask Register (42h)

The $\overline{\text{ALERT}}$ Mask register functions are described in Table 5. Bits [7:0] are used to mask the $\overline{\text{ALERT}}$ interrupt output. Bit 6 masks the local alert interrupt and the remaining bits mask the remote alert interrupts. The power-up state of this register is 0000 0000 (00h).

$\overline{\text{OVERT}}$ Mask Register (43h)

Table 6 describes the $\overline{\text{OVERT}}$ Mask register. Bit 7 and the remaining bits mask the $\overline{\text{OVERT}}$ interrupt output for all channels. The power-up state of this register is 0000 0000 (00h).

Table 4. Configuration Register (41h)

BIT	NAME	POR VALUE	FUNCTION
7 (MSB)	STOP	0	Standby-Mode Control Bit. If STOP is set to logic 1, the MAX6581 stops converting and enters standby mode.
6	POR	0	Reset Bit. Set to logic 1 to put the device into its power-on state. This bit is self-clearing.
5	TIMEOUT	0	Timeout Enable Bit. Set to logic 0 to enable SMBus timeout.
4	RESERVED	0	Reserved. Must be set to 0.
3	RESERVED	0	Reserved. Must be set to 0.
2	RESERVED	0	Reserved. Must be set to 0.
1	EXTRANGE	0	Extended-Range Enable Bit. Set bit 1 to logic 1 to set the temperature and limit data range to -64°C to +191°C. Set bit 1 to logic 0 to set the range to 0°C to +255°C.
0	RESERVED	0	Reserved. Must be set to 0.

Table 5. ALERT Mask Register (42h)

BIT	NAME	POR VALUE	FUNCTION
7 (MSB)	Mask ALERT 7	0	Channel 7 Alert Mask. Set to logic 1 to mask channel 7 ALERT.
6	Mask Local ALERT	0	Local Alert Mask. Set to logic 1 to mask local channel ALERT.
5	Mask ALERT 6	0	Channel 6 Alert Mask. Set to logic 1 to mask channel 6 ALERT.
4	Mask ALERT 5	0	Channel 5 Alert Mask. Set to logic 1 to mask channel 5 ALERT.
3	Mask ALERT 4	0	Channel 4 Alert Mask. Set to logic 1 to mask channel 4 ALERT.
2	Mask ALERT 3	0	Channel 3 Alert Mask. Set to logic 1 to mask channel 3 ALERT.
1	Mask ALERT 2	0	Channel 2 Alert Mask. Set to logic 1 to mask channel 2 ALERT.
0	Mask ALERT 1	0	Channel 1 Alert Mask. Set to logic 1 to mask channel 1 ALERT.

Table 6. OVERT Mask Register (43h)

BIT	NAME	POR VALUE	FUNCTION
7 (MSB)	Mask Local OVERT	0	Local Overt Mask. Set to logic 1 to mask local channel OVERT.
6	Mask OVERT 7	0	Channel 7 Remote-Diode OVERT Mask Bit. Set to logic 1 to mask channel 7 OVERT.
5	Mask OVERT 6	0	Channel 6 Remote-Diode OVERT Mask Bit. Set to logic 1 to mask channel 6 OVERT.
4	Mask OVERT 5	0	Channel 5 Remote-Diode OVERT Mask Bit. Set to logic 1 to mask channel 5 OVERT.
3	Mask OVERT 4	0	Channel 4 Remote-Diode OVERT Mask Bit. Set to logic 1 to mask channel 4 OVERT.
2	Mask OVERT 3	0	Channel 3 Remote-Diode OVERT Mask Bit. Set to logic 1 to mask channel 3 OVERT.
1	Mask OVERT 2	0	Channel 2 Remote-Diode OVERT Mask Bit. Set to logic 1 to mask channel 2 OVERT.
0	Mask OVERT 1	0	Channel 1 Remote-Diode OVERT Mask Bit. Set to logic 1 to mask channel 1 OVERT.

Status Register Functions

There are four status registers (see Tables 7–10). The $\overline{\text{ALERT}}$ High Status register indicates whether a measured local or remote temperature has exceeded the associated threshold limit set in an $\overline{\text{ALERT}}$ High Limit register. The $\overline{\text{OVERT}}$ Status register indicates whether a measured temperature has exceeded the associated threshold limit set in an $\overline{\text{OVERT}}$ High Limit register. The Diode Fault Status register indicates whether there is a diode fault (open or short) in any of the remote-sensing channels. The $\overline{\text{ALERT}}$ Low Status register indicates whether the measured temperature has fallen below the threshold limit set in the $\overline{\text{ALERT}}$ Low Limits register for the local or remote-sensing diodes.

Bits in the alert status registers are cleared by a successful read, but set again after the next conversion unless

the fault is corrected, either by a drop in the measured temperature or a change in the threshold temperature.

The $\overline{\text{ALERT}}$ interrupt output follows the status flag bit. Once the $\overline{\text{ALERT}}$ output is asserted, it can be deasserted by either reading the $\overline{\text{ALERT}}$ High Status register or by successfully responding to an alert response address. In both cases, the alert is cleared even if the fault condition exists, but the $\overline{\text{ALERT}}$ output reasserts at the end of the next conversion.

The bits indicating $\overline{\text{OVERT}}$ faults clear only when the measured temperature drops below the temperature threshold minus the hysteresis value (4°C), or when the trip temperature is set to a value at least 4°C above the current temperature.

Table 7. $\overline{\text{ALERT}}$ High Status Register (44h)

BIT	NAME	POR STATE	FUNCTION
7 (MSB)	Remote $\overline{\text{ALERT}}$ High 7	0	Channel 7 Remote-Diode High-Alert Bit. This bit is set to logic 1 when the channel 7 remote-diode temperature exceeds the programmed temperature threshold limit in the Remote 7 $\overline{\text{ALERT}}$ High Limit register.
6	Local $\overline{\text{ALERT}}$ High	0	Local Channel High-Alert Bit. This bit is set to logic 1 when the local temperature exceeds the temperature threshold limit in the Local $\overline{\text{ALERT}}$ High Limit register.
5	Remote $\overline{\text{ALERT}}$ High 6	0	Channel 6 Remote-Diode High-Alert Bit. This bit is set to logic 1 when the channel 6 remote-diode temperature exceeds the programmed temperature threshold limit in the Remote 6 $\overline{\text{ALERT}}$ High Limit register.
4	Remote $\overline{\text{ALERT}}$ High 5	0	Channel 5 Remote-Diode High-Alert Bit. This bit is set to logic 1 when the channel 5 remote-diode temperature exceeds the programmed temperature threshold limit in the Remote 5 $\overline{\text{ALERT}}$ High Limit register.
3	Remote $\overline{\text{ALERT}}$ High 4	0	Channel 4 Remote-Diode High-Alert Bit. This bit is set to logic 1 when the channel 4 remote-diode temperature exceeds the programmed temperature threshold limit in the Remote 4 $\overline{\text{ALERT}}$ High Limit register.
2	Remote $\overline{\text{ALERT}}$ High 3	0	Channel 3 Remote-Diode High-Alert Bit. This bit is set to logic 1 when the channel 3 remote-diode temperature exceeds the programmed temperature threshold limit in the Remote 3 $\overline{\text{ALERT}}$ High Limit register.
1	Remote $\overline{\text{ALERT}}$ High 2	0	Channel 2 Remote-Diode High-Alert Bit. This bit is set to logic 1 when the channel 2 remote-diode temperature exceeds the programmed temperature threshold limit in the Remote 2 $\overline{\text{ALERT}}$ High Limit register.
0	Remote $\overline{\text{ALERT}}$ High 1	0	Channel 1 Remote-Diode High-Alert Bit. This bit is set to logic 1 when the channel 1 remote-diode temperature exceeds the programmed temperature threshold limit in the Remote 1 $\overline{\text{ALERT}}$ High Limit register.

Table 8. $\overline{\text{OVERT}}$ Status Register (45h)

BIT	NAME	POR STATE	FUNCTION
7 (MSB)	Local $\overline{\text{OVERT}}$	0	Local Channel Overtemperature Status Bit. This bit is set to logic 1 when the local temperature exceeds the temperature threshold limit in the Local $\overline{\text{OVERT}}$ High Limit register.
6	Remote $\overline{\text{OVERT}}$ 7	0	Channel 7 Remote-Diode Overtemperature Status Bit. This bit is set to logic 1 when the channel 7 remote-diode temperature exceeds the temperature threshold limit in the Remote 7 $\overline{\text{OVERT}}$ High Limit register.
5	Remote $\overline{\text{OVERT}}$ 6	0	Channel 6 Remote-Diode Overtemperature Status Bit. This bit is set to logic 1 when the channel 6 remote-diode temperature exceeds the temperature threshold limit in the Remote 6 $\overline{\text{OVERT}}$ High Limit register.
4	Remote $\overline{\text{OVERT}}$ 5	0	Channel 5 Remote-Diode Overtemperature Status Bit. This bit is set to logic 1 when the channel 5 remote-diode temperature exceeds the temperature threshold limit in the Remote 5 $\overline{\text{OVERT}}$ High Limit register.
3	Remote $\overline{\text{OVERT}}$ 4	0	Channel 4 Remote-Diode Overtemperature Status Bit. This bit is set to logic 1 when the channel 4 remote-diode temperature exceeds the temperature threshold limit in the Remote 4 $\overline{\text{OVERT}}$ High Limit register.
2	Remote $\overline{\text{OVERT}}$ 3	0	Channel 3 Remote-Diode Overtemperature Status Bit. This bit is set to logic 1 when the channel 3 remote-diode temperature exceeds the temperature threshold limit in the Remote 3 $\overline{\text{OVERT}}$ High Limit register.
1	Remote $\overline{\text{OVERT}}$ 2	0	Channel 2 Remote-Diode Overtemperature Status Bit. This bit is set to logic 1 when the channel 2 remote-diode temperature exceeds the temperature threshold limit in the Remote 2 $\overline{\text{OVERT}}$ High Limit register.
0	Remote $\overline{\text{OVERT}}$ 1	0	Channel 1 Remote-Diode Overtemperature Status Bit. This bit is set to logic 1 when the channel 1 remote-diode temperature exceeds the temperature threshold limit in the Remote 1 $\overline{\text{OVERT}}$ High Limit register.

Table 9. Diode Fault Status Register (46h)

BIT	NAME	POR STATE	FUNCTION
7 (MSB)	RESERVED	0	—
6	Diode Fault 7	0	Channel 7 Remote-Diode Fault Bit. This bit is set to 1 when DXP7 and DXN7 are open circuit or when DXP7 is connected to V_{CC} .
5	Diode Fault 6	0	Channel 6 Remote-Diode Fault Bit. This bit is set to 1 when DXP6 and DXN6 are open circuit or when DXP6 is connected to V_{CC} .
4	Diode Fault 5	0	Channel 5 Remote-Diode Fault Bit. This bit is set to 1 when DXP5 and DXN5 are open circuit or when DXP5 is connected to V_{CC} .
3	Diode Fault 4	0	Channel 4 Remote-Diode Fault Bit. This bit is set to 1 when DXP4 and DXN4 are open circuit or when DXP4 is connected to V_{CC} .
2	Diode Fault 3	0	Channel 3 Remote-Diode Fault Bit. This bit is set to 1 when DXP3 and DXN3 are open circuit or when DXP3 is connected to V_{CC} .
1	Diode Fault 2	0	Channel 2 Remote-Diode Fault Bit. This bit is set to 1 when DXP2 and DXN2 are open circuit or when DXP2 is connected to V_{CC} .
0	Diode Fault 1	0	Channel 1 Remote-Diode Fault Bit. This bit is set to 1 when DXP1 and DXN1 are open circuit or when DXP1 is connected to V_{CC} .

Table 10. ALERT Low Status Register (47h)

BIT	NAME	POR STATE	FUNCTION
7 (MSB)	Remote $\overline{\text{ALERT}}$ Low 7	0	Channel 7 Remote-Diode Low-Alert Bit. This bit is set to logic 1 when the channel 7 remote-diode temperature falls below the programmed temperature threshold limit in the Remote 7 ALERT Low Limit register.
6	Local $\overline{\text{ALERT}}$ Low	0	Local Channel Remote-Diode Low-Alert Bit. This bit is set to logic 1 when the local channel remote-diode temperature falls below the programmed temperature threshold limit in the Local $\overline{\text{ALERT}}$ Low Limit register.
5	Remote $\overline{\text{ALERT}}$ Low 6	0	Channel 6 Remote-Diode Low-Alert Bit. This bit is set to logic 1 when the channel 6 remote-diode temperature falls below the programmed temperature threshold limit in the Remote 6 ALERT Low Limit register.
4	Remote $\overline{\text{ALERT}}$ Low 5	0	Channel 5 Remote-Diode Low-Alert Bit. This bit is set to logic 1 when the channel 5 remote-diode temperature falls below the programmed temperature threshold limit in the Remote 5 $\overline{\text{ALERT}}$ Low Limit register.
3	Remote $\overline{\text{ALERT}}$ Low 4	0	Channel 4 Remote-Diode Low-Alert Bit. This bit is set to logic 1 when the channel 4 remote-diode temperature falls below the programmed temperature threshold limit in the Remote 4 $\overline{\text{ALERT}}$ Low Limit register.
2	Remote $\overline{\text{ALERT}}$ Low 3	0	Channel 3 Remote-Diode Low-Alert Bit. This bit is set to logic 1 when the channel 3 remote-diode temperature falls below the programmed temperature threshold limit in the Remote 3 $\overline{\text{ALERT}}$ Low Limit register.
1	Remote $\overline{\text{ALERT}}$ Low 2	0	Channel 2 Remote-Diode Low-Alert Bit. This bit is set to logic 1 when the channel 2 remote-diode temperature falls below the programmed temperature threshold limit in the Remote 2 $\overline{\text{ALERT}}$ Low Limit register.
0	Remote $\overline{\text{ALERT}}$ Low 1	0	Channel 1 Remote-Diode Low-Alert Bit. This bit is set to logic 1 when the channel 1 remote-diode temperature falls below the programmed temperature threshold limit in the Remote 1 $\overline{\text{ALERT}}$ Low Limit register.

Effect of Ideality Factor

The accuracy of the remote temperature measurements depends on the ideality factor (n) of the remote “diode” (actually a transistor). The default value for the MAX6581 is $n = 1.008$ (channels 1–7). A thermal diode on the substrate of an IC is normally a pnp with the base and emitter brought out and the collector (diode connection) grounded. DXP_ must be connected to the anode (emitter) and DXN_ must be connected to the cathode (base)

of this pnp. If a sense transistor with an ideality factor other than 1.008 is used, the output data is different from the data obtained with the optimum ideality factor. If necessary, a different ideality factor value can be chosen using the Transistor Ideality register (see Table 11). The Ideality Select register allows each channel to have the default ideality of 1.008 or the value programmed in the Transistor Ideality register.

Table 11. Transistor Ideality Register

REGISTER	B7	B6	B5	B4	B3	B2	B1	B0	IDEALITY FACTOR	HEX
0x4B	X	X	X	0	0	0	0	0	.999	0x00
	X	X	X	0	0	0	0	1	1.000	0x01
	X	X	X	0	0	0	1	0	1.001	0x02
	X	X	X	0	0	0	1	1	1.002	0x03
	X	X	X	0	0	1	0	0	1.003	0x04
	X	X	X	0	0	1	1	0	1.004	0x05
	X	X	X	0	0	1	1	1	1.005	0x06
	X	X	X	0	0	1	1	1	1.006	0x07
	X	X	X	0	1	0	0	0	1.007	0x08
	X	X	X	0	1	0	0	1	1.008	0x09
	X	X	X	0	1	0	1	0	1.009	0x0A
	X	X	X	0	1	0	1	1	1.010	0x0B
	X	X	X	0	1	1	0	0	1.011	0x0C
	X	X	X	0	1	1	0	1	1.012	0x0D
	X	X	X	0	1	1	1	0	1.013	0x0E
	X	X	X	0	1	1	1	1	1.014	0x0F
	X	X	X	1	0	0	0	0	1.015	0x10
	X	X	X	1	0	0	0	1	1.016	0x11
	X	X	X	1	0	0	1	0	1.017	0x12
	X	X	X	1	0	0	1	1	1.018	0x13
	X	X	X	1	0	1	0	0	1.019	0x14
	X	X	X	1	0	1	0	1	1.020	0x15
	X	X	X	1	0	1	1	0	1.021	0x16
	X	X	X	1	0	1	1	1	1.022	0x17
	X	X	X	1	1	0	0	0	1.023	0x18
	X	X	X	1	1	0	0	1	1.024	0x19
	X	X	X	1	1	0	1	0	1.025	0x1A
	X	X	X	1	1	0	1	1	1.026	0x1B
	X	X	X	1	1	1	0	0	1.027	0x1C
	X	X	X	1	1	1	0	1	1.028	0x1D
X	X	X	1	1	1	1	0	1.029	0x1E	
X	X	X	1	1	1	1	1	1.030	0x1F	

X = Don't care.

Series-Resistance Cancellation

Some thermal diodes on high-power ICs have excessive series resistance that can cause temperature-measurement errors when used with conventional remote-temperature sensors. Channels 1–7 of the MAX6581 have a series-resistance cancellation feature (enabled by bits [7:0] of the Resistance Cancellation register) that eliminates the effect of diode series resistance and

interconnection resistance. Set these bits to 1 if the series resistance is large enough to affect the accuracy of the channels. The series-resistance cancellation function increases the conversion time for the remote channels by 125ms (typ). This feature cancels the bulk resistance of the sensor and any other resistance in series (e.g., wire, contact resistance, etc.). The cancellation range is from 0Ω to 100Ω.

Table 12. Resistance Cancellation Register (4Ah)

BIT	NAME	POR STATE	FUNCTION
7 (MSB)	X	0	—
6	Resistance Cancellation 7	0	Channel 7 Resistance Cancellation Enable Bit. Set this bit to logic 1 to enable resistance cancellation. Set this bit to logic 0 to disable resistance cancellation.
5	Resistance Cancellation 6	0	Channel 6 Resistance Cancellation Enable Bit. Set this bit to logic 1 to enable resistance cancellation. Set this bit to logic 0 to disable resistance cancellation.
4	Resistance Cancellation 5	0	Channel 5 Resistance Cancellation Enable Bit. Set this bit to logic 1 to enable resistance cancellation. Set this bit to logic 0 to disable resistance cancellation.
3	Resistance Cancellation 4	0	Channel 4 Resistance Cancellation Enable Bit. Set this bit to logic 1 to enable resistance cancellation. Set this bit to logic 0 to disable resistance cancellation.
2	Resistance Cancellation 3	0	Channel 3 Resistance Cancellation Enable Bit. Set this bit to logic 1 to enable resistance cancellation. Set this bit to logic 0 to disable resistance cancellation.
1	Resistance Cancellation 2	0	Channel 2 Resistance Cancellation Enable Bit. Set this bit to logic 1 to enable resistance cancellation. Set this bit to logic 0 to disable resistance cancellation.
0	Resistance Cancellation 1	0	Channel 1 Resistance Cancellation Enable Bit. Set this bit to logic 1 to enable resistance cancellation. Set this bit to logic 0 to disable resistance cancellation.

X = Don't care.

**Offset and Offset Select Registers
(4Dh and 4Eh)**

To compensate for remote temperature reporting errors due to issues with the board layout, the Offset register (4Dh) and Offset Enable register (4Eh) allow for a two's-complement value to be added to the final ADC conversion output. The Offset register (4Dh) contains the value for the shared temperature offset (i.e., the same offset is applied to all selected remote channels) and has a programmable ±31.75°C range.

The Offset Enable register (4Eh) allows the offset to be selectively enabled for each remote channel.

If EXTRANGE = 0, the minimum digital output values are clamped at 00h (0°C), regardless of any applied offset. If EXTRANGE = 1, the maximum digital output values are clamped at FFh (+191°C), regardless of any applied offset.

Table 13. Offset Register (4Dh)

BIT	NAME	POR STATE	FUNCTION
7 (MSB)	SIGN	0	Digital Offset Polarity
6	16°C	0	Digital Offset (Weighted)
5	8°C	0	Digital Offset (Weighted)
4	4°C	0	Digital Offset (Weighted)
3	2°C	0	Digital Offset (Weighted)
2	1°C	0	Digital Offset (Weighted)
1	0.5°C	0	Digital Offset (Weighted)
0	0.25°C	0	Digital Offset (Weighted)

Table 14. Offset Select Register (4Eh)

BIT	NAME	POR STATE	FUNCTION
7 (MSB)	X	0	—
6	Channel 7	0	Remote 7 Offset Enable
5	Channel 6	0	Remote 6 Offset Enable
4	Channel 5	0	Remote 5 Offset Enable
3	Channel 4	0	Remote 4 Offset Enable
2	Channel 3	0	Remote 3 Offset Enable
1	Channel 2	0	Remote 2 Offset Enable
0	Channel 1	0	Remote 1 Offset Enable

Applications Information

Remote-Diode Selection

The MAX6581 directly measures the die temperature of CPUs and other ICs that have on-chip temperature-sensing diodes (see the *Typical Application Circuit*), or it can measure the temperature of a discrete diode-connected transistor.

Discrete Remote Diodes

When the remote-sensing diode is a discrete transistor, its collector and base must be connected together. Table 13 lists examples of discrete transistors that are appropriate for use with the MAX6581. The transistor must be a small-signal type with a relatively high forward voltage; otherwise, the A/D input-voltage range can be violated. The forward voltage at the highest expected temperature must be greater than 0.25V at 10μA, and at the lowest expected temperature the forward voltage must be less than 0.95V at 100μA. Large power transistors must not be used. Also, ensure that the base resistance is less than 100Ω. Tight specifications for forward-current gain (e.g., $50 < \beta < 150$) indicate that the manufacturer has good process controls and that the devices have consistent

V_{BE} characteristics. Manufacturers of discrete transistors do not normally specify or guarantee ideality factor. This normally is not a problem since good-quality discrete transistors tend to have ideality factors that fall within a relatively narrow range. Variations in remote temperature readings of less than ±2°C with a variety of discrete transistors have been observed. However, it is good design practice to verify good consistency of temperature readings with several discrete transistors from any supplier under consideration.

Unused Diode Channels

If one or more of the remote-diode channels is not needed, disconnect the DXP_ and DXN_ inputs for that channel, or connect the DXP_ to the corresponding DXN_. The status register indicates a diode “fault” for this channel and the channel is ignored during the temperature-measurement sequence. It is also good practice to mask any unused channels immediately upon power-up by setting the appropriate bits in the $\overline{\text{ALERT}}$ Mask and $\overline{\text{OVERT}}$ Mask registers.

Table 15. Remote Sensors Transistor Suppliers (for Channels 1–7)

SUPPLIER	MODEL NO.	
	PNP	NPN
Central Semiconductor Corp. (USA)	CMPT3906 2N3906	CMPT3904 2N3904
Fairchild Semiconductor (USA)	MMBT3906 2N3906	2N3904
Infineon (Germany)	SMBT3906	—
ON Semiconductor (USA)	MMBT3906 2N3906	2N3904
ROHM Semiconductor (USA)	SST3906	SST3904
Samsung (Korea)	KST3906-TF	KST3904-TF
Siemens (Germany)	SMBT3906	SMBT3904
Zetex (England)	FMMT3906CT-ND	FMMT3904CT-ND

Note: Discrete transistors must be diode connected (base shorted to collector).

Thermal Mass and Self-Heating

When sensing local temperature, the MAX6581 measures the temperature of the PCB to which it is soldered. The leads provide a good thermal path between the PCB traces and the die. As with all IC temperature sensors, thermal conductivity between the die and the ambient air is poor by comparison, making air-temperature measurements impractical. Since the thermal mass of the PCB is far greater than that of the MAX6581, the device follows temperature changes on the PCB with little or no perceivable delay. When measuring the temperature of a CPU, or other IC with an on-chip sense junction, thermal mass has virtually no effect; the measured temperature of the junction tracks the actual temperature within a conversion cycle. When measuring temperature with discrete remote transistors, the best thermal-response times are obtained with transistors in small packages (i.e., SOT23 or SC70). Take care to account for thermal gradients between the heat source and the sensor, and ensure that stray air currents across the sensor package do not interfere with measurement accuracy. Self-heating does not significantly affect measurement accuracy. Remote-sensor self-heating due to the diode current source is negligible.

ADC Noise Filtering

The integrating ADC has good noise rejection for low-frequency signals, such as power-supply hum. In environments with significant high-frequency EMI, connect an external 100pF capacitor between DXP_ and DXN_. Larger capacitor values can be used for added filtering; however, it can introduce errors due to the rise time of the switched current source. High-frequency noise reduction is needed for high-accuracy remote measurements. Noise can be reduced with careful PCB layout as discussed in the *PCB Layout* section.

Slave Address

The slave address for the MAX6581 is shown in Table 16.

Table 16. Slave Address

DEVICE ADDRESS							
A7	A6	A5	A4	A3	A2	A1	A0
1	0	0	1	1	0	1	R/W
1	0	0	1	1	1	0	R/W
1	0	0	1	1	1	1	R/W
1	0	0	1	1	0	0	R/W

PCB Layout

Follow the guidelines below to reduce the measurement error when measuring remote temperature:

- 1) Place the MAX6581 as close as possible to the remote diode. In noisy environments, such as a computer motherboard, this distance is typically 4in to 8in. This length can be increased if the worst-noise sources are avoided. Noise sources include displays, clock generators, memory buses, and PCI buses.
- 2) Do not route the DXP_–DXN_ lines next to the deflection coils of a CRT. Also, do not route the traces across fast digital signals, which can easily introduce +30°C error, even with good filtering.
- 3) Route the DXP_ and DXN_ traces in parallel and in close proximity to each other. Each parallel pair of traces should go to a remote diode. Route these traces away from any higher voltage traces, such as +12V DC. Leakage currents from PCB contamination must be dealt with carefully since a 20MΩ leakage path from DXP_ to ground causes approximately +1°C error. If high-voltage traces are unavoidable, connect guard traces to GND on either side of the DXP_–DXN_ traces (Figure 5).
- 4) Route through as few vias and crossunders as possible to minimize copper/solder thermocouple effects.
- 5) Use wide traces when possible (5-mil to 10-mil traces are typical). Be aware of the effect of trace resistance on temperature readings when using long, narrow traces.
- 6) When the power supply is noisy, add a resistor (up to 47Ω) in series with V_{CC}.

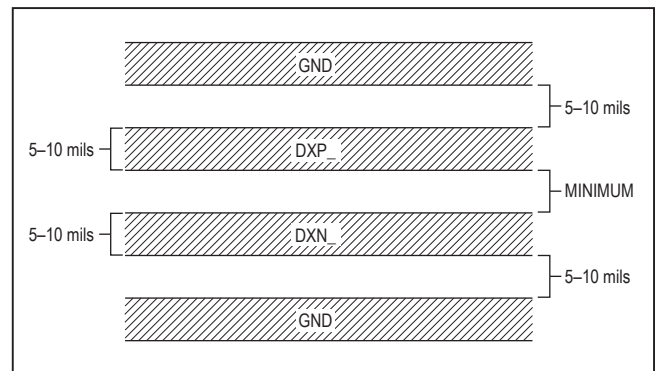

Figure 5. Recommended DXP_–DXN_ PCB Traces. The two outer guard traces are recommended if high-voltage traces are near the DXN_ and DXP_ traces.

Twisted-Pair and Shielded Cables

Use a twisted-pair cable to connect the remote sensor for remote-sensor distances longer than 8in or in very noisy environments. Twisted-pair cable lengths can be between 6ft and 12ft before noise introduces excessive errors. For longer distances, the best solution is a shielded twisted pair such as those used for audio microphones. For example, Belden #8451 works well for distances up to 100ft in a noisy environment. At the device, connect the

twisted-pair cables to DXP_ and DXN_ and the shielded cable to GND. Leave the shielded cable unconnected at the remote sensor. For very long cable runs, the cable's parasitic capacitance often provides noise filtering; therefore the 100pF capacitor can often be removed or reduced in value. Cable resistance also affects remote-sensor accuracy. For every 1Ω of series resistance, the error is approximately +0.5°C.

Typical Application Circuit

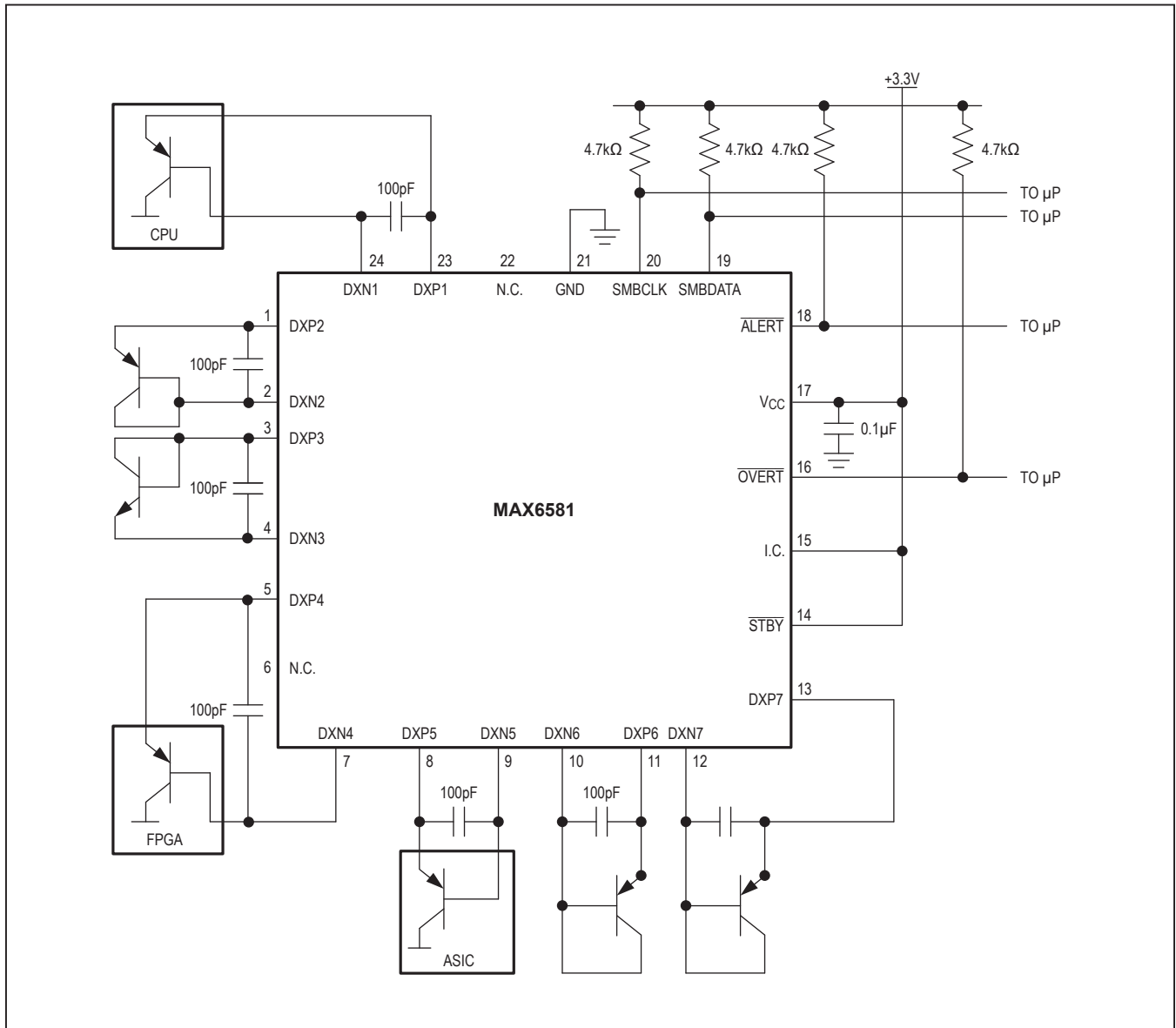

Chip Information

PROCESS: BICMOS

Package Information

For the latest package outline information and land patterns (footprints), go to www.maximintegrated.com/packages. Note that a "+", "#", or "-" in the package code indicates RoHS status only. Package drawings may show a different suffix character, but the drawing pertains to the package regardless of RoHS status.

PACKAGE TYPE	PACKAGE CODE	OUTLINE NO.	LAND PATTERN NO.
24 TQFN-EP	T2444+4	21-0139	90-0022

Revision History

REVISION NUMBER	REVISION DATE	DESCRIPTION	PAGES CHANGED
0	8/10	Initial release	—
1	2/13	Added the Package <i>Thermal Characteristics</i> section; updated Table 1; added 58h register to Table 3; added the <i>Offset and Offset Select Registers (4Dh and 4Eh)</i> section and related bit tables	2, 12, 14, 22
2	2/17	Updated <i>Unused Diode Channels</i> section	23
3	4/17	Updated Table 1	12
4	2/19	Updated <i>OVERT Mask Register (43h)</i> section, Table 6, and Table 8	15, 16, 18
5	4/21	Updated <i>Ordering Information</i> table and Table 16	1, 24



Information furnished by Analog Devices is believed to be accurate and reliable. However, no responsibility is assumed by Analog Devices for its use, nor for any infringements of patents or other rights of third parties that may result from its use. Specifications subject to change without notice. No license is granted by implication or otherwise under any patent or patent rights of Analog Devices. Trademarks and registered trademarks are the property of their respective owners.

X-ON Electronics

Largest Supplier of Electrical and Electronic Components

Click to view similar products for [Board Mount Temperature Sensors](#) category:

Click to view products by [Maxim](#) manufacturer:

Other Similar products are found below :

[5962-8757102XA](#) [66F115](#) [EMC1063-1-ACZL-TR](#) [NCT218FCT2G](#) [O53GAB175A-160Y](#) [3610085020002](#) [389049M9527](#) [MIKROE-912](#)
[ADM1023ARQZ-REEL](#) [ADM1032ARMZ-1RL](#) [AT30TS74-U1FMBB-T](#) [AT30TS74-U1FMAB-T](#) [AT30TS74-U1FMCB-T](#) [AT30TS74-](#)
[U1FMDB-T](#) [ADT7483AARQZ-RL](#) [ADT7481ARMZ-REEL](#) [ADT7463ARQZ-REEL](#) [MCP98243T-BE/MC](#) [66L080-0226](#) [5962-8757103XA](#)
[S-58LM20A-I4T1U](#) [NCT375MNR2G](#) [LM84CIMQA](#) [CAT34TS00VP2GT4A](#) [NCT80DBR2G](#) [SEN-16304](#) [GX21M15](#) [GX122](#) [NST175H-](#)
[QSPR](#) [TC6501P065VCTTR](#) [AT-1U](#) [MCP9700AT-E/LT](#) [MCP9701-E/TO](#) [MCP9803-M/MS](#) [MCP9701A-E/TO](#) [LM57FEPWQ1](#) [LM57FPW](#)
[LM57FSPWQ1](#) [60-41123102-0150.0010](#) [60-43123102-0150.0010](#) [60-53123102-0150.0010](#) [MLX90615SSG-DAA-000-TU](#) [TMP303CDRLR](#)
[TC6501P055VCTTR](#) [TC6503P005VCTTR](#) [ADT7311WTRZ-RL](#) [ADT7311WTRZ-RL7](#) [ADT7473ARQZ-REEL](#) [LM335AM](#)
[LM335AM/NOPB](#)