

General Description

The MAX66240 evaluation kit (EV kit) reference board is a ready-to-use PCB that showcases one of Maxim's MAX662xx family of secure HF ICs. The board is built with a hexagonal-shaped antenna construction (see the *EV Kit Photo* and [Figure 3](#)) tuned to 13.56MHz.

The EV kit is a platform that allows designers, test, and systems engineers to evaluate our MAX66240 tag solution. The EV kit allows users to evaluate the performance and capabilities of certain key features of the part and is a great platform to get started on a new NFC/RFID tag design.

Features and Benefits

- HF Interface at 13.56MHz
- User EEPROM Authenticated Memory Page Read/Write Transactions
- User EEPROM Page/Block Read/Write Transactions
- Secure Transaction that Writes “Secret Keys” and Computes Message Authentication Code

EV Kit Contents

- MAX66240 EV Kit Motherboard

[Ordering Information](#) appears at end of data sheet.

EV Kit Photo

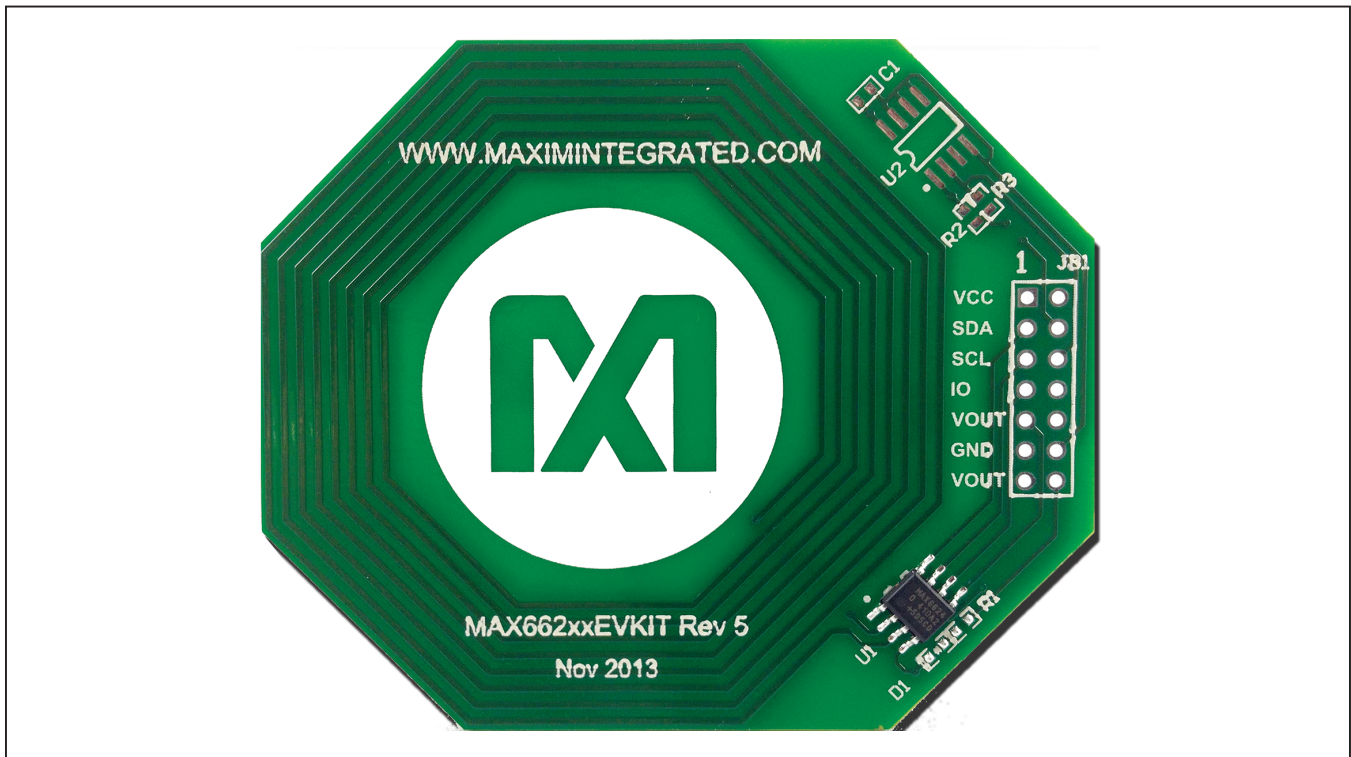

Quick Start

Android Demo Application

The Android demo application supports multiple MAX662xx EV kit boards. This demo application provides a quick path to demonstrating the features of both the MAX66240 and the MAX66242. To run the demo, the application should be downloaded to an Android-based NFC smartphone or tablet.

How to Download Android Application from Android Market (a.k.a. Google Play Store)

The demo application is available to download free of charge from Google's Play Store (Figure 1). To find the application, search for the **MAX662XX SHA256** icon. Click and press the **Install** button to download and install the application. You will then be ready to exercise the demo board. Figure 2 shows the application's icon.



Figure 1. Google Play Icon

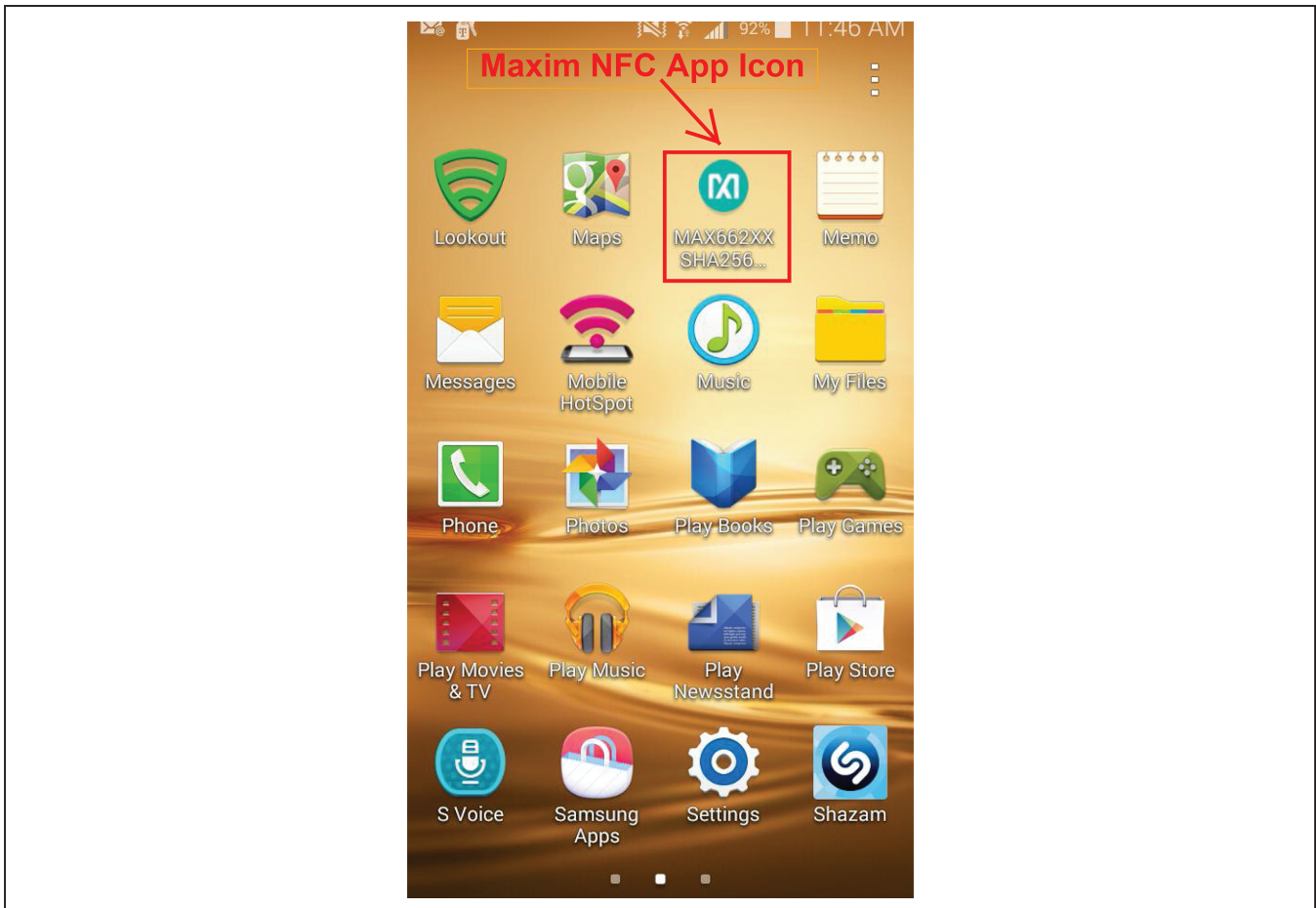

Figure 2. Android Application Screenshots

Users who are using their handsets while connected directly to their PC or notebook computer can use the link below to access the application. The user should keep in mind that NFC communications will need to be enabled on the phone or tablet for the application to be loaded successfully, and/or function properly.

<https://play.google.com/store/search?q=MAX662XX%20Sha256&c=apps&hl=en>

EV Kit Setup

The EV kit requires no jumpers to run the MAX66240 features. With the Android application already downloaded on the NFC-enabled phone or tablet, the user has everything needed to run the demo.

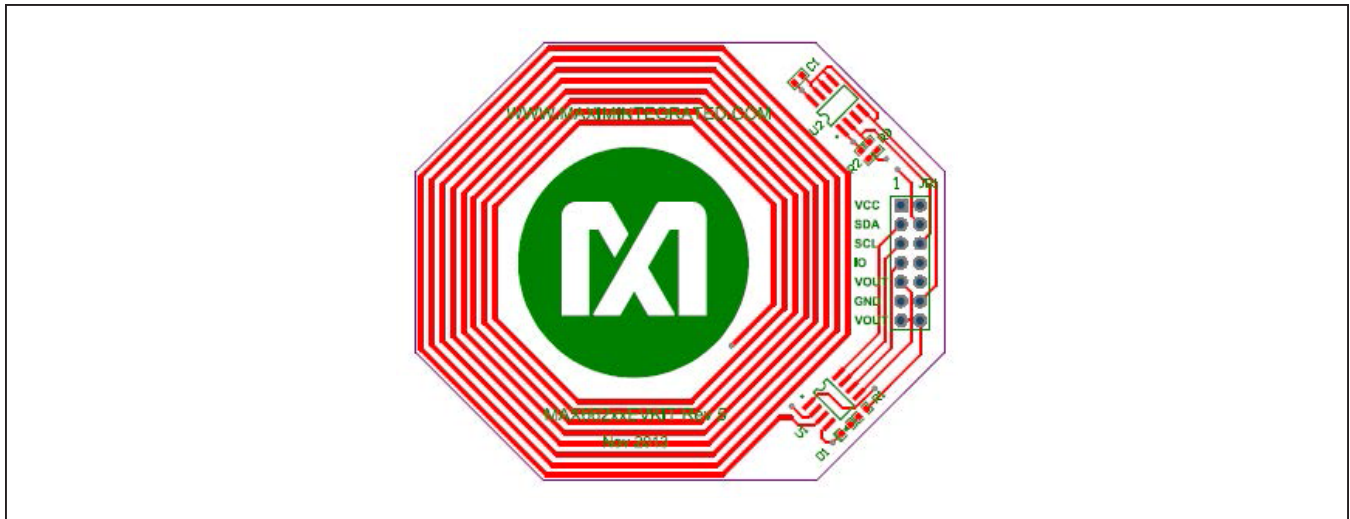

Figure 3. MAX662xx Antenna Layout

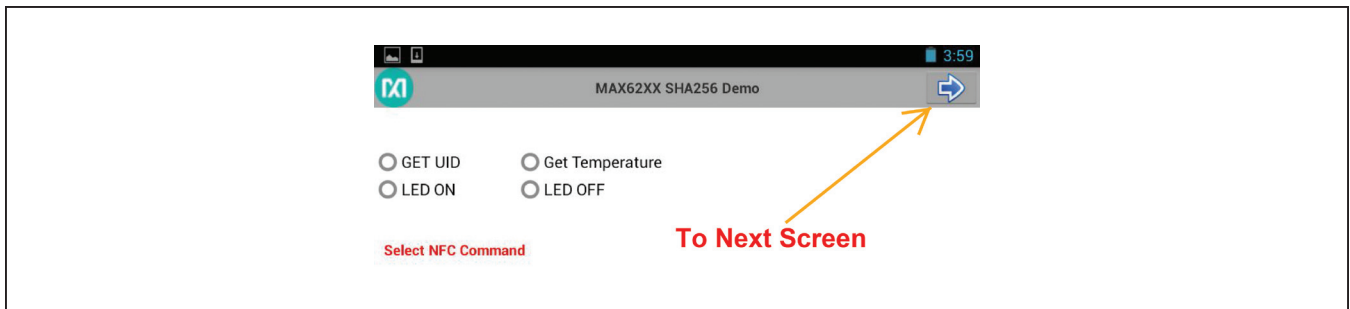

Figure 4a. Application Menu with Landing Screen

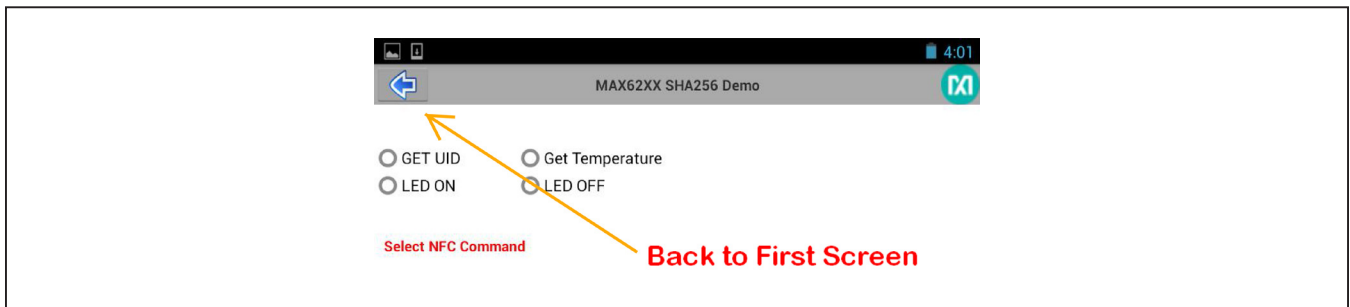

Figure 4b. Next Screen

Running the Demo

MAX662xx SHA2 Android Application

The MAX662XX SHA2 Android application supports several functions on the EV kit. These include reading tag UID, reading/writing data into tag user memory (ASCII data entry for block-write is not supported with this version), performing authenticated writes, and computing/comparing message authentication codes (MAC), among others.

The user only needs to make a selection from the menu and bring the tag/EV kit into the vicinity of the phone or tablet. It helps to know where the NFC antenna on the phone or tablet is located. The user can get an idea as to where the antenna is located by doing several UID reads while touching the EV kit at several locations on the phone or tablet. On many phones, the antenna is located on the upper half of the backside of the phone.

Reading UID

Select the menu item **Get UID** (Figure 5) and bring the EV kit into the vicinity of the phone/tablet.

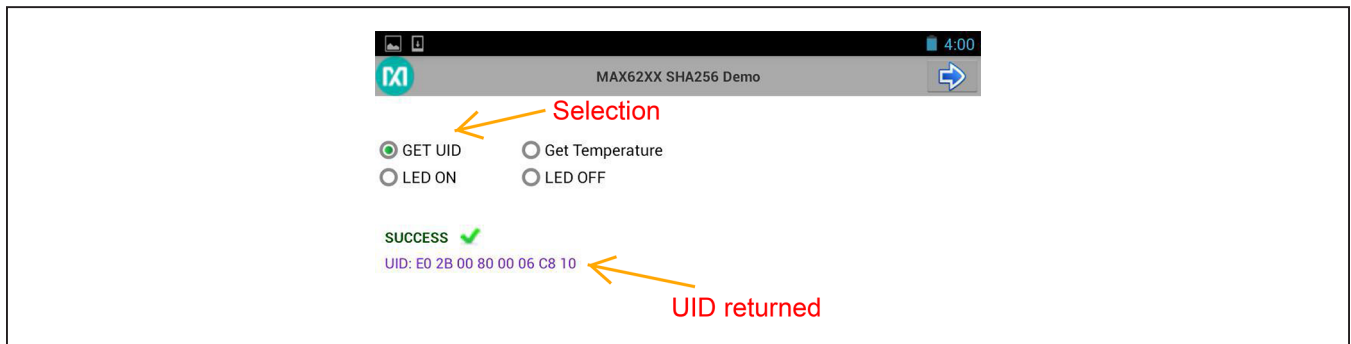

Figure 5. Reading Tag UID

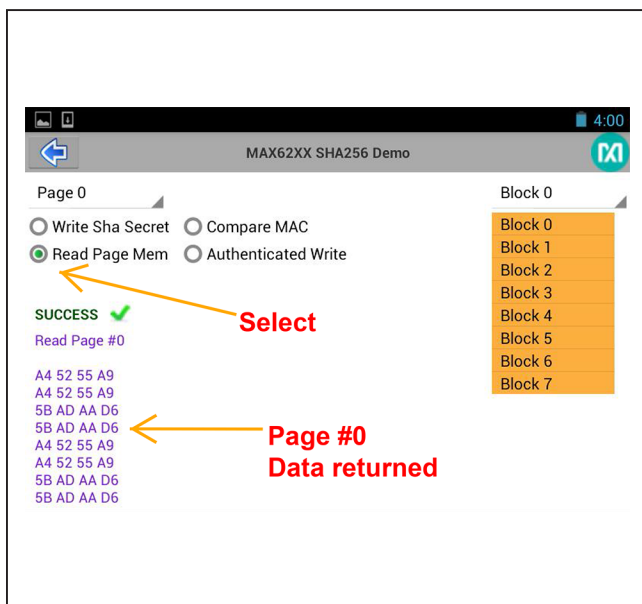

Figure 6a. Reading Tag Memory

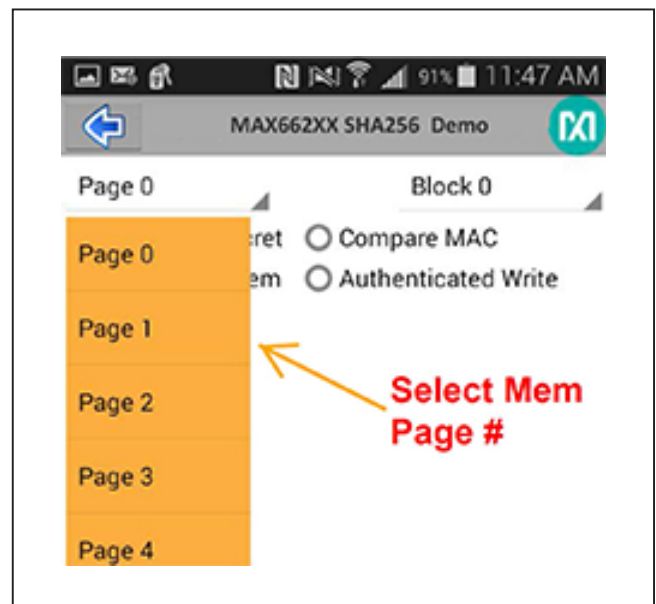

Figure 6b. Selecting Tag Memory

Reading Memory Page

Select the menu item to read memory and a specific block to read (Figure 6a). The MAX66240 has a 4Kb memory, organized as pages. Touch the Page 0 menu item (Figure 6b) to get a drop box. After the specific page number selection, bring the EV kit into the vicinity of the phone/tablet.

Loading a SHA-2 Secret and Performing a MAC Compare

Select the menu item and bring the EV kit into the vicinity of the phone/tablet.

The MAX66xxx represents a family of products. The features covered are shown in Figure 7a and Figure 7b.

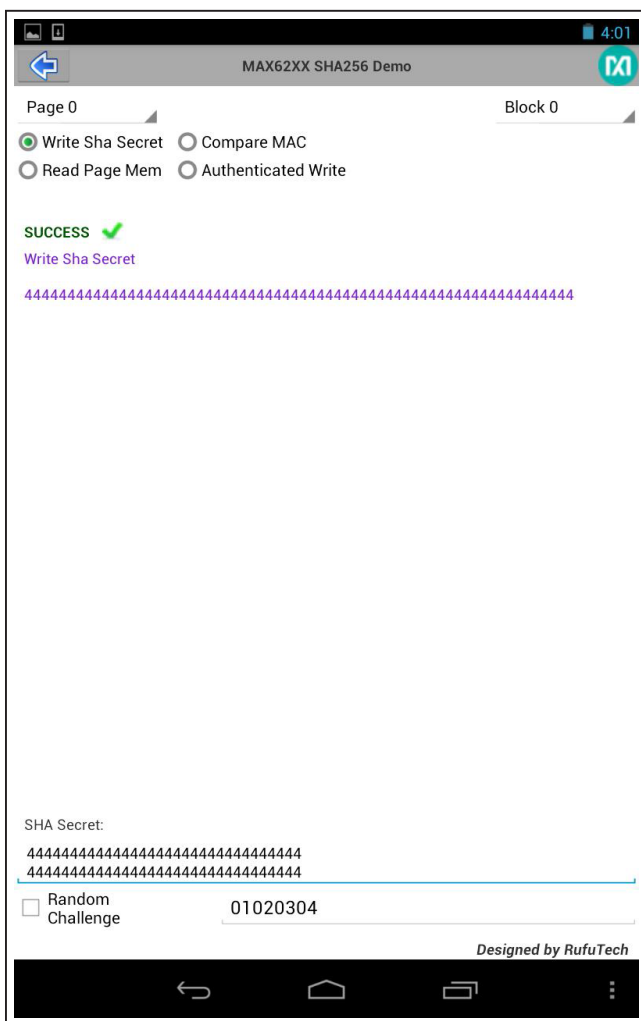

Figure 7a. Writing a SHA-256 Secret

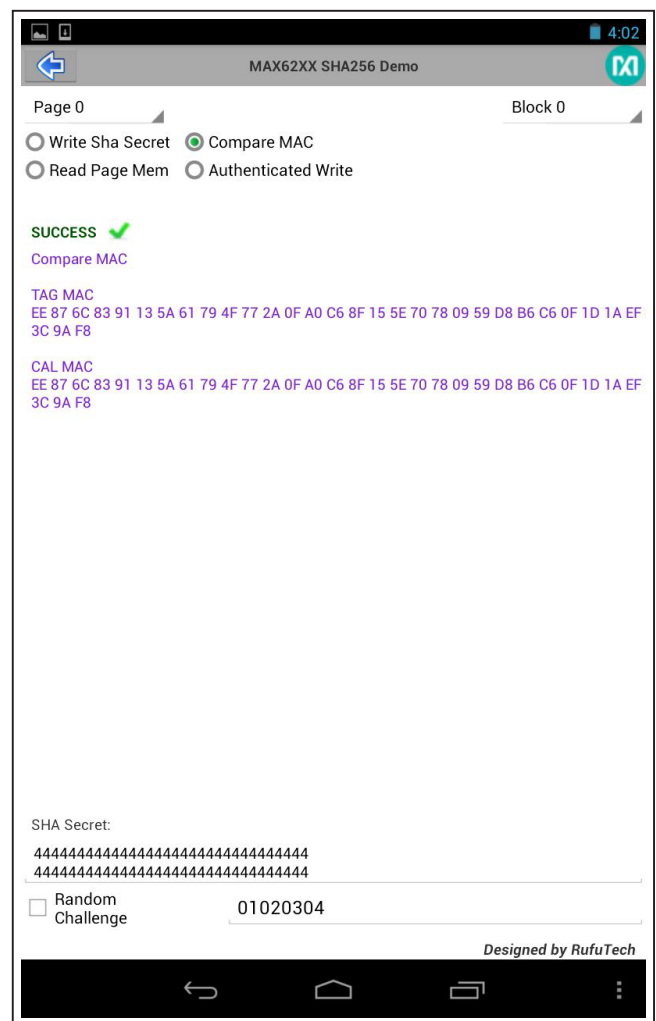

Figure 7b. Doing a MAC Compare

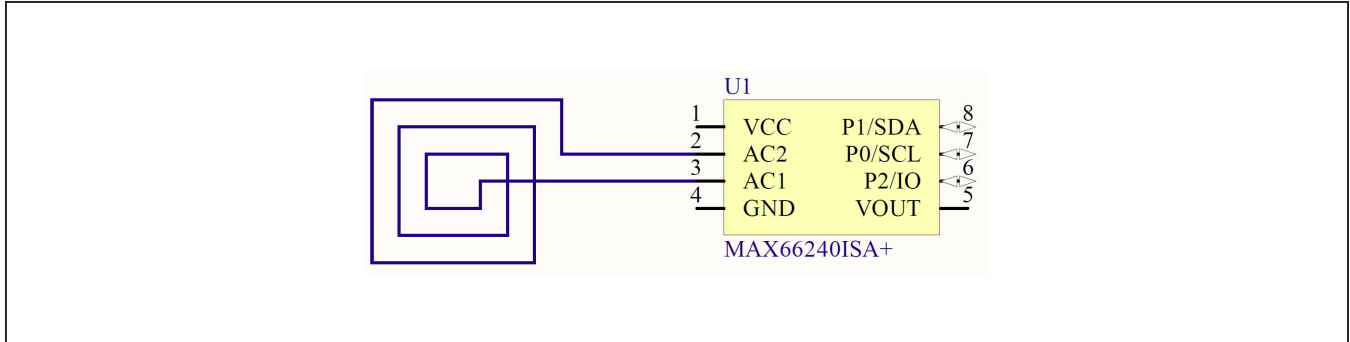

Figure 8. MAX66240 EV Kit Schematic

Component List

DESIGNATION	QTY	DESCRIPTION
C1	0	Not populated, ceramic capacitor
D1	0	Not populated, diode
JB1	0	Not populated
R1–R3	0	Not populated, resistors
U1	1	ISO 15693, SHA-256, and 4Kb user EEPROM Maxim MAX66240ISA+ (8 SO)

DESIGNATION	QTY	DESCRIPTION
U2	0	Not populated
—	1	PCB#: Assembled for MAX66240#K00 Kit

Ordering Information

PART	TYPE
MAX66240EVKIT#	EV Kit

#Denotes RoHS compliant.

Revision History

REVISION NUMBER	REVISION DATE	DESCRIPTION	PAGES CHANGED
0	10/14	Initial release	—

For more information, please contact Maxim customer Apps support at: https://support.maximintegrated.com/tech_support/submit_question.mvp?pl_id=21.

For pricing, delivery, and ordering information, please contact Maxim Direct at 1-888-629-4642, or visit Maxim Integrated's website at www.maximintegrated.com.

Maxim Integrated cannot assume responsibility for use of any circuitry other than circuitry entirely embodied in a Maxim Integrated product. No circuit patent licenses are implied. Maxim Integrated reserves the right to change the circuitry and specifications without notice at any time.

X-ON Electronics

Largest Supplier of Electrical and Electronic Components

Click to view similar products for [Security/Authentication Development Tools](#) category:

Click to view products by [Maxim](#) manufacturer:

Other Similar products are found below :

[MAXREFDES132#](#) [IPL-003WR](#) [AT88CK460WHITE](#) [ATCRYPTOAUTH-XPRO](#) [BLOCKCHAINSTARTKITTOBO1](#) [DS28C40EVKIT#](#)
[MAXREFDES143#](#) [AT88CK590](#) [AT88CKECC-AWS-XSTK-B](#) [ATCRYPTOAUTH-XPRO-B](#) [DM320109](#) [DM320118](#) [DT100104](#)
[MIKROE-3746](#) [MIKROE-3774](#) [MIKROE-3915](#) [MIKROE-4236](#) [MIKROE-1819](#) [MIKROE-2829](#) [MIKROE-3045](#) [OM-SE050ARD](#)
[102010288](#) [AT97SC3205P-SDK2](#) [MAXREFDES34#](#) [AT88CKECC-AWS-XSTK](#) [MIKROE-2761](#) [MAXREFDES155#](#) [MIKROE-2760](#)
[MIKROE-2522](#) [MIKROE-2733](#) [cs-pastilda-01](#) [CS-SOMU-02](#) [103030395](#)