



±1°C Fail-Safe Remote/Local Temperature Sensors with SMBus Interface

MAX6680/MAX6681

General Description

The MAX6680/MAX6681 are precise, two-channel digital thermometers. Each accurately measures the temperature of its own die and one remote PN junction and reports the temperature on a 2-wire serial interface. The remote junction can be a diode-connected transistor like the low-cost NPN type 2N3904 or PNP type 2N3906. The remote junction can also be a common-collector PNP, such as a substrate PNP of a microprocessor.

The MAX6680/MAX6681 include pin-programmable default temperature thresholds for the $\overline{\text{OVERT}}$ output, which provides fail-safe clock throttling or system shutdown. In addition, the devices are pin programmable to select whether the $\overline{\text{OVERT}}$ output responds to either the local, remote, or both temperatures.

The 2-wire serial interface accepts standard System Management Bus (SMBus)[™] commands such as Write Byte, Read Byte, Send Byte, and Receive Byte to read the temperature data and program the alarm thresholds and conversion rate. The MAX6680/MAX6681 can function autonomously with a programmable conversion rate, which allows the control of supply current and temperature update rate to match system needs. For conversion rates of 4Hz or less, the remote sensor temperature can be represented in extended mode as 10 bits + sign with a resolution of 0.125°C. When the conversion rate is 8Hz, output data is 7 bits + sign with a resolution of 1°C. The MAX6680/MAX6681 also include an SMBus timeout feature to enhance system reliability.

The MAX6681 is an upgrade to the MAX6654. The MAX6680/MAX6681 remote accuracy is ±1°C with no calibration needed. They are available in a 16-pin QSOP package and operate throughout the -55°C to +125°C temperature range.

Applications

Desktop Computers
Notebook Computers
Servers
Thin Clients
Workstations

Pin Configurations appear at end of data sheet.

SMBus is a trademark of Intel Corp.

I²C is a trademark of Philips Corp.

Features

- ◆ Two Alarm Outputs: $\overline{\text{ALERT}}$ and $\overline{\text{OVERT}}$
- ◆ Pin-Programmable Threshold for $\overline{\text{OVERT}}$ Limit
- ◆ Programmable Under/Overttemperature $\overline{\text{ALERT}}$ Limit
- ◆ Dual Channel: Measures Remote and Local Temperature
- ◆ 11-Bit, 0.125°C Resolution for Remote Temperature Measurements
- ◆ High Accuracy ±1°C (max) from +60°C to +100°C (Remote)
- ◆ No Calibration Required
- ◆ SMBus/I²C[™]-Compatible Interface
- ◆ SMBus Timeout Prevents SMBus Lockup

Ordering Information

PART	TEMP RANGE	PIN-PACKAGE
MAX6680MEE	-55°C to +125°C	16 QSOP
MAX6681MEE	-55°C to +125°C	16 QSOP

Typical Operating Circuit

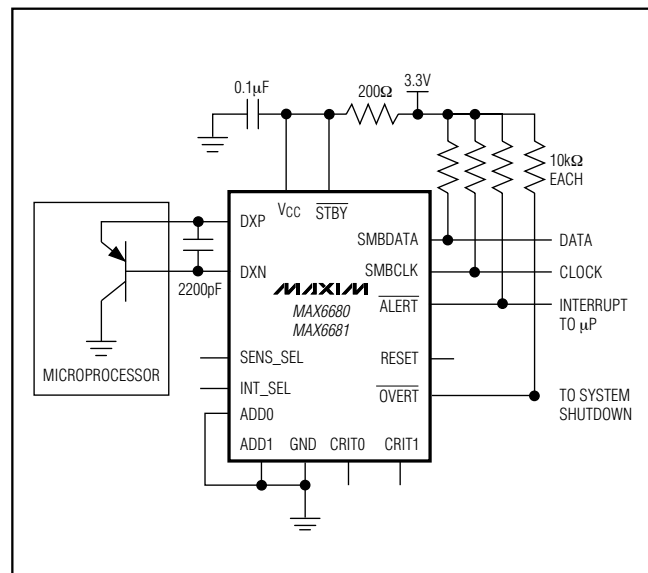

±1°C Fail-Safe Remote/Local Temperature Sensors with SMBus Interface

ABSOLUTE MAXIMUM RATINGS

V_{CC}-0.3V to +6V
 DXP-0.3V to (V_{CC} + 0.3V)
 DXN-0.3V to +0.8V
 SMBCLK, SMBDATA, ALERT, OVERT-0.3V to +6V
 RESET, INT_SEL, STBY, ADD0, ADD1-0.3V to +6V
 CRIT1, CRIT0, SENS_SEL-0.3V to +6V
 SMBDATA, ALERT, OVERT, Current-1mA to +50mA
 DXN Current±1mA

Continuous Power Dissipation (T_A = +70°C)
 16-Pin QSOP (derate 8.3mW/°C above +70°C)664mW
 Junction Temperature+150°C
 Storage Temperature Range-65°C to +150°C
 Lead Temperature (soldering, 10s)+300°C

Stresses beyond those listed under "Absolute Maximum Ratings" may cause permanent damage to the device. These are stress ratings only, and functional operation of the device at these or any other conditions beyond those indicated in the operational sections of the specifications is not implied. Exposure to absolute maximum rating conditions for extended periods may affect device reliability.

ELECTRICAL CHARACTERISTICS

(Circuit of Typical Operating Circuit, V_{CC} = 3.0V to 5.5V, T_A = -25°C to +125°C, unless otherwise specified. Typical values are at V_{CC} = 3.3V and T_A = +25°C.)

PARAMETER	SYMBOL	CONDITIONS	MIN	TYP	MAX	UNITS
Temperature Resolution, Legacy Mode			1			°C
			8			Bits
Temperature Resolution, Extended Mode			0.125			°C
			11			Bits
Remote Temperature Error (Note 1)		T _{RJ} = +60°C to +100°C, V _{CC} = 3.3V	-1.0		+1.0	°C
		T _{RJ} = +50°C to +120°C, V _{CC} = 3.3V	-2.0		+2.0	
		T _{RJ} = -55°C to +125°C, V _{CC} = 3.3V	-3.0		+3.0	
Local Temperature Error		T _A = +60°C to +100°C, V _{CC} = 3.3V	-1.5		+1.5	°C
		T _A = 0°C to +125°C, V _{CC} = 3.3V	-3.0		+3.0	
		T _A = -55°C to +125°C, V _{CC} = 3.3V (Note 2)	-5.0		+5.0	
Line Regulation		3.0V ≤ V _{CC} ≤ 5.5V		0.2	0.6	m°C/V
Supply Voltage Range	V _{CC}		3.0		5.5	V
Undervoltage Lockout Threshold	UVLO	Falling edge of V _{CC} disables ADC	2.60	2.80	2.95	V
Undervoltage Lockout Hysteresis				90		mV
Power-On Reset (POR) Threshold		V _{CC} , falling edge	1.5	2.0	2.5	V
POR Threshold Hysteresis				90		mV
Conversion Time		Legacy		62.5		ms
		Extended		125		
Standby Supply Current		SMBus static		3	10	μA
Operating Current		During conversion		0.55	1.0	mA
Average Operating Current (Note 3)		0.25 conversions/s		35	70	μA
		2 conversions/s		120	180	
DXP and DXN Leakage Current		In standby mode			2	μA
Remote-Diode Source Current	I _{RJ}	High level	80	100	120	μA
		Low level	8	10	12	

±1°C Fail-Safe Remote/Local Temperature Sensors with SMBus Interface

MAX6680/MAX6681

ELECTRICAL CHARACTERISTICS (continued)

(Circuit of Typical Operating Circuit, $V_{CC} = 3.0V$ to $5.5V$, $T_A = -25^{\circ}C$ to $+125^{\circ}C$, unless otherwise specified. Typical values are at $V_{CC} = 3.3V$ and $T_A = +25^{\circ}C$.)

PARAMETER	SYMBOL	CONDITIONS	MIN	TYP	MAX	UNITS
CRIT0, CRIT1, ADD0, ADD1, RESET, INT_SEL, SENS_SEL						
Logic Input Low Voltage	V_{IL}				0.8	V
Logic Input High Voltage	V_{IH}		2.4			V
Input Leakage Current	I_{LEAK}		-1		+1	μA
(ALERT, OVERT)						
Output Low Sink Current		$V_{OL} = 0.4V$			1	mA
Output High Leakage Current		$V_{OH} = 5.5V$			1	μA
SMBus INTERFACE (SMBCLK, SMBDATA, STBY)						
Logic Input Low Voltage	V_{IL}				0.8	V
Logic Input High Voltage	V_{IH}	$V_{CC} = 3.0V$	2.2			V
		$V_{CC} = 5.5V$	2.4			
Input Leakage Current	I_{LEAK}	$V_{IN} = GND$ or V_{CC}			± 2	μA
Output Low Sink Current	I_{OL}	$V_{OL} = 0.6V$			6	mA
Input Capacitance	C_{IN}			5		pF
SMBus-COMPATIBLE TIMING (Note 5)						
Serial Clock Frequency (Note 5)	f_{SCL}				100	kHz
Bus Free Time Between STOP and START Condition	t_{BUF}		4.7			μs
START Condition Setup Time			4.7			μs
Repeat START Condition Setup Time	$t_{SU:STA}$	90% to 90%	50			ns
START Condition Hold Time	$t_{HD:STA}$	10% of SMBDATA to 90% of SMBCLK	4			μs
STOP Condition Setup Time	$t_{SU:STO}$	90% of SMDCLK to 90% of SMBDATA	4			μs
Clock Low Period	t_{LOW}	10% to 10%		4.7		μs
Clock High Period	t_{HIGH}	90% to 90%	4			μs
Data Setup Time (Note 6)	$t_{HD:DAT}$		250			ns
Receive SCL/SDA Rise Time	t_R				1	μs
Receive SCL/SDA Fall Time	t_F				300	ns
Pulse Width of Spike Suppressed	t_{SP}		0		50	ns
SMBus Timeout (Note 5)		SMBDATA low period for interface reset	25	37	45	ms

Note 1: $T_A = +25^{\circ}C$ to $+85^{\circ}C$.

Note 2: If both the local and the remote junction are below $T_A = -20^{\circ}C$, then $V_{CC} > 3.15V$.

Note 3: Conversions done in extended mode. For legacy mode, current is approximately half.

Note 4: Timing specifications guaranteed by design.

Note 5: The serial interface resets when SMBCLK or SMBDATA is low for more than $t_{TIMEOUT}$.

Note 6: A transition must internally provide at least a hold time to bridge the undefined region (300ns max) of SMBCLK's falling edge.

$\pm 1^\circ\text{C}$ Fail-Safe Remote/Local Temperature Sensors with SMBus Interface

Typical Operating Characteristics

($T_A = +25^\circ\text{C}$, unless otherwise noted.)

STANDBY SUPPLY CURRENT vs. SUPPLY VOLTAGE

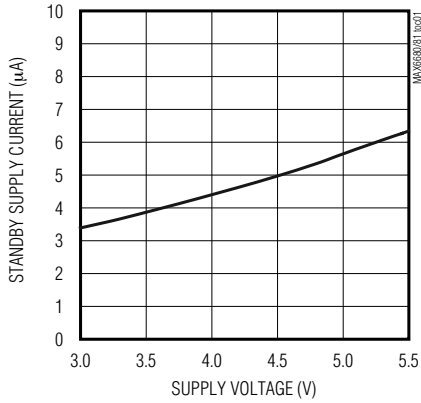

AVERAGE OPERATING SUPPLY CURRENT vs. CONVERSION RATE

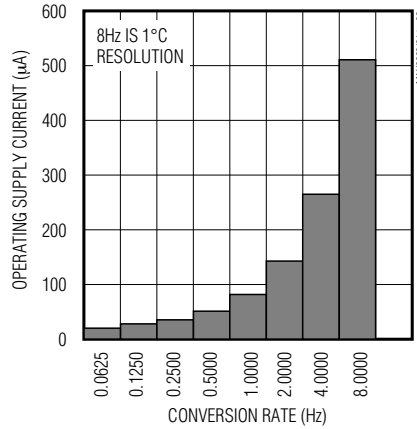

TEMPERATURE ERROR vs. REMOTE-DIODE TEMPERATURE

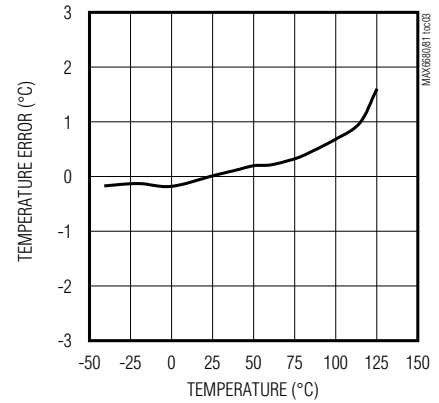

LOCAL TEMPERATURE ERROR vs. DIE TEMPERATURE

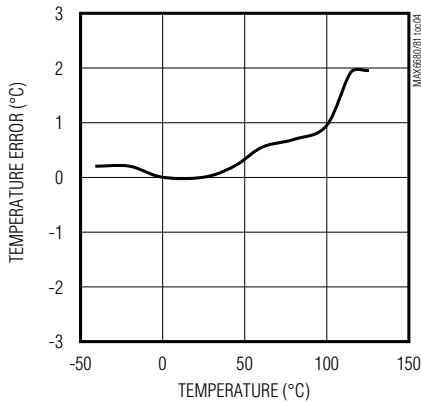

TEMPERATURE ERROR vs. POWER-SUPPLY NOISE FREQUENCY

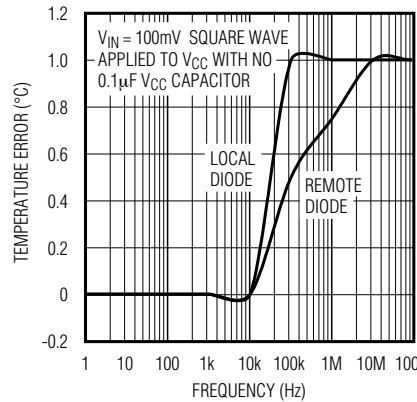

TEMPERATURE ERROR vs. COMMON-MODE NOISE FREQUENCY

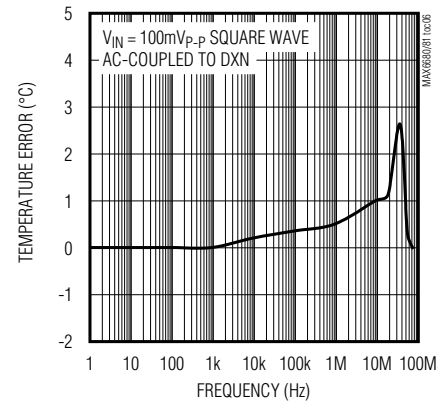

TEMPERATURE ERROR vs. DIFFERENTIAL NOISE FREQUENCY

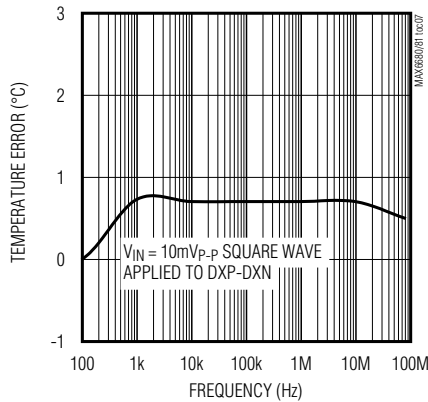

TEMPERATURE ERROR vs. DXP-DXN CAPACITANCE

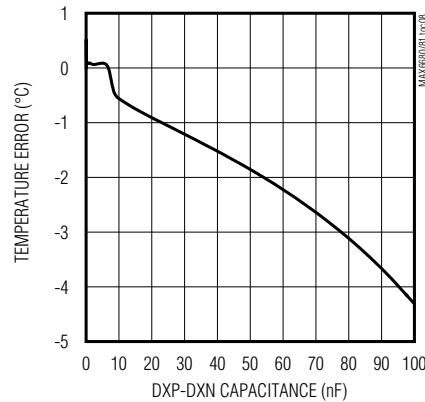

$\pm 1^{\circ}\text{C}$ Fail-Safe Remote/Local Temperature Sensors with SMBus Interface

Pin Description

MAX6680/MAX6681

PIN		NAME	FUNCTION
MAX6680	MAX6681		
1	2	V _{CC}	Supply Voltage Input, 3V to 5.5V. Bypass V _{CC} to GND with a 0.1μF capacitor. A 200Ω series resistor is recommended, but not required for additional noise filtering. See the <i>Typical Operating Circuit</i> .
2, 5	1, 5	CRIT1, CRIT0	Hardware-Programmable Default Alarm Threshold for $\overline{\text{OVERT}}$ Limits. Use Table 4 to set default temperatures.
3	3	DXP	Combined Remote-Diode Current Source and A/D Positive Input for Remote-Diode Channel. DO NOT LEAVE DXP FLOATING; connect DXP to DXN if no remote diode is used. Place a 2200pF capacitor between DXP and DXN for noise filtering.
4	4	DXN	Combined Remote-Diode Current Sink and A/D Negative Input. DXN is internally biased to one diode drop above ground.
6	6	ADD1	SMBus Address Select Pin (Table 9). ADD0 and ADD1 are sampled upon power-up. Excess capacitance (>50pF) at the address pins when floating may cause address-recognition problems.
7	7	RESET	Reset Input. Drive RESET high to set all registers to their default values (POR state). Drive RESET low or leave floating for normal operation.
8	8	GND	Ground
9	9	$\overline{\text{OVERT}}$	Overtemperature Active-Low Output. Open drain.
10	10	ADD0	SMBus Slave Address Select Pin (see ADD1).
11	11	$\overline{\text{ALERT}}$	SMBus Alert (Interrupt) Active-Low Output. Open drain.
12	12	SMBDATA	SMBus Serial-Data Input/Output, Open Drain
13	13	INT_SEL	Input. Connect high or leave floating to conform to the standard SMBus $\overline{\text{ALERT}}$ protocol. See the <i>ALERT Interrupts</i> section. Connect to GND to invoke comparator mode, where $\overline{\text{ALERT}}$ is asserted whenever any of the temperature conditions is violated by the remote sensor. In this mode, $\overline{\text{ALERT}}$ can only be deasserted by the condition returning within the temperature limits by enabling the mask bit in the Configuration register.
14	14	SMBCLK	SMBus Serial-Clock Input
15	15	$\overline{\text{STBY}}$	Input. Hardware Standby. Connect to ground to place in device in standby. Supply current drops below 10μA and all registers' data are maintained.
16	16	SENS_SEL	Input. Selects which temperature sensor (local, remote, or both) activates $\overline{\text{OVERT}}$. High = Remote, Low = Local, Open = Local and Remote

±1°C Fail-Safe Remote/Local Temperature Sensors with SMBus Interface

MAX6680/MAX6681

age and computes the temperature based on this voltage. If the remote channel is not used, connect DXP to DXN. **Do not leave DXP and DXN unconnected.** When a conversion is initiated, both channels are converted whether or not they are used. The DXN input is biased at one V_{BE} above ground by an internal diode to set up the ADC inputs for a differential measurement. Resistance in series with the remote diode causes about 1/2°C error per ohm.

A/D Conversion Sequence

A conversion sequence consists of a local temperature measurement and a remote temperature measurement. Each time a conversion begins, whether initiated automatically in the free-running autoconvert mode (RUN/STOP = 0) or by writing a One-Shot command, both channels are converted, and the results of both measurements are available after the end of conversion. A BUSY status bit in the Status register shows that the device is actually performing a new conversion. The results of the previous conversion sequence are still available when the ADC is busy.

Remote-Diode Selection

The MAX6680/MAX6681 can directly measure the die temperature of CPUs and other ICs that have on-board temperature-sensing diodes (see the *Typical Operating Circuit*) or they can measure the temperature of a discrete diode-connected transistor. The type of remote diode used is set by bit 5 of the Configuration Byte. If bit 5 is set to zero, the remote sensor is a diode-connected transistor, and if bit 5 is set to 1, the remote sensor is a substrate or common-collector PNP transistor. For best accuracy, the discrete transistor should be a small-signal device with its collector and base connected together. Accuracy has been experimentally verified for all of the devices listed in Table 1.

The transistor must be a small-signal type with a relatively high forward voltage; otherwise, the A/D input voltage range can be violated. The forward voltage at the highest expected temperature must be greater than 0.25V at 10μA, and at the lowest expected temperature, forward voltage must be less than 0.95V at 100μA. Large power transistors must not be used. Also, ensure that the base resistance is less than 100Ω. Tight specifications for forward-current gain ($50 < \beta < 150$, for example) indicate that the manufacturer has good process controls and that the devices have consistent V_{BE} characteristics.

Thermal Mass and Self-Heating

When sensing local temperature, these temperature sensors are intended to measure the temperature of the PC board to which they are soldered. The leads pro-

Table 1. Remote-Sensor Transistor Manufacturers

MANUFACTURER	MODEL NO.
Central Semiconductor (USA)	CMPT3904
On Semiconductor (USA)	2N3904, 2N3906
Rohm Semiconductor (USA)	SST3904
Samsung (Korea)	KST3904-TF
Siemens (Germany)	SMBT3904
Zetex (England)	FMMT3904CT-ND

Note: Transistors must be diode connected (base shorted to collector).

vide a good thermal path between the PC board traces and the die. Thermal conductivity between the die and the ambient air is poor by comparison, making air-temperature measurements impractical. Because the thermal mass of the PC board is far greater than that of the MAX6680/MAX6681, the device follows temperature changes on the PC board with little or no perceivable delay.

When measuring the temperature of a CPU or other IC with an on-chip sense junction, thermal mass has virtually no effect; the measured temperature of the junction tracks the actual temperature within a conversion cycle. When measuring temperature with discrete remote sensors, smaller packages (e.g., a SOT23) yield the best thermal response times. Take care to account for thermal gradients between the heat source and the sensor, and ensure that stray air currents across the sensor package do not interfere with measurement accuracy.

Self-heating does not significantly affect measurement accuracy. Remote-sensor self-heating due to the diode current source is negligible. For the local diode, the worst-case error occurs when autoconverting at the fastest rate and simultaneously sinking maximum current at the ALERT output. For example, with $V_{CC} = 5.0V$, an 8Hz conversion rate, and ALERT sinking 1mA, the typical power dissipation is $V_{CC} \times 550\mu A + 0.4V \times 1mA$, which equals 2.75mW; θ_{JA} for the 16-pin QSOP package is about +120°C/W, so assuming no copper PC board heat sinking, the resulting temperature rise is:

$$\Delta T = 2.75mW \times 120^\circ C / W = 0.330^\circ C$$

Even under these engineered circumstances, it is difficult to introduce significant self-heating errors.

ADC Noise Filtering

The integrating ADC used has good noise rejection for low-frequency signals such as 60Hz/120Hz power-sup-

$\pm 1^{\circ}\text{C}$ Fail-Safe Remote/Local Temperature Sensors with SMBus Interface

ply hum. In noisy environments, high-frequency noise reduction is needed for high-accuracy remote measurements. The noise can be reduced with careful PC board layout and proper external noise filtering.

High-frequency EMI is best filtered at DXP and DXN with an external 2200pF capacitor. Larger capacitor values can be used for added filtering, but do not exceed 3300pF because it can introduce errors due to the rise time of the switched current source.

PC Board Layout

Follow these guidelines to reduce the measurement error of the temperature sensors:

- 1) Place the MAX6680/MAX6681 as close as is practical to the remote diode. In noisy environments, such as a computer motherboard, this distance can be 4in to 8in (typ). This length can be increased if the worst noise sources are avoided. Noise sources include CRTs, clock generators, memory buses, and ISA/PCI buses.
- 2) Do not route the DXP-DXN lines next to the deflection coils of a CRT. Also, do not route the traces across fast digital signals, which can easily introduce 30°C error, even with good filtering.
- 3) Route the DXP and DXN traces in parallel and in close proximity to each other, away from any higher voltage traces, such as 12VDC. Leakage currents from PC board contamination must be dealt with carefully since a 20M Ω leakage path from DXP to ground causes about 1°C error. If high-voltage traces are unavoidable, connect guard traces to GND on either side of the DXP-DXN traces (Figure 2).
- 4) Route through as few vias and crossunders as possible to minimize copper/solder thermocouple effects.
- 5) When introducing a thermocouple, make sure that both the DXP and the DXN paths have matching thermocouples. A copper-solder thermocouple exhibits 3 $\mu\text{V}/^{\circ}\text{C}$, and it takes about 200 μV of voltage error at DXP-DXN to cause a 1°C measurement error. Adding a few thermocouples causes a negligible error.
- 6) Use wide traces. Narrow traces are more inductive and tend to pick up radiated noise. The 10mil widths and spacings that are recommended in Figure 2 are not absolutely necessary, as they offer only a minor improvement in leakage and noise over narrow traces. Use wider traces when practical.
- 7) Add a 200 Ω resistor in series with V_{CC} for best noise filtering (see the *Typical Operating Circuit*).

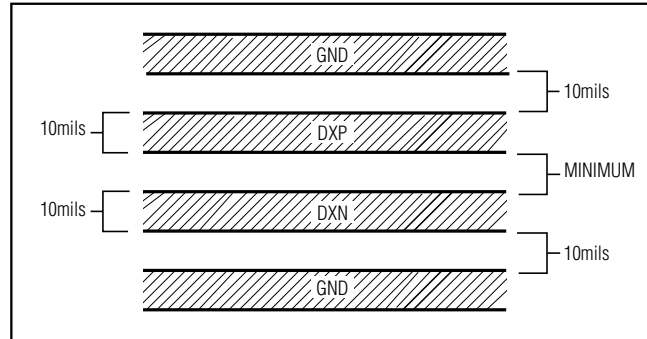

Figure 2. Recommended DXP-DXN PC Traces

Twisted-Pair and Shielded Cables

Use a twisted-pair cable to connect the remote sensor for remote-sensor distances longer than 8in or in very noisy environments. Twisted-pair cable lengths can be between 6ft and 12ft before noise introduces excessive errors. For longer distances, the best solution is a shielded twisted pair like that used for audio microphones. For example, Belden 8451 works well for distances up to 100ft in a noisy environment. At the device, connect the twisted pair to DXP and DXN and the shield to GND. Leave the shield unconnected at the remote sensor.

For very long cable runs, the cable's parasitic capacitance often provides noise filtering, so the 2200pF capacitor can often be removed or reduced in value. Cable resistance also affects remote-sensor accuracy. For every 1 Ω of series resistance, the error is approximately 1/2°C error.

Low-Power Standby Mode

Standby mode reduces the supply current to less than 10 μA by disabling the ADC. Enter hardware standby by forcing the $\overline{\text{STBY}}$ pin low, or enter software standby by setting the RUN/STOP bit to 1 in the Configuration Byte register. Hardware and software standbys are very similar: all data is retained in memory, and the SMB interface is alive and listening for SMBus commands, but the SMBus timeout is disabled. The only difference is that in software standby mode, the One-Shot command initiates a conversion. With hardware standby, the One-Shot command is ignored. Activity on the SMBus causes the device to draw extra supply current (see the *Typical Operating Characteristics*).

Driving the $\overline{\text{STBY}}$ pin low overrides any software conversion command. If a hardware or software standby command is received while a conversion is in progress, the conversion cycle is interrupted, and the tempera-

±1°C Fail-Safe Remote/Local Temperature Sensors with SMBus Interface

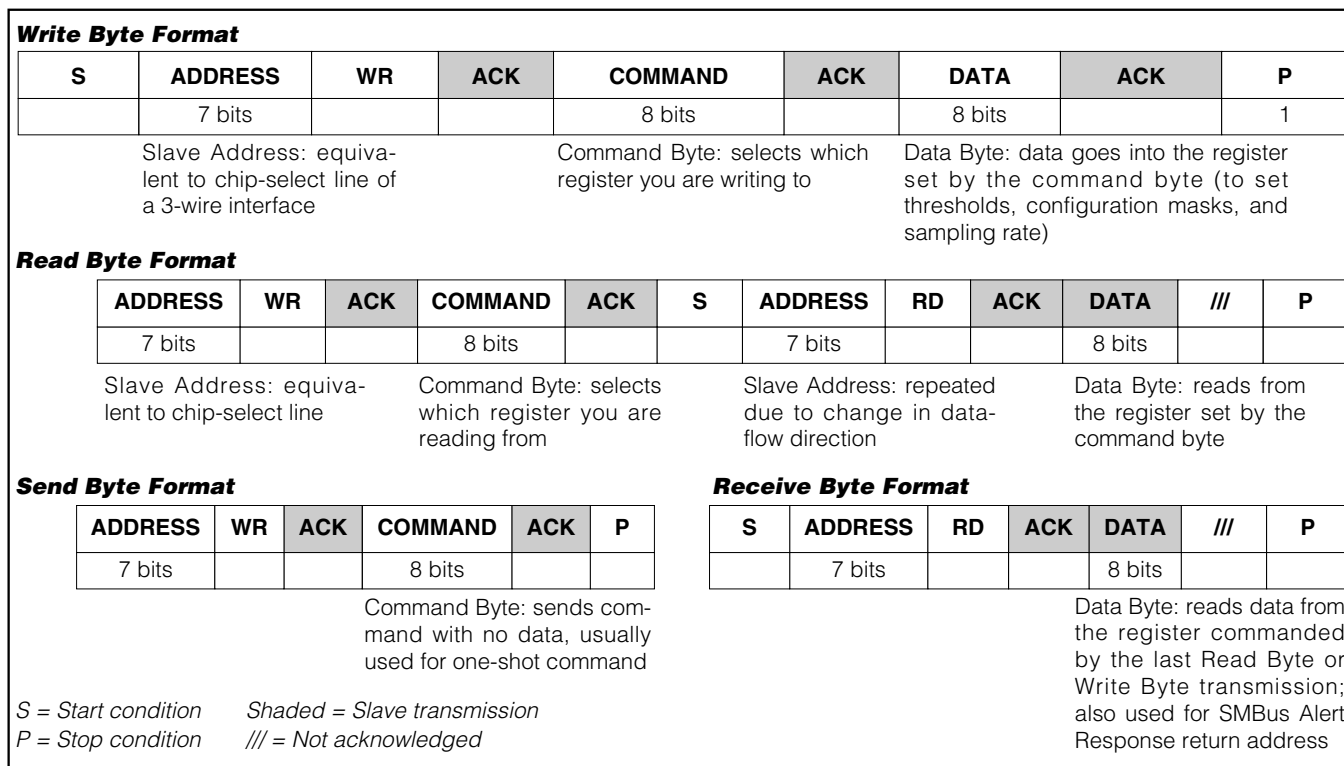

Figure 3. SMBus Protocols

ture registers are not updated. The previous data is not changed and remains available.

SMBus Digital Interface

From a software perspective, the MAX6680/MAX6681 appear as a series of 8-bit registers that contain temperature data, alarm threshold values, and control bits. A standard SMBus-compatible 2-wire serial interface is used to read temperature data and write control bits and alarm threshold data. The device responds to the same SMBus slave address for access to all functions.

The MAX6680/MAX6681 employ four standard SMBus protocols: Write Byte, Read Byte, Send Byte, and Receive Byte (Figure 3). The shorter Receive Byte protocol allows quicker transfers, provided that the correct data register was previously selected by a Read Byte instruction. Use caution with the shorter protocols in multimaster systems, since a second master could overwrite the command byte without informing the first master.

When the conversion rate is 8Hz, temperature data can be read from the Read Internal Temperature (00h) and Read External Temperature (01h) registers. The tem-

perature data format in these registers is 7 bits + sign in two's-complement form for each channel, with the LSB representing 1°C (Table 2). The MSB is transmitted first. Extended range extends the temperature data range of the local and remote sensor to -64°C. Extended range is activated by setting bit 3 of the Configuration register to 1.

When the conversion rate is 4Hz or less, temperature data can be read from the Read Internal Temperature (00h) and Read External Temperature (01h) registers, the same as for faster conversion rates. An additional 3 bits can be read from the Read External Extended Temperature (10h), which extends the remote temperature data to 10 bits + sign and the resolution to 0.125°C per LSB (Table 3).

When a conversion is complete, the Main register and the Extended register are updated almost simultaneously. Ensure that no conversions are completed between reading the Main and Extended registers so that when data that is read by both registers contain the result of the same conversion.

±1°C Fail-Safe Remote/Local Temperature Sensors with SMBus Interface

To ensure valid extended data, read extended resolution temperature data using one of the following approaches:

- 1) Put the MAX6680/MAX6681 into standby mode by setting bit 6 of the Configuration register to 1. Initiate a one-shot conversion using Send Byte command 0Fh. When this conversion is complete, read the contents of the temperature data registers.
- 2) If the MAX6680/MAX6681 are in run mode, read the Status register. If a conversion is in progress, the BUSY bit is set to 1. Wait for the conversion to complete as indicated by the BUSY bit being set to zero, then read the temperature data registers.

Diode Fault Alarm

There is a continuity fault detector at DXP that detects an open circuit between DXP and DXN, or a DXP short to VCC, GND, or DXN. If an open or short circuit exists, the External Temperature register is loaded with 1000 0000. Additionally, if the fault is an open circuit, bit 2 (OPEN) of the Status byte is set to 1 and the ALERT condition is activated at the end of the conversion. Immediately after power-on reset, the Status register indicates that no fault is present until the end of the first conversion.

Alarm Threshold Registers

Four registers store ALERT threshold values—one high-temperature (T_{HIGH}) and one low-temperature (T_{LOW}) register each for the local and remote channels. If either measured temperature equals or exceeds the corresponding ALERT threshold value, the ALERT output is asserted.

The POR state of both ALERT T_{HIGH} registers is 0111 1111 or +127°C and the POR state of T_{LOW} registers is 1100 1001 or -55°C.

Two additional registers, RWOE and RWOI, store remote and local alarm threshold data information corresponding to the OVERT output (see the OVERT *Overtemperature Alarm* section).

ALERT

The ALERT output operates in two modes—the typical interrupt mode and comparator mode. The INT_SEL input determines the mode. When INT_SEL is connected to VCC high, using a weak pullup resistor, or left floating, the ALERT functions in the interrupt mode.

ALERT Interrupt Mode

An ALERT interrupt occurs when the internal or external temperature reading exceeds a high or low temperature limit (user programmed) or when the remote diode is disconnected (for continuity fault detection). The

ALERT interrupt output signal is latched and can be cleared only by either reading the Status register or by successfully responding to an Alert Response address. In both cases, the alert is cleared even if the fault condition still exists, but is reasserted at the end of the next conversion. The interrupt does not halt automatic conversions. The interrupt output pin is open drain so that multiple devices can share a common interrupt line. The interrupt rate never exceeds the conversion rate.

Comparator Mode

Connecting INT_SEL to ground operates the ALERT output in comparator mode. In the comparator mode, whenever the temperature of the remote or local temp sensor goes outside the limits set by T_{HIGH} or T_{LOW}, the ALERT output becomes inactive after the tempera-

Table 2. Data Format (Two's Complement)

TEMP (°C)	LEGACY MODE DIGITAL OUTPUT	EXTENDED RANGE DIGITAL OUTPUT
127.00	0111 1111	0111 1111
25	0001 1001	0001 1001
1	0000 0001	0000 0001
0.00	0000 0000	0000 0000
-1	0000 0000	1111 1111
-25	0000 0000	1110 0111
-64	0000 0000	1000 0000
Diode Fault (Short or Open)	1000 0000	1000 0000

Table 3. Extended Resolution Register

FRACTIONAL TEMPERATURE	CONTENTS OF EXTENDED REGISTER
0.000	000X XXXX
0.125	001X XXXX
0.250	010X XXXX
0.375	011X XXXX
0.500	100X XXXX
0.625	101X XXXX
0.750	110X XXXX
0.875	111X XXXX

Note: Extended mode applies only for conversion rates of 4Hz and slower.

±1°C Fail-Safe Remote/Local Temperature Sensors with SMBus Interface

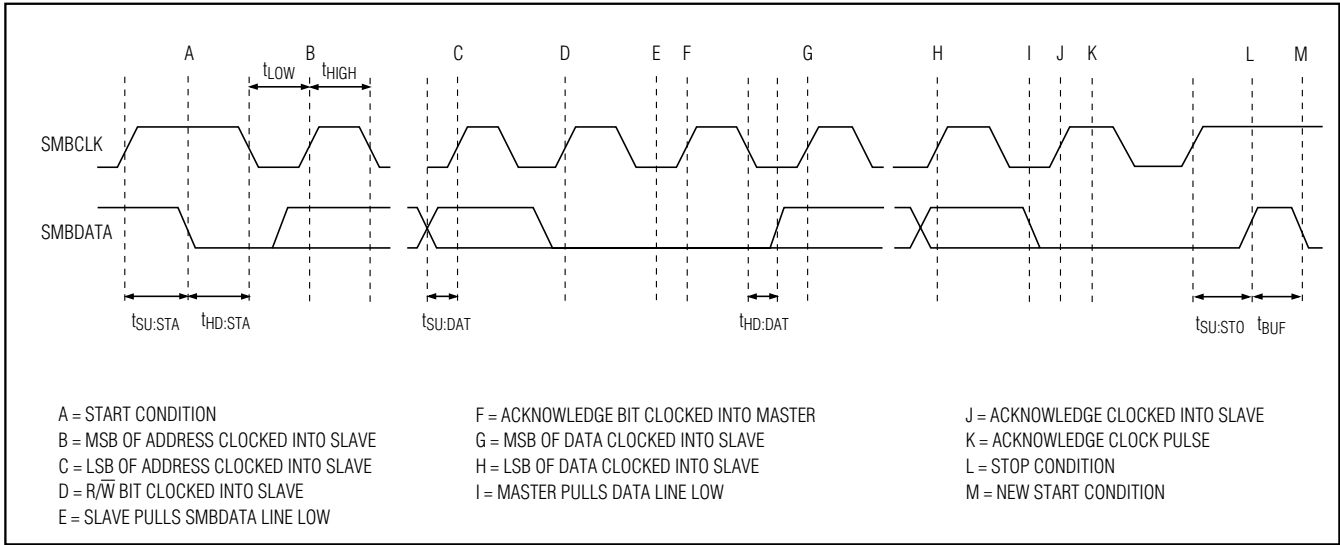

Figure 4. SMBus Write Timing Diagram

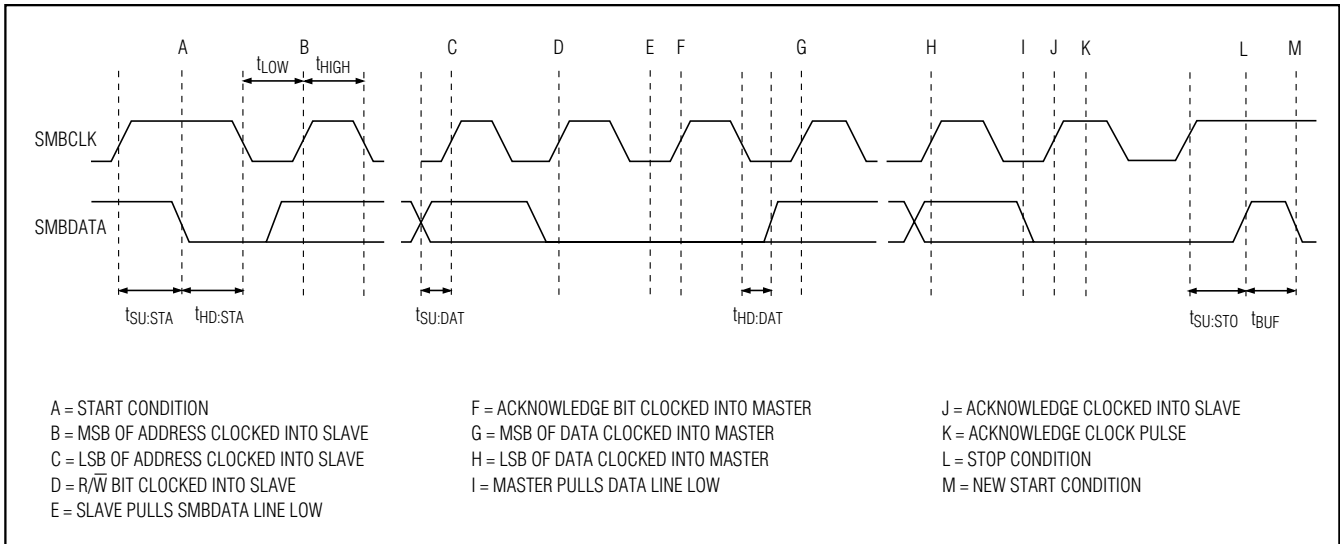

Figure 5. SMBus Read Timing Diagram

ture returns within the limits. An open diode also sets this output.

Alert Response Address

The SMBus Alert Response interrupt pointer provides quick fault identification for simple slave devices that lack the complex, expensive logic needed to be a bus master. Upon receiving an ALERT interrupt signal, the host master can broadcast a Receive Byte transmission to the Alert Response slave address (see the *Slave*

Addresses section). Then, any slave device that generated an interrupt, attempts to identify itself by putting its own address on the bus (Table 4).

The Alert Response can activate several different slave devices simultaneously, similar to the I²C General Call. If more than one slave attempts to respond, bus arbitration rules apply, and the device with the lower address code wins. The losing device does not generate an acknowledge and continues to hold the $\overline{\text{ALERT}}$ line low until cleared. (The conditions for clearing an alert vary

±1°C Fail-Safe Remote/Local Temperature Sensors with SMBus Interface

depending on the type of slave device.) Successful completion of the Alert Response protocol clears the interrupt latch, provided the condition that caused the alert no longer exists. If the condition still exists, the device reasserts the ALERT interrupt at the end of the next conversion.

OVERT Overtemperature Alarm

Two registers, RWOE and RWOI, store remote and local alarm threshold data corresponding to the OVERT output. The values stored in these registers are high-temperature thresholds. If any one of the measured temperatures equals or exceeds the corresponding alarm threshold value, an OVERT output is asserted.

The overtemperature thresholds are both hardware and software programmable. The overtemperature thresholds can be hardware programmed by pin strapping CRIT0 and CRIT1. Use Table 4 to set the desired remote and local threshold temperatures. Upon POR or driving the RESET pin high, the Overtemperature register takes on the hardware-programmed values. Afterward, any write to the Overtemperature registers overwrites the hardware-programmable values.

OVERT always operates in comparator mode and is asserted when the temperature rises to a value programmed in the appropriate threshold register. It is deasserted when the temperature drops below this threshold minus the programmed value in the Hysteresis (HYST) register. An OVERT output can be used to activate a cooling fan, send a warning, initiate clock throttling, or trigger a system shutdown to prevent component damage. The HYST byte sets the amount of hysteresis to deassert the OVERT output. The data format for the HYST byte is 7 bits + sign with 1°C resolution. Bit 7 of the HYST register should always be zero.

Command Byte Functions

The 8-bit Command Byte register (Table 5) is the master index that points to the various other registers within the MAX6680/MAX6681. This register's POR state is 0000 0000, so a Receive Byte transmission (a protocol that lacks the command byte) occurring immediately after POR returns the current local temperature data.

One Shot

The One-Shot command immediately forces a new conversion cycle to begin. If the One-Shot command is received when the MAX6680/MAX6681 is in software standby mode (RUN/STOP bit = 1), a new conversion is begun, after which the device returns to standby mode. If a conversion is in progress when a One-Shot command is received, the command is ignored. If a One-Shot command is received in autoconvert mode (RUN/STOP

Table 4. OVERT Temperature Threshold Programming

CRIT1	CRIT0	OVERT THRESHOLD (°C)	
		REMOTE	LOCAL
GND	GND	+85	+70
GND	Open	+90	+75
GND	V _{CC}	+95	+80
Open	GND	+100	+85
Open	Open	+105	+90
Open	V _{CC}	+110	+95
V _{CC}	GND	+115	+100
V _{CC}	Open	+120	+105
V _{CC}	V _{CC}	+125	+110

bit = 0) between conversions, a new conversion begins, the conversion rate timer is reset, and the next automatic conversion takes place after a full delay elapses.

Configuration Byte Functions

The Configuration Byte register, Table 6, is a read-write register with several functions. Bit 7 is used to mask (disable) ALERT interrupts. Bit 6 puts the device into software standby mode (STOP) or autonomous (RUN) mode. Bit 5 selects the type of external junction (set to 0 for a substrate PNP on an IC or set to 1 for a discrete diode-connected transistor) for optimized measurements. Bit 4 selects the extended temperature measurement for the remote sensor. If high, the temperature data is available as 10 bits + sign with a 0.125°C resolution, otherwise, 7 bits + sign with 1°C resolution. Bit 4 extends the temperature range of the remote and local temperature sensor to -64°C. Bit 2 disables the SMBus timeout, as well as the Alert Response. Bit 1 provides a software reset from the SMBus. Bit 0 is reserved and returns a zero when read.

Status Byte Functions

The status byte (Table 7) indicates which (if any) temperature thresholds have been exceeded. This byte also indicates whether the ADC is converting and if there is an open-circuit fault detected with the external sense junction. After POR, the normal state of the registers' bits is zero, assuming no alert or overtemperature conditions are present. When operating the MAX6680/MAX6681 in ALERT interrupt mode, bits 2 through 6 of the Status register are cleared by any successful read of the Status register, unless the fault persists. The ALERT output follows the status flag bit. Both are cleared when successfully read, but if the condition

$\pm 1^{\circ}\text{C}$ Fail-Safe Remote/Local Temperature Sensors with SMBus Interface

MAX6680/MAX6681

Table 5. Command-Byte Register Bit Assignments

REGISTER	ADDRESS	POR STATE	FUNCTION
RLTS	00h	0000 at 0°C	Read Internal Temperature
RRTE	01h	0000 (0°C)	Read External Temperature
RSL	02h	0000 0000	Read Status Register
RCL/WCL	03h/09h	0010 0000	Read/Write Configuration Byte
RCRA/WCRA	04h/0A	0000 0010	Read/Write Conversion Rate Byte
RIH/WIH	05h/0Bh	0111 1111 (+127°C)	Read/Write Internal $\overline{\text{ALERT}}$ High Limit
RIL/WIL	06h/0Ch	1100 1001 (-55°C)	Read/Write Internal $\overline{\text{ALERT}}$ Low Limit
REH/WEH	07h/0Dh	0100 0110 (+127°C)	Read/Write External $\overline{\text{ALERT}}$ High Limit
REL/WEL	08h/0Eh	1100 1001 (-55°C)	Read/Write External $\overline{\text{ALERT}}$ Low Limit
OSHT	0Fh	0000	One Shot
REET	10h	0000 0000	Read External Extended Temperature
RWOH	11h	0000 0000	Read/Write External Offset High Byte
RWOL	12h	0000 0000	Read/Write External Offset Low Byte
RWOE	19h	See Table 4	Read/Write External $\overline{\text{OVERT}}$ Limit
RWOI	20h	See Table 4	Read/Write Internal $\overline{\text{OVERT}}$ Limit
HYST	21h	0000 0110 (+6°C)	$\overline{\text{OVERT}}$ Hysteresis
RDID	FEh	0100 1101	Read Manufacturer ID
RDRV	Ff	0000 0001	Read Device Revision

still exists, they are reasserted at the end of the next conversion. If the MAX6680/MAX6681 are operating in the comparator mode, bits 2–6 of the Status register are cleared only after the local and/or remote temperatures return within the set limits.

The bits indicating OVTI and OVTE are cleared only when the condition no longer exists. Reading the status byte does not clear the $\overline{\text{OVERT}}$ output or fault bits. One way to eliminate the fault condition is for the measured temperature to drop below the temperature threshold minus the hysteresis value. Another way to eliminate the fault condition is by writing new values for the RWOI, RWOE, or HYST registers so that a fault condition is no longer present.

The MAX6680/MAX6681 incorporate collision avoidance so that completely asynchronous operation is allowed between SMBus operations and temperature conversions.

When autoconverting, if the T_{HIGH} and T_{LOW} limits are close together, it is possible for both high-temp and low-temp status bits to be set, depending on the amount of time between status read operations. In these circumstances, it is best not to rely on the status bits to indicate reversals in long-term temperature changes. Instead use a current temperature reading to establish the trend direction.

Hardware/Software Reset

The MAX6680/MAX6681 reset at power-on if pin 7 is taken high, or by software reset through bit 1 of the Configuration register. When reset occurs, all registers go to default values, and the SMBus address pins are sampled.

Conversion Rate Byte

The Conversion Rate register (Table 8) programs the time interval between conversions in free-running

±1°C Fail-Safe Remote/Local Temperature Sensors with SMBus Interface

Table 6. Configuration-Byte Bit Assignment

BIT	NAME	POR STATE	FUNCTION
7 (MSB)	$\overline{\text{ALERT}}$ MASK	0	Mask $\overline{\text{ALERT}}$ active state when 1. When 1, $\overline{\text{ALERT}}$ does not respond to any fault related to the four limit registers.
6	RUN/STOP	0	Standby mode control bit; if 1, immediately stops converting and enters standby mode. If zero, it converts in either one-shot or timer mode.
5	SPNP	1	When 1, the remote sensor is a common-collector substrate PNP. When zero, the remote sensor is a diode-connected transistor.
4	Extended Resolution	0	When zero, remote- and local-sensors' temperature data are 7 bits + sign with 1°C resolution. When 1, the remote-sensor temperature data is 10 bits + sign with 0.125°C resolution.
3	Extended Range	0	Extended temperature range. 0 = normal, 1 = extended to -64°C.
2	SMBus Timeout	0	When set to 1, it disables the SMBus timeout, as well as the alert response.
1	Software Reset	0	Software reset from SMBus from customer.
0	RFU	0	Reserved

Table 7. Status Register Bit Assignments

BIT	NAME	POR STATE	FUNCTION
7 (MSB)	BUSY	0	When 1, the A/D is busy converting.
6	LHIGH	0	When 1, internal high-temperature alarm has tripped; cleared by POR or readout of the Status register, if the fault condition no longer exists.
5	LLOW	0	When 1, internal low-temperature alarm has tripped; cleared by POR or readout of the Status register, if the fault condition no longer exists.
4	RHIGH	0	When 1, external high-temperature alarm has tripped; cleared by POR or readout of the Status register, if the fault condition no longer exists.
3	RLOW	0	When 1, external low-temperature alarm has tripped; cleared by POR or readout of the Status register if the fault condition no longer exists.
2	OPEN	0	When 1 indicates an external diode open; cleared by POR or readout of the Status register, if the fault condition no longer exists.
1	OVI	0	When 1, internal temperature exceeds the RWOI limit.
0	OVE	0	When 1, external temperature exceeds the RWOE limit.

autonomous mode (RUN/STOP = 0). This variable rate control can be used to reduce the supply current in portable-equipment applications. The conversion rate byte's POR state is 02h (0.25Hz). The MAX6680/MAX6681 use only the 3LSBs of this register. The 5MSBs are "don't care" and should be set to zero when possible. The conversion rate tolerance is ±25% at any rate setting.

Valid A/D conversion results for both channels are available one total conversion time (125ms nominal, 156ms maximum) after initiating a conversion, whether conversion is initiated through the RUN/STOP bit, hardware STBY pin, One-Shot command, or initial power-up.

Slave Addresses

The MAX6680/MAX6681 device address can be initially set to nine different values by pin strapping ADD0 and ADD1 so that more than one MAX6680/MAX6681 can

±1°C Fail-Safe Remote/Local Temperature Sensors with SMBus Interface

reside on the same bus without address conflicts (Table 9).

The address pin states are checked at POR and RESET only, and the address data stays latched to reduce quiescent supply current due to the bias current needed for high-Z state detection. The MAX6680/MAX6681 also respond to the SMBus Alert Response slave address (see the *Alert Response Address* section).

POR and UVLO

The MAX6680/MAX6681 have a volatile memory. To prevent unreliable power-supply conditions from corrupting the data in memory and causing erratic behavior, a POR voltage detector monitors V_{CC} and clears the memory if V_{CC} falls below 1.91V (typ, see *Electrical Characteristics*). When power is first applied and V_{CC} rises above 2.0V (typ), the logic blocks begin operating, although reads and writes at V_{CC} levels below 3.0V are not recommended. A second V_{CC} comparator, the ADC UVLO comparator, prevents the ADC from converting until there is sufficient headroom (V_{CC} = 2.8V typ).

Power-Up Defaults

- Interrupt latch is cleared.
- Address select pin is sampled.
- ADC begins autoconverting at a 1Hz rate (legacy resolution).
- Command register is set to 00h to facilitate quick internal Receive Byte queries.
- T_{HIGH} and T_{LOW} registers are set to max and min limits, respectively.
- Hysteresis is set to 6°C.
- Transistor type is set to a substrate or common-collector PNP.

Temperature Offset

The MAX6680/MAX6681 are designed to provide ±1°C accuracy for common microprocessors and discrete transistors. To accommodate processes that differ significantly in their ideality factor, the user can increase/decrease the Remote Temperature Sensor Data register with an offset by writing to the External Offset High and Low Byte registers (11h and 12h, respectively). The offset temperature data is represented as a 10 bits + sign with a 0.125LSB resolution.

Table 8. Conversion-Rate Control Byte

DATA	CONVERSION RATE (Hz)
00h	0.0625
01h	0.125
02h	0.25
03h	0.5
04h	1
05h	2
06h	4
07h	8

Note: If extended resolution is selected using bit 4 of the Configuration register, the extended conversion is limited to a maximum of 4Hz.

Table 9. POR Slave Address Decoding (ADD0 and ADD1)

ADD0	ADD1	ADDRESS
GND	GND	0011 000
GND	HIGH-Z	0011 001
GND	V _{CC}	0011 010
HIGH-Z	GND	0101 001
HIGH-Z	HIGH-Z	0101 010
HIGH-Z	V _{CC}	0101 011
V _{CC}	GND	1001 100
V _{CC}	HIGH-Z	1001 101
V _{CC}	V _{CC}	1001 110

Chip Information

TRANSISTOR COUNT: 17,150

PROCESS: BiCMOS

±1°C Fail-Safe Remote/Local Temperature Sensors with SMBus Interface

Pin Configurations

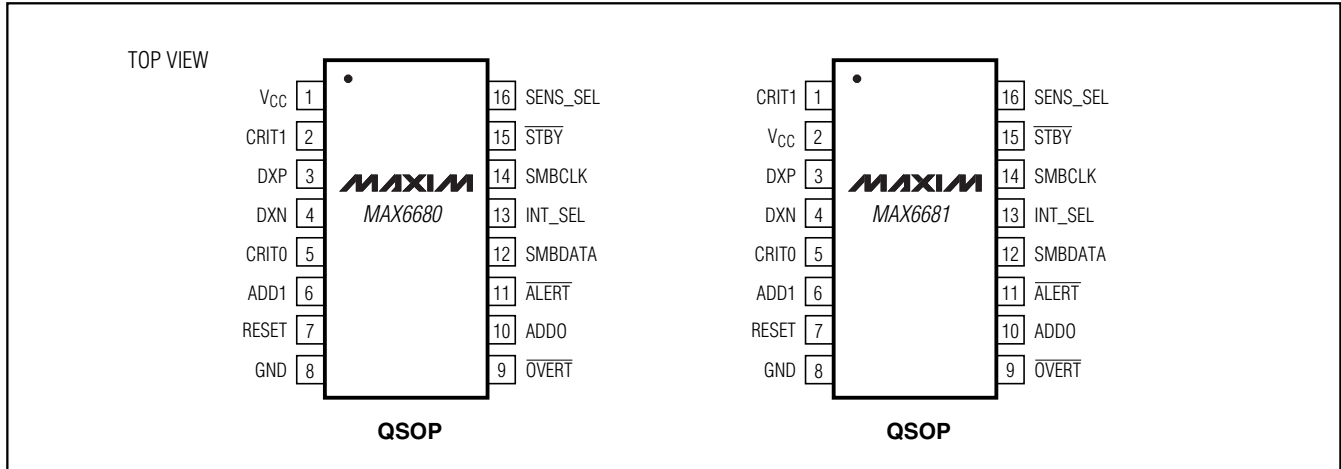

±1°C Fail-Safe Remote/Local Temperature Sensors with SMBus Interface

Package Information

(The package drawing(s) in this data sheet may not reflect the most current specifications. For the latest package outline information, go to www.maxim-ic.com/packages.)

MAX6680/MAX6681

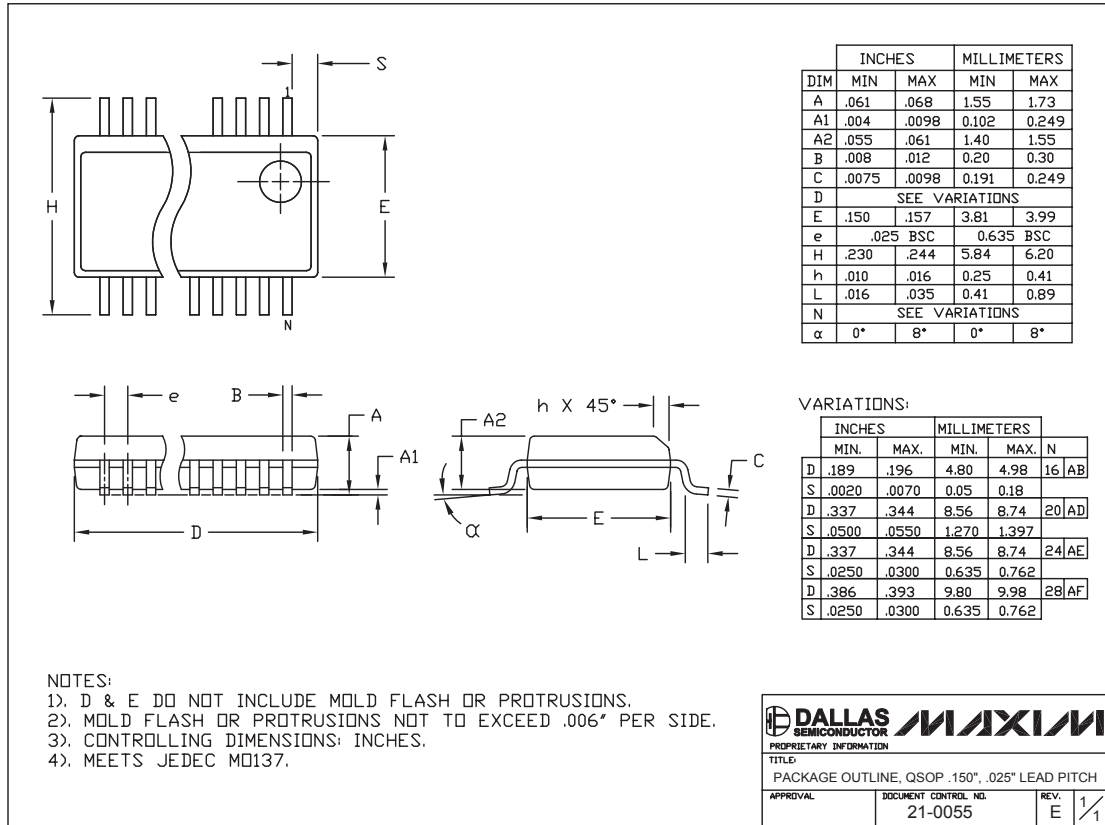

Maxim cannot assume responsibility for use of any circuitry other than circuitry entirely embodied in a Maxim product. No circuit patent licenses are implied. Maxim reserves the right to change the circuitry and specifications without notice at any time.

Maxim Integrated Products, 120 San Gabriel Drive, Sunnyvale, CA 94086 408-737-7600 _____ 17

X-ON Electronics

Largest Supplier of Electrical and Electronic Components

Click to view similar products for [Board Mount Temperature Sensors](#) category:

Click to view products by [Maxim](#) manufacturer:

Other Similar products are found below :

[5962-8757102XA](#) [66F115](#) [EMC1063-1-ACZL-TR](#) [NCT218FCT2G](#) [O53GAB175A-160Y](#) [3610085020002](#) [389049M9527](#) [MIKROE-912](#)
[ADM1023ARQZ-REEL](#) [ADM1032ARMZ-1RL](#) [AT30TS74-U1FMBB-T](#) [AT30TS74-U1FMAB-T](#) [AT30TS74-U1FMCB-T](#) [AT30TS74-](#)
[U1FMDB-T](#) [ADT7483AARQZ-RL](#) [ADT7481ARMZ-REEL](#) [ADT7463ARQZ-REEL](#) [MCP98243T-BE/MC](#) [66L080-0226](#) [5962-8757103XA](#)
[S-58LM20A-I4T1U](#) [NCT375MNR2G](#) [LM84CIMQA](#) [CAT34TS00VP2GT4A](#) [NCT80DBR2G](#) [SEN-16304](#) [GX21M15](#) [GX122](#) [NST175H-](#)
[QSPR](#) [TC6501P065VCTTR](#) [AT-1U](#) [MCP9700AT-E/LT](#) [MCP9701-E/TO](#) [MCP9803-M/MS](#) [MCP9701A-E/TO](#) [LM57FEPWQ1](#) [LM57FPW](#)
[LM57FSPWQ1](#) [60-41123102-0150.0010](#) [60-43123102-0150.0010](#) [60-53123102-0150.0010](#) [MLX90615SSG-DAA-000-TU](#) [TMP303CDRLR](#)
[TC6501P055VCTTR](#) [TC6503P005VCTTR](#) [ADT7311WTRZ-RL](#) [ADT7311WTRZ-RL7](#) [ADT7473ARQZ-REEL](#) [LM335AM](#)
[LM335AM/NOPB](#)