



# 7-Channel Precision Temperature Monitor with Beta Compensation

## ABSOLUTE MAXIMUM RATINGS

$V_{CC}$ , SMBCLK, SMBDATA, $\overline{ALERT}$ , $\overline{OVERT}$ , STBY to GND .....	-0.3V to +6.0V
DXP_ to GND .....	-0.3V to ( $V_{CC}$ + 0.3V)
DXN_ to GND .....	-0.3V to +0.8V
SMBDATA, $\overline{ALERT}$ , $\overline{OVERT}$ Current .....	-1mA to +50mA
DXN_ Current .....	$\pm 1$ mA
Continuous Power Dissipation ( $T_A = +70^\circ\text{C}$ ) 20-Pin TSSOP (derate 13.6mW/ $^\circ\text{C}$ above $+70^\circ\text{C}$ ) .....	1084mW

Junction-to-Case Thermal Resistance ( $\theta_{JC}$ ) (Note 1) 20-Pin TSSOP .....	$20^\circ\text{C}/\text{W}$
Junction-to-Ambient Thermal Resistance ( $\theta_{JA}$ ) (Note 1) 20-Pin TSSOP .....	$73.8^\circ\text{C}/\text{W}$
ESD Protection (all pins, Human Body Model) .....	$\pm 2$ kV
Operating Temperature Range .....	$-40^\circ\text{C}$ to $+125^\circ\text{C}$
Junction Temperature .....	$+150^\circ\text{C}$
Storage Temperature Range .....	$-65^\circ\text{C}$ to $+150^\circ\text{C}$
Lead Temperature (soldering, 10s) .....	$+300^\circ\text{C}$

**Note 1:** Package thermal resistances were obtained using the method described in JEDEC specification JESD51-7, using a four-layer board. For detailed information on package thermal considerations, refer to [www.maxim-ic.com/thermal-tutorial](http://www.maxim-ic.com/thermal-tutorial).

Stresses beyond those listed under "Absolute Maximum Ratings" may cause permanent damage to the device. These are stress ratings only, and functional operation of the device at these or any other conditions beyond those indicated in the operational sections of the specifications is not implied. Exposure to absolute maximum rating conditions for extended periods may affect device reliability.

## ELECTRICAL CHARACTERISTICS

( $V_{CC} = +3.0\text{V}$  to  $+3.6\text{V}$ ,  $V_{\overline{STBY}} = V_{CC}$ ,  $T_A = -40^\circ\text{C}$  to  $+125^\circ\text{C}$ , unless otherwise noted. Typical values are at  $V_{CC} = +3.3\text{V}$  and  $T_A = +25^\circ\text{C}$ .) (Note 2)

PARAMETER	SYMBOL	CONDITIONS	MIN	TYP	MAX	UNITS
Supply Voltage	$V_{CC}$		3.0		3.6	V
Software Standby Supply Current	$I_{SS}$	SMBus static		3	10	$\mu\text{A}$
Operating Current	$I_{CC}$	During conversion (Note 3)		500	2000	$\mu\text{A}$
Temperature Resolution		Channel 1 only		11		Bits
		Other diode channels		8		
3 $\sigma$ Temperature Accuracy (Remote Channel 1)		$V_{CC} = 3.3\text{V}$ , $\beta = 0.5$	$T_A = T_{RJ} = +60^\circ\text{C}$ to $+100^\circ\text{C}$	-1.5	+1.5	$^\circ\text{C}$
			$T_A = T_{RJ} = 0^\circ\text{C}$ to $+125^\circ\text{C}$	-2.375	+2.375	
3 $\sigma$ Temperature Accuracy (Remote Channels 2–6)		$V_{CC} = 3.3\text{V}$	$T_A = T_{RJ} = +60^\circ\text{C}$ to $+100^\circ\text{C}$	-2	+2	$^\circ\text{C}$
			$T_A = T_{RJ} = 0^\circ\text{C}$ to $+125^\circ\text{C}$	-2.5	+2.5	
3 $\sigma$ Temperature Accuracy (Local)		$V_{CC} = 3.3\text{V}$	$T_A = +60^\circ\text{C}$ to $+100^\circ\text{C}$	-2	+2	$^\circ\text{C}$
			$T_A = 0^\circ\text{C}$ to $+125^\circ\text{C}$	-2.5	+2.5	
6 $\sigma$ Temperature Accuracy (Remote Channel 1)		$V_{CC} = 3.3\text{V}$ , $\beta = 0.5$	$T_A = T_{RJ} = +60^\circ\text{C}$ to $+100^\circ\text{C}$	-3	+3	$^\circ\text{C}$
			$T_A = T_{RJ} = 0^\circ\text{C}$ to $+125^\circ\text{C}$	-4	+4	
6 $\sigma$ Temperature Accuracy (Remote Channels 2–6)		$V_{CC} = 3.3\text{V}$	$T_A = T_{RJ} = +60^\circ\text{C}$ to $+100^\circ\text{C}$	-3	+3	$^\circ\text{C}$
			$T_A = T_{RJ} = 0^\circ\text{C}$ to $+125^\circ\text{C}$	-3.5	+3.5	
6 $\sigma$ Temperature Accuracy (Local)		$V_{CC} = 3.3\text{V}$	$T_A = +60^\circ\text{C}$ to $+100^\circ\text{C}$	-2.5	+2.5	$^\circ\text{C}$
			$T_A = 0^\circ\text{C}$ to $+125^\circ\text{C}$	-3	+3	
Supply Sensitivity of Temperature Accuracy				$\pm 0.2$		$^\circ\text{C}/\text{V}$
Remote Channel 1 Conversion Time	$t_{CONV1}$		190	250	312	ms
Remote Channels 2–6 Conversion Time	$t_{CONV\_}$		95	125	156	ms

# 7-Channel Precision Temperature Monitor with Beta Compensation

MAX6693

## ELECTRICAL CHARACTERISTICS (continued)

( $V_{CC} = +3.0V$  to  $+3.6V$ ,  $V_{STBY} = V_{CC}$ ,  $T_A = -40^{\circ}C$  to  $+125^{\circ}C$ , unless otherwise noted. Typical values are at  $V_{CC} = +3.3V$  and  $T_A = +25^{\circ}C$ .) (Note 2)

PARAMETER	SYMBOL	CONDITIONS	MIN	TYP	MAX	UNITS
Remote-Diode Source Current	$I_{RJ}$	High level, channel 1		500		$\mu A$
		Low level, channel 1		20		
		High level, channels 2–6	80	100	120	
		Low level, channels 2–6	8	10	12	
Undervoltage-Lockout Threshold	UVLO	Falling edge of $V_{CC}$ disables ADC	2.30	2.80	2.95	V
Undervoltage-Lockout Hysteresis				90		mV
Power-On Reset (POR) Threshold		$V_{CC}$ falling edge	1.20	2	2.25	V
POR Threshold Hysteresis				90		mV
<b>ALERT, OVERT</b>						
Output Low Voltage	$V_{OL}$	$I_{SINK} = 1mA$			0.3	V
		$I_{SINK} = 6mA$			0.5	
Output Leakage Current					1	$\mu A$
<b>SMBus INTERFACE (SMBCLK, SMBDATA), STBY</b>						
Logic-Input Low Voltage	$V_{IL}$				0.8	V
Logic-Input High Voltage	$V_{IH}$	$V_{CC} = 3.0V$	2.2			V
Input Leakage Current			-1		+1	$\mu A$
Output Low Voltage	$V_{OL}$	$I_{SINK} = 6mA$			0.3	V
Input Capacitance	$C_{IN}$			5		pF
<b>SMBus-COMPATIBLE TIMING (Figures 3 and 4) (Note 4)</b>						
Serial-Clock Frequency	$f_{SMBCLK}$	(Note 5)			400	kHz
Bus Free Time Between STOP and START Condition	$t_{BUF}$	$f_{SMBCLK} = 100kHz$	4.7			$\mu s$
		$f_{SMBCLK} = 400kHz$	1.6			
START Condition Setup Time		$f_{SMBCLK} = 100kHz$	4.7			$\mu s$
		$f_{SMBCLK} = 400kHz$	0.6			
Repeat START Condition Setup Time	$t_{SU:STA}$	90% of SMBCLK to 90% of SMBDATA, $f_{SMBCLK} = 100kHz$	0.6			$\mu s$
		90% of SMBCLK to 90% of SMBDATA, $f_{SMBCLK} = 400kHz$	0.6			
START Condition Hold Time	$t_{HD:STA}$	10% of SMBDATA to 90% of SMBCLK	0.6			$\mu s$
STOP Condition Setup Time	$t_{SU:STO}$	90% of SMBCLK to 90% of SMBDATA, $f_{SMBCLK} = 100kHz$	4			$\mu s$
		90% of SMBCLK to 90% of SMBDATA, $f_{SMBCLK} = 400kHz$	0.6			

# 7-Channel Precision Temperature Monitor with Beta Compensation

## ELECTRICAL CHARACTERISTICS (continued)

( $V_{CC} = +3.0V$  to  $+3.6V$ ,  $V_{STBY} = V_{CC}$ ,  $T_A = -40^{\circ}C$  to  $+125^{\circ}C$ , unless otherwise noted. Typical values are at  $V_{CC} = +3.3V$  and  $T_A = +25^{\circ}C$ .) (Note 2)

PARAMETER	SYMBOL	CONDITIONS	MIN	TYP	MAX	UNITS
Clock-Low Period	$t_{LOW}$	10% to 10%, $f_{SMBCLK} = 100kHz$	1.3			$\mu s$
		10% to 10%, $f_{SMBCLK} = 400kHz$	1.3			
Clock-High Period	$t_{HIGH}$	90% to 90%	0.6			$\mu s$
Data Hold Time	$t_{HD:DAT}$	$f_{SMBCLK} = 100kHz$	300			ns
		$f_{SMBCLK} = 400kHz$ (Note 6)			900	
Data Setup Time	$t_{SU:DAT}$	$f_{SMBCLK} = 100kHz$	250			ns
		$f_{SMBCLK} = 400kHz$	100			
Receive SMBCLK/SMBDATA Rise Time	$t_R$	$f_{SMBCLK} = 100kHz$			1	$\mu s$
		$f_{SMBCLK} = 400kHz$			0.3	
Receive SMBCLK/SMBDATA Fall Time	$t_F$				300	ns
Pulse Width of Spike Suppressed	$t_{SP}$		0		50	ns
SMBus Timeout	$t_{TIMEOUT}$	SMBDATA low period for interface reset	25	37	45	ms

**Note 2:** All parameters are tested at  $T_A = +85^{\circ}C$ . Specifications over temperature are guaranteed by design.

**Note 3:** Beta = 0.5 for channel 1 remote transistor.

**Note 4:** Timing specifications are guaranteed by design.

**Note 5:** The serial interface resets when SMBCLK is low for more than  $t_{TIMEOUT}$ .

**Note 6:** A transition must internally provide at least a hold time to bridge the undefined region (300ns max) of SMBCLK's falling edge.

# 7-Channel Precision Temperature Monitor with Beta Compensation

## Typical Operating Characteristics

( $V_{CC} = 3.3V$ ,  $V_{STBY} = V_{CC}$ ,  $T_A = +25^\circ C$ , unless otherwise noted.)

MAX6693

**SOFTWARE STANDBY SUPPLY CURRENT vs. SUPPLY VOLTAGE**

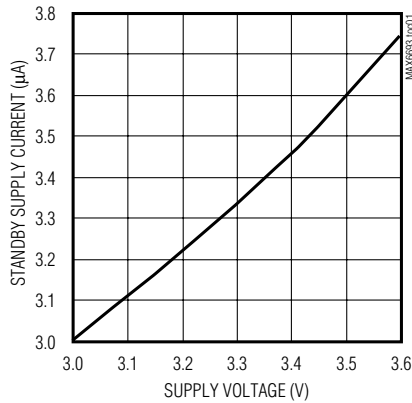

**SUPPLY CURRENT vs. SUPPLY VOLTAGE**

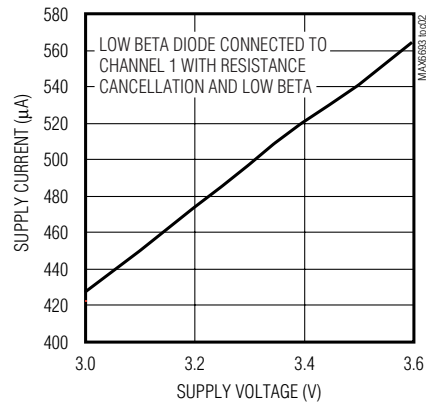

**REMOTE-DIODE TEMPERATURE ERROR vs. REMOTE-DIODE TEMPERATURE**

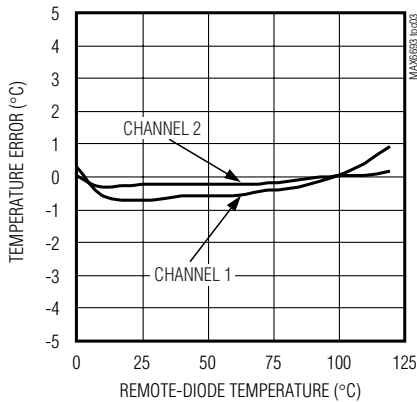

**LOCAL TEMPERATURE ERROR vs. DIE TEMPERATURE**

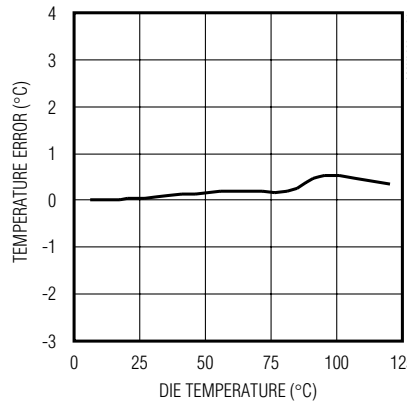

**REMOTE-DIODE TEMPERATURE ERROR vs. POWER-SUPPLY NOISE FREQUENCY**

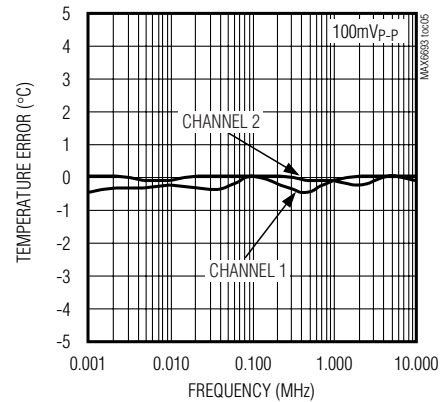

**LOCAL TEMPERATURE ERROR vs. POWER-SUPPLY NOISE FREQUENCY**

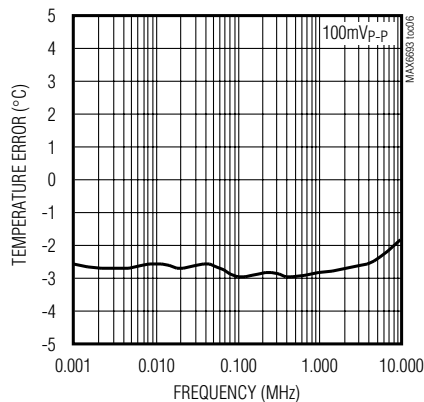

**CH 2 REMOTE-DIODE TEMPERATURE ERROR vs. COMMON-MODE NOISE FREQUENCY**

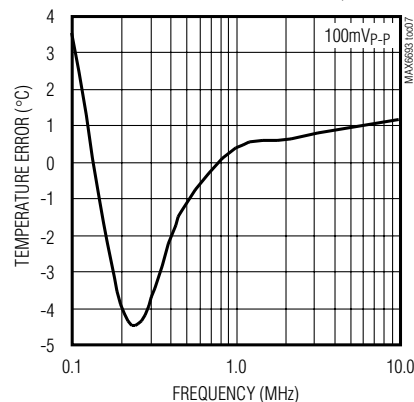

# 7-Channel Precision Temperature Monitor with Beta Compensation

## Typical Operating Characteristics (continued)

( $V_{CC} = 3.3V$ ,  $V_{STBY} = V_{CC}$ ,  $T_A = +25^\circ C$ , unless otherwise noted.)

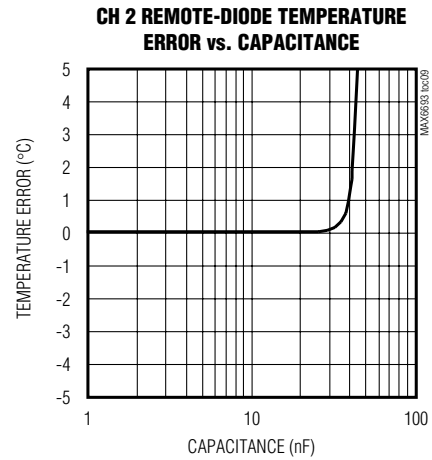
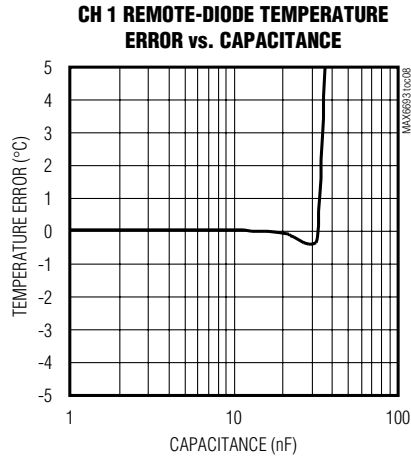

## Pin Description

PIN	NAME	FUNCTION
1	DXP1	Combined Current Source and A/D Positive Input for Channel 1 Remote Transistor. Connect to the emitter of a low-beta transistor. Leave unconnected or connect to $V_{CC}$ if no remote transistor is used. Place a 100pF capacitor between DXP1 and DXN1 for noise filtering.
2	DXN1	Base Input for Channel 1 Remote Diode. Connect to the base of a PNP temperature-sensing transistor.
3	DXP2	Combined Current Source and A/D Positive Input for Channel 2 Remote Diode. Connect to the anode of a remote-diode-connected temperature-sensing transistor. Leave unconnected or connect to $V_{CC}$ if no remote diode is used. Place a 100pF capacitor between DXP2 and DXN2 for noise filtering.
4	DXN2	Cathode Input for Channel 2 Remote Diode. Connect the cathode of the channel 2 remote-diode-connected transistor to DXN2.
5	DXP3	Combined Current Source and A/D Positive Input for Channel 3 Remote Diode. Connect to the anode of a remote-diode-connected temperature-sensing transistor. Leave unconnected or connect to $V_{CC}$ if no remote diode is used. Place a 100pF capacitor between DXP3 and DXN3 for noise filtering.
6	DXN3	Cathode Input for Channel 3 Remote Diode. Connect the cathode of the channel 3 remote-diode-connected transistor to DXN3.
7	DXP4	Combined Current Source and A/D Positive Input for Channel 4 Remote Diode. Connect to the anode of a remote-diode-connected temperature-sensing transistor. Leave unconnected or connect to $V_{CC}$ if no remote diode is used. Place a 100pF capacitor between DXP4 and DXN4 for noise filtering.
8	DXN4	Cathode Input for Channel 4 Remote Diode. Connect the cathode of the channel 4 remote-diode-connected transistor to DXN4.

# 7-Channel Precision Temperature Monitor with Beta Compensation

MAX6693

## Pin Description (continued)

PIN	NAME	FUNCTION
9	DXP5	Combined Current Source and A/D Positive Input for Channel 5 Remote Diode. Connect to the anode of a remote-diode-connected temperature-sensing transistor. Leave unconnected or connect to V <sub>CC</sub> if no remote diode is used. Place a 100pF capacitor between DXP5 and DXN5 for noise filtering.
10	DXN5	Cathode Input for Channel 5 Remote Diode. Connect the cathode of the channel 5 remote-diode-connected transistor to DXN5.
11	DXN6	Cathode Input for Channel 6 Remote Diode. Connect the cathode of the channel 6 remote-diode-connected transistor to DXN6.
12	DXP6	Combined Current Source and A/D Positive Input for Channel 6 Remote Diode. Connect to the anode of a remote-diode-connected temperature-sensing transistor. Leave unconnected or connect to V <sub>CC</sub> if no remote diode is used. Place a 100pF capacitor between DXP6 and DXN6 for noise filtering.
13	$\overline{\text{STBY}}$	Active-Low Standby Input. Drive $\overline{\text{STBY}}$ logic-low to place the MAX6693 in standby mode, or logic-high for operate mode. Temperature and threshold data are retained in standby mode.
14	N.C.	No Connection. Must be connected to ground.
15	$\overline{\text{OVERT}}$	Overtemperature Active-Low, Open-Drain Output. $\overline{\text{OVERT}}$ asserts low when the temperature of channels 1, 4, 5, and 6 exceeds the programmed threshold limit.
16	V <sub>CC</sub>	Supply Voltage Input. Bypass to GND with a 0.1μF capacitor.
17	$\overline{\text{ALERT}}$	SMBus Alert (Interrupt), Active-Low, Open-Drain Output. $\overline{\text{ALERT}}$ asserts low when the temperature of any channel exceeds the programmed $\overline{\text{ALERT}}$ threshold.
18	SMBDATA	SMBus Serial Data Input/Output. Connect to a pullup resistor.
19	SMBCLK	SMBus Serial Clock Input. Connect to a pullup resistor.
20	GND	Ground

## Detailed Description

The MAX6693 is a precision multichannel temperature monitor that features one local and six remote temperature-sensing channels with a programmable alert threshold for each temperature channel and a programmable overtemperature threshold for channels 1, 4, 5, and 6 (see Figure 1). Communication with the MAX6693 is achieved through the SMBus serial interface and a dedicated alert pin. The alarm outputs,  $\overline{\text{OVERT}}$  and  $\overline{\text{ALERT}}$ , assert if the software-programmed temperature thresholds are exceeded.  $\overline{\text{ALERT}}$  typically serves as an interrupt, while  $\overline{\text{OVERT}}$  can be connected to a fan, system shutdown, or other thermal-management circuitry.

### ADC Conversion Sequence

In the default conversion mode, the MAX6693 starts the conversion sequence by measuring the temperature on channel 1, followed by 2, 3, local channel, 4, 5, and 6. The conversion result for each active channel is stored in the corresponding temperature data register.

### Low-Power Standby Mode

Enter software standby mode by setting the STOP bit to 1 in the configuration 1 register. Enter hardware standby by pulling  $\overline{\text{STBY}}$  low. Software standby mode disables the ADC and reduces the supply current to approximately 3μA. Hardware standby mode halts the ADC clock, but the supply current is approximately 350μA. During either software or hardware standby, data is retained in memory. During hardware standby, the SMBus interface is inactive. During software standby, the SMBus interface is active and listening for commands. The timeout is enabled if a start condition is recognized on SMBus. Activity on the SMBus causes the supply current to increase. If a standby command is received while a conversion is in progress, the conversion cycle is interrupted, and the temperature registers are not updated. The previous data is not changed and remains available.

# 7-Channel Precision Temperature Monitor with Beta Compensation

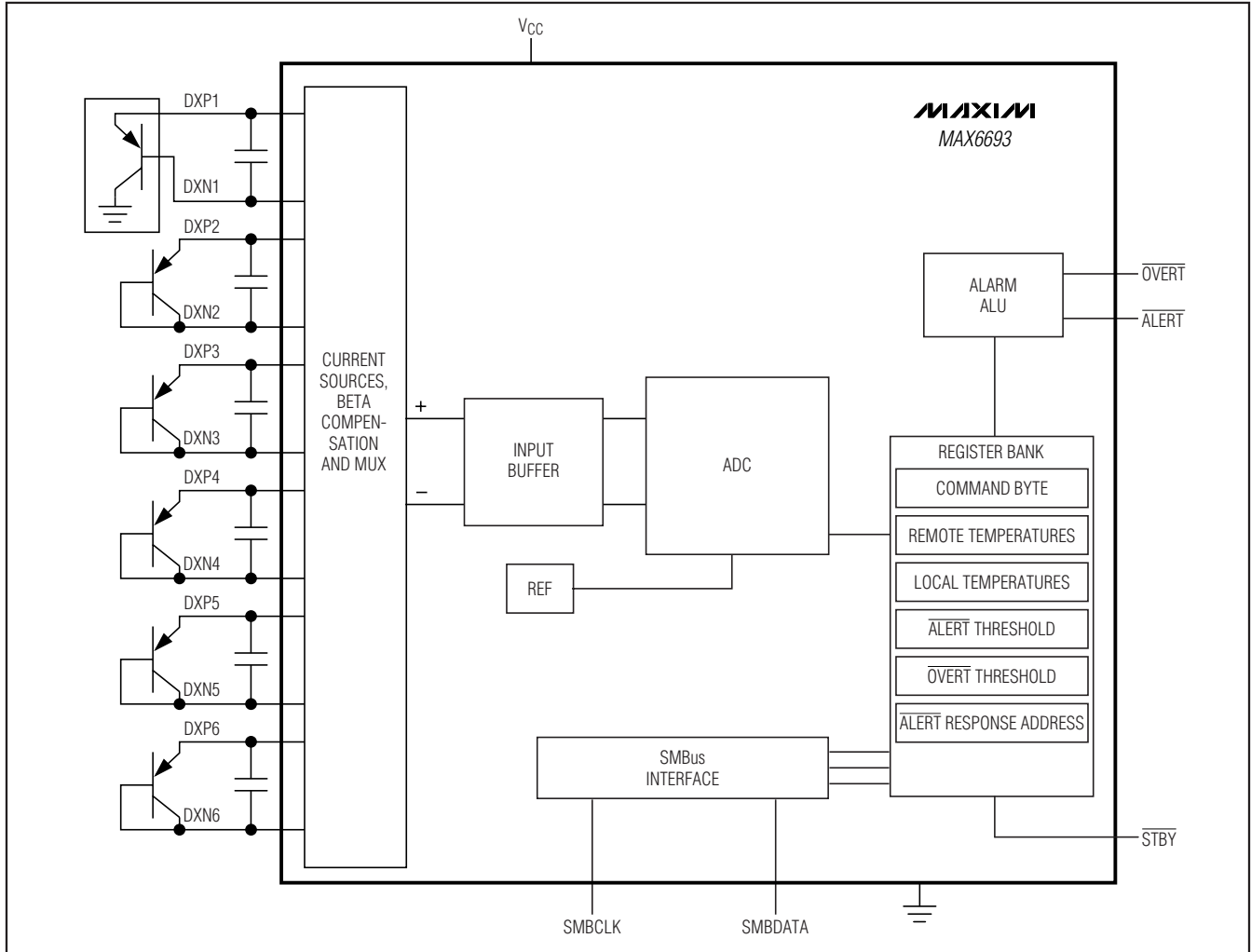

Figure 1. Internal Block Diagram

### Operating-Current Calculation

The MAX6693 operates at different operating-current levels depending on how many external channels are in use. Assume that  $I_{CC1}$  is the operating current when the MAX6693 is converting the remote channel 1 and  $I_{CC2}$  is the operating current when the MAX6693 is converting the other channels. For the MAX6693 with remote channel 1 and  $n$  other remote channels connected, the operating current is:

$$I_{CC} = (2 \times I_{CC1} + I_{CC2} + n \times I_{CC2}) / (n + 3)$$

### SMBus Digital Interface

From a software perspective, the MAX6693 appears as a series of 8-bit registers that contain temperature measurement data, alarm threshold values, and control bits. A standard SMBus-compatible, 2-wire serial interface is used to read temperature data and write control bits and alarm threshold data. The same SMBus slave address also provides access to all functions.



# 7-Channel Precision Temperature Monitor with Beta Compensation

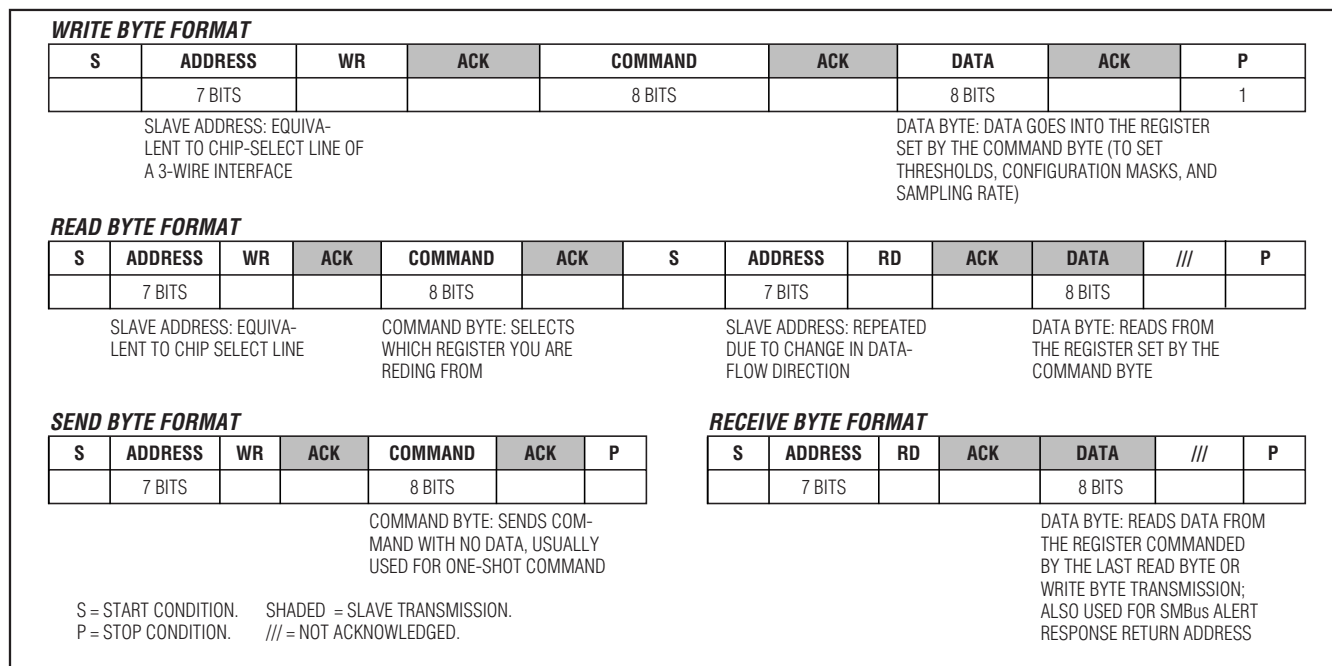

Figure 2. SMBus Protocols

**Table 1. Main Temperature Register (High-Byte) Data Format**

TEMP (°C)	DIGITAL OUTPUT
> +127	0111 1111
+127	0111 1111
+126	0111 1110
+25	0001 1001
0	0000 0000
< 0	0000 0000
Diode fault (open or short)	1111 1111

The MAX6693 employs four standard SMBus protocols: write byte, read byte, send byte, and receive byte (Figure 2). The shorter receive byte protocol allows quicker transfers, provided that the correct data register was previously selected by a read byte instruction. Use caution with the shorter protocols in multimaster systems, since a second master could overwrite the command byte without informing the first master. Figure 3 is the SMBus write-timing diagram and Figure 4 is the SMBus read-timing diagram.

The remote diode 1 measurement channel provides 11 bits of data (1 LSB = 0.125°C). All other temperature-measurement channels provide 8 bits of temperature

**Table 2. Extended Resolution Temperature Register (Low-Byte) Data Format**

TEMP (°C)	DIGITAL OUTPUT
0	000X XXXX
+0.125	001X XXXX
+0.250	010X XXXX
+0.375	011X XXXX
+0.500	100X XXXX
+0.625	101X XXXX
+0.750	110X XXXX
+0.875	111X XXXX

data (1 LSB = 1°C). The 8 most significant bits (MSBs) can be read from the local temperature and remote temperature registers. The remaining 3 bits for remote diode 1 can be read from the extended temperature register. If extended resolution is desired, the extended resolution register should be read first. This prevents the most significant bits from being overwritten by new conversion results until they have been read. If the most significant bits have not been read within an SMBus timeout period (nominally 37ms), normal updating continues. Table 1 shows the main temperature register (high-byte) data format, and Table 2 shows the extended resolution register (low-byte) data format.

# 7-Channel Precision Temperature Monitor with Beta Compensation

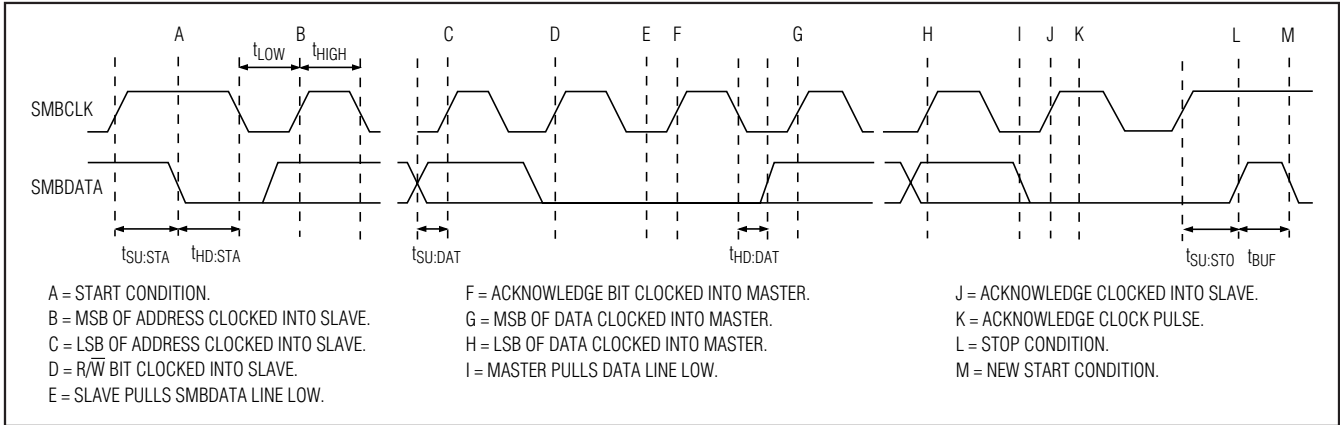

Figure 3. SMBus Write-Timing Diagram

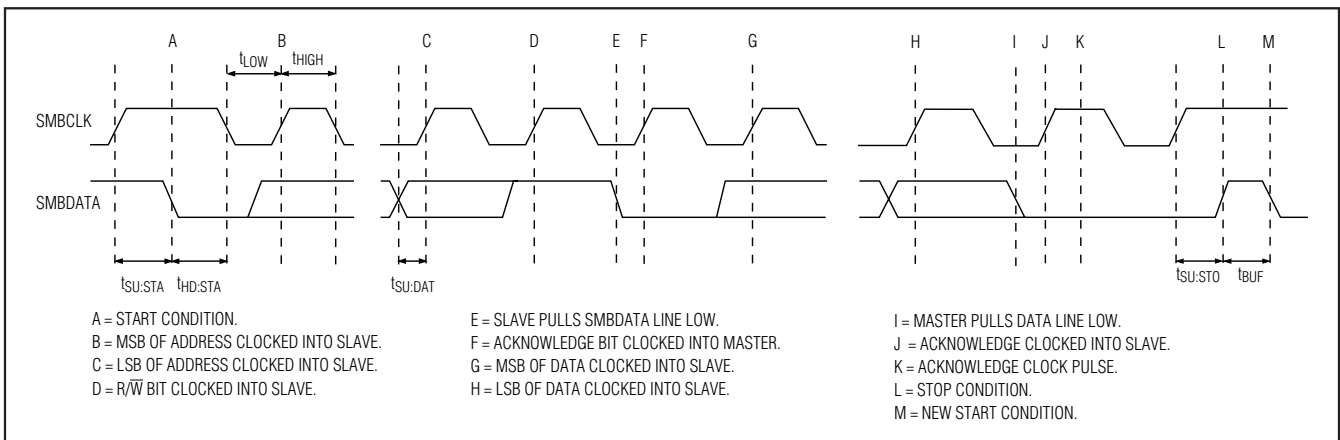

Figure 4. SMBus Read-Timing Diagram

## Diode Fault Detection

If a channel's input  $DXP_{-}$  and  $DXN_{-}$  are left open, the MAX6693 detects a diode fault. An open diode fault does not cause either  $\overline{ALERT}$  or  $\overline{OVERT}$  to assert. A bit in the status register for the corresponding channel is set to 1 and the temperature data for the channel is stored as all 1s (FFh). It takes approximately 4ms for the MAX6693 to detect a diode fault. Once a diode fault is detected, the MAX6693 goes to the next channel in the conversion sequence.

## Alarm Threshold Registers

There are 11 alarm threshold registers that store over-temperature  $\overline{ALERT}$  and  $\overline{OVERT}$  threshold values. Seven of these registers are dedicated to storing one local alert temperature threshold limit and six remote alert temperature threshold limits (see the  $\overline{ALERT}$  Interrupt Mode section). The remaining four registers are dedicated to remote channels 1, 4, 5, and 6 to store overtemperature threshold limits

(see the  $\overline{OVERT}$  Overtemperature Alarms section). Access to these registers is provided through the SMBus interface.

## $\overline{ALERT}$ Interrupt Mode

An  $\overline{ALERT}$  interrupt occurs when the internal or external temperature reading exceeds a high-temperature limit (user programmable). The  $\overline{ALERT}$  interrupt output signal can be cleared by reading the status register(s) associated with the fault(s) or by successfully responding to an alert response address transmission by the master. In both cases, the alert is cleared but is reasserted at the end of the next conversion if the fault condition still exists. The interrupt does not halt automatic conversions. The  $\overline{ALERT}$  output is open-drain so that multiple devices can share a common interrupt line. All  $\overline{ALERT}$  interrupts can be masked using the configuration 2 register. The POR state of these registers is shown in Table 3.

# 7-Channel Precision Temperature Monitor with Beta Compensation

## **ALERT Response Address**

The SMBus alert response interrupt pointer provides quick fault identification for simple slave devices that lack the complex logic needed to be a bus master. Upon receiving an interrupt signal, the host master can broadcast a receive byte transmission to the alert response slave address (see the *Slave Address* section). Then, any slave device that generated an interrupt attempts to identify itself by putting its own address on the bus.

The alert response can activate several different slave devices simultaneously, similar to the I<sup>2</sup>C General Call. If more than one slave attempts to respond, bus arbitration rules apply, and the device with the lower address code wins. The losing device does not generate an acknowledgment and continues to hold the ALERT line low until cleared. (The conditions for clearing an alert vary depending on the type of slave device.) Successful completion of the alert response protocol clears the output latch. If the condition that caused the alert still exists, the MAX6693 reasserts the ALERT interrupt at the end of the next conversion.

## **OVERT Overtemperature Alarms**

The MAX6693 has four overtemperature registers that store remote alarm threshold data for the OVERT output. OVERT is asserted when a channel's measured temperature is greater than the value stored in the corresponding threshold register. OVERT remains asserted until the temperature drops below the programmed threshold minus 4°C hysteresis. An overtemperature output can be used to activate a cooling fan, send a warning, initiate clock throttling, or trigger a system shutdown to prevent component damage. See Table 3 for the POR state of the overtemperature threshold registers.

## **Command Byte Functions**

The 8-bit command byte register (Table 3) is the master index that points to the various other registers within the MAX6693. This register's POR state is 0000 0000.

## **Configuration Byte Functions**

There are three read-write configuration registers (Tables 4, 5, and 6) that can be used to control the MAX6693's operation.

## **Configuration 1 Register**

The configuration 1 register (Table 4) has several functions. Bit 7 (MSB) is used to put the MAX6693 either in software standby mode (STOP) or continuous conversion mode. Bit 6 resets all registers to their POR conditions and then clears itself. Bit 5 disables the SMBus timeout. Bit 3 enables resistance cancellation on channel 1. See the *Series Resistance Cancellation* section for more details. Bit 2 enables beta compensation on channel 1. See the *Beta Compensation* section for more details. The remaining bits of the configuration 1 register are not used. The POR state of this register is 0000 1100 (0Ch).

## **Configuration 2 Register**

The configuration 2 register functions are described in Table 5. Bits [6:0] are used to mask the ALERT interrupt output. Bit 6 masks the local alert interrupt and bits 5 through bit 0 mask the remote alert interrupts. The power-up state of this register is 0000 0000 (00h).

## **Configuration 3 Register**

Table 6 describes the configuration 3 register. Bits 5, 4, 3, and 0 mask the OVERT interrupt output for channels 6, 5, 4, and 1. The remaining bits, 7, 6, 2, and 1, are reserved. The power-up state of this register is 0000 0000 (00h).

## **Status Register Functions**

Status registers 1, 2, and 3 (Tables 7, 8, and 9) indicate which (if any) temperature thresholds have been exceeded and if there is an open-circuit or short-circuit fault detected with the external sense junctions. Status register 1 indicates if the measured temperature has exceeded the threshold limit set in the ALERT registers for the local or remote-sensing diodes. Status register 2 indicates if the measured temperature has exceeded the threshold limit set in the OVERT registers. Status register 3 indicates if there is a diode fault (open or short) in any of the remote-sensing channels.

Bits in the alert status register clear by a successful read, but set again after the next conversion unless the fault is corrected, either by a drop in the measured temperature or an increase in the threshold temperature.

The ALERT interrupt output follows the status flag bit. Once the ALERT output is asserted, it can be deasserted by either reading status register 1 or by successfully responding to an alert response address. In both cases, the alert is cleared even if the fault condi-

# 7-Channel Precision Temperature Monitor with Beta Compensation

**Table 3. Command Byte Register Bit Assignment**

REGISTER	ADDRESS (HEX)	POR STATE (HEX)	READ/ WRITE	DESCRIPTION
Local	07	00	R	Read local temperature register
Remote 1	01	00	R	Read channel 1 remote temperature register
Remote 2	02	00	R	Read channel 2 remote temperature register
Remote 3	03	00	R	Read channel 3 remote temperature register
Remote 4	04	00	R	Read channel 4 remote temperature register
Remote 5	05	00	R	Read channel 5 remote temperature register
Remote 6	06	00	R	Read channel 6 remote temperature register
Configuration 1	41	0C	R/W	Read/write configuration register 1
Configuration 2	42	00	R/W	Read/write configuration register 2
Configuration 3	43	00	R/W	Read/write configuration register 3
Status1	44	00	R	Read status register 1
Status2	45	00	R	Read status register 2
Status3	46	00	R	Read status register 3
Local $\overline{\text{ALERT}}$ High Limit	17	5A	R/W	Read/write local alert high-temperature threshold limit register
Remote 1 $\overline{\text{ALERT}}$ High Limit	11	6E	R/W	Read/write channel 1 remote-diode alert high-temperature threshold limit register
Remote 2 $\overline{\text{ALERT}}$ High Limit	12	7F	R/W	Read/write channel 2 remote-diode alert high-temperature threshold limit register
Remote 3 $\overline{\text{ALERT}}$ High Limit	13	64	R/W	Read/write channel 3 remote-diode alert high-temperature threshold limit register
Remote 4 $\overline{\text{ALERT}}$ High Limit	14	64	R/W	Read/write channel 4 remote-diode alert high-temperature threshold limit register
Remote 5 $\overline{\text{ALERT}}$ High Limit	15	64	R/W	Read/write channel 5 remote-diode alert high-temperature threshold limit register
Remote 6 $\overline{\text{ALERT}}$ High Limit	16	64	R/W	Read/write channel 6 remote-diode alert high-temperature threshold limit register
Remote 1 $\overline{\text{OVERT}}$ High Limit	21	6E	R/W	Read/write channel 1 remote-diode overtemperature threshold limit register
Remote 4 $\overline{\text{OVERT}}$ High Limit	24	7F	R/W	Read/write channel 4 remote-diode overtemperature threshold limit register
Remote 5 $\overline{\text{OVERT}}$ High Limit	25	5A	R/W	Read/write channel 5 remote-diode overtemperature threshold limit register
Remote 6 $\overline{\text{OVERT}}$ High Limit	26	5A	R/W	Read/write channel 6 remote-diode overtemperature threshold limit register
Remote 1 Extended Temperature	09	00	R	Read channel 1 remote-diode extended temperature register
Manufacturer ID	0A	4D	R	Read manufacturer ID

# 7-Channel Precision Temperature Monitor with Beta Compensation

**Table 4. Configuration 1 Register**

BIT	NAME	POR STATE	FUNCTION
7 (MSB)	STOP	0	Standby-Mode Control Bit. If STOP is set to logic 1, the MAX6693 stops converting and enters standby mode.
6	POR	0	Reset Bit. Set to logic 1 to put the device into its power-on state. This bit is self-clearing.
5	TIMEOUT	0	Timeout Enable Bit. Set to logic 0 to enable SMBus timeout.
4	RESERVED	0	Reserved. Must set to 0.
3	Resistance cancellation	1	Resistance Cancellation Bit. When set to logic 1, the MAX6693 cancels series resistance in the channel 1 thermal diode.
2	Beta compensation	1	Beta Compensation Bit. When set to logic 1, the MAX6693 compensates for low beta in the channel 1 thermal sensing transistor.
1	Reserved	0	—
0	Reserved	0	—

**Table 5. Configuration 2 Register**

BIT	NAME	POR STATE	FUNCTION
7 (MSB)	Reserved	0	—
6	Mask Local ALERT	0	Local Alert Mask. Set to logic 1 to mask local channel $\overline{\text{ALERT}}$ .
5	Mask ALERT 6	0	Channel 6 Alert Mask. Set to logic 1 to mask channel 6 $\overline{\text{ALERT}}$ .
4	Mask ALERT 5	0	Channel 5 Alert Mask. Set to logic 1 to mask channel 5 $\overline{\text{ALERT}}$ .
3	Mask ALERT 4	0	Channel 4 Alert Mask. Set to logic 1 to mask channel 4 $\overline{\text{ALERT}}$ .
2	Mask ALERT 3	0	Channel 3 Alert Mask. Set to logic 1 to mask channel 3 $\overline{\text{ALERT}}$ .
1	Mask ALERT 2	0	Channel 2 Alert Mask. Set to logic 1 to mask channel 2 $\overline{\text{ALERT}}$ .
0	Mask ALERT 1	0	Channel 1 Alert Mask. Set to logic 1 to mask channel 1 $\overline{\text{ALERT}}$ .

tion exists, but the  $\overline{\text{ALERT}}$  output reasserts at the end of the next conversion. The bits indicating the fault for the  $\overline{\text{OVERT}}$  interrupt output clear only on reading the status 2 register even if the fault conditions still exist. Reading the status 2 register does not clear the  $\overline{\text{OVERT}}$  interrupt output. To eliminate the fault condition, either the measured temperature must drop below the temperature threshold minus the hysteresis value (4°C), or the trip temperature must be set at least 4°C above the current temperature.

## Applications Information

### Remote-Diode Selection

The MAX6693 directly measures the die temperature of CPUs and other ICs that have on-chip temperature-sensing diodes (see the *Typical Application Circuit*) or it can measure the temperature of a discrete diode-connected transistor.

### Effect of Ideality Factor

The accuracy of the remote temperature measurements depends on the ideality factor ( $n$ ) of the remote “diode” (actually a transistor). The MAX6693 is optimized for  $n = 1.006$  (channel 1) and  $n = 1.008$  (channels 2–6). A thermal diode on the substrate of an IC is normally a pnp with the base and emitter brought out to the collector (diode connection) grounded. DXP\_ must be connected to the anode (emitter) and DXN\_ must be connected to the cathode (base) of this pnp. If a sense transistor with an ideality factor other than 1.006 or 1.008 is used, the output data is different from the data obtained with the optimum ideality factor. Fortunately, the difference is predictable. Assume a remote-diode sensor designed for a nominal ideality factor  $n_{\text{NOMINAL}}$  is used to measure the temperature of a diode with a different ideality factor  $n_1$ . The measured temperature  $T_M$  can be corrected using:

# 7-Channel Precision Temperature Monitor with Beta Compensation

Table 6. Configuration 3 Register

BIT	NAME	POR STATE	FUNCTION
7 (MSB)	Reserved	0	—
6	Reserved	0	—
5	Mask OVERT 6	0	Channel 6 Remote-Diode $\overline{\text{OVERT}}$ Mask Bit. Set to logic 1 to mask channel 6 $\overline{\text{OVERT}}$ .
4	Mask OVERT 5	0	Channel 5 Remote-Diode $\overline{\text{OVERT}}$ Mask Bit. Set to logic 1 to mask channel 5 $\overline{\text{OVERT}}$ .
3	Mask OVERT 4	0	Channel 4 Remote-Diode $\overline{\text{OVERT}}$ Mask Bit. Set to logic 1 to mask channel 4 $\overline{\text{OVERT}}$ .
2	Reserved	0	—
1	Reserved	0	—
0	Mask OVERT 1	0	Channel 1 Remote-Diode $\overline{\text{OVERT}}$ Mask Bit. Set to logic 1 to mask channel 1 $\overline{\text{OVERT}}$ .

$$T_M = T_{\text{ACTUAL}} \left( \frac{n_1}{n_{\text{NOMINAL}}} \right)$$

where temperature is measured in Kelvin and  $n_{\text{NOMINAL}}$  for channel 1 of the MAX6693 is 1.009. As an example, assume you want to use the MAX6693 with a CPU that has an ideality factor of 1.002. If the diode has no series resistance, the measured data is related to the real temperature as follows:

$$T_{\text{ACTUAL}} = T_M \times \left( \frac{n_{\text{NOMINAL}}}{n_1} \right) = T_M \times \left( \frac{1.009}{1.002} \right) = T_M (1.00699)$$

For a real temperature of +85°C (358.15K), the measured temperature is +84.41°C (357.56K), an error of -0.590°C.

### Series Resistance Cancellation

Some thermal diodes on high-power ICs can have excessive series resistance, which can cause temperature measurement errors with conventional remote temperature sensors. Channel 1 of the MAX6693 has a series resistance cancellation feature (enabled by bit 3 of the configuration 1 register) that eliminates the effect of diode series resistance. Set bit 3 to 1 if the series resistance is large enough to affect the accuracy of channel 1. The series resistance cancellation function increases the conversion time for channel 1 by 125ms. This feature cancels the bulk resistance of the sensor and any other resistance in series (wire, contact resistance, etc.). The cancellation range is from 0Ω to 100Ω.

### Beta Compensation

The MAX6693 is optimized for use with a substrate PNP remote-sensing transistor on the die of the target IC. DXP1 connects to the emitter of the sensing transistor and DXN1 connects to the base. The collector is grounded. Such transistors can have very low beta (less than 1) when built in processes with 65nm and smaller geometries. Because of the very low beta, standard “remote diode” temperature sensors may exhibit large errors when used with these transistors. Channel 1 of the MAX6693 incorporates a beta compensation function that, when enabled, eliminates the effect of low beta values. This function is enabled at power-up using bit 2 of the configuration 1 register. Whenever low beta compensation is enabled, series-resistance cancellation must be enabled.

### Discrete Remote Diodes

When the remote-sensing diode is a discrete transistor, its collector and base must be connected together. Table 10 lists examples of discrete transistors that are appropriate for use with the MAX6693. The transistor must be a small-signal type with a relatively high forward voltage; otherwise, the A/D input voltage range can be violated. The forward voltage at the highest expected temperature must be greater than 0.25V at 10μA, and at the lowest expected temperature, the forward voltage must be less than 0.95V at 100μA. Large power transistors must not be used. Also, ensure that the base resistance is less than 100Ω. Tight specifications for forward current gain ( $50 < \beta < 150$ , for example) indicate that the manufacturer has good process controls and that the devices have consistent  $V_{BE}$  char-



# 7-Channel Precision Temperature Monitor with Beta Compensation

**Table 7. Status 1 Register**

BIT	NAME	POR STATE	FUNCTION
7 (MSB)	Reserved	0	—
6	Local ALERT	0	Local Channel High-Alert Bit. This bit is set to logic 1 when the local temperature exceeds the temperature threshold limit in the local ALERT high-limit register.
5	Remote 6 ALERT	0	Channel 6 Remote-Diode High-Alert Bit. This bit is set to logic 1 when the channel 6 remote-diode temperature exceeds the temperature threshold limit in the remote 6 ALERT high-limit register.
4	Remote 5 ALERT	0	Channel 5 Remote-Diode High-Alert Bit. This bit is set to logic 1 when the channel 5 remote-diode temperature exceeds the programmed temperature threshold limit in the remote 5 ALERT high-limit register.
3	Remote 4 ALERT	0	Channel 4 Remote-Diode High-Alert Bit. This bit is set to logic 1 when the channel 4 remote-diode temperature exceeds the temperature threshold limit in the remote 4 ALERT high-limit register.
2	Remote 3 ALERT	0	Channel 3 Remote-Diode High-Alert Bit. This bit is set to logic 1 when the channel 3 remote-diode temperature exceeds the programmed temperature threshold limit in the remote 3 ALERT high-limit register.
1	Remote 2 ALERT	0	Channel 2 Remote-Diode High-Alert Bit. This bit is set to logic 1 when the channel 2 remote-diode temperature exceeds the temperature threshold limit in the remote 2 ALERT high-limit register.
0	Remote 1 ALERT	0	Channel 1 Remote-Diode High-Alert Bit. This bit is set to logic 1 when the channel 1 remote-diode temperature exceeds the temperature threshold limit in the remote 1 ALERT high-limit register.

acteristics. Manufacturers of discrete transistors do not normally specify or guarantee ideality factor. This is normally not a problem since good-quality discrete transistors tend to have ideality factors that fall within a relatively narrow range. We have observed variations in remote temperature readings of less than  $\pm 2^{\circ}\text{C}$  with a variety of discrete transistors. Still, it is good design practice to verify good consistency of temperature readings with several discrete transistors from any manufacturer under consideration.

### Unused Diode Channels

If one or more of the remote diode channels is not needed, disconnect the DXP and DXN inputs for that channel, or connect the DXP input to  $V_{CC}$ . The status register indicates a diode "fault" for this channel and the channel is ignored during the temperature-measurement sequence. It is also good practice to mask any

unused channels immediately upon power-up by setting the appropriate bits in the Configuration 2 and Configuration 3 registers. This will prevent unused channels from causing  $\overline{\text{ALERT}}$  or  $\overline{\text{OVERT}}$  to assert.

### Thermal Mass and Self-Heating

When sensing local temperature, the MAX6693 measures the temperature of the PCB to which it is soldered. The leads provide a good thermal path between the PCB traces and the die. As with all IC temperature sensors, thermal conductivity between the die and the ambient air is poor by comparison, making air temperature measurements impractical. Because the thermal mass of the PCB is far greater than that of the MAX6693, the device follows temperature changes on the PCB with little or no perceivable delay. When measuring the temperature of a CPU or other IC with an on-chip sense junction, thermal mass has virtually no

# 7-Channel Precision Temperature Monitor with Beta Compensation

**Table 8. Status 2 Register**

BIT	NAME	POR STATE	FUNCTION
7 (MSB)	Reserved	0	—
6	Reserved	0	—
5	Remote 6 OVERT	0	Channel 6 Remote-Diode Overtemperature Status Bit. This bit is set to logic 1 when the channel 6 remote-diode temperature exceeds the temperature threshold limit in the remote 6 OVERT high-limit register.
4	Remote 5 OVERT	0	Channel 5 Remote Diode Overtemperature Status Bit. This bit is set to logic 1 when the channel 5 remote-diode temperature exceeds the temperature threshold limit in the remote 5 OVERT high-limit register.
3	Remote 4 OVERT	0	Channel 4 Remote Diode Overtemperature Status Bit. This bit is set to logic 1 when the channel 4 remote-diode temperature exceeds the temperature threshold limit in the remote 4 OVERT high-limit register.
2	Reserved	0	—
1	Reserved	0	—
0	Remote 1 OVERT	0	Channel 1 Remote-Diode Overtemperature Status Bit. This bit is set to logic 1 when the channel 1 remote-diode temperature exceeds the temperature threshold limit in the remote 1 OVERT high-limit register.

**Table 9. Status 3 Register**

BIT	NAME	POR STATE	FUNCTION
7 (MSB)	Reserved	0	—
6	Diode fault 6	0	Channel 6 Remote-Diode Fault Bit. This bit is set to 1 when DXP6 and DXN6 are open circuit or when DXP6 is connected to V <sub>CC</sub> .
5	Diode fault 5	0	Channel 5 Remote-Diode Fault Bit. This bit is set to 1 when DXP5 and DXN5 are open circuit or when DXP5 is connected to V <sub>CC</sub> .
4	Diode fault 4	0	Channel 4 Remote-Diode Fault Bit. This bit is set to 1 when DXP4 and DXN4 are open circuit or when DXP4 is connected to V <sub>CC</sub> .
3	Diode fault 3	0	Channel 3 Remote-Diode Fault Bit. This bit is set to 1 when DXP3 and DXN3 are open circuit or when DXP3 is connected to V <sub>CC</sub> .
2	Diode fault 2	0	Channel 2 Remote-Diode Fault Bit. This bit is set to 1 when DXP2 and DXN2 are open circuit or when DXP2 is connected to V <sub>CC</sub> .
1	Diode fault 1	0	Channel 1 Remote-Diode Fault Bit. This bit is set to 1 when DXP1 and DXN1 are open circuit or when DXP1 is connected to V <sub>CC</sub> .
0	Reserved	0	—



# 7-Channel Precision Temperature Monitor with Beta Compensation

effect; the measured temperature of the junction tracks the actual temperature within a conversion cycle.

When measuring temperature with discrete remote transistors, the best thermal response times are obtained with transistors in small packages (i.e., SOT23 or SC70). Take care to account for thermal gradients between the heat source and the sensor, and ensure that stray air currents across the sensor package do not interfere with measurement accuracy. Self-heating does not significantly affect measurement accuracy. Remote-sensor self-heating due to the diode current source is negligible.

### ADC Noise Filtering

The integrating ADC has good noise rejection for low-frequency signals, such as power-supply hum. In environments with significant high-frequency EMI, connect an external 100pF capacitor between DXP\_ and DXN\_. Larger capacitor values can be used for added filtering, but do not exceed 100pF because it can introduce errors due to the rise time of the switched current source. High-frequency noise reduction is needed for high-accuracy remote measurements. Noise can be reduced with careful PCB layout as discussed in the *PCB Layout* section.

### Slave Address

The slave address for the MAX6693 is shown in Table 11.

**Table 10. Remote-Sensors Transistor Manufacturer (for Channels 2–6)**

MANUFACTURER	MODEL NO.
Central Semiconductor (USA)	CMPT3904
Rohm Semiconductor (USA)	SST3904
Samsung (Korea)	KST3904-TF
Siemens (Germany)	SMBT3904
Zetex (England)	FMMT3904CT-ND

**Note:** Discrete transistors must be diode connected (base shorted to collector).

**Table 11. Slave Address**

DEVICE ADDRESS							
A7	A6	A5	A4	A3	A2	A1	A0
1	0	0	1	1	0	1	R/W

### PCB Layout

Follow these guidelines to reduce the measurement error when measuring remote temperature:

- 1) Place the MAX6693 as close as is practical to the remote diode. In noisy environments, such as a computer motherboard, this distance can be 4in to 8in (typ). This length can be increased if the worst noise sources are avoided. Noise sources include CRTs, clock generators, memory buses, and PCI buses.
- 2) Do not route the DXP-DXN lines next to the deflection coils of a CRT. Also, do not route the traces across fast digital signals, which can easily introduce +30°C error, even with good filtering.
- 3) Route the DXP and DXN traces in parallel and in close proximity to each other. Each parallel pair of traces should go to a remote diode. Route these traces away from any higher voltage traces, such as +12VDC. Leakage currents from PCB contamination must be dealt with carefully since a 20MΩ leakage path from DXP to ground causes about +1°C error. If high-voltage traces are unavoidable, connect guard traces to GND on either side of the DXP-DXN traces (Figure 5).
- 4) Route through as few vias and crossunders as possible to minimize copper/solder thermocouple effects.
- 5) Use wide traces when practical. 5mil to 10mil traces are typical. Be aware of the effect of trace resistance on temperature readings when using long, narrow traces.
- 6) When the power supply is noisy, add a resistor (up to 47Ω) in series with V<sub>CC</sub>.

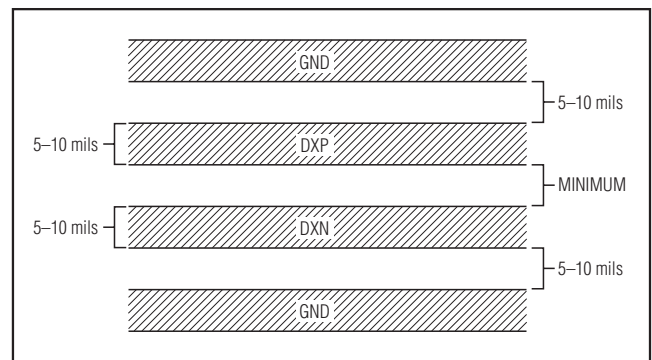

Figure 5. Recommended DXP-DXN PCB Traces. The two outer guard traces are recommended if high-voltage traces near the DXN and DXP traces.

# 7-Channel Precision Temperature Monitor with Beta Compensation

## Twisted-Pair and Shielded Cables

Use a twisted-pair cable to connect the remote sensor for remote-sensor distances longer than 8in or in very noisy environments. Twisted-pair cable lengths can be between 6ft and 12ft before noise introduces excessive errors. For longer distances, the best solution is a shielded twisted pair like that used for audio microphones. For example, Belden #8451 works well for distances up to 100ft in a noisy environment. At the

device, connect the twisted pair to DXP and DXN and the shield to GND. Leave the shield unconnected at the remote sensor. For very long cable runs, the cable's parasitic capacitance often provides noise filtering, so the 100pF capacitor can often be removed or reduced in value. Cable resistance also affects remote-sensor accuracy. For every  $1\Omega$  of series resistance the error is approximately  $+0.5^\circ\text{C}$ .

## Pin Configuration

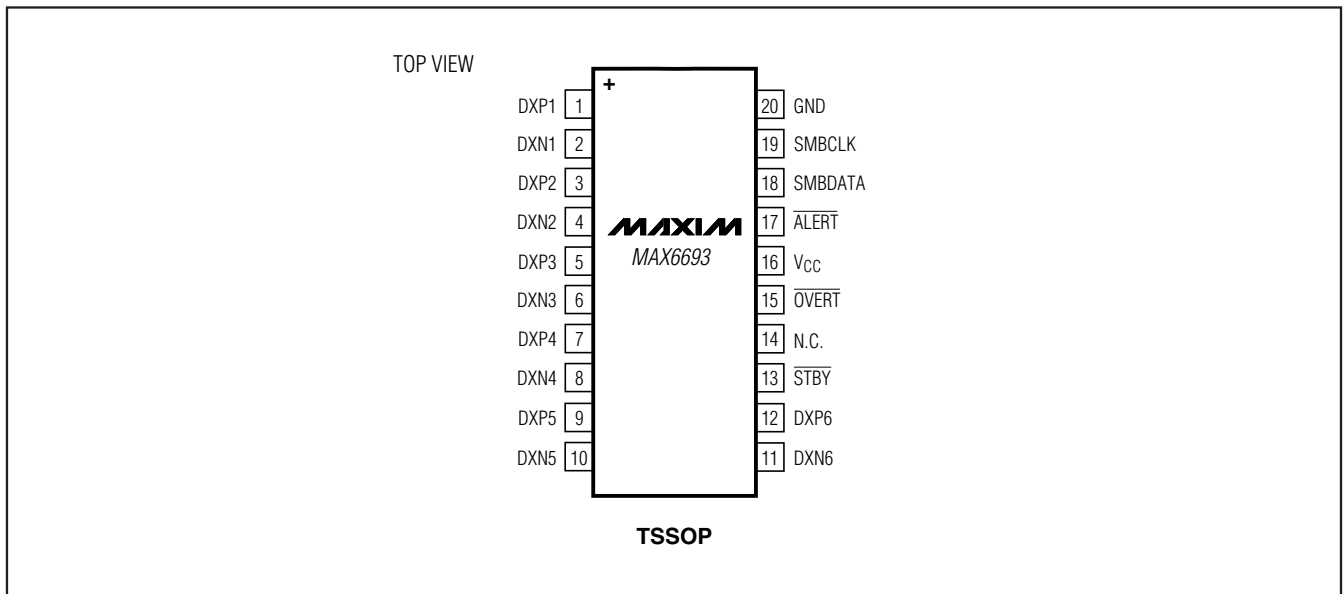

## Chip Information

PROCESS: BiCMOS

# 7-Channel Precision Temperature Monitor with Beta Compensation

## Package Information

For the latest package outline information, go to [www.maxim-ic.com/packages](http://www.maxim-ic.com/packages).

PACKAGE TYPE	PACKAGE CODE	DOCUMENT NO.
20 TSSOP	U20-2	<a href="#">21-0066</a>

**MAX6693**

*Maxim cannot assume responsibility for use of any circuitry other than circuitry entirely embodied in a Maxim product. No circuit patent licenses are implied. Maxim reserves the right to change the circuitry and specifications without notice at any time.*

**Maxim Integrated Products, 120 San Gabriel Drive, Sunnyvale, CA 94086 408-737-7600** \_\_\_\_\_ 19

## X-ON Electronics

Largest Supplier of Electrical and Electronic Components

*Click to view similar products for [Board Mount Temperature Sensors](#) category:*

*Click to view products by [Maxim](#) manufacturer:*

Other Similar products are found below :

[5962-8757102XA](#) [66F115](#) [EMC1063-1-ACZL-TR](#) [NCT218FCT2G](#) [O53GAB175A-160Y](#) [3610085020002](#) [389049M9527](#) [MIKROE-912](#)  
[ADM1023ARQZ-REEL](#) [ADM1032ARMZ-1RL](#) [AT30TS74-U1FMBB-T](#) [AT30TS74-U1FMAB-T](#) [AT30TS74-U1FMCB-T](#) [AT30TS74-](#)  
[U1FMDB-T](#) [ADT7483AARQZ-RL](#) [ADT7481ARMZ-REEL](#) [ADT7463ARQZ-REEL](#) [MCP98243T-BE/MC](#) [66L080-0226](#) [5962-8757103XA](#)  
[S-58LM20A-I4T1U](#) [NCT375MNR2G](#) [LM84CIMQA](#) [CAT34TS00VP2GT4A](#) [NCT80DBR2G](#) [SEN-16304](#) [GX21M15](#) [GX122](#) [NST175H-](#)  
[QSPR](#) [TC6501P065VCTTR](#) [AT-1U](#) [MCP9700AT-E/LT](#) [MCP9701-E/TO](#) [MCP9803-M/MS](#) [MCP9701A-E/TO](#) [LM57FEPWQ1](#) [LM57FPW](#)  
[LM57FSPWQ1](#) [60-41123102-0150.0010](#) [60-43123102-0150.0010](#) [60-53123102-0150.0010](#) [MLX90615SSG-DAA-000-TU](#) [TMP303CDRLR](#)  
[TC6501P055VCTTR](#) [TC6503P005VCTTR](#) [ADT7311WTRZ-RL](#) [ADT7311WTRZ-RL7](#) [ADT7473ARQZ-REEL](#) [LM335AM](#)  
[LM335AM/NOPB](#)