

## General Description

The MAX71020AEVK1# evaluation kit (EV kit) demonstrates the capabilities of the MAX71020A embedded energy measurement (EM) device. The EVK can measure AC and/or DC current and voltage utilizing a surface mount resistive shunt and resistive voltage divider.

The EV kit provides an isolated SPI interface to the device over USB. A provided Windows® graphical user interface (GUI) handles translation from the USB to device-specific SPI protocols.

## Benefits and Features

- Allows Evaluation of the MAX71020A Embedded Energy Measurement Device in a Safe and Simple Manner
  - Isolated SPI/USB for User Safety
  - Windows Graphical User Interface (GUI) Handles All Common Tasks
  - Easy Hook Up to Test Equipment or Other Test Environments
  - Fully Assembled and Tested
  - Precalibrated with Utility Meter Grade Equipment
- Highly Accurate AFE for Testing
  - AC 2000:1 Dynamic Current Range at 0.5% Accuracy
  - DC Voltage and/or Current Measurement

### SAFETY AND ESD NOTES



**THE DEMO SYSTEM IS ESD SENSITIVE! TAKE ESD PRECAUTIONS WHEN HANDLING THE DEMO BOARD! CONNECTING LIVE VOLTAGES TO THE DEMO BOARD SYSTEM WILL RESULT IN POTENTIALLY HAZARDOUS VOLTAGES ON THE DEMO BOARD.**



**TAKE EXTREME CAUTION WHEN HANDLING THE DEMO BOARD AFTER IT IS CONNECTED TO LIVE VOLTAGES! BOARD GROUND IS DIRECTLY CONNECTED TO LINE VOLTAGE! ANY TEST EQUIPMENT CONNECTED TO THE DEMO BOARD WHEN THE BOARD IS CONNECTED TO LIVE VOLTAGES MUST BE ELECTRICALLY ISOLATED FROM THE AC MAINS. FAILURE TO OBSERVE THIS MAY RESULT IN DESTRUCTION OF THE DEMO BOARD AND THE TEST EQUIPMENT, AND IN PERSONAL INJURY OR DEATH.**

### EV Kit Contents

- 1x MAX71020 EM REV 3 evaluation board
- 1x USB A to B cable
- USB flash drive with relevant collateral



### Connection and Jumper Descriptions

The PCB has several jumpers and connections to allow measurement and communication with an external host.

**Table 1. Connections and Jumpers**

NAME	DEFAULT	DESCRIPTION
J1	1-2	Selects isolated USB power (1-2 default) supply
J17	1-2	SCK connection jumper
J18	1-2	MOSI connection jumper
J19	1-2	SSB connection jumper
J20	1-2	MISO connection jumper
J54	1-2	Grounds VB/XTEMP
J57	1-2	Connects neutral AC current source to Neutral AC voltage source
J58	1-2	Grounds IBP/DC reference
J59	1-2	Grounds IBN/DC reference
J56	N/A	Neutral AC current-source connection
J55	N/A	Neutral AC current load connection
J49	N/A	Neutral AC voltage source connection (optional)
J50	N/A	Line AC voltage connection
J16	N/A	External isolated SPI headers
J60	N/A	MAX71020 DIO headers

MAX71020A PCB Layout

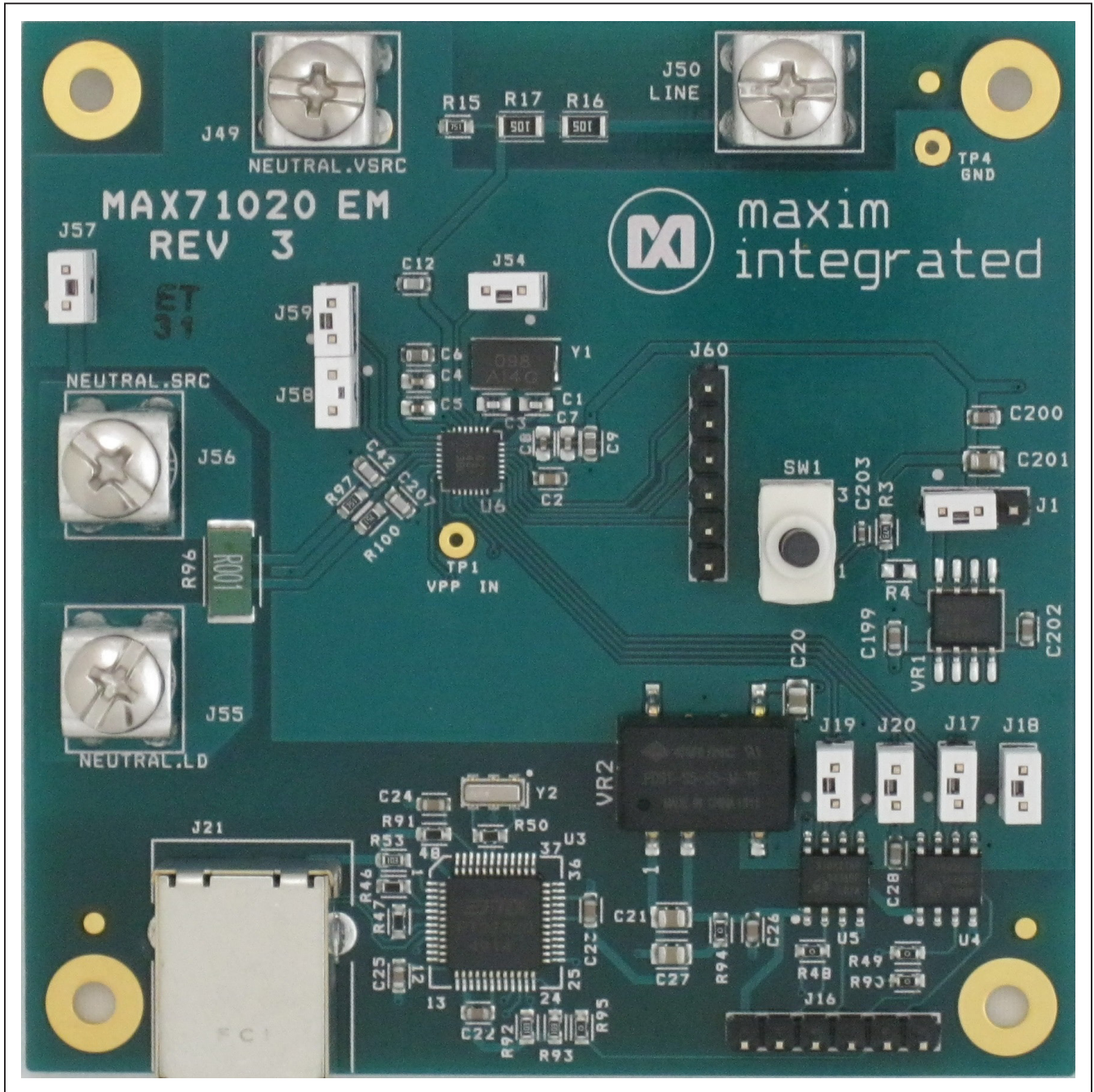

### Block Diagram

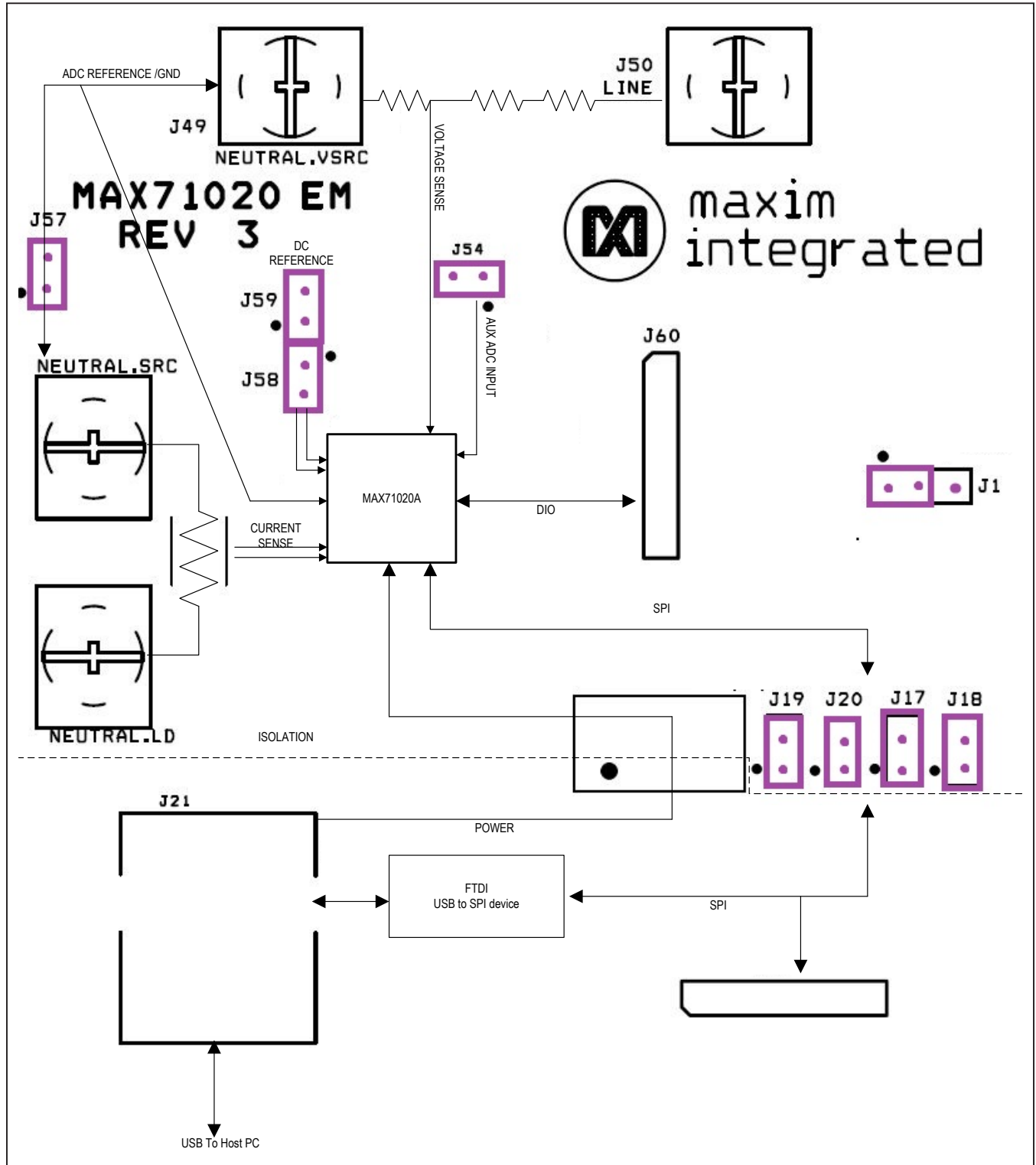

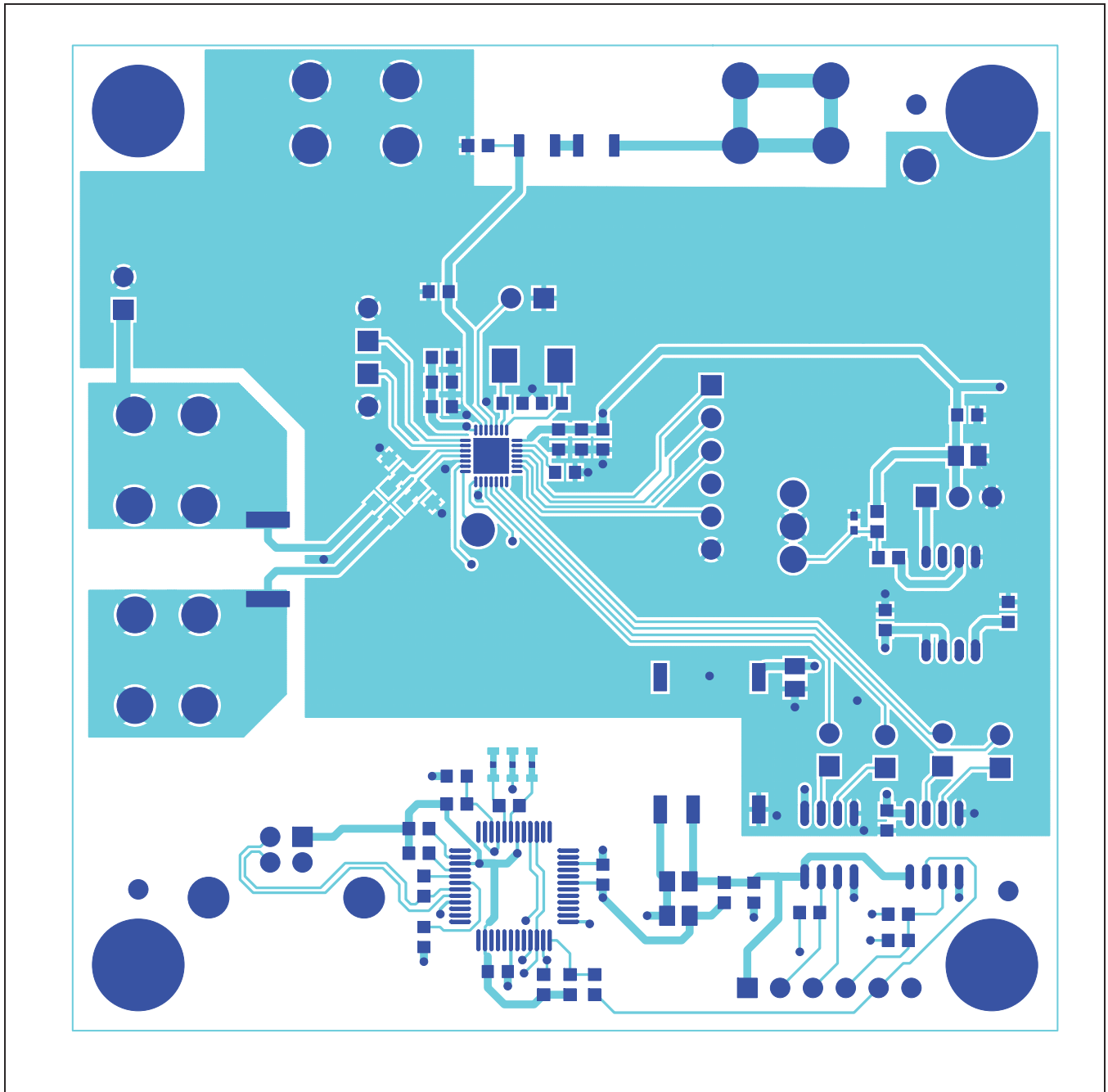

Figure 1. MAX71020A EV Board Layout—Top Layer

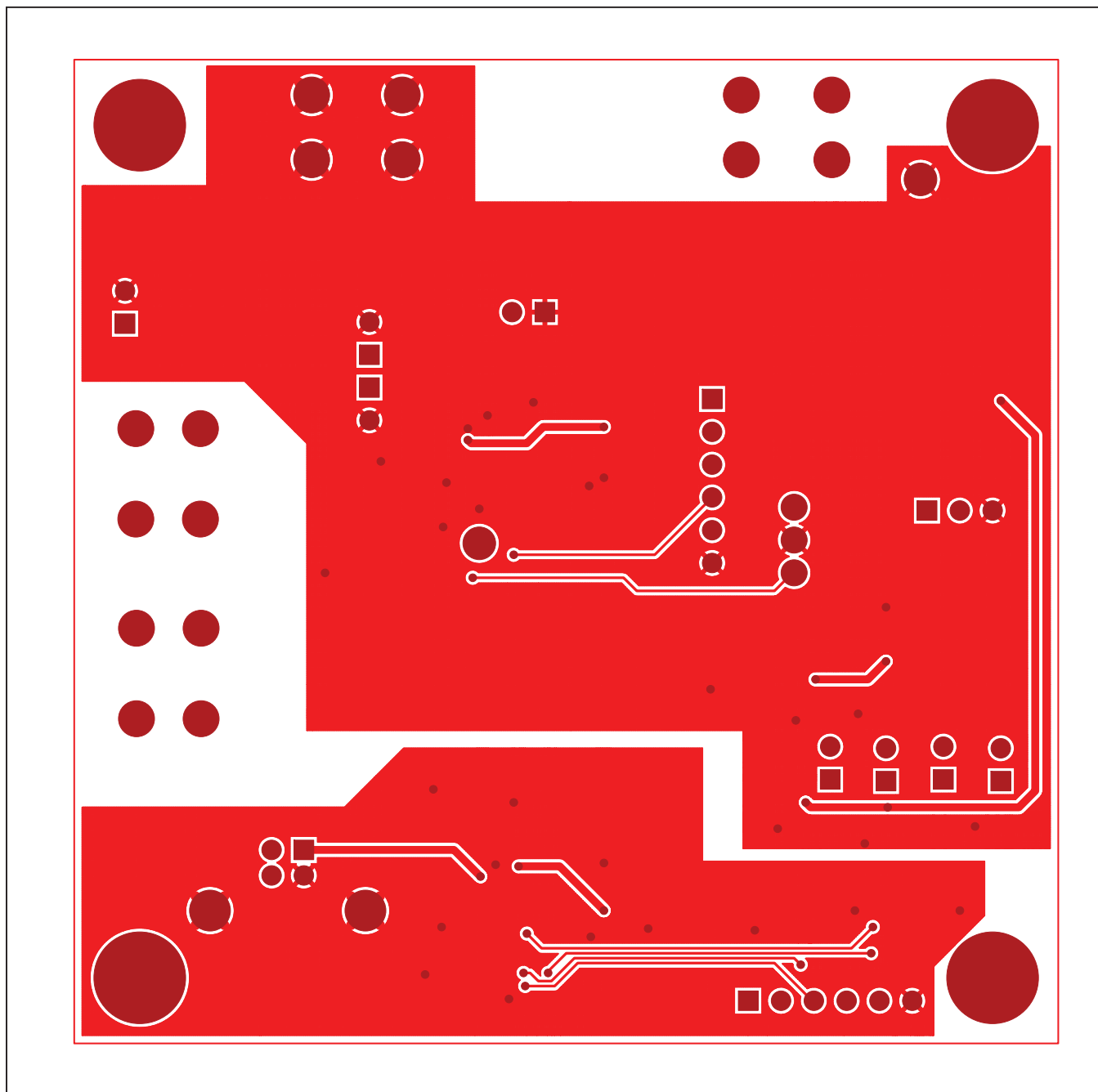

Figure 2. MAX71020A EV Board Layout—Bottom Layer

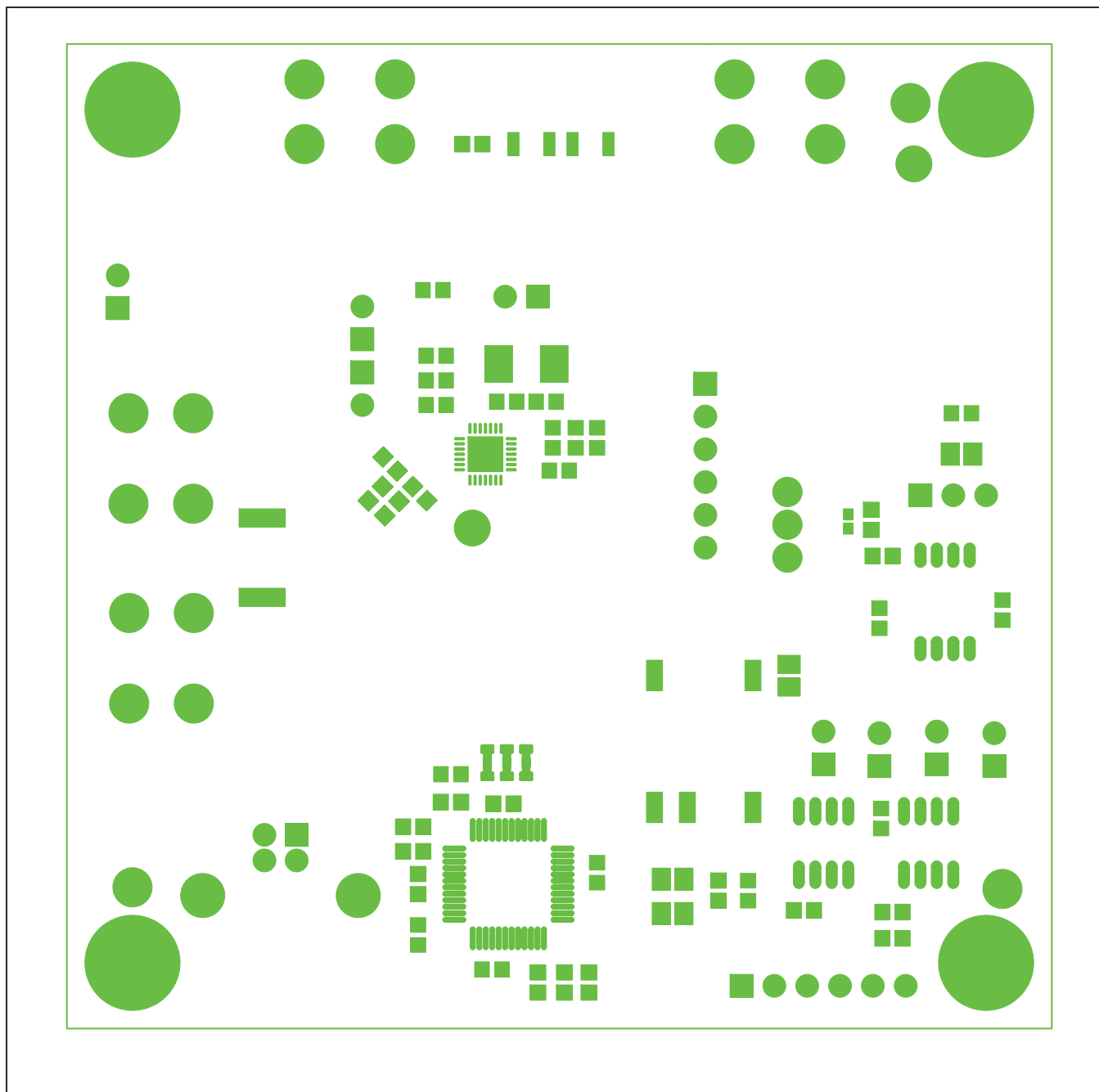

Figure 3. MAX71020A EV Board Layout—Top Soldermask

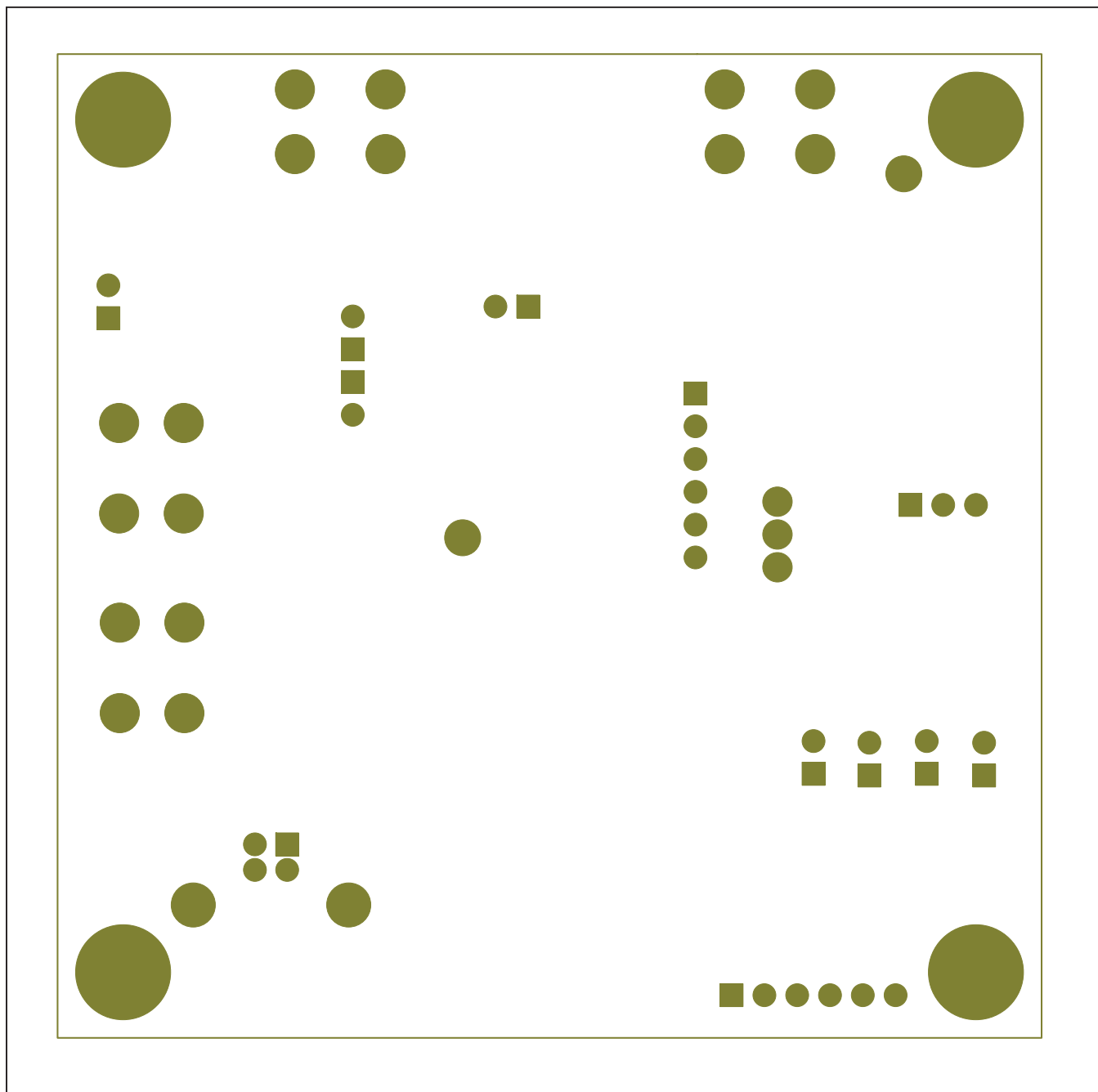

Figure 4. MAX71020A EV Board Layout—Bottom Soldermask



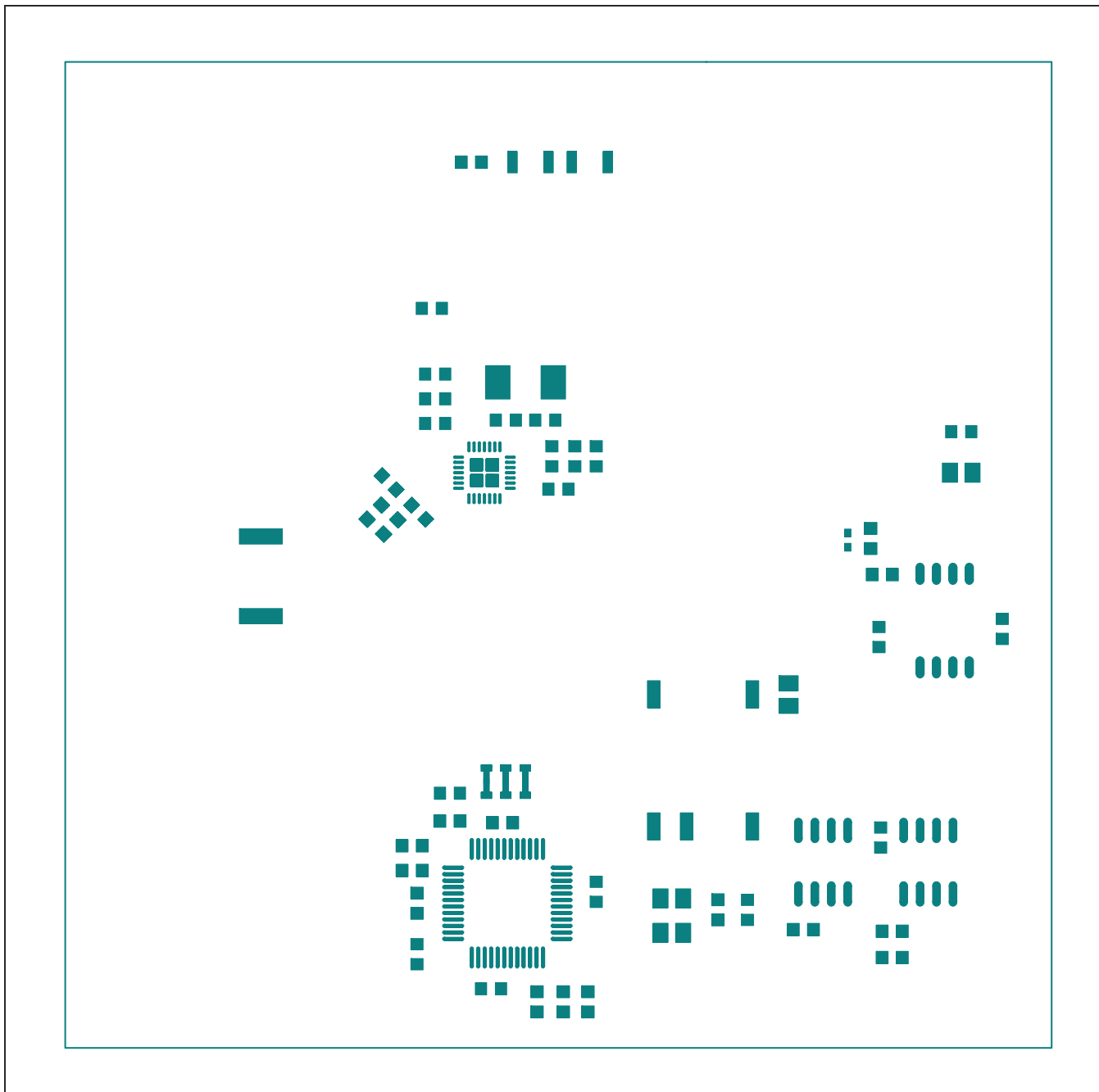

Figure 5. MAX71020A EV Board Layout—Solder Paste Top

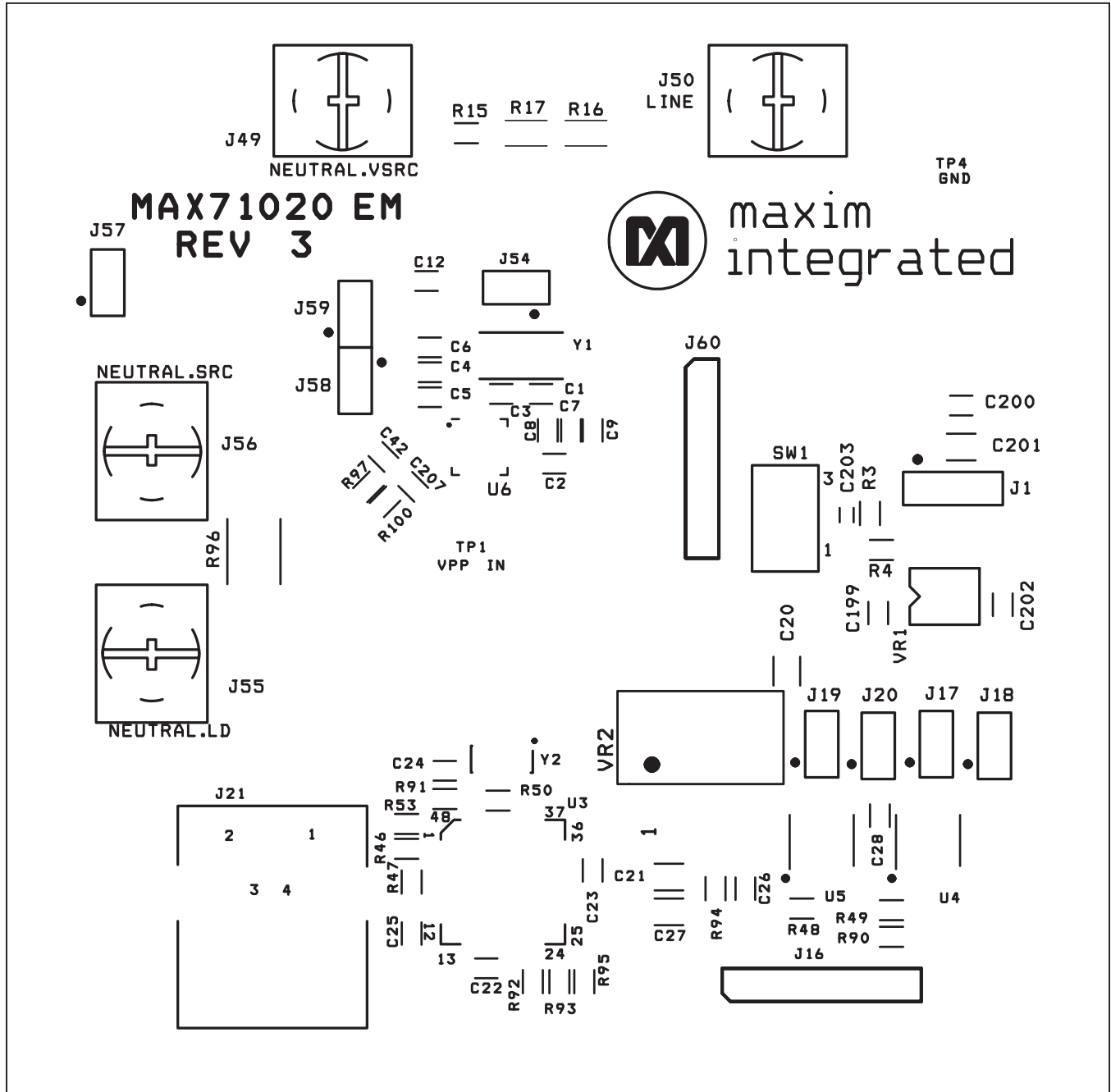

Figure 6. MAX71020A EV Board Layout—Top Silkscreen

DRILL CHART				
SYM	DIAM	TOL	QTY	NOTE
x	0.012	+/- .003	48	
+	0.037	+/- .003	35	
◇	0.040	+/- .003	2	
⊠	0.042	+/- .003	3	
⊞	0.073	+/- .003	16	
○	0.091	+/- .003	2	
△	0.125	+/- .003	4	
TOTAL			110	

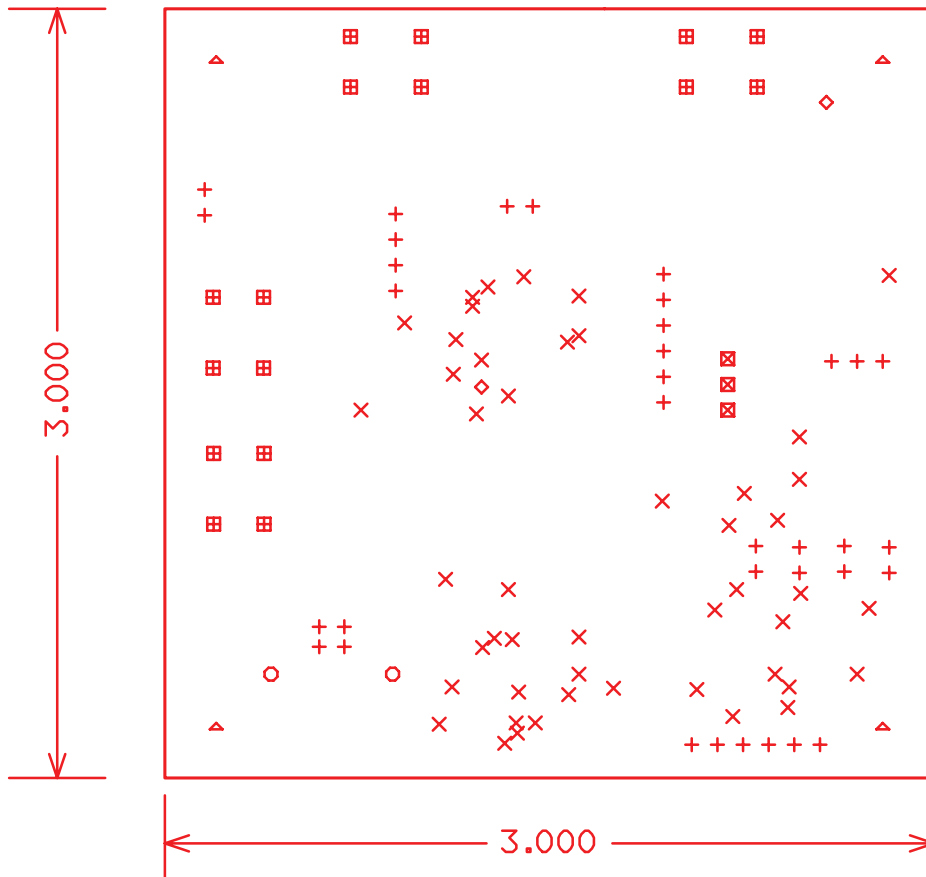

Figure 7. MAX71020A EV Board Layout—TBD

### Component Information and Schematics

See the following links for component information and schematics:

- [MAX71020AEVKIT1# BOM](#)
- [MAX71020AEVKIT1# Schematic](#)

### Ordering Information

PART	TYPE
MAX71020AEVK1#	EV kit

#Denotes RoHS compliant.

## Revision History

REVISION NUMBER	REVISION DATE	DESCRIPTION	PAGES CHANGED
0	6/15	Initial release	—

For pricing, delivery, and ordering information, please contact Maxim Direct at 1-888-629-4642, or visit Maxim Integrated's website at [www.maximintegrated.com](http://www.maximintegrated.com).

*Maxim Integrated cannot assume responsibility for use of any circuitry other than circuitry entirely embodied in a Maxim Integrated product. No circuit patent licenses are implied. Maxim Integrated reserves the right to change the circuitry and specifications without notice at any time.*

Bill of Materials (BOM) (Rev 0, 6/15)											
Item	Quantity	Reference	Part	Footprint	DigiKeyPN	Manufacturer	ManufacturerPN	Tolerance	Rating	HDR	DNP
1	2	C1,C3	30pF	CC0402_RLP100-N	490-7755-1-ND	Murata	GRM1555C1H330GA01J	±5%	50V		
2	9	C2,C22,C23,C24,C26,C28,C199,C200,C202	0.1uF		603 445-1314-1-ND	TDK	C1608X7R1H104K080AA	±10%	50V		
3	2	C4,C7	1000pF	CC0402_RLP100-N	490-6366-1-ND	Murata	GRM155R72A102KA01D	±10%	100V		
4	2	C5,C8	0.1uF	CC0402_RLP100-N	445-5942-2-ND	TDK	C1005X5R1H104K050B8	±10%	50V		
5	2	C6,C9	10uF	CC0603_RLP132-N	587-1256-1-ND	Taiyo Yuden	JMK107BJ106MA-T	±10%	6.3V		
6	3	C12,C42,C207	1000pF		603 490-1451-1-ND	Murata	GRM1885C1H102JA01D				
7	4	C20,C21,C27,C201	10uF		805 490-3340-2-ND	Murata	GRM219R60J106KE19D	10%	6.3V		
8	1	C25	0.033uF		603 445-5093-1-ND	TDK	C1608X7R1H333K080AA	±10%	50V		
9	1	C203	0.1uF	CAPC1005(0402)56N	445-5942-2-ND	TDK	C1005X5R1H104K050B8	±10%	50V		
10	1	J1	CON3	SIP100P3	S1012E-36-ND	Sullins	PBC365AAN				3
11	1	J16	CON6	SIP100P6	S1012E-36-ND	Sullins	PBC365AAN				6
12	5	J17,J18,J19,J20,J57	CON2	SIP100P2	S1012E-36-ND	Sullins	PBC365AAN				2
13	1	J21	CON6	USBB	609-3657-ND	FCI	61729-1011BLF				
14	4	J49,J50,J55,J56	CON4	STERM	8191K-ND	KEYSTONE	8191				
15	1	J54	CON2		S1012E-36-ND	Sullins	PBC365AAN				2
16	2	J58,J59	CON2	SIP/1C/2P	S1012E-36-ND	Sullins	PBC365AAN				2
17	1	J60	CON6	SIP/6P	S1012E-36-ND	Sullins	PBC365AAN				6
18	1	R3	47K		603 P47KGCT-ND	Panasonic	ERJ-3GEYJ473V				
19	1	R4	NC		603						x
20	1	R15	750 0.1%		603 P750DBTR-ND	Panasonic	ERA-3AEB751V				
21	2	R16,R17	1M 0.1%	1206W		Panasonic	ERA-8AEB105V				
22	2	R46,R47	2.2K		603 P2.20KHCT-ND	Panasonic	ERJ-3EKF2201V				
23	5	R48,R49,R90,R94,R95		0	603 P0.0GCT-ND	Panasonic	ERJ-3GEYR000V				
24	1	R50	1M		603 P1.00MHCT-ND	Panasonic	ERJ-3EKF1004V				
25	3	R53,R92,R93	10K		603 P10KGCT-ND	Panasonic	ERJ-3GEYJ103V				
26	1	R91		470	603 P470HCT-ND	Panasonic	ERJ-3EKF4700V				
27	1	R96	0.001 1% 2.5W	2512P	696-1185-1-ND	RIEDON	CSR2512COR001F				
28	2	R97,R100	750 1%		603 P750DBTR-ND	Panasonic	ERA-3AEB751V				
29	1	SW1		PUSHBUTTON	EP11	C & K	EP11SD1CBE				
30	2	TP1,TP4		TP	TP_500X_MINITURE						x
31	1	U3	FT2232C	TQFP48	768-1010-1-ND	FTDI	FT2232D				
32	1	U4	S18420	ADUM3201	336-1753-5-ND	Silicon Labs	S18420AB-D-IS				
33	1	U5	S18421	ADUM3201	336-1755-5-ND	Silicon Labs	S18421AB-D-IS				
34	1	U6	71020 TQFN	28TQFN	MAX71020AETI+-ND	Maxim	MAX71020AETI+				
35	1	VR1	MAX5091BASA+	SOIC8	MAX5091BASA+-ND	Maxim	MAX5091BASA+				
36	1	VR2	VBT1-5V	VBT1	102-2688-1-ND	CUI Inc	PDS1-S5-S5-M-TR				
37	1	Y1	9.8304 MHz	XTAL_ABM7_6x3-5	535-9832-1-ND	Abracon	ABM7-9.8304MHZ-D-2-Y-T		30ppm		
38	1	Y2	CSTCR6M00	CSTCR	490-1204-1-ND	Murata	CSTCR6M00G53-R0				

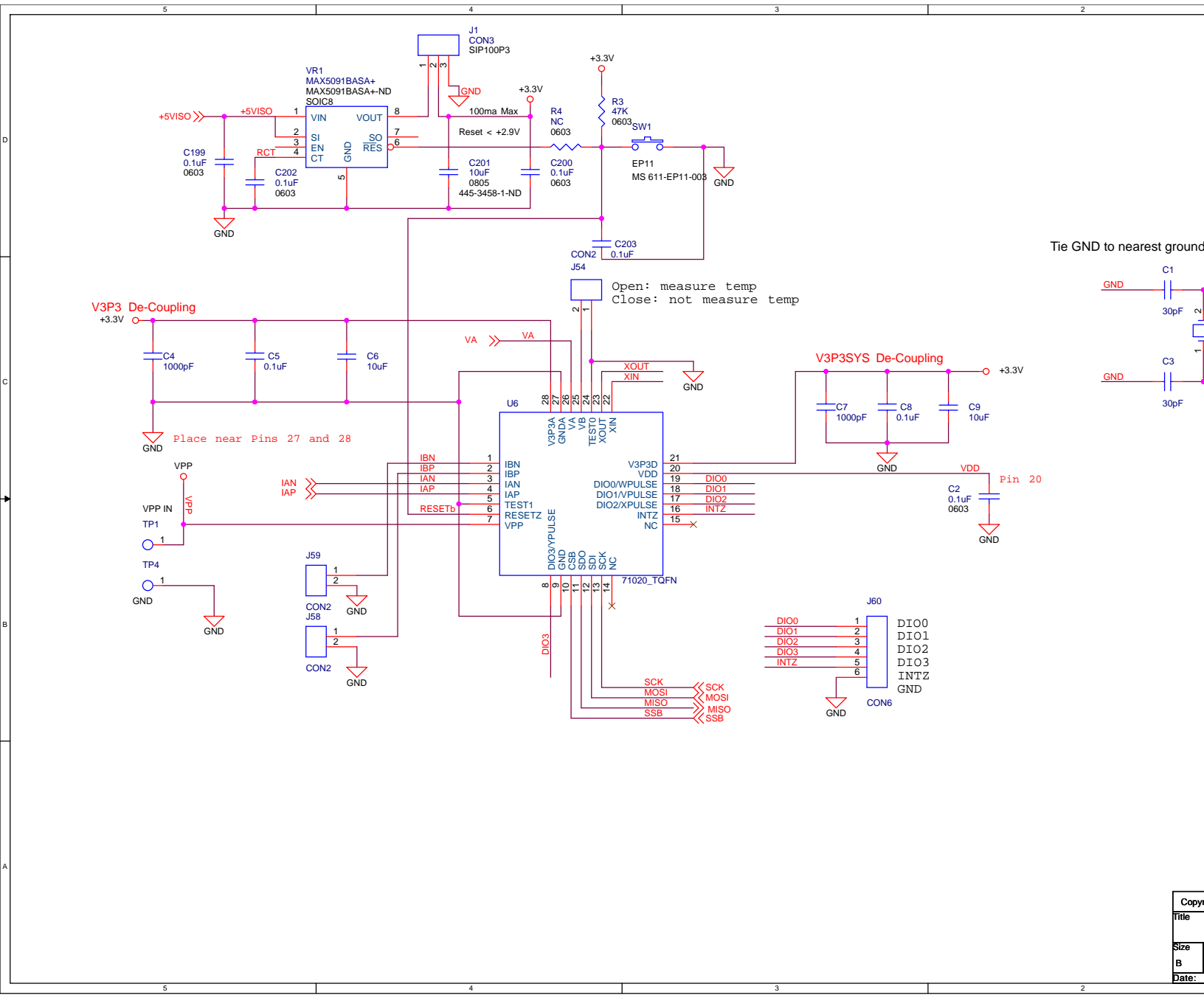

Copy  
Title  
Size  
B  
Date:

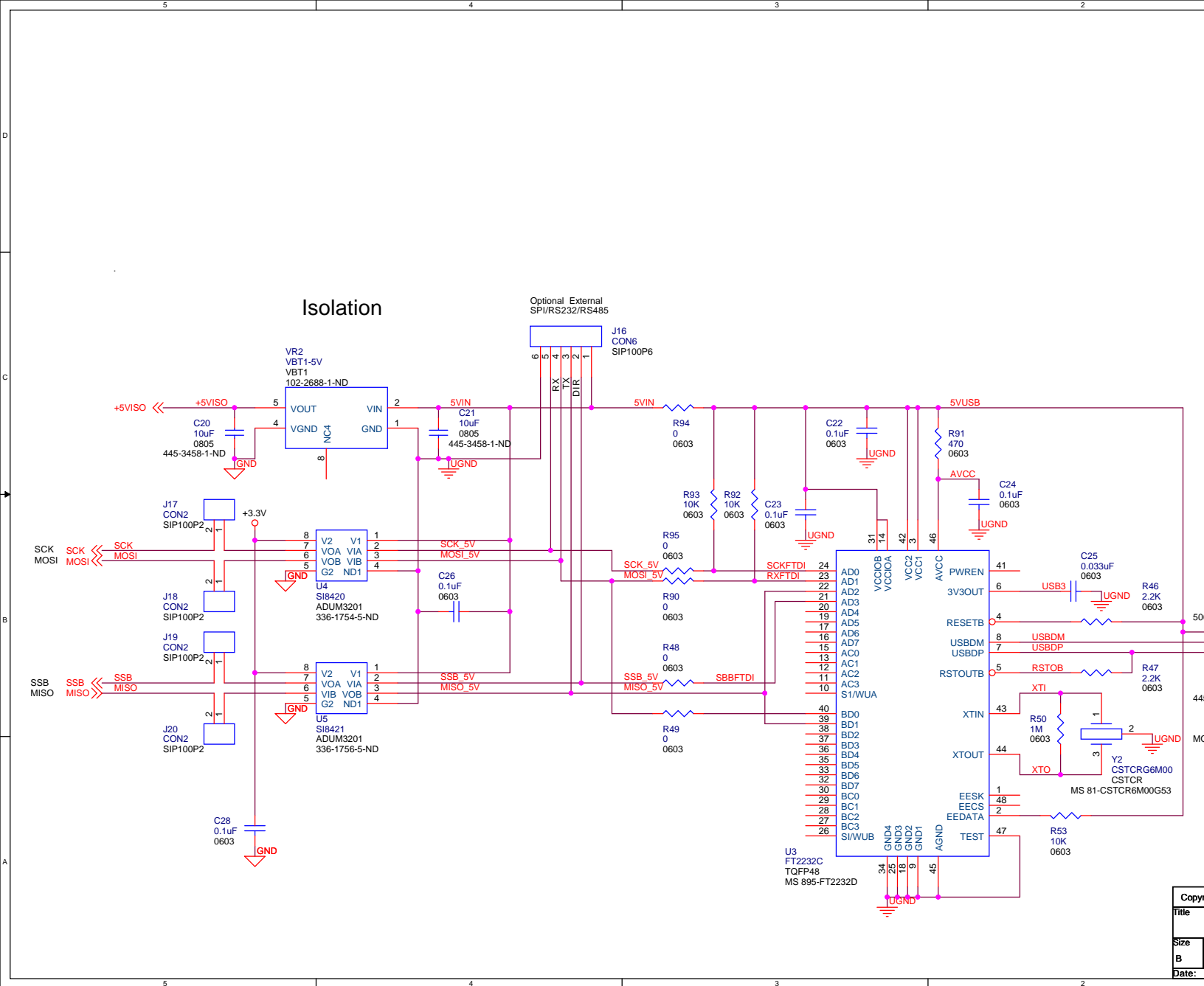

Copy  
Title  
Size  
B  
Date:



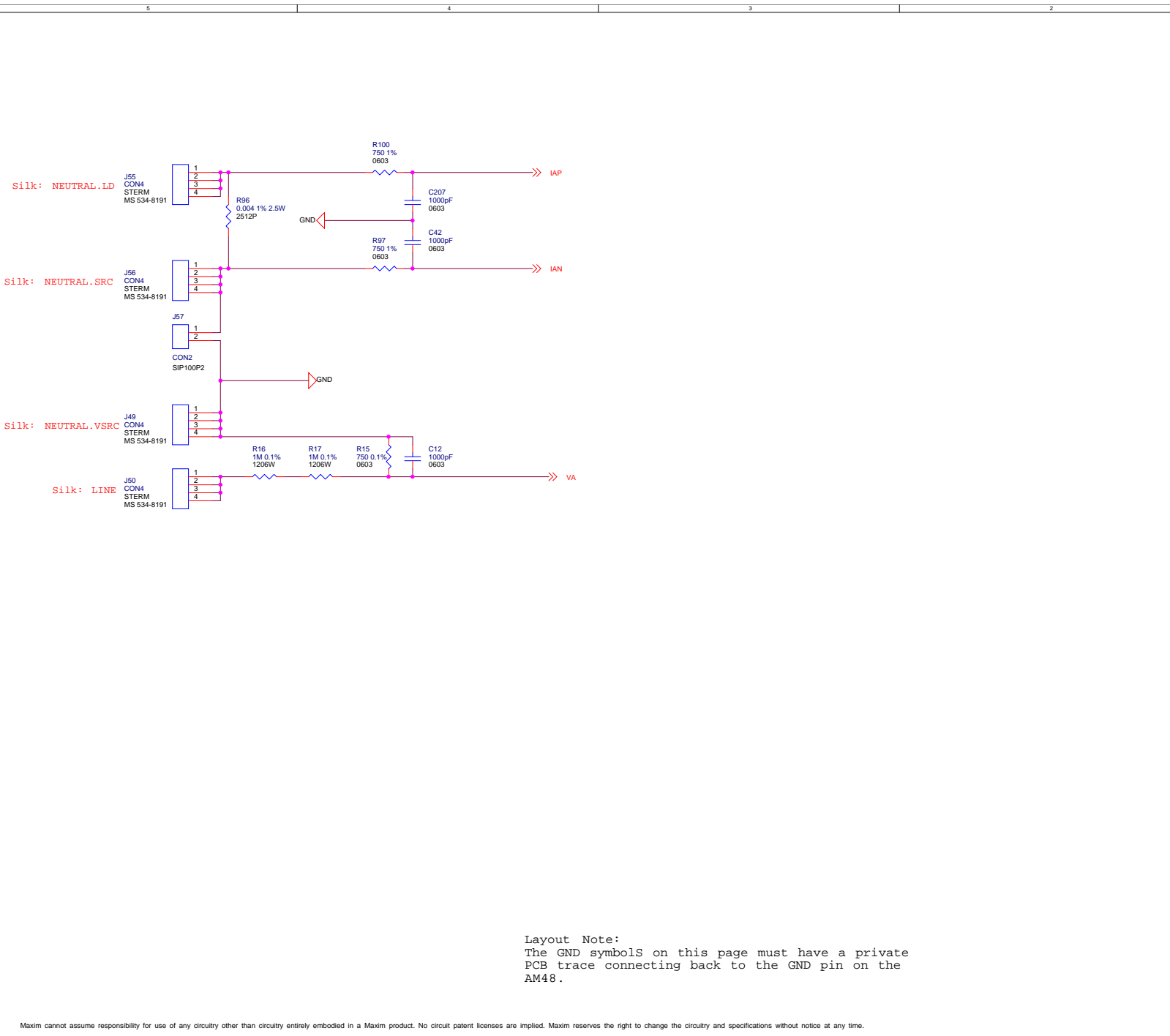

Layout Note:  
 The GND symbols on this page must have a private PCB trace connecting back to the GND pin on the AM48.

## X-ON Electronics

Largest Supplier of Electrical and Electronic Components

*Click to view similar products for [Power Management IC Development Tools](#) category:*

*Click to view products by [Maxim](#) manufacturer:*

Other Similar products are found below :

[EVB-EP5348UI](#) [MIC23451-AAAYFL EV](#) [MIC5281YMME EV](#) [124352-HMC860LP3E](#) [DA9063-EVAL](#) [ADP122-3.3-EVALZ](#) [ADP130-0.8-EVALZ](#) [ADP130-1.8-EVALZ](#) [ADP1740-1.5-EVALZ](#) [ADP1870-0.3-EVALZ](#) [ADP1874-0.3-EVALZ](#) [ADP199CB-EVALZ](#) [ADP2102-1.25-EVALZ](#) [ADP2102-1.875EVALZ](#) [ADP2102-1.8-EVALZ](#) [ADP2102-2-EVALZ](#) [ADP2102-3-EVALZ](#) [ADP2102-4-EVALZ](#) [AS3606-DB](#) [BQ25010EVM](#) [BQ3055EVM](#) [ISLUSBI2CKIT1Z](#) [LP38512TS-1.8EV](#) [EVAL-ADM1186-1MBZ](#) [EVAL-ADM1186-2MBZ](#) [ADP122UJZ-REDYKIT](#) [ADP166Z-REDYKIT](#) [ADP170-1.8-EVALZ](#) [ADP171-EVALZ](#) [ADP1853-EVALZ](#) [ADP1873-0.3-EVALZ](#) [ADP198CP-EVALZ](#) [ADP2102-1.0-EVALZ](#) [ADP2102-1-EVALZ](#) [ADP2107-1.8-EVALZ](#) [ADP5020CP-EVALZ](#) [CC-ACC-DBMX-51](#) [ATPL230A-EK](#) [MIC23250-S4YMT EV](#) [MIC26603YJL EV](#) [MIC33050-SYHL EV](#) [TPS60100EVM-131](#) [TPS65010EVM-230](#) [TPS71933-28EVM-213](#) [TPS72728YFFEVM-407](#) [TPS79318YEQEVM](#) [UCC28810EVM-002](#) [XILINXPWR-083](#) [LMR22007YMINI-EVM](#) [LP38501ATJ-EV](#)