

MAX77533 Evaluation Kit

Evaluates: MAX77533

General Description

The MAX77533 evaluation kit (EV kit) is a fully assembled and tested PCB that demonstrates the MAX77533 synchronous step-down (buck) converter. The EV kit is a step-down voltage regulator circuit using MAX77533 that is capable of 3V to 14V input, 1.5A continuous load, and output voltage adjustable between 0.8V and 5V (internal feedback options) or 1.55V and 99% of the input voltage (external feedback option).

The EV kit features a dual-range electronic load that allows easy evaluation of loading use cases for the buck converter circuit. Steady-state, transient, or random load profiles can be programmed.

A USB-to-I2C translator circuit allows a Windows®-based PC to run a graphical user interface (GUI) for easy control of the MAX77533 registers as well as the on-board electronic load.

Benefits and Features

- Proven PCB Reference Design and Layout
- Easy to Use
 - Simple Hardware Control: Jumpers and Test Points for EN, BIASEN, and POK
 - GUI Drives I2C Interface for Optional Software Control
 - Fully Assembled and Tested
- USB to I2C Converter Allows for Easy Communication
 - Windows-Based Software GUI Controls Registers
 - Level Translator (MAX3395) Allows for Adjusting I2C Bus Voltage from 1.8V to 3.3V
- On-Board Electronic Load Emulates System Loading
 - Steady-State, Transient, and Random Modes

Ordering Information appears at end of data sheet.



Figure 1. MAX77533 EV Kit Photo

Windows is a registered trademark and registered service mark of Microsoft Corporation.

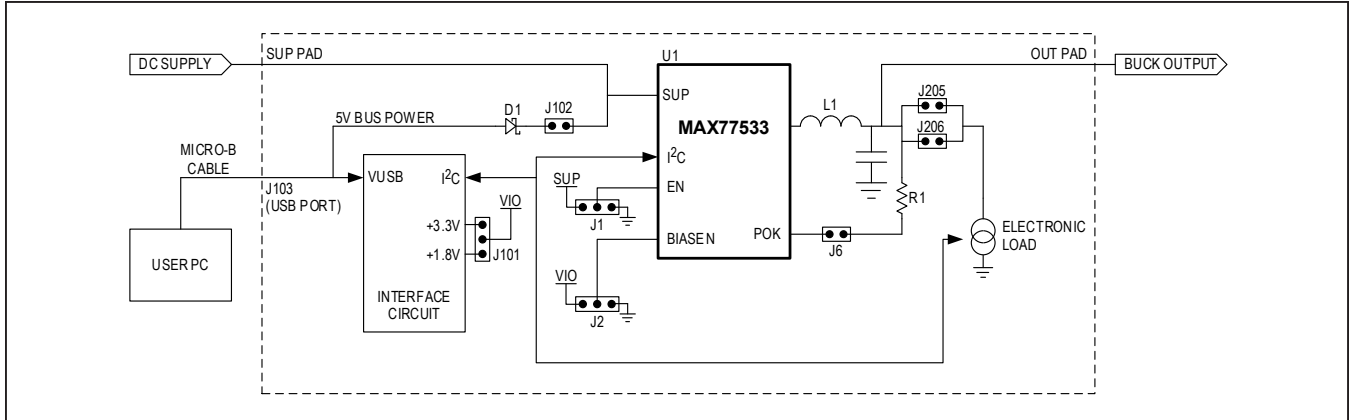

Figure 2. Simplified Block Diagram

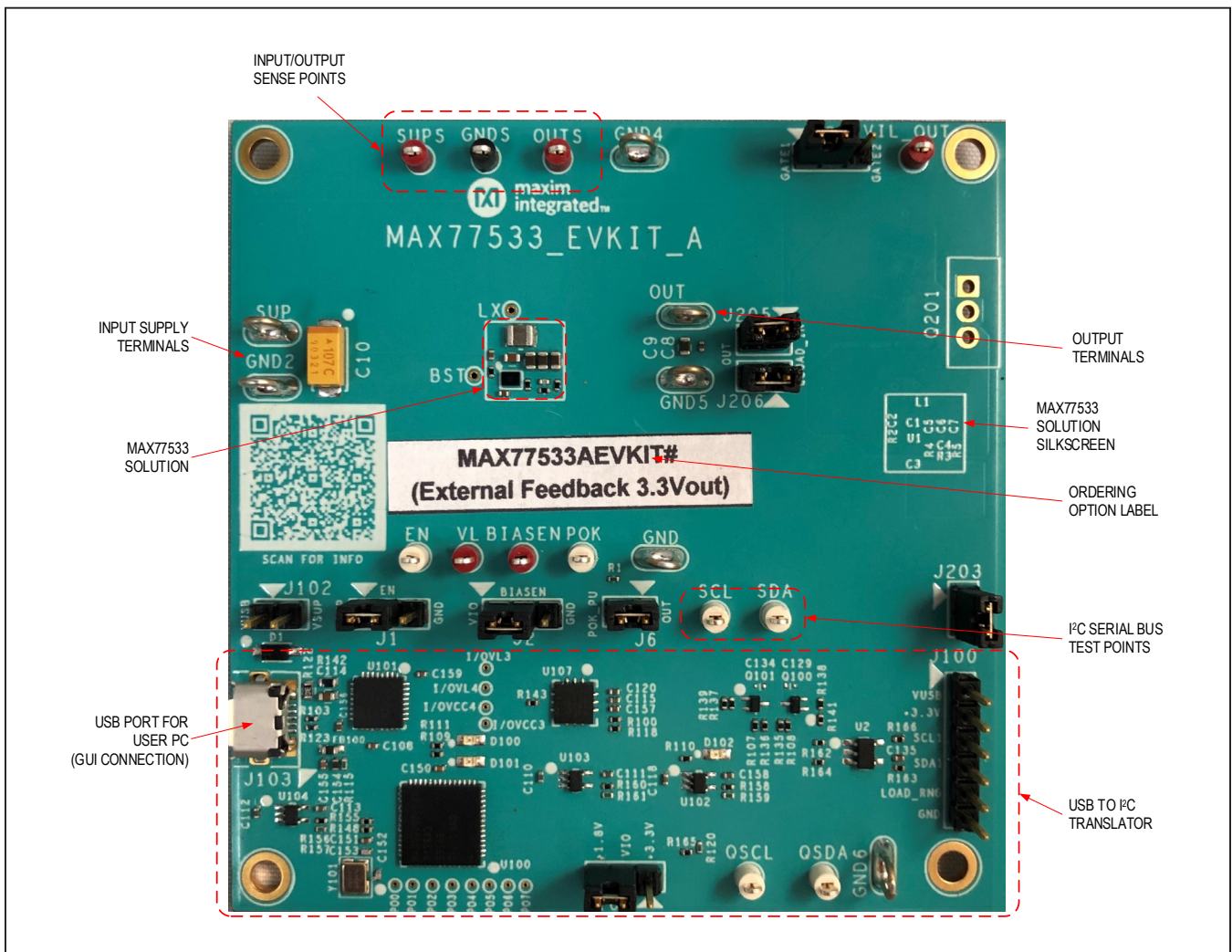

Figure 3. MAX77533 EV Kit Top View

EV Kit Default Configuration

- V_{IN} (SUP) = 3V to 14V
- V_{OUT} = 1.2V, 1.8V, or 3.3V depending on ordering option. Output is further adjustable:
 - 0.8V to 5V for internal feedback. See the [Setting the Output Voltage \(Internal Feedback Version\)](#) section.
 - 1.55V to 99% V_{SUP} for external feedback. See the [Setting the Output Voltage \(External Feedback Version\)](#) section.
- I_{OUT} = 1.5A maximum
- SKIP mode enabled (MODE = 0)
- 1ms soft-start time (t_{SS})
- 2A peak inductor current limit ($I_{LX-PEAK}$)
- Active discharge enabled (ADEN = 1, internal feedback versions only)
 - Active discharge function not available for external feedback version.

Quick-Start

Required Equipment

- MAX77533 EV kit
- Power supply with 15V and 2A capability
- Two digital voltmeters (DVM)
- Ammeter
- Windows-based PC
- Micro-USB cable
- GUI

Note: In the following sections, software-related items are identified by bolding. Text in **bold** refers to items directly from the EV kit software. Text in **bold and underlined** refers to items from the Windows operating system.

Procedure

- 1) Install EV kit shunts per [Table 1](#).
- 2) Connect a DVM to the SUPS and GNDS terminals to measure input voltage.

Table 1. Default Shunt Positions and Jumper Descriptions

REFERENCE DESIGNATOR	DEFAULT POSITION	FUNCTION
J1	1-2	1-2: Connects EN to VSUP 2-3: Connects EN to GND
J2	1-2	1-2: Connects BIASEN to VIO 2-3: Connects BIASEN to GND
J6	1-2	1-2: Connects POK to OUT through a 100k Ω resistor.
J100	N/A	J100 is an evaluation header. Do not connect shunts to J100.
J101	2-3	1-2: Sets the I ² C bus voltage to the 3.3V EV kit logic rail. 2-3: Sets the I ² C bus voltage to the 1.8V EV kit logic rail.
J102	Open	1-2: Connects VUSB to VSUP through Schottky diode, D1. Install this jumper to power the MAX77533 VSUP from VUSB. This jumper allows for communication with the MAX77533 through the on-board USB-to-I ² C translator without the need for an external power supply. Note: Remove this jumper any time an external power supply is applied as an input source.
J203	1-2	1-2: Connects the output of the MAX5805 DAC to drive the on board electronic load.
J204	1-2	1-2: Connects the U202 amplifier to the gate of the Q202 load MOSFET. 2-3: Connects the U202 amplifier to the gate of the Q201 depopulated TO-220 electronic load MOSFET.
J205 J206	1-2	1-2: Connects OUT to the onboard electronic load (each jumper supports up to 1A).

- 3) Connect a DVM to the OUTS and GNDS terminals to measure output voltage.
 - 4) Apply a power supply set to 0V (100mA current limit) through an ammeter (10mA range) across the SUP and GND2 terminals of the EV kit. Turn the supply on and increase the voltage to 12V.
 - 5) Confirm that the DVM connected to OUTS and GNDS reads the default output voltage of the EV kit. See [Table 2](#) for expected no-load output voltage at 12V supply.
- The next steps of the procedure use the software GUI and the MAX77533 I²C serial interface. If evaluation of the I²C bus is not required, then skip the following steps and connect SCL and SDA to GND using test leads. Unconnected (floating) SDA/SCL pins may chatter causing extra supply current draw.
- 6) Install GUI software. Visit the product webpage at www.maximintegrated.com/MAX77533evkit and navigate to *Design Resources* to download the latest version of the EV kit software. Save the EV kit software to a temporary folder and decompress the ZIP file. Run the .EXE file and follow the on-screen instructions to complete installation.
 - 7) Connect a Micro-B USB cable between the EV kit's J103 and your PC's USB port.
 - 8) Open the GUI and click the **Device** button in the menu bar. Click the **Connect** button in the **Device** button's drop-down list. Wait for the device to respond, and in the **Synchronize** window, press the **Read and Close** button.
 - 9) Increase the power supply's current limit from 100mA to 500mA or greater.
 - 10) Short out the series input ammeter or change its range from 10mA to 1A or greater.
 - 11) If the EV kit evaluates the internal feedback version of MAX77533, then drag the slider bar in **Config B** to change the output voltage and click **Write**. **Config B** is a *don't care* for the external feedback version of the MAX77533.
 - 12) Confirm with a DVM that the software instruction to change output voltage was successful.
- This concludes the Quick Start procedure. Users are now encouraged to explore the device and its register settings with the GUI. During general device evaluation, set the ammeter range to greater than or equal to 1A to minimize the impact of its series resistance.
- For more information on the GUI, see the [Software](#) section.

Table 2. EV Kit Measurements

EV KIT PART NUMBER	NO-LOAD SUPPLY CURRENT* AT 12V SUPPLY (µA)	OUTPUT VOLTAGE AT NO LOAD (SKIP MODE) (V)
MAX77533AEVKIT#	115	3.34
MAX77533B33EVKIT#	14	3.38
MAX77533B18EVKIT#	9	1.84
MAX77533B12EVKIT#	31	1.23

*Supply current measured value with jumper J101 (VIO select) installed and VUSB powered from J103 micro-B USB connector. The MAX77533 SDA/SCL pins must be pulled-up to a valid VIO supply or strapped to GND to achieve similar measurements. Unconnected (floating) SDA/SCL pins may chatter causing extra supply current draw.

Evaluating Different MAX77533 Versions

The EV kit is orderable with different versions of MAX77533 preinstalled (see [Table 3](#)). A label in the center of the PCB denotes the ordered part number and differentiates the EV kit options.

Any EV kit option can be reconfigured to evaluate any other version of the MAX77533.

- To evaluate the external feedback version, ensure that feedback resistors R3 and R4 are populated and adjusted according to the [Setting the Output Voltage \(External Feedback Version\)](#) section (MAX77533AEWC).
- To evaluate the internal feedback version, ensure that R3's value is 0Ω and R4 is open.

The values of R3 and R4 are initially set by Maxim per [Table 3](#).

Hardware

Electronic Load

To easily evaluate the MAX77533, the EV kit comes with an on-board, dual-range electronic load (10mA or 2.56A full-scale). See [Figure 4](#). Use 10mA range for

evaluation of small load currents to gain an understanding of MAX77533's SKIP mode and DCM performance. Use 2.56A range to evaluate the full load capability of MAX77533 (1.5A max) as well as the buck's response to overloads and soft-short circuits.

The electronic load is controllable with the GUI. The GUI controls an on-board DAC and op-amp configuration to set the load current. Parallel jumpers J205 and J206 connect the load to the output of the MAX77533. See the [Software](#) section for how to set the load current from the GUI.

To simulate load transient response, connect a signal generator to pin 2 of J204. Drive the MOSFET gate with an analog signal between 1V (off) and 3V (fully on) to apply transients to the output of the buck.

For manually measuring current, measure the voltage across the sense resistor using test point VIL_OUT. The value of the sense resistor changes depending on electronic load range.

- In 10mA range, the sense resistor is 49.9Ω.
- In 2.56A range, the sense resistor is 0.2Ω.

Use the GUI to set the range. See [Figure 10](#).

Table 3. EV Kit Component Default Values

EV KIT PART NUMBER	U1 IC	L1*	R3** (TOP FEEDBACK)	R4** (BOTTOM FEEDBACK)
MAX77533AEVKIT#	MAX77533AEWC+	4.7μH	10kΩ	3.24kΩ
MAX77533B33EVKIT#	MAX77533BEWC33+	4.7μH	0Ω	OPEN
MAX77533B18EVKIT#	MAX77533BEWC18+	2.2μH	0Ω	OPEN
MAX77533B12EVKIT#	MAX77533BEWC12+	2.2μH	0Ω	OPEN

*Default inductor case size is 2520 (metric).

**Default feedback resistor case size is 0402 (imperial).

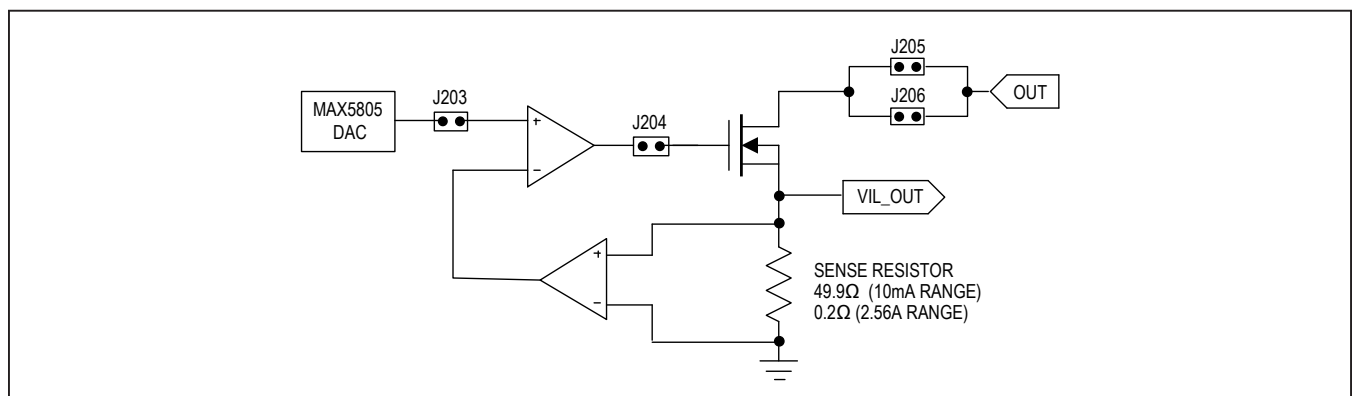

Figure 4. Electronic Load Block Diagram

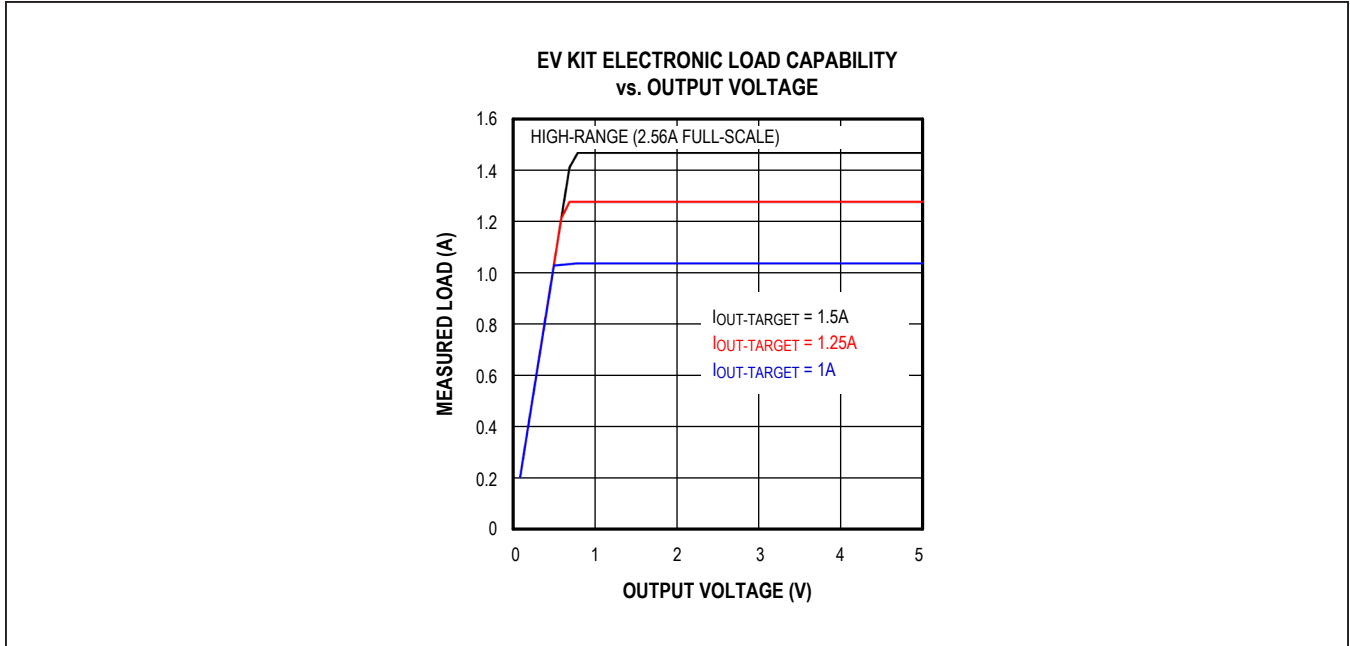

Figure 5. Electronic Load Capability vs. Voltage

Setting the Output Voltage (External Feedback Version)

The external feedback version of the device (MAX77533AEWC) uses resistors to set the output voltage between 1.55V and 99% of the input voltage. Use R3 and R4 to set the output voltage.

Choose R3 to be 10kΩ. Calculate the value of R4 for a desired output voltage with the following equation:

$$R4 = \frac{R3}{\left(\frac{V_{OUT}}{V_{FB}} - 1\right)}$$

where V_{FB} is 0.8V and V_{OUT} is the desired output voltage. Common values of R3 and R4 are listed in Table 4. For the internal feedback version of the MAX77533, use the software GUI to change the output voltage. See the [Setting the Output Voltage \(Internal Feedback Version\)](#) section for more information.

Table 4. Common Feedback Resistor Values

OUTPUT VOLTAGE TARGET (V)	R3 (kΩ)	R4 (kΩ)
1.55	10	10.7
1.85	10	7.68
2.05	10	6.34
2.5	10	4.75
3.0	10	3.65
3.3	10	3.24
3.5	10	2.94
5	10	1.91
5.6	10	1.65

Software

The graphical user interface (GUI) software allows for quick, easy, and thorough evaluation of the MAX77533. The GUI drives I²C-communication with the EV kit. Every control in the GUI (excluding the Load Control) corresponds directly to a register within the MAX77533. Refer to the *Register Map* section in the MAX77533 device data sheet for a complete description of the registers.

See [Figure 6](#) for a screenshot of the GUI upon first opening.

Installation

Visit the product webpage at www.maximintegrated.com/MAX77533evkit and navigate to Design Resources to download the latest version of the EV kit software. Save the EV kit software to a temporary folder and decompress the ZIP file. Run the .EXE file and follow the on-screen instructions to complete installation.

Windows Drivers

After connecting a Micro-USB cable between your PC and the EV kit for the first time, wait a few minutes for Windows to automatically install the necessary drivers.

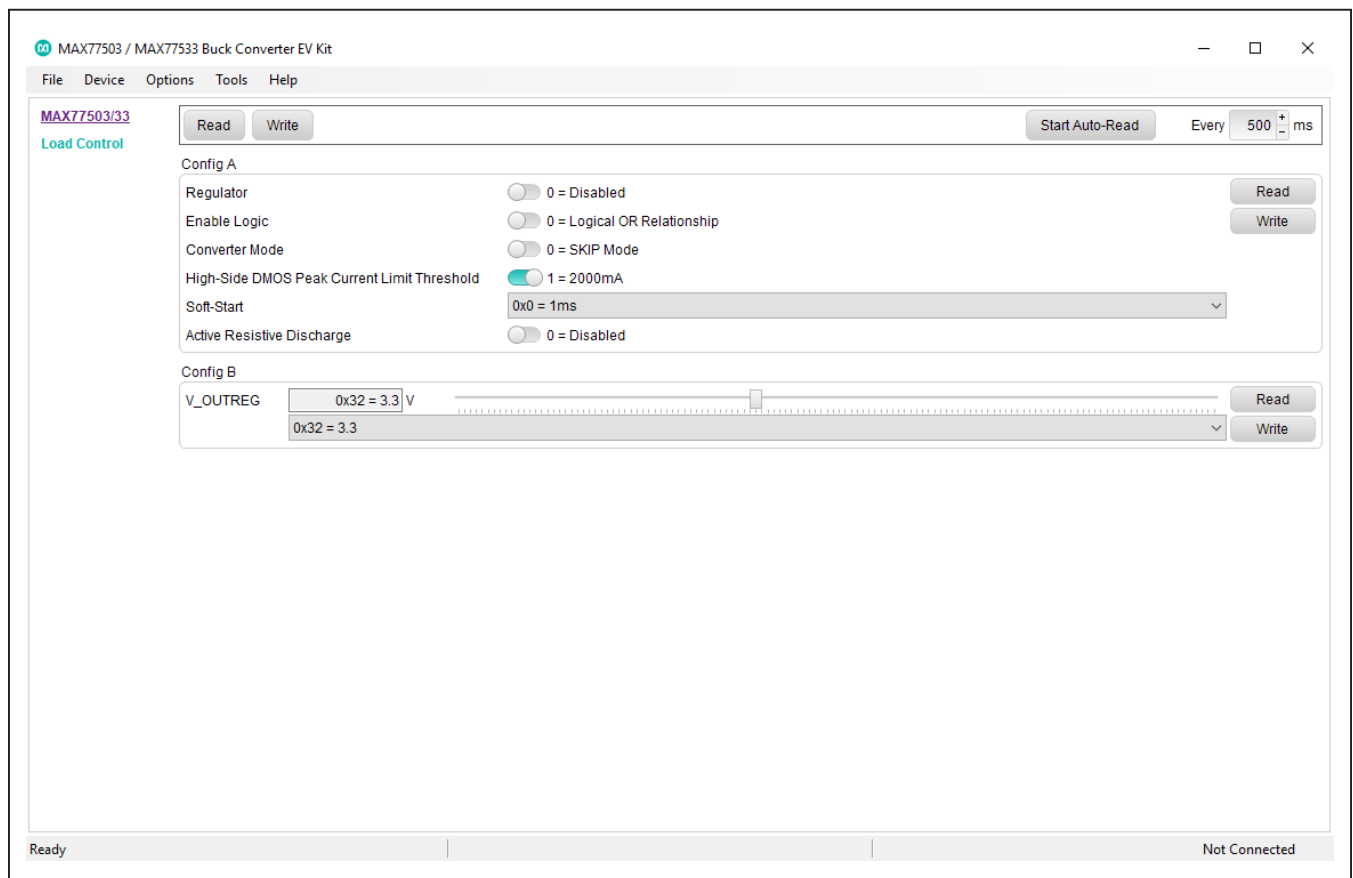

Figure 6. MAX77533 Evaluation Kit GUI Interface

Connecting the GUI

In the GUI, click **Device** in the upper left corner of the GUI window. Click the **Connect** option in the drop-down menu.

The **Synchronize** menu opens (Figure 7) once the MAX77533 responds (it must be powered and enabled through either EN or BIASEN to respond). Click **Read and Close**. The text at the bottom right of the GUI window changes from *Not Connected* to *Connected*.

The **Synchronize** menu shows the buck's I2C 8-bit device write address. The address shown changes depending on ordering option. See the [MAX77533 EV Kit Schematic](#) section of this document or the *MAX77533 device data sheet* for more information.

Configuring the Buck Converter

The MAX77533 features several different programmable options to customize the behavior of the regulator during startup, operation, and shutdown. Figure 8 shows the portion of the main GUI window that allows for configuration of the device.

Enabling and Disabling the Buck Converter

Turn on the device by clicking the toggle switch to the right of **Regulator** to change the value of the enable bit (EN_BIT). Alternatively, activate the regulator by bringing the EN pin logic-high by connecting the shunt on jumper J1 between terminals 1-2.

The default relationship between the GUI enable control (EN_BIT) and jumper J1's enable control (EN pin) is a logic OR. To change this relationship to a logical AND, click the toggle switch to the right of **Enable Logic** in the GUI.

Consult the *Buck Enable Control (EN)* section of the MAX77533 device data sheet for more information.

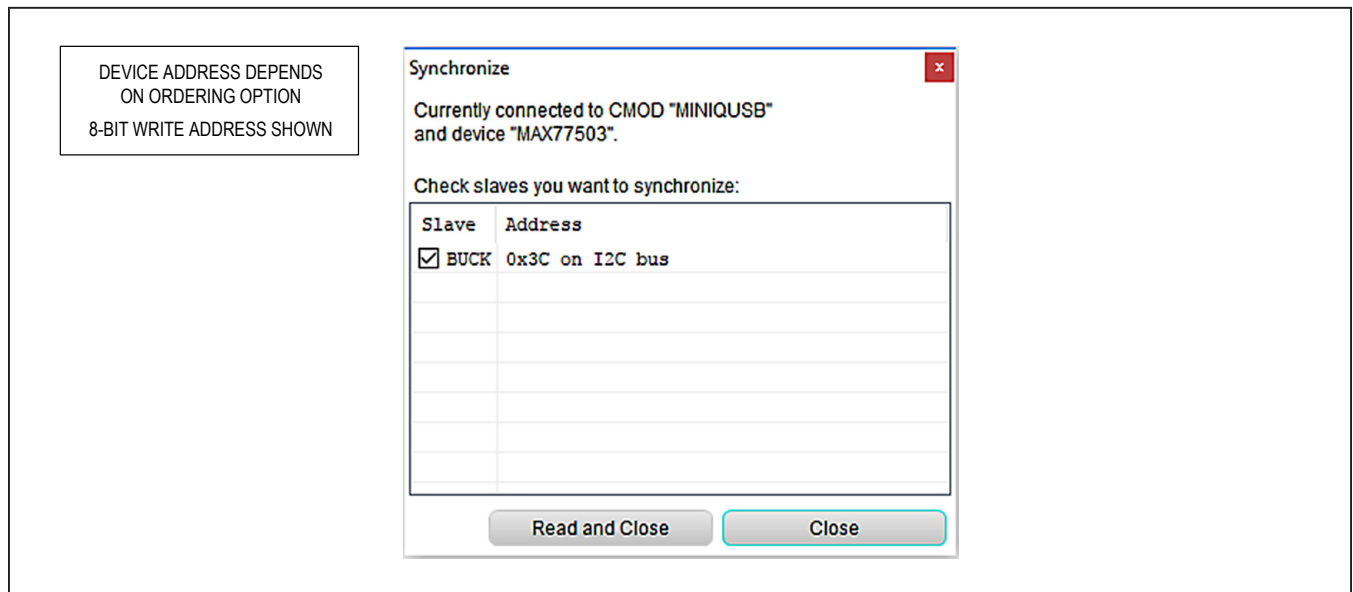

Figure 7. MAX77533 Evaluation Kit GUI Window after "Connecting"

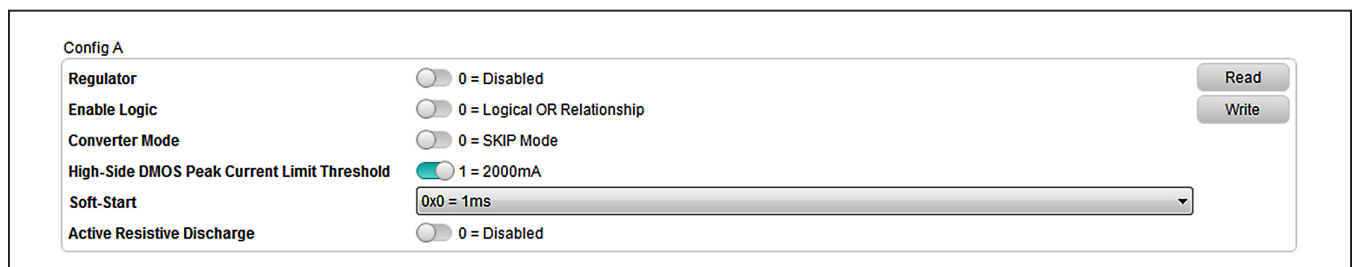

Figure 8. Config A Control Portion of Main GUI Window

Setting the Output Voltage (Internal Feedback Version)

The MAX77533 internal feedback version features a programmable output voltage from 0.8V to 5V in 50mV steps. External feedback resistors are not required.

When the EV kit is first powered on and connected to the GUI, the default output voltage appears in the **V_OUTREG** section of the GUI under **Config B** (Figure 9). Drag the slider or enter the desired output voltage and click **Write** to change the output voltage. Clicking **Read** returns the programmed output voltage to the GUI.

Avoid changing the output voltage target while the converter is both enabled and supplying load.

Config B is a *don't care* for the external feedback version of the MAX77533. See the [Setting the Output Voltage \(External Feedback Version\)](#) section for more information on how to set V_{OUT}.

Electronic Load Control Tab

The load control tab contains controls for setting load on the output. The GUI is capable of setting Steady State, Transient, and Random load currents. To set a load current, use the slider bar or text field to input a value (mA) and press the **Enable** button. Shuffle through the modes to exercise different load conditions.

Electronic load range is set with the toggle switch shown in Figure 10.

- 10mA range uses a 49.9Ω sense resistor (R249) for precise load control with 2.5μA of resolution.
- 2.56A range uses a 0.2Ω sense resistor (R245) for heavy loads with 0.625mA of resolution.

The offset and gain values are set by Maxim and do not need to be altered.

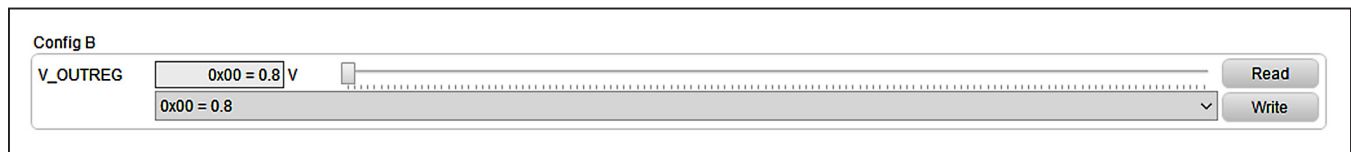

Figure 9. Config B Output Voltage Control Slider (MAX77533 Internal Feedback Version)

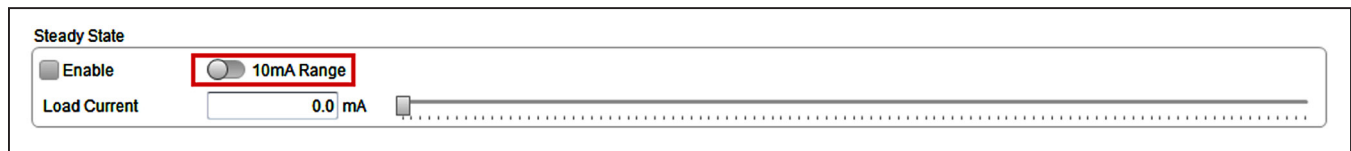

Figure 10. Electronic Load Range Control Switch

Ordering Information

PART NUMBER	U1 IC	VOLTAGE FEEDBACK	DEFAULT OUTPUT VOLTAGE
MAX77533AEVKIT#	MAX77533AEWC+	External	3.3V (set by R3 and R4)
MAX77533B33EVKIT#	MAX77533BEWC33+	Internal	3.3V
MAX77533B18EVKIT#*	MAX77533BEWC18+	Internal	1.8V
MAX77533B12EVKIT#*	MAX77533BEWC12+	Internal	1.2V

+Denotes a lead(Pb)-free/RoHS-compliant package.

*Future product—contact factory for availability.

EV kit differences detailed in [Table 3](#).

MAX77533 EV Kit Bill of Materials

REF_DES	QTY	MFG PART #	MANUFACTURER	VALUE	DESCRIPTION
U1	1	MAX77533 (see Table 3)	MAXIM	VARIABLE (see Table 3)	EVKIT PART-IC; MAX77533; 14V; 1.5A; HIGH-EFFICIENCY BUCK CONVERTER; PKG. DWG. NO.: 21-100250
L1	1	DFE252012F-xxxx	MURATA	4.7UH OR 2.2UH (see Table 3)	INDUCTOR; SMT (2520); METAL ALLOY CHIP; TOL = ±20%; >2A SAT
R2, R5	3	ANY	ANY	0	RESISTOR; 0402; 0Ω; 0%; JUMPER; 0.10W; THICK FILM; FORMFACTOR
R3	1	ANY	ANY	10K OR 0 (see Table 3)	RESISTOR, 0402, 1%, 100PPM, 0.0625W, THICK FILM; FORMFACTOR
R4	1	ANY	ANY	3.24K OR OPEN (see Table 3)	RESISTOR, 0402, 1%, 100PPM, 0.0625W, THICK FILM; FORMFACTOR
C1	1	ANY	ANY	4.7UF	CAPACITOR; SMT (0603); CERAMIC CHIP; 4.7UF; 25V; TOL = 10%; MODEL = ; TG = -55°C TO +85°C; TC = X5R ; FORMFACTOR
C2	1	ANY	ANY	0.22UF	CAPACITOR; SMT (0402); CERAMIC; 0.22UF; 16V; TOL = 10%; MODEL = GRM SERIES; TG = -55°C TO +125°C; TC = X7R; FORMFACTOR
C3	1	ANY	ANY	2.2UF	CAPACITOR; SMT (0402); CERAMIC; 2.2UF; 6.3V; TOL = [10%]; MODEL = C SERIES; TG = -55°C TO +85°C; TC = X5R
C4	1	C0402C569C5GAC	KEMET	100PF	CAPACITOR; SMT (0402); CERAMIC CHIP; 5.6PF; 50V; TOL = ±0.25PF; MODEL = ; TG = -55°C TO +125°C; TC = COG
C5-C7, C9	3	ANY	ANY	22UF	CAPACITOR; SMT (0603); CERAMIC CHIP; 22UF; 10V; TOL = 20%; MODEL = CL SERIES; TG = -55°C TO +85°C; TC = X5R; FORMFACTOR
C8	1	ANY	ANY	0.1UF	CAPACITOR; SMT; 0402; CERAMIC; 0.1uF; 10V; 10%; X5R; -55°C to + 125°C; 0 ±30PPM/°C; FORMFACTOR
Components below this line are outside of the immediate MAX77533 evaluation circuit and solution silkscreen.					
C10	1	TPSC107K016R0200	AVX	100UF	CAPACITOR; SMT (6032); TANTALUM CHIP; 100UF; 16V; TOL = 10%; MODEL = ; TG = -55°C TO +125°C
C108, C135, C150, C151, C155-C157, C159	8	ANY	ANY	0.1UF	CAPACITOR; SMT (0402); CERAMIC CHIP; 0.1UF; 50V; TOL = 10%; MODEL = CGA SERIES; TG = -55°C TO +125°C; TC = X7R; FORMFACTOR
C110-C113, C115, C118, C120, C158	8	ANY	ANY	1UF	CAPACITOR; SMT (0402); CERAMIC CHIP; 1UF; 6.3V; TOL = 10%; MODEL = ; TG = -55°C TO +85°C; TC = X5R;

MAX77533 EV Kit Bill of Materials (continued)

REF_DES	QTY	MFG PART #	MANUFACTURER	VALUE	DESCRIPTION
C114	1	ANY	ANY	0.47UF	CAPACITOR; SMT; 0603; CERAMIC; 0.47uF; 10V; 10%; X5R; -55°C to +125°C; ; FORMFACTOR
C152, C153	2	C0402C0G500-150JNP; GRM1555C1H150JA01	VENKEL LTD./ MURATA	15PF	CAPACITOR; SMT (0402); CERAMIC CHIP; 15PF; 50V; TOL = 5%; TG = -55°C TO +125°C; TC = C0G
C154	1	ANY	ANY	4.7UF	CAPACITOR; SMT (0402); CERAMIC CHIP; 4.7UF; 10V; TOL = 20%; MODEL = C SERIES; TG = -55°C TO +85°C; TC = X5R; FORMFACTOR
C211	1	ANY	ANY	1000PF	CAPACITOR; SMT (0402); CERAMIC CHIP; 1000PF; 50V; TOL = 10%; MODEL = C0G; TG = -55°C TO +125°C; TC = +; FORMFACTOR
C212, C221-C223	4	ANY	ANY	0.1UF	CAPACITOR; SMT (0402); CERAMIC CHIP; 0.1UF; 25V; TOL = 10%; MODEL = C SERIES; TG = -55°C TO +125°C; TC = X7R; FORMFACTOR
C213, C214	2	C0402C101K5GAC; C1005C0G1H101K050BA	KEMET/TKD	100PF	CAPACITOR; SMT; 0402; CERAMIC; 100pF; 50V; 10%; C0G; -55°C to +125°C; 0 ±30PPM/°C
C241	1	C1005X5R1C105K	TDK	1UF	CAPACITOR; SMT (0402); CERAMIC CHIP; 1UF; 16V; TOL = 10%; MODEL = C SERIES; TG = -55°C TO +85°C; TC = X5R
C250	1	C1005X5R1H472K050	TDK	4700PF	CAPACITOR; SMT (0402); CERAMIC CHIP; 4700PF; 50V; TOL = 10%; TG = -55°C TO +85°C; TC = X5R
D1	1	CMHSH5-4	CENTRAL SEMICONDUCTOR CORP.	CMHSH5-4	DIODE; SCH; SMT (SOD-123); PIV = 40V; IF = 0.5A; -65°C TO +125°C
D100, D101	2	LTST-C190YKT	LITE-ON ELECTRONICS; INC.	LTST-C190YKT	DIODE; LED; STANDARD; YELLOW; SMT (0603); PIV = 5.0V; IF = 0.02A; -55°C TO +85°C
D102	1	LTST-C190GKT	LITE-ON ELECTRONICS; INC.	LTST-C190GKT	DIODE; LED; WATER CLEAR GREEN; SMT (0603); VF = 2.1V; IF = 0.03A; -55°C TO +85°C
EN, POK, SCL, SDA, QSCL, QSDA	6	5002	KEYSTONE	N/A	TEST POINT; PIN DIA = 0.1IN; TOTAL LENGTH = 0.3IN; BOARD HOLE = 0.04IN; WHITE; PHOSPHOR BRONZE WIRE SILVER;
FB100	1	BLM18PG221SN1	MURATA	220	INDUCTOR; SMT (0603); FERRITE-BEAD; 220; TOL = ±25%; 1.4A; -55°C TO +125°C
GND, OUT, SUP, GND2, GND4- GND6	7	9020 BUSS	WEICO WIRE	MAXIMPAD	EVK KIT PARTS; MAXIM PAD; WIRE; NATURAL; SOLID; WEICO WIRE; SOFT DRAWN BUS TYPE-S; 20AWG
GND1, GND3, OUT1, SUP1	4	111-2223-001	EMERSON NETWORK POWER	111-2223-001	MACHINE SCREW; THUMBSCREW; BANANA; 1/4-32IN; 11/32IN; NICKEL PLATED BRASS

MAX77533 EV Kit Bill of Materials (continued)

REF_DES	QTY	MFG PART #	MANUFACTURER	VALUE	DESCRIPTION
GNDS	1	5001	KEYSTONE	N/A	TEST POINT; PIN DIA = 0.1IN; TOTAL LENGTH = 0.3IN; BOARD HOLE = 0.04IN; BLACK; PHOSPHOR BRONZE WIRE SILVER PLATE FINISH;
J1, J2, J101	3	TSW-103-07-T-S	SAMTEC	TSW-103-07-T-S	CONNECTOR; THROUGH HOLE; TSW SERIES; SINGLE ROW; STRAIGHT; 3PINS
J6, J203, J205, J206	4	TSW-102-07-T-S	SAMTEC	TSW-102-07-T-S	CONNECTOR; THROUGH HOLE; TSW SERIES; SINGLE ROW; STRAIGHT; 2PINS; -55°C TO +105°C
J100	1	PBC06SAAN	SULLINS ELECTRONICS CORP.	PBC06SAAN	CONNECTOR; MALE; THROUGH HOLE; BREAKAWAY; STRAIGHT; 6PINS; -65°C TO +125°C
J102	1	PBC02SAAN	SULLINS ELECTRONICS CORP.	PBC02SAAN	EVKIT PART-CONNECTOR; MALE; THROUGH HOLE; BREAKAWAY; STRAIGHT; 2PINS; -65°C TO +125°C;
J103	1	10103592-0001LF	FCI CONNECT	10103592-0001LF	CONNECTOR; FEMALE; SMT; MICRO USB B-TYPE REVERSE; RIGHT ANGLE; 5PINS
J204	1	PEC03SAAN	SULLINS ELECTRONICS CORP.	PEC03SAAN	EVKIT PART-CONNECTOR; MALE; THROUGH HOLE; BREAKAWAY; STRAIGHT; 3PINS; -65°C TO +125°C;
Q100, Q101	2	FDY300NZ	FAIRCHILD SEMICONDUCTOR	FDY300NZ	TRAN; SINGLE N-CHANNEL 2.5V SPECIFIED POWERTRENCH MOSFET; NCH; SC89; PD-(0.625W); I-(0.6A); V-(20V)
Q200	1	IRFHM8337TRPBF	INTERNATIONAL RECTIFIER	IRFHM8337TRPBF	TRAN; HEXFET POWER MOSFET; NCH; PQFN8; PD-(2.8W); I-(18A); V-(30V)
Q202	1	IRF3704ZSPBF	N/A	IRF3704ZSPBF	TRAN; HEXFET POWER MOSFET; NCH; D2PAK; PD-(57W); I-(67A); V-(20V)
VL, OUTS, SUPS, BIASEN, VIL_OUT	5	5000	KEYSTONE	N/A	TEST POINT; PIN DIA=0.1IN; TOTAL LENGTH = 0.3IN; BOARD HOLE = 0.04IN; RED; PHOSPHOR BRONZE WIRE SILVER PLATE FINISH;
R100, R118	2	ANY	ANY	4.7K	RESISTOR, 0402, 4.7KΩ, 1%, 100PPM, 0.0625W, THICK FILM; FORMFACTOR
R103, R123	2	ANY	ANY	22	RESISTOR, 0402, 22Ω, 1%, 100PPM, 0.0625W, THICK FILM; FORMFACTOR
R107, R108	2	ANY	ANY	2.2K	RESISTOR, 0402, 2.2KΩ, 1%, 100PPM, 0.0625W, THICK FILM; FORMFACTOR
R110	1	CRCW0402470RFK	VISHAY DALE	470	RESISTOR, 0402, 470Ω, 1%, 100PPM, 0.0625W, THICK FILM
R1, R120, R115, R157, R159, R161, R214, R283	8	ANY	ANY	100K	RESISTOR; 0402; 100K; 1%; 100PPM; 0.0625W; THICK FILM; FORMFACTOR

MAX77533 EV Kit Bill of Materials (continued)

REF_DES	QTY	MFG PART #	MANUFACTURER	VALUE	DESCRIPTION
R122	1	ANY	ANY	1M	RESISTOR; 0603; 1M; 1%; 100PPM; 0.10W; THICK FILM; FORMFACTOR
R135, R136, R139, R141, R143, R148, R155, R162-R166, R238, R305, R306	15	ANY	ANY	0	RESISTOR; 0402; 0Ω; 1%; 100PPM; 0.0625W; THICK FILM; FORMFACTOR
R137, R138	2	ANY	ANY	49.9	RESISTOR; 0402; 49.9Ω; 1%; 100PPM; 0.0625W; THICK FILM; FORMFACTOR
R142	1	ANY	ANY	0	RESISTOR; 0603; 0Ω; 0%; JUMPER; 0.10W; THICK FILM; FORMFACTOR
R156	1	CRCW0402105KFK	VISHAY DALE	105K	RESISTOR; 0402; 105KΩ; 1%; 100PPM; 0.063W ; THICK FILM
R158	1	CRCW0402169KFK	VISHAY DALE	169K	RESISTOR; 0402; 169KΩ; 1%; 100PPM; 0.063W; THICK FILM
R160	1	CRCW04024752FK; 9C04021A4752FLHF3; CRCW040247K5FK	VISHAY DALE	47.5K	RESISTOR; 0402; 47.5K; 1%; 100PPM; 0.0625W; THICK FILM
R109, R111, R235	3	CRCW0402100RFK; 9C04021A1000FL; RC0402FR-07100RL	VISHAYDALE; PANASONIC; YAGEOPHYCOMP	100	RESISTOR; 0402; 100Ω; 1%; 100PPM; 0.063W; THICKFILM
R236	1	CRCW0402680RFK; RC0402FR-07680RL	VISHAY DALE/ YAGEO PHICOMP	680	RESISTOR, 0402, 680Ω, 1%, 100PPM, 0.0625W, THICK FILM
R237	1	CRCW040220K0FK	VISHAY DALE	20K	RESISTOR; 0402; 20KΩ; 1%; 100PPM; 0.063W; THICK FILM
R239, R240	2	CRCW04024K02FK; ERJ-2RKF4021X	VISHAY DALE/ PANASONIC	4.02K	RESISTOR; 0402; 4.02K; 1%; 100PPM; 0.0625W; THICK FILM
R242, R243	2	ANY	ANY	1K	RESISTOR; 0402; 1K; 1%; 100PPM; 0.0625W; THICK FILM; FORMFACTOR
R244, R246, R251	3	CRCW04021M00FK	VISHAY DALE	1M	RESISTOR; 0402; 1M; 1%; 100PPM; 0.0625W; THICK FILM
R245	1	WSL2512R2000F	VISHAY DALE	0.2	RESISTOR; 2512; 0.2Ω; 1%; 75PPM; 1.0W; THICK FILM
R249	1	CRCW080549R9FK; ERJ-6ENF49R9	VISHAY DALE; PANASONIC	49.9	RESISTOR; 0805; 49.9Ω; 1%; 100PPM; 0.125W; THICK FILM
R252	1	CRCW040210K0FK; RC0402FR-0710K	VISHAY DALE; YAGEO PHICOMP	10K	RESISTOR; 0402; 10K; 1%; 100PPM; 0.0625W; THICK FILM
R297	1	ERJ-2RKF4703X	PANASONIC	470K	RESISTOR, 0402, 470KΩ, 1%, 100PPM, 0.0625W, THICK FILM

MAX77533 EV Kit Bill of Materials (continued)

REF_DES	QTY	MFG PART #	MANUFACTURER	VALUE	DESCRIPTION
R298	1	CRCW0402649KFK	VISHAY DALE	649K	RESISTOR; 0402; 649KΩ; 1%; 100PPM; 0.063W; THICK FILM
U2	1	24AA02T-I/OT	MICROCHIP	24AA02T-I/OT	IC; EPROM; 2K I2C SERIAL EEPROM; SOT23-5
U100	1	MAXQ2000-RBX+	MAXIM	MAXQ2000-RBX+	IC; CTRL; LOW-POWER LCD MICROCONTROLLER; TQFN56-EP 8X8
U101	1	FT232RQ	FUTURE TECHNOLOGY DEVICES INTL LTD.	FT232RQ	IC; INFC; UART INTERFACE IC USB TO SERIAL; QFN32-EP 5X5
U102-U104	3	MAX8512EXK	MAXIM	MAX8512EXK	IC, VREG, Ultra-Low-Noise, High PSRR, Adjustable Vout, SC70-5
U107	1	MAX3395EETC	MAXIM	MAX3395EETC	IC; TRANS; 15KV ESD-PROTECTED HIGH-DRIVE CURRENT QUAD-LEVEL TRANSLATOR WITH SPEED-UP CIRCUITRY; TQFN12 4X4
U202	1	MAX44251AUA+	MAXIM	MAX44251AUA+	IC; OPAMP; ULTRA-PRECISION; LOW-NOISE OP AMP; UMAX8
U205	1	MAX5805AAUB+	MAXIM	MAX5805AAUB+	IC; DAC; ULTRA-SMALL, SINGLE-CHANNEL, 12-BIT BUFFERED OUTPUT DAC WITH INTERNAL REFERENCE AND I2C INTERFACE; UMAX10
Y101	1	CX3225SB16000 D0FLJZZ	KYOCERA-KINSEKI	16MHZ	CRYSTAL; SMT (3225) 3.2X2.5; 8PF; 16MHZ; ±10PPM; ±15PPM
PCB	1	MAX77533 SOLDERDOWN	MAXIM	PCB	PCB:MAX77533SOLDERDOWN
Q201	0	PSMN022-30PL	NXP	PSMN022-30PL	TRAN; N-CHANNEL 30V 22MOHM LOGIC LEVEL MOSFET; NCH; TO-220AB; PD-(41W); I-(30A); V-(30V)
C11, C129, C134	0	N/A	N/A	OPEN	CAPACITOR; SMT (0402); OPEN; FORMFACTOR

MAX77533 EV Kit Schematic

Part Number	Configuration	7-bit	8-bit Write	8-bit Read
MAX77533AEWC+	External Feedback version (default U1 installed on MAX77533AEVKIT#)	0x1E 0b001 1110	0X3C 0b0011 1100	0x3D 0b0011 1101
MAX77533BEWC33+	Internal Feedback version (default U1 installed on MAX77533B33EVKIT#)	0x1E 0b001 1110	0X3C 0b0011 1100	0x3D 0b0011 1101
MAX77533BEWC18+	Internal Feedback version (default U1 installed on MAX77533B18EVKIT#)	0x24 0b010 0100	0X48 0b0100 1000	0x49 0b0100 1001
MAX77533BEWC12+	Internal Feedback version (default U1 installed on MAX77533B12EVKIT#)	0x37 0b011 0111	0x6E 0b0110 1110	0x6F 0b0110 1111
MAX5805 (DAC)	ADDR=GND	0x18 0b001 1000	0x30 0b0011 0000 0x32 *** 0b0011 0010	0x31 0b0011 0001
24AA02 (EEPROM)	N/A	0x50 to 0x57 0b1010xxx	0b1010xxx0	0b1010xxx1

*** MAX5805 also responds to an I2C Broadcast Address 0b0011 0010 (8-bit)

MAX77533 EV Kit Schematic (continued)

EV KIT PART NUMBER	U1 IC	L1	R3 TOP FEEDBACK	R4 BOTTOM FEEDBACK
MAX77533AEVKIT#	MAX77533AEWC+	4.7µH	10K	3.24K
MAX77533BEVKIT#	MAX77533BEWC33+	4.7µH	0	OPEN
MAX77533B1BEVKIT#	MAX77533BEWC18+	2.2µH	0	OPEN
MAX77533B12BEVKIT#	MAX77533BEWC12+	2.2µH	0	OPEN

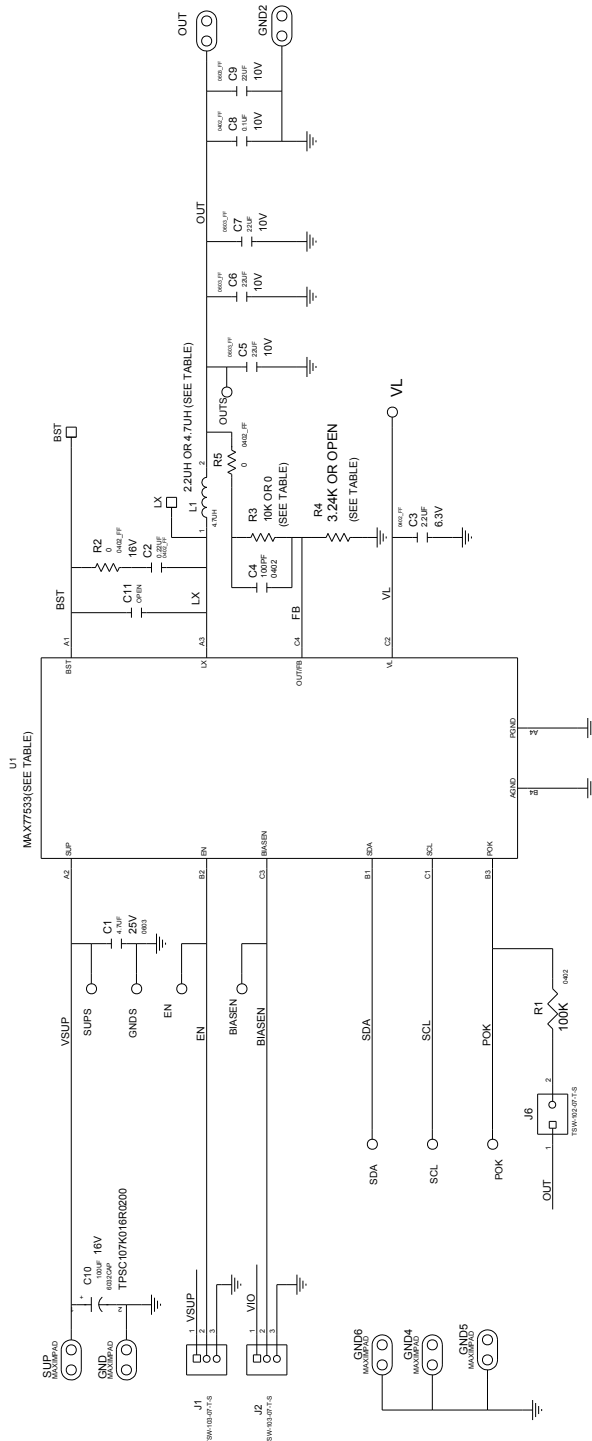

MAX77533 EV Kit Schematic (continued)

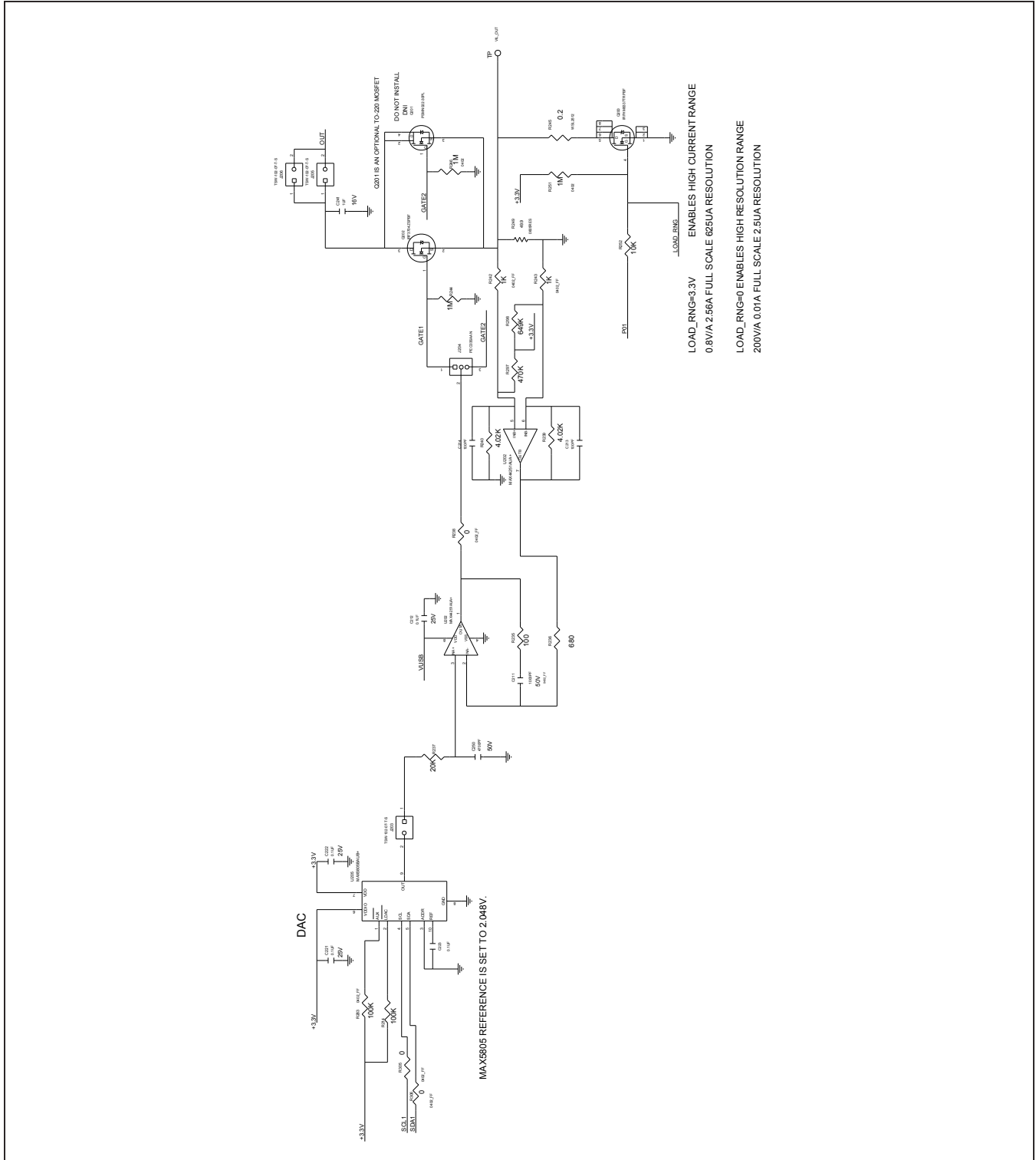

MAX77533 EV Kit PCB Layouts

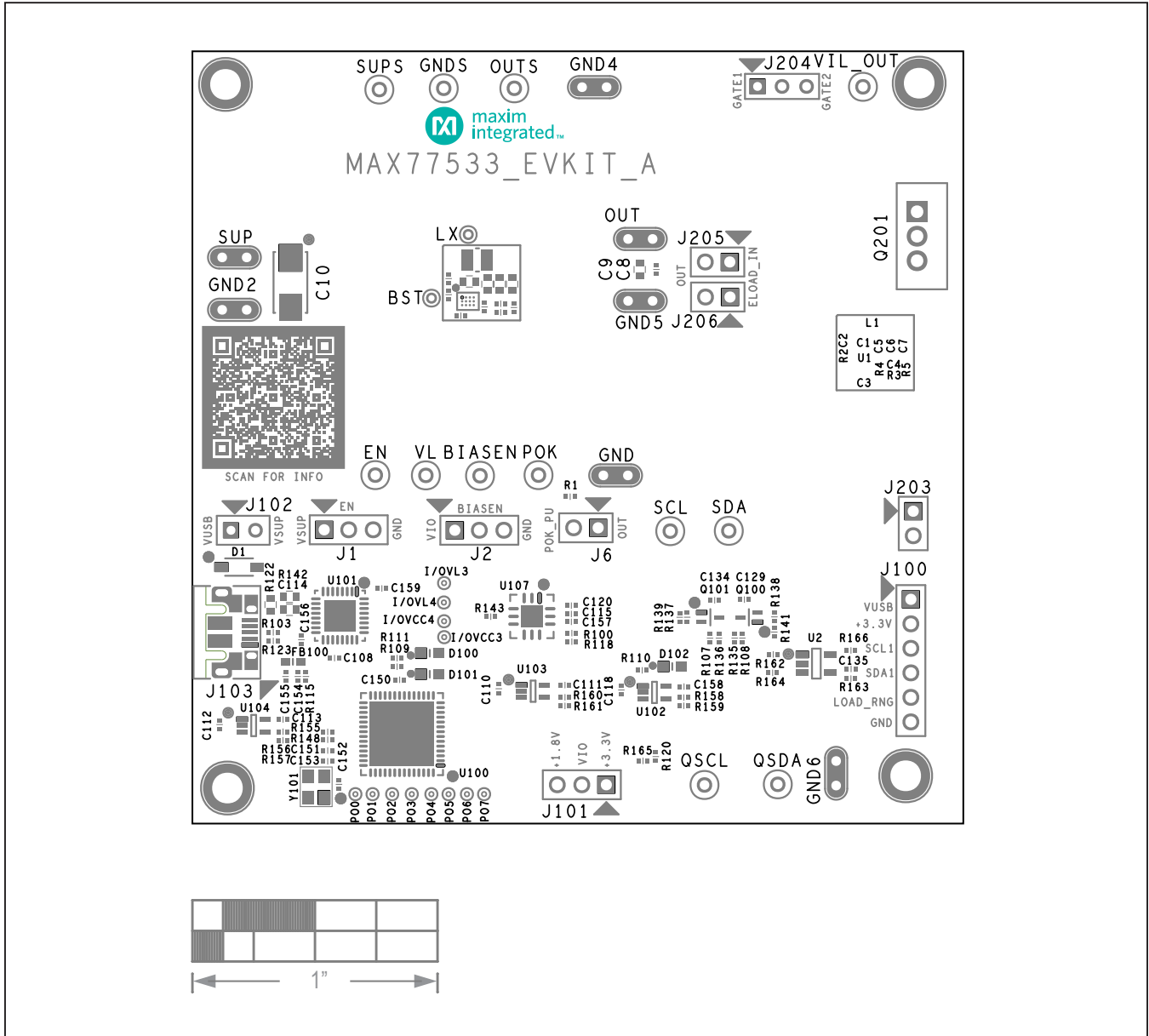

MAX77533 EV Kit Component Placement Guide—Top Silkscreen

MAX77533 EV Kit PCB Layouts (continued)

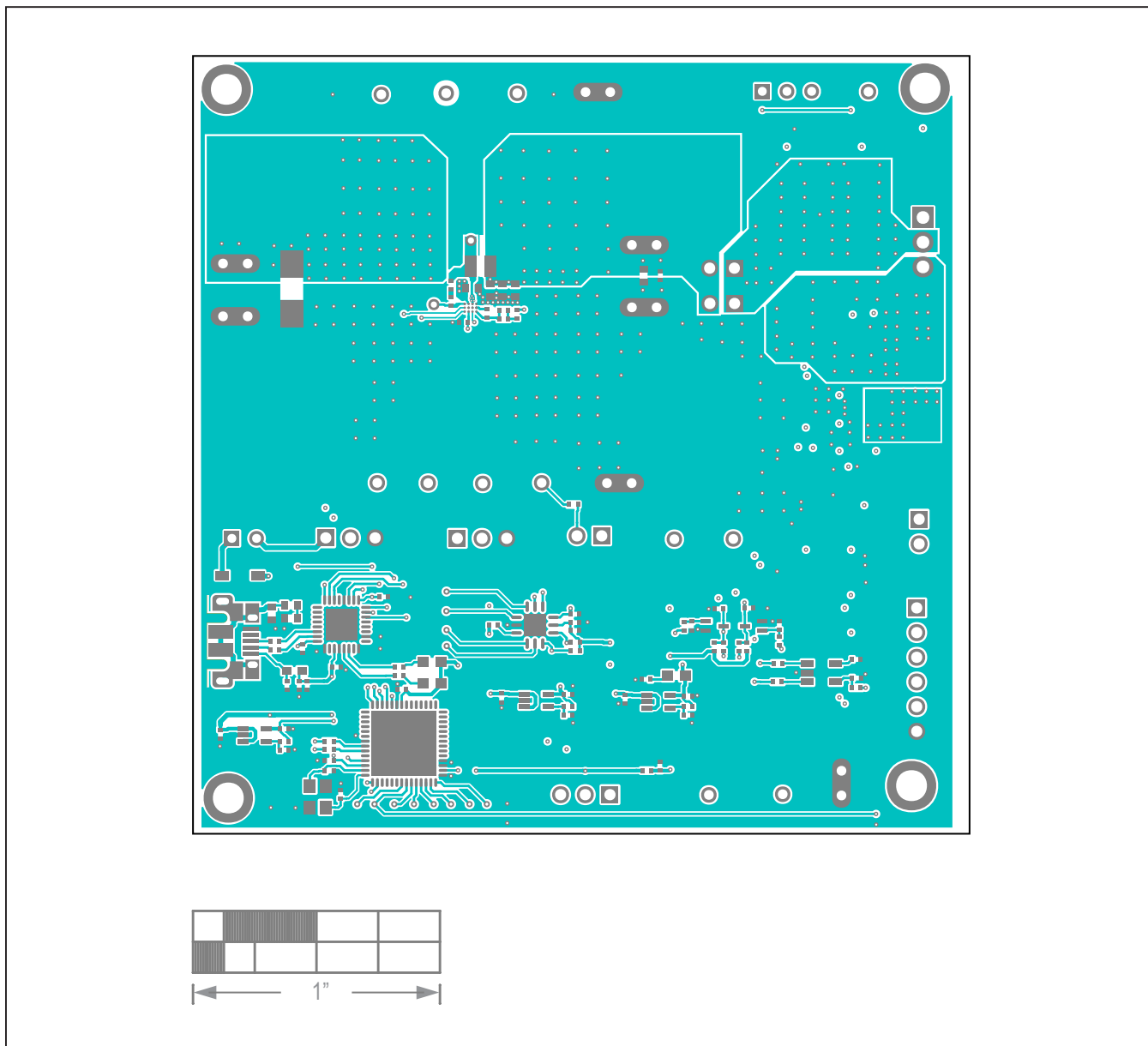

MAX77533 EV Kit PCB Layout—Top Layer

MAX77533 EV Kit PCB Layouts (continued)

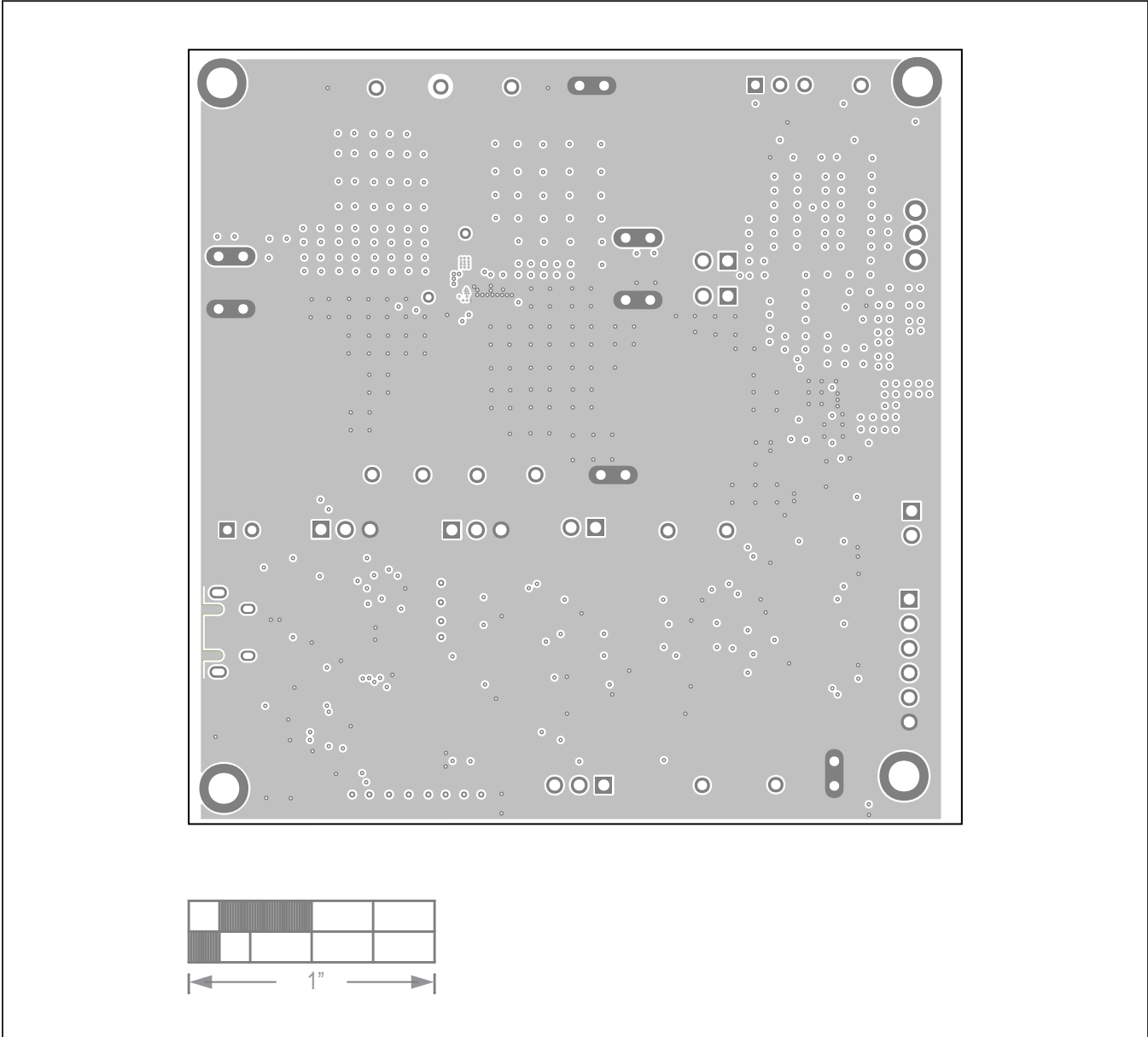

MAX77533 EV Kit PCB Layout—Internal Layer 2

MAX77533 EV Kit PCB Layouts (continued)

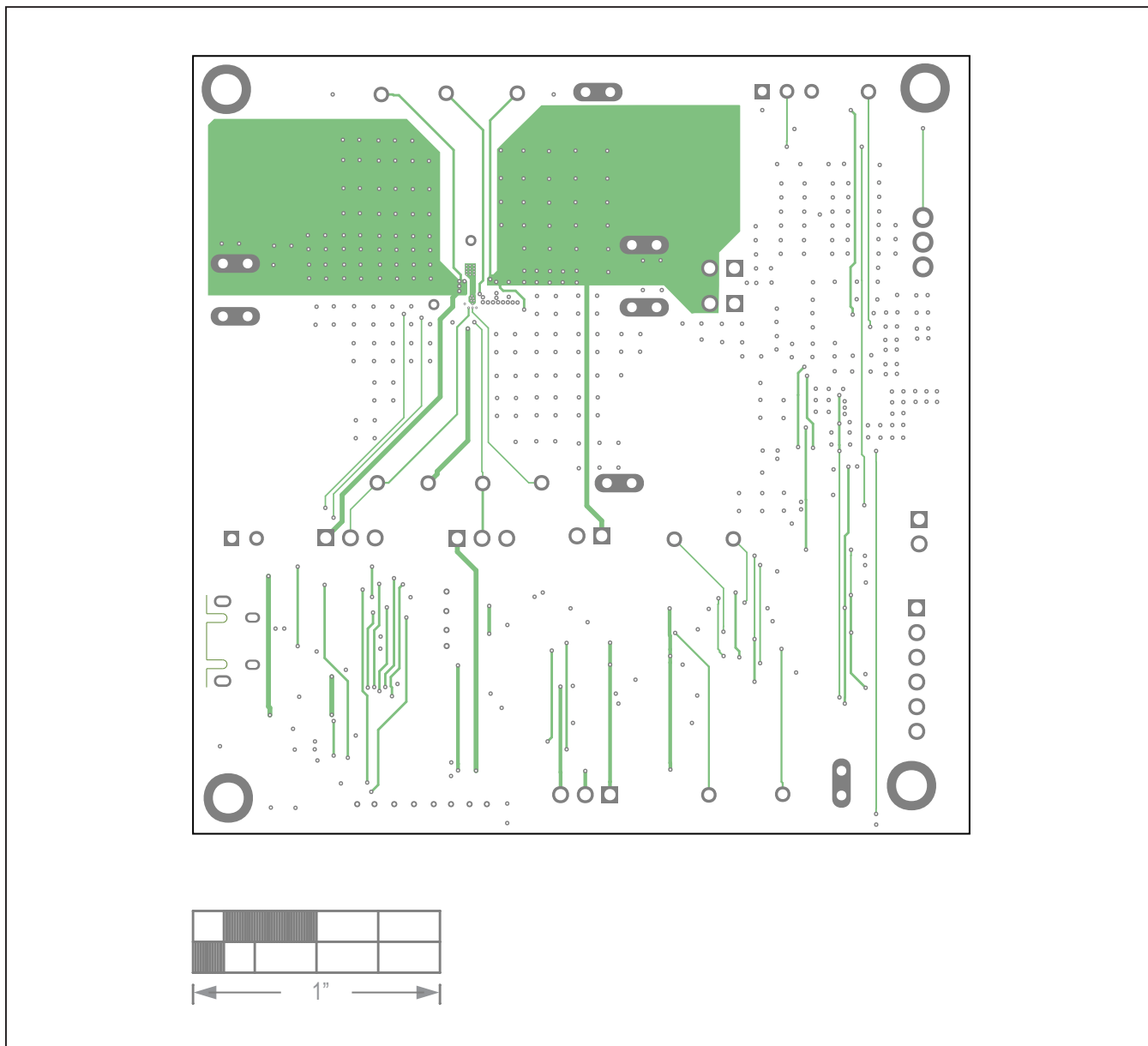

MAX77533 EV Kit PCB Layout—Internal Layer 3

MAX77533 EV Kit PCB Layouts (continued)

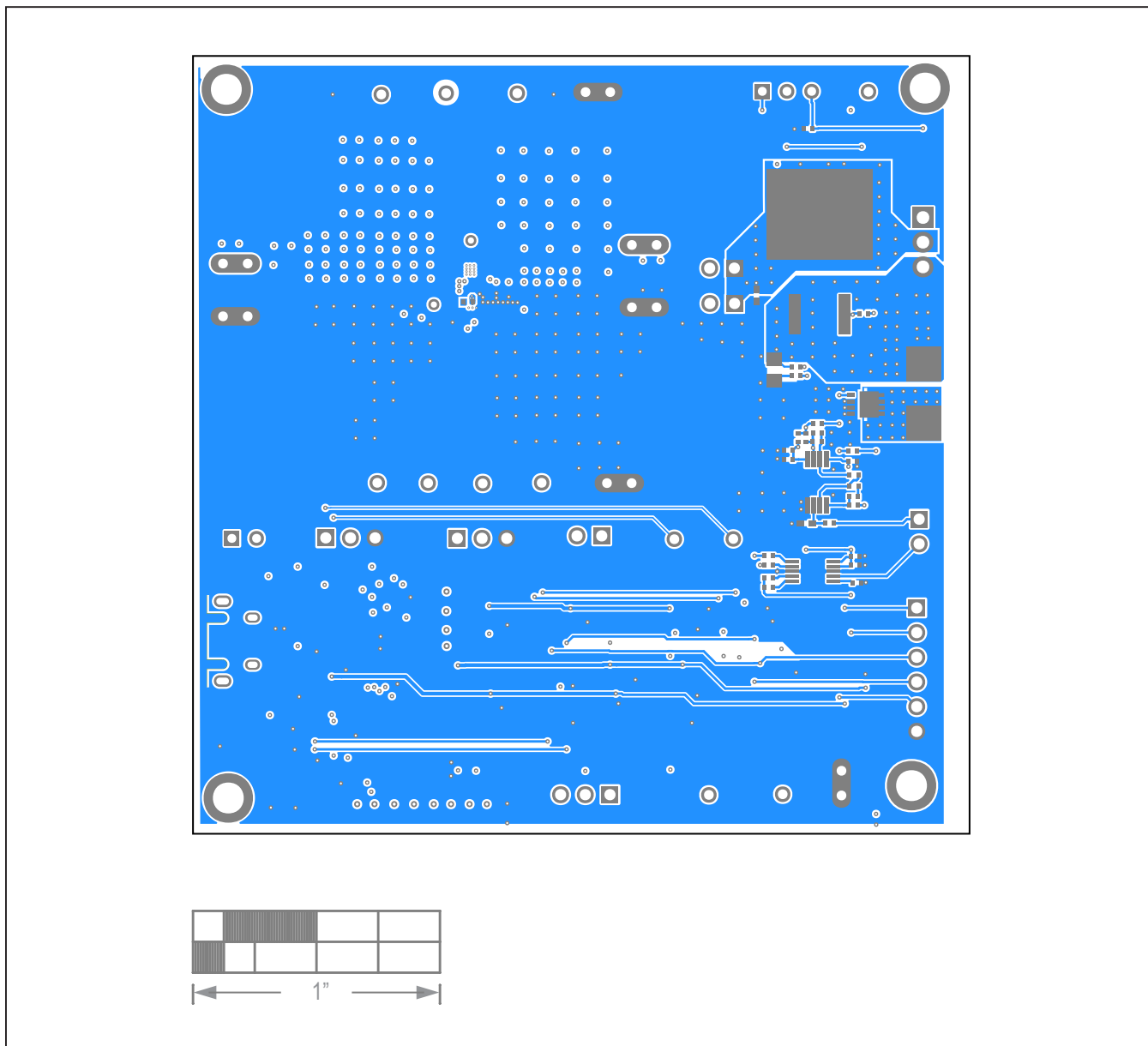

MAX77533 EV Kit PCB Layout—Bottom Layer

MAX77533 EV Kit PCB Layouts (continued)

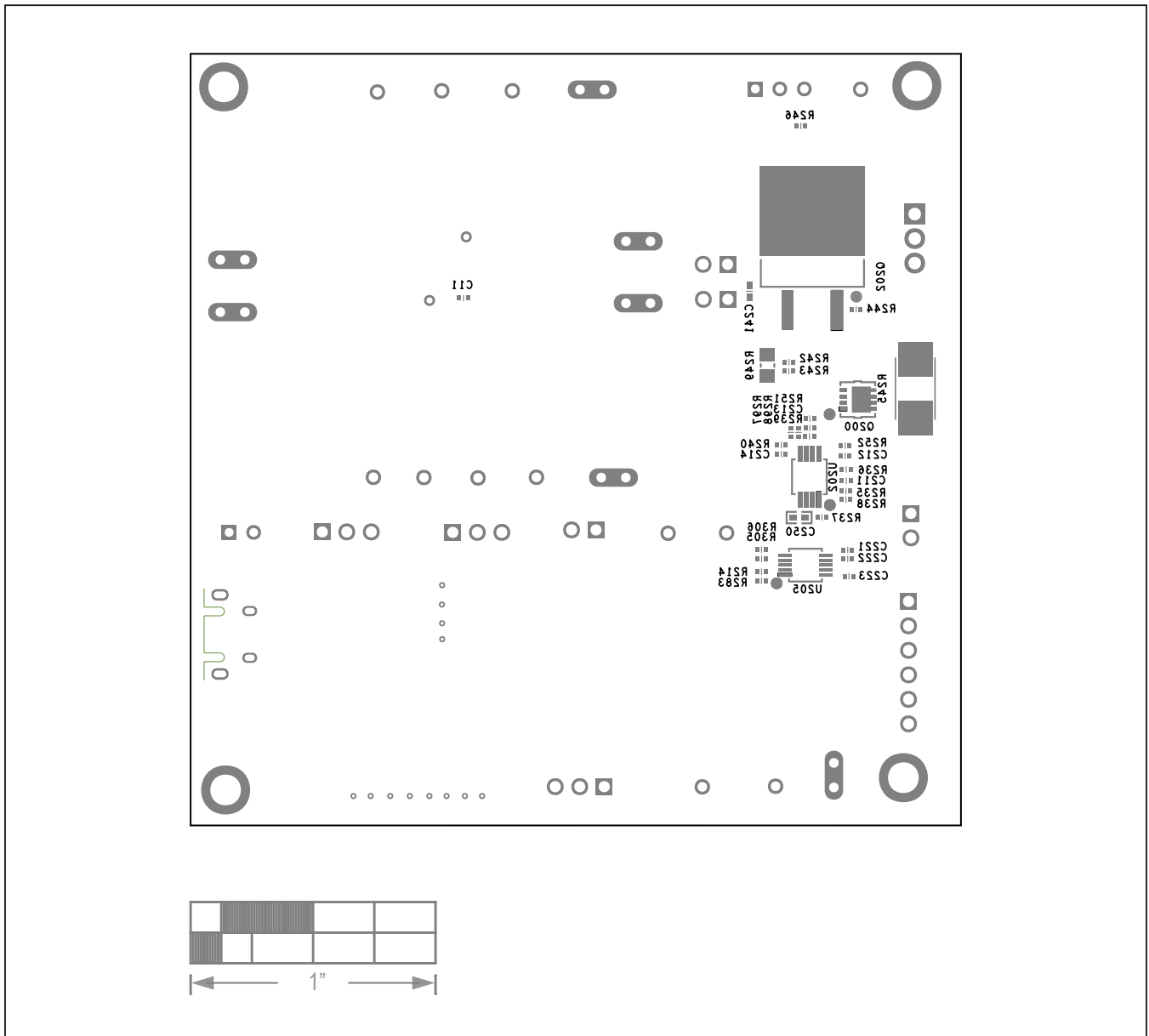

MAX77533 EV Kit Component Placement Guide—Bottom Silkscreen

Revision History

REVISION NUMBER	REVISION DATE	DESCRIPTION	PAGES CHANGED
0	8/20	Initial release	—

For pricing, delivery, and ordering information, please visit Maxim Integrated's online storefront at <https://www.maximintegrated.com/en/storefront/storefront.html>.

Maxim Integrated cannot assume responsibility for use of any circuitry other than circuitry entirely embodied in a Maxim Integrated product. No circuit patent licenses are implied. Maxim Integrated reserves the right to change the circuitry and specifications without notice at any time.

X-ON Electronics

Largest Supplier of Electrical and Electronic Components

Click to view similar products for [Power Management IC Development Tools](#) category:

Click to view products by [Maxim](#) manufacturer:

Other Similar products are found below :

[EVB-EP5348UI](#) [MIC23451-AAAYFL EV](#) [MIC5281YMME EV](#) [124352-HMC860LP3E](#) [DA9063-EVAL](#) [ADP122-3.3-EVALZ](#) [ADP130-0.8-EVALZ](#) [ADP130-1.8-EVALZ](#) [ADP1740-1.5-EVALZ](#) [ADP1870-0.3-EVALZ](#) [ADP1874-0.3-EVALZ](#) [ADP199CB-EVALZ](#) [ADP2102-1.25-EVALZ](#) [ADP2102-1.875EVALZ](#) [ADP2102-1.8-EVALZ](#) [ADP2102-2-EVALZ](#) [ADP2102-3-EVALZ](#) [ADP2102-4-EVALZ](#) [AS3606-DB](#) [BQ25010EVM](#) [BQ3055EVM](#) [ISLUSBI2CKIT1Z](#) [LP38512TS-1.8EV](#) [EVAL-ADM1186-1MBZ](#) [EVAL-ADM1186-2MBZ](#) [ADP122UJZ-REDYKIT](#) [ADP166Z-REDYKIT](#) [ADP170-1.8-EVALZ](#) [ADP171-EVALZ](#) [ADP1853-EVALZ](#) [ADP1873-0.3-EVALZ](#) [ADP198CP-EVALZ](#) [ADP2102-1.0-EVALZ](#) [ADP2102-1-EVALZ](#) [ADP2107-1.8-EVALZ](#) [ADP5020CP-EVALZ](#) [CC-ACC-DBMX-51](#) [ATPL230A-EK](#) [MIC23250-S4YMT EV](#) [MIC26603YJL EV](#) [MIC33050-SYHL EV](#) [TPS60100EVM-131](#) [TPS65010EVM-230](#) [TPS71933-28EVM-213](#) [TPS72728YFFEVM-407](#) [TPS79318YEQEVM](#) [UCC28810EVM-002](#) [XILINXPWR-083](#) [LMR22007YMINI-EVM](#) [LP38501ATJ-EV](#)