

MAX86140/MAX86141 Evaluation System

Evaluates: MAX86140 and MAX86141

General Description

The MAX86140/MAX86141 Evaluation System (EVSYS) allows for the quick evaluation of the MAX86140 and MAX86141 optical AFE for applications at various sites on the body, particularly the wrist. Both MAX86140 and MAX86141 supports standard SPI compatible interface. MAX86140 consists of a single optical readout channels, while MAX86141 has two optical readout channels that operate simultaneously. The EVSYS allows flexible configurations to optimize measurement signal quality at minimal power consumption. The EVSYS helps the user quickly learn about how to configure and use the MAX86140 and MAX86141.

The EVSYS consists of three boards. MAXSensor BLEEK# is the main data acquisition board while MAX86140OSBEK# and MAX86141OSBEK# are the sensor daughter boards for MAX86140 and MAX86141 respectively. The EVSYS can be powered using the USB-C supply or LiPo Battery.

The EVSYS comes with a MAX86140ENP+/MAX86141-ENP+ in a 24-bump wafer-level package (WLP).

Features

- Quick Evaluation of the MAX86140/MAX86141
- Supports Optimization of Configurations
- Facilitates Understanding MAX86140/MAX86141 Architecture and Solution Strategy
- Real-time Monitoring
- Data Logging Capabilities
- On-Board Accelerometer
- Bluetooth LE

Ordering Information appears at end of data sheet.

Quick Start

Required Equipment

- MAX86140 EVSYS
- Data Acquisition EVSYS Micro-PCB (MAXSensorBLEEK#)
- MAX86140 EVSYS Sensor PCB (MAX86140OSBEK#)
- MAX86141 EVSYS Sensor PCB (MAX86141OSBEK#)
- Flex cable
- USB-C cable
- MAX86140 EVSYS GUI Software
- MAX86140 Parser and User guide (included in MAX86140GUISetupVxxx.ZIP)
- Windows PC
- Required Bluetooth LE Dongle [CY5677](#) or [CY5670](#) (not shipped with EVSYS)
- Optional LiPo Battery ([LP-401230](#) suggested, not shipped with EVSYS)

Note: If you do not already have one of the listed BLE dongles above, purchasing one is recommended.

Procedure

- 1) The EVSYS is fully assembled and tested. Follow the steps below to verify board operation:
Visit www.maximintegrated.com/evkit-software to download the most recent version of the EVSYS software, MAX86140GUISetupVxxx_Web.ZIP. Save the EVSYS software to a temporary folder and decompress the ZIP file.
- 2) Plugged in the BLE dongle to one of the USB port on the PC.
- 3) Open up MAX86140GUISetupVxxx.exe and follow the instructions from the pop-up windows, as shown in [Figure 1](#) to [Figure 7](#).
- 4) The BLE Dongle driver installation will also be completed after the GUI installation, as shown in [Figure 8](#).
- 5) If the MAX86140 EVSYS flex cable is not already connecting the Data Acquisition EVSYS Micro PCB to the MAX86140 or MAX86141 Sensor PCB, then please connect the two PCBs with the cable as shown in [Figure 9](#) and [Figure 10](#) or [Figure 11](#) and [Figure 12](#).

MAX86140/MAX86141 Evaluation System

Evaluates: MAX86140 and MAX86141

- 6) Connect USB-C cable or LiPo Battery to the Data Acquisition Board to power up the EVSYS. If LiPo battery is used, press the power switch (SW) to turn on/off the device. When powered on, the green LED will toggle.
- 7) After that, start the MAX86140 EVSYS GUI program. "Connect Device" will appear, choose your device and press "Connect" as shown in [Figure 11](#).
- 8) The GUI will then be launched as shown in [Figure 12](#).
- 9) Configure the EVSYS on the GUI and Click on the <Start> button on the bottom left side to start the data acquisition.
- 10) When running, the LEDs on the Micro PCB should illuminate and the plots on the GUI should stream with data as shown in [Figure 13](#) and [Figure 14](#).

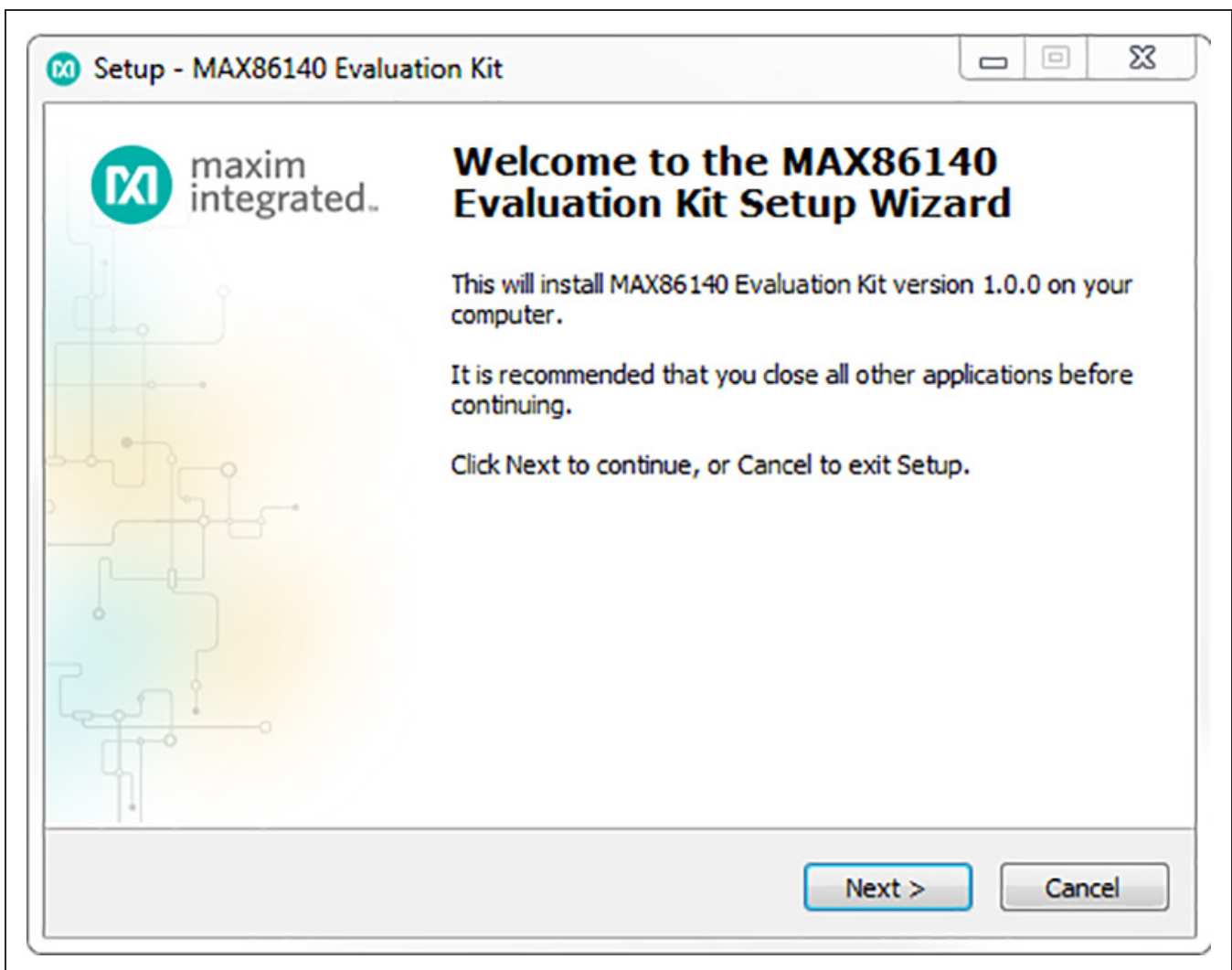

Figure 1. Setup MAX86140 EVSYS GUI Software Step 1

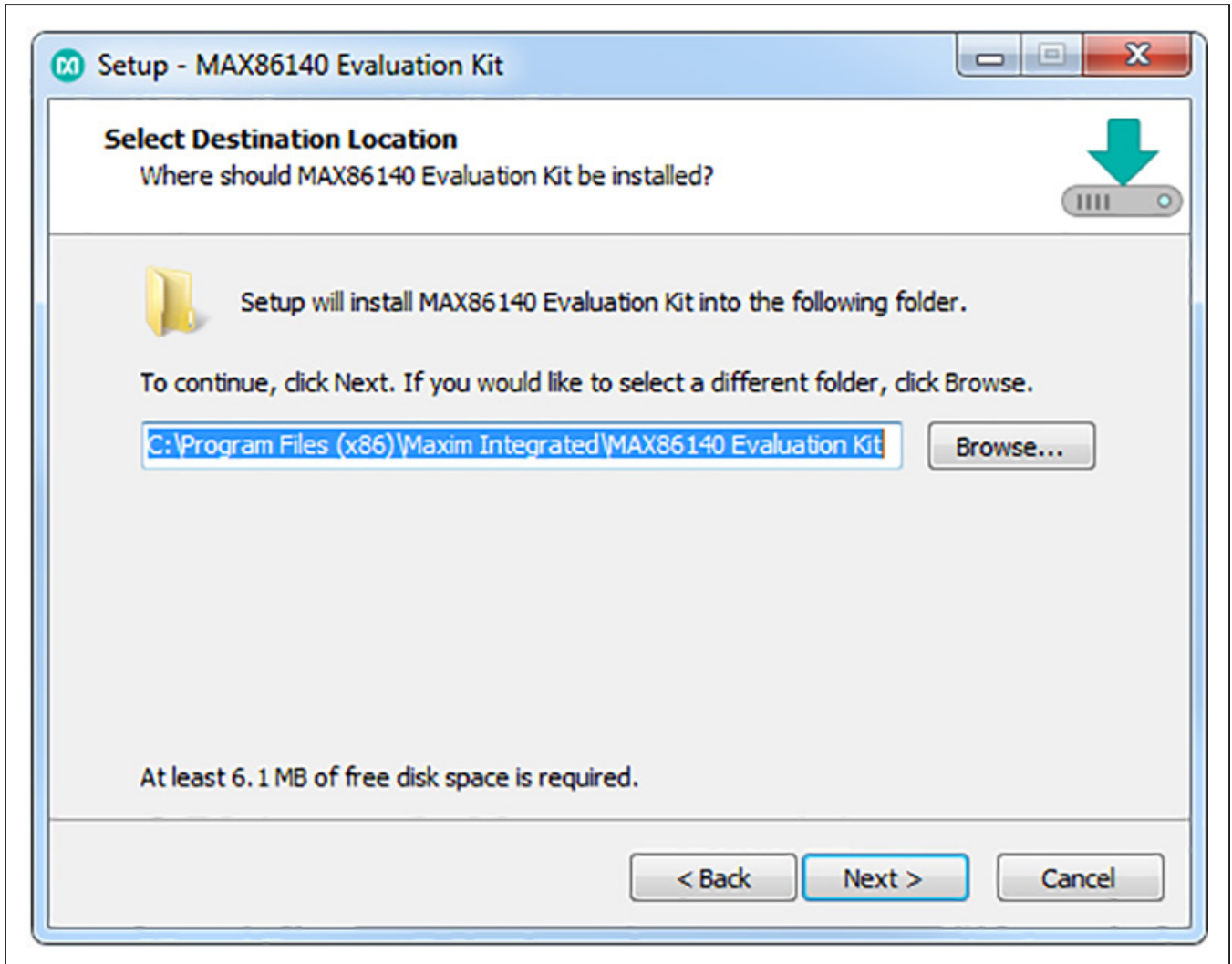

Figure 2. Setup MAX86140 EVSYS GUI Software Step 2

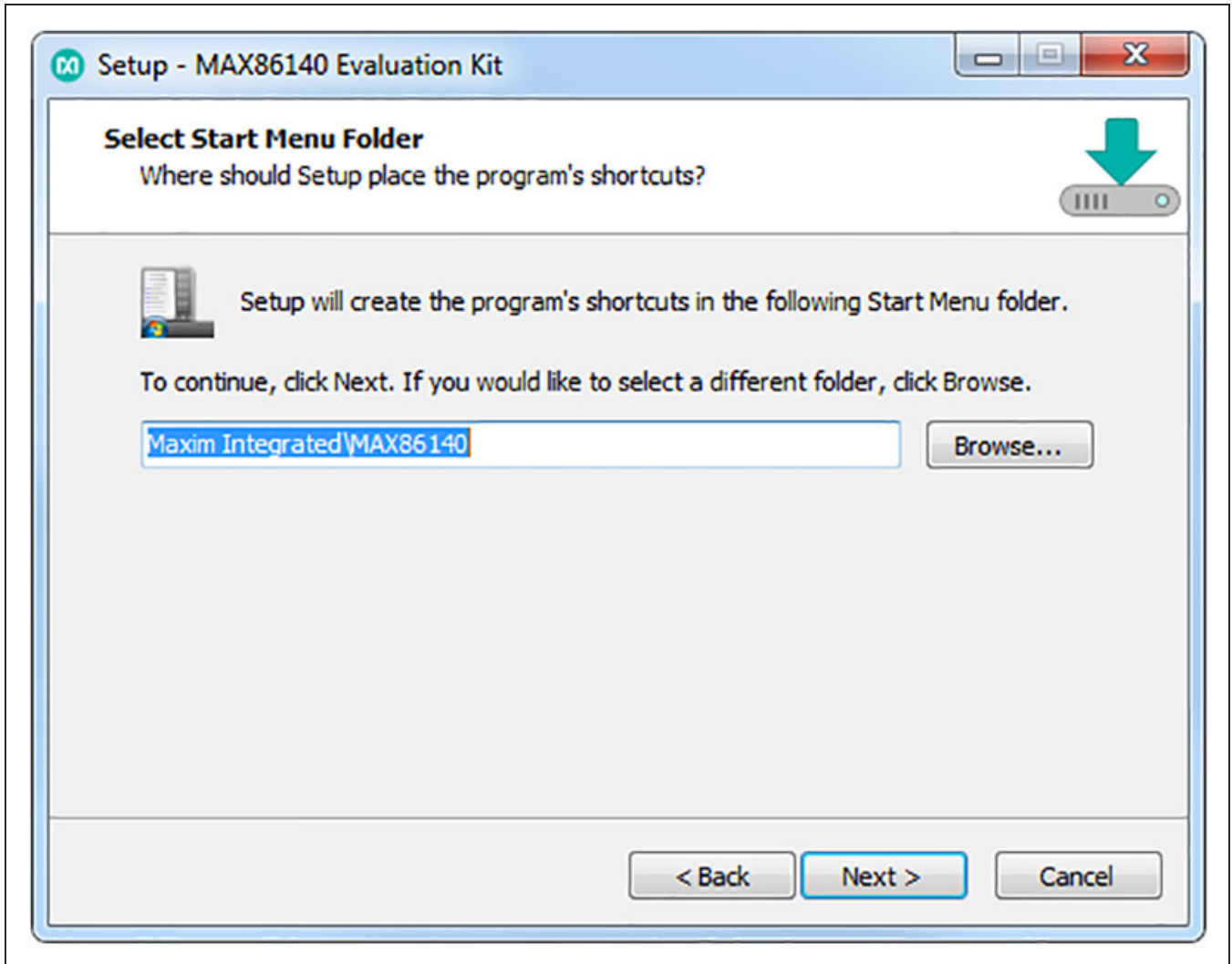

Figure 3. Setup MAX86140 EVSYS GUI Software Step 3

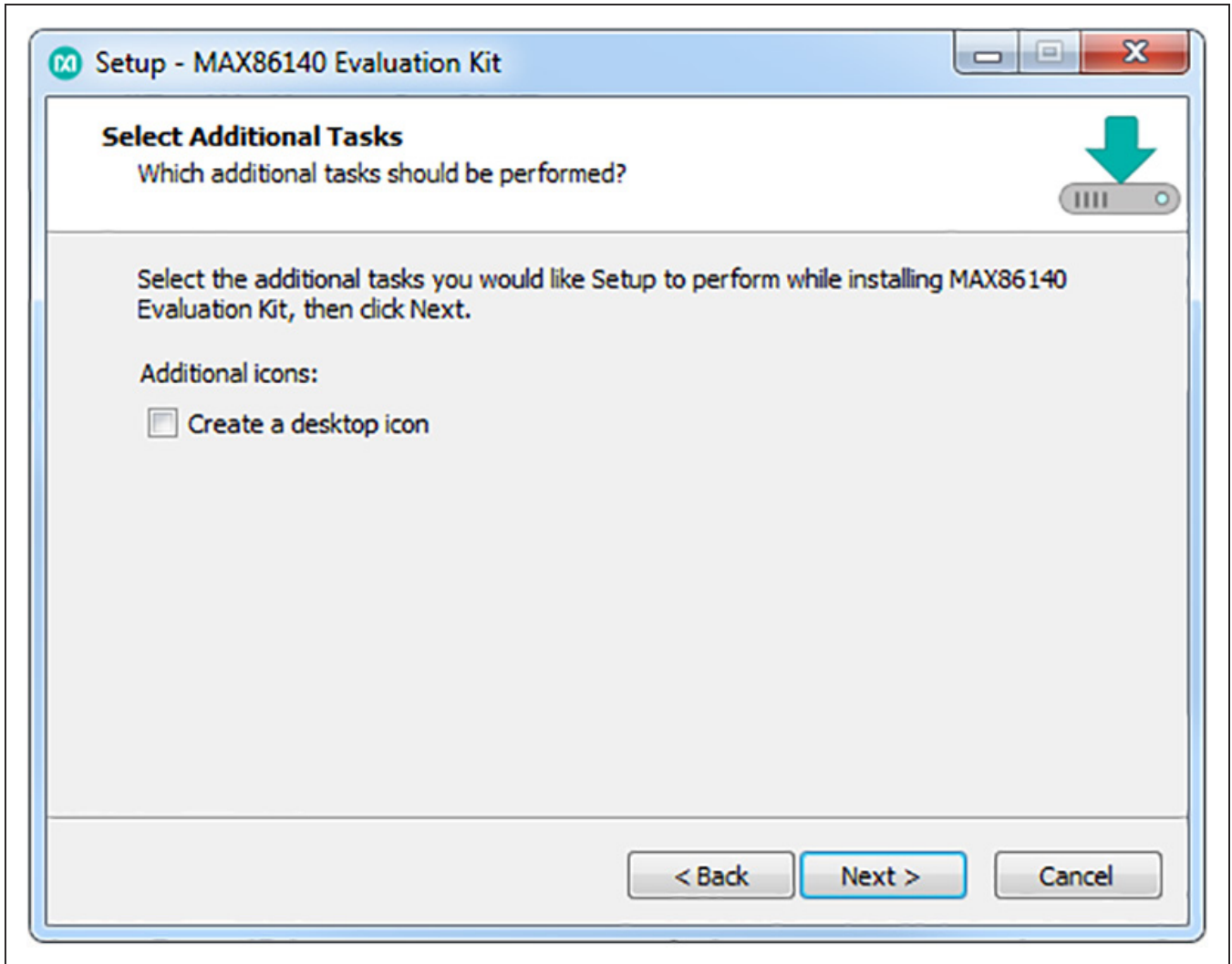

Figure 4. Setup MAX86140 EVSYS GUI Software Step 4

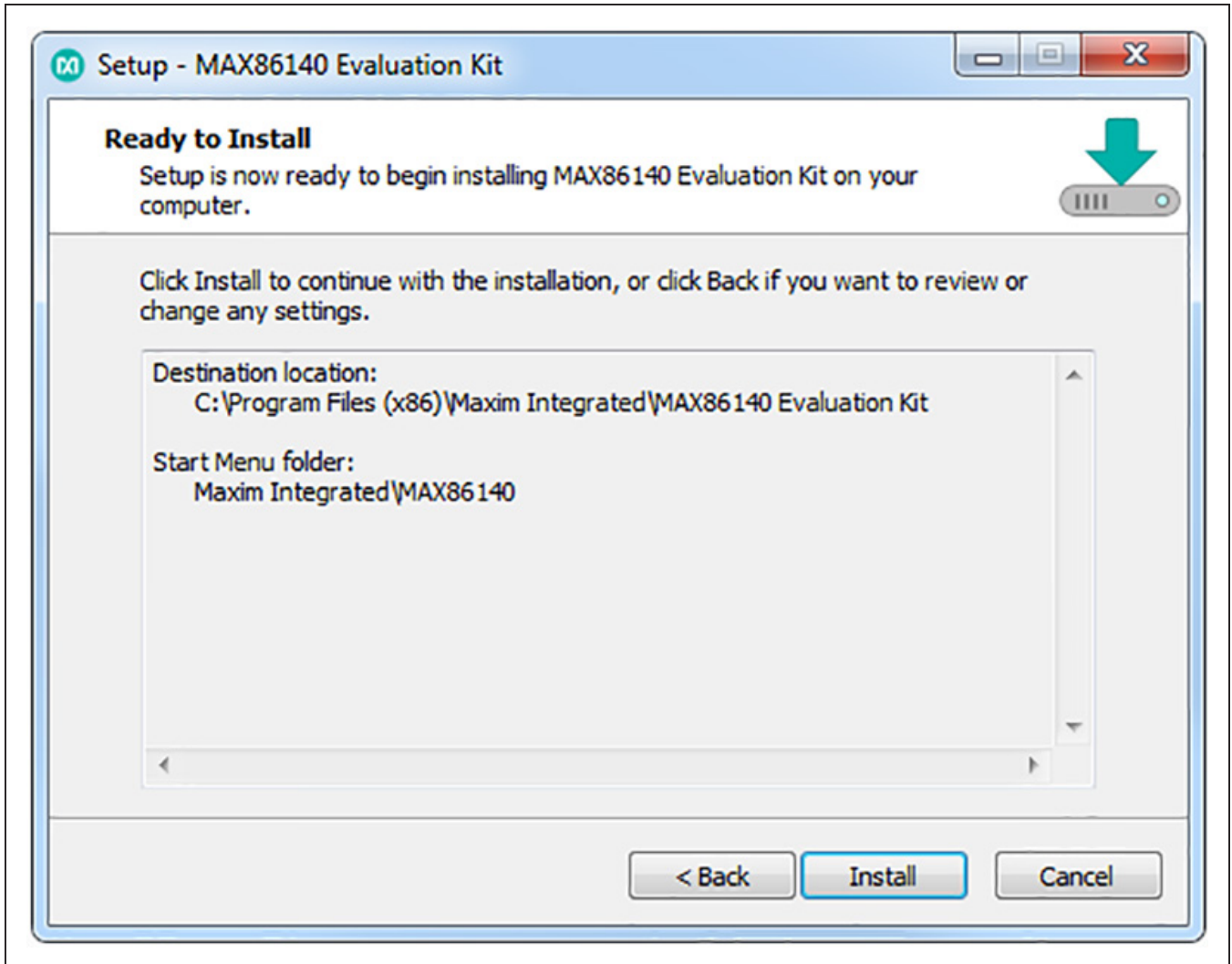

Figure 5. Setup MAX86140 EVSYS GUI Software Step 5

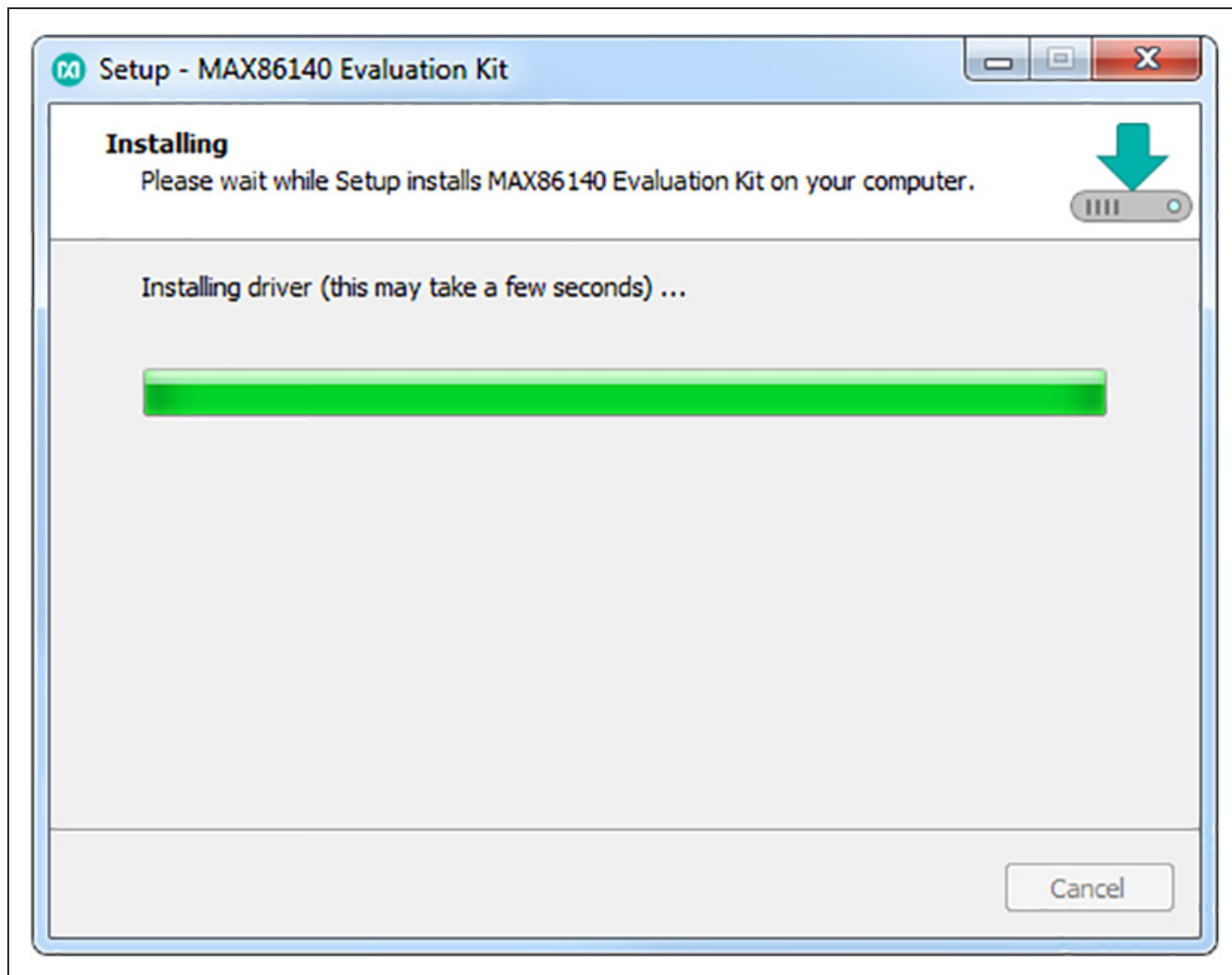

Figure 6. Setup MAX86140 EVSYS GUI Software Step 6

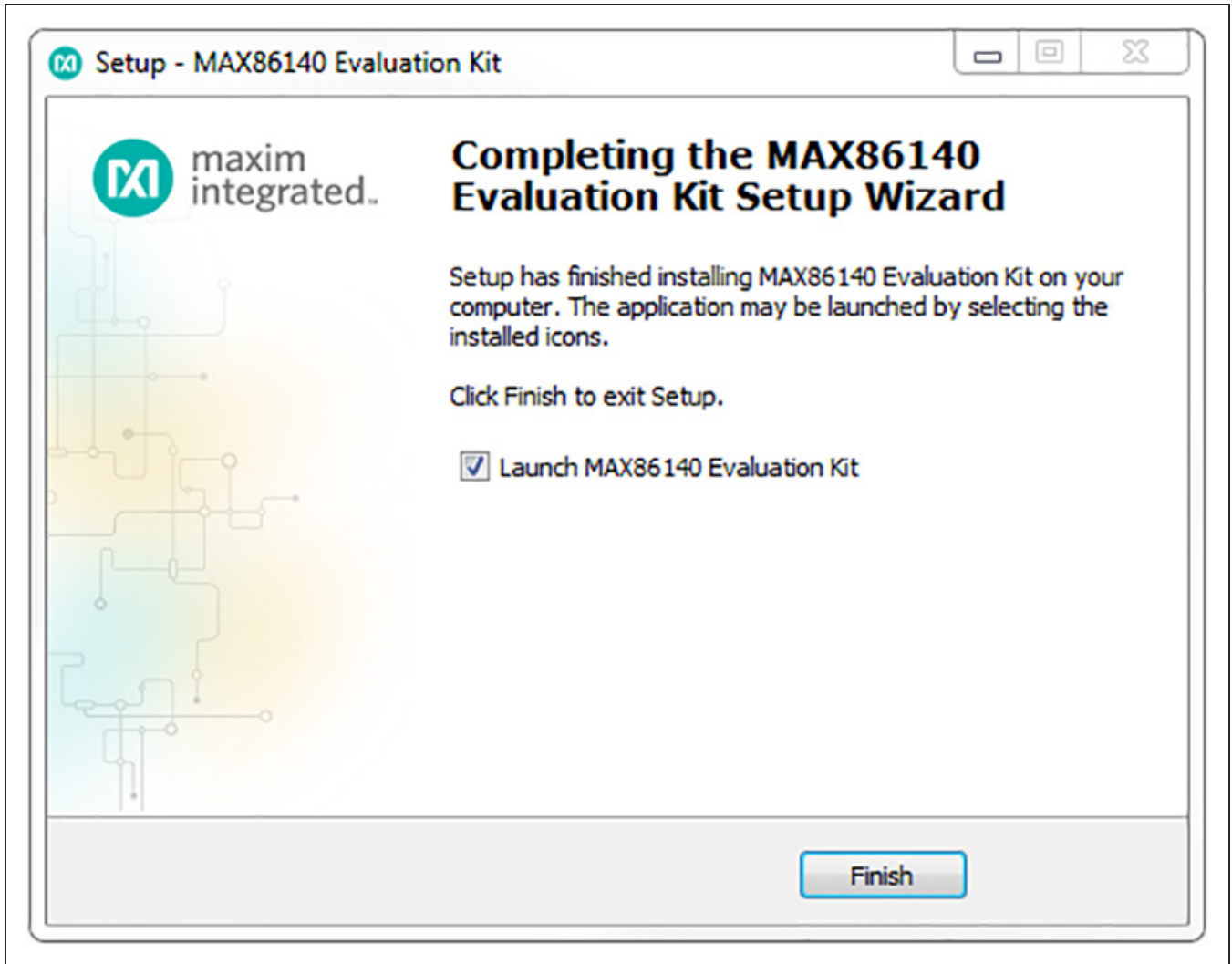

Figure 7. Setup MAX86140 EVSYS GUI Software Step 7

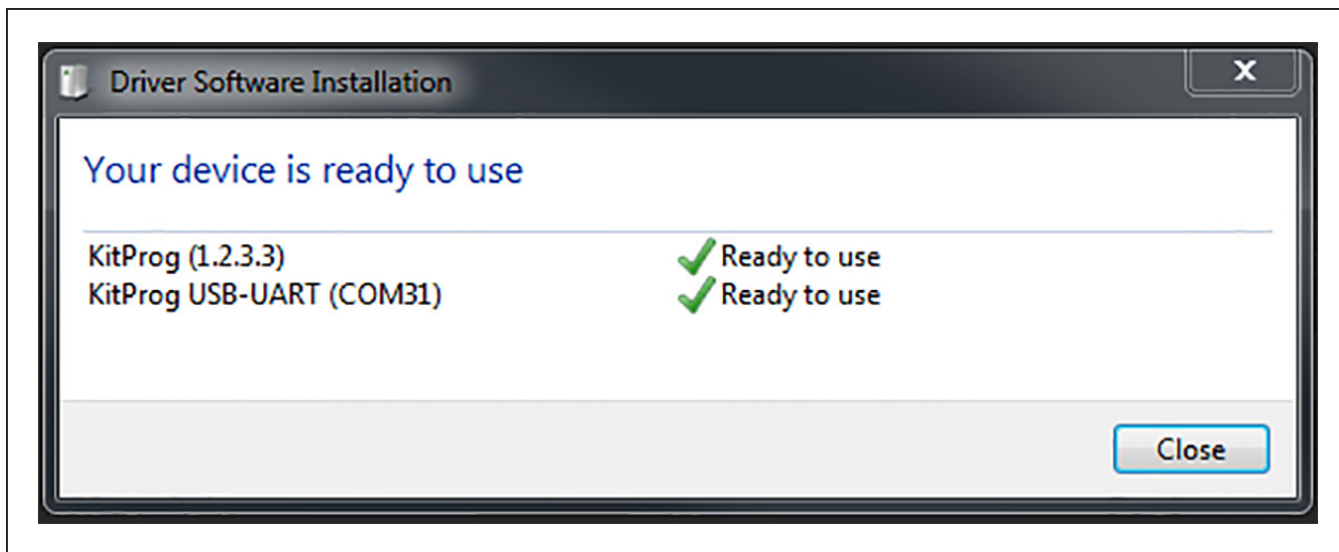

Figure 8. BLE Dongle Driver Installation

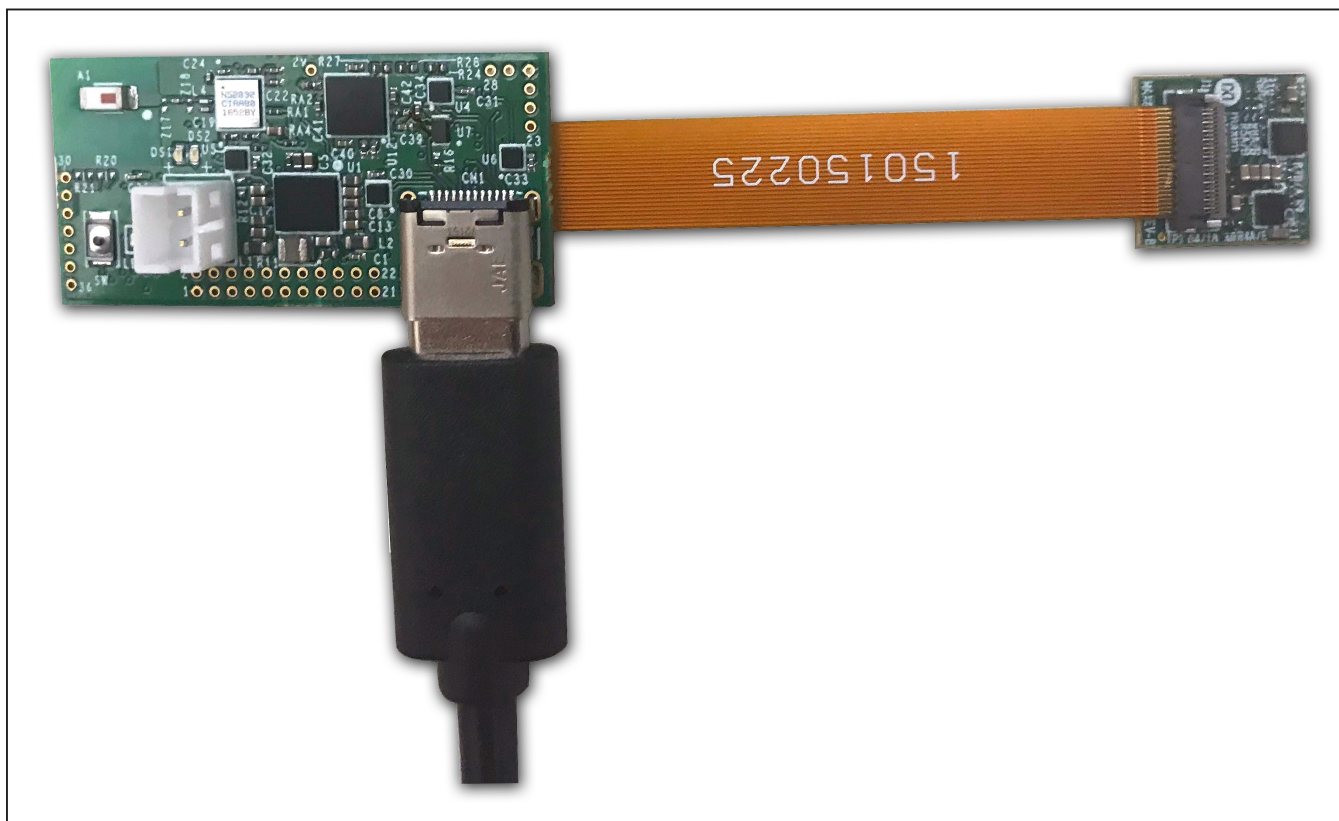

Figure 9. Hardware Setup (MAX86140 EVSYS Micro-PCB)

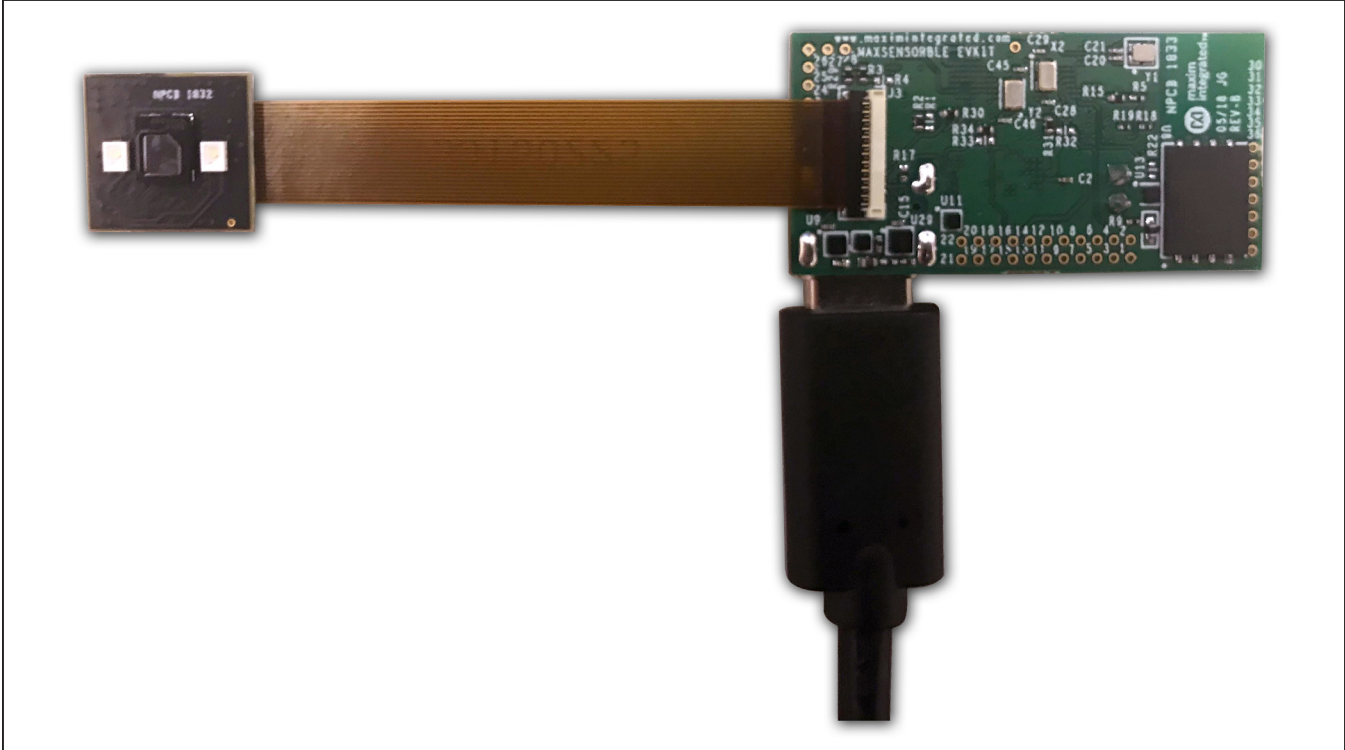

Figure 10. Hardware Setup (MAX86140 EVSYS Sensor PCB)

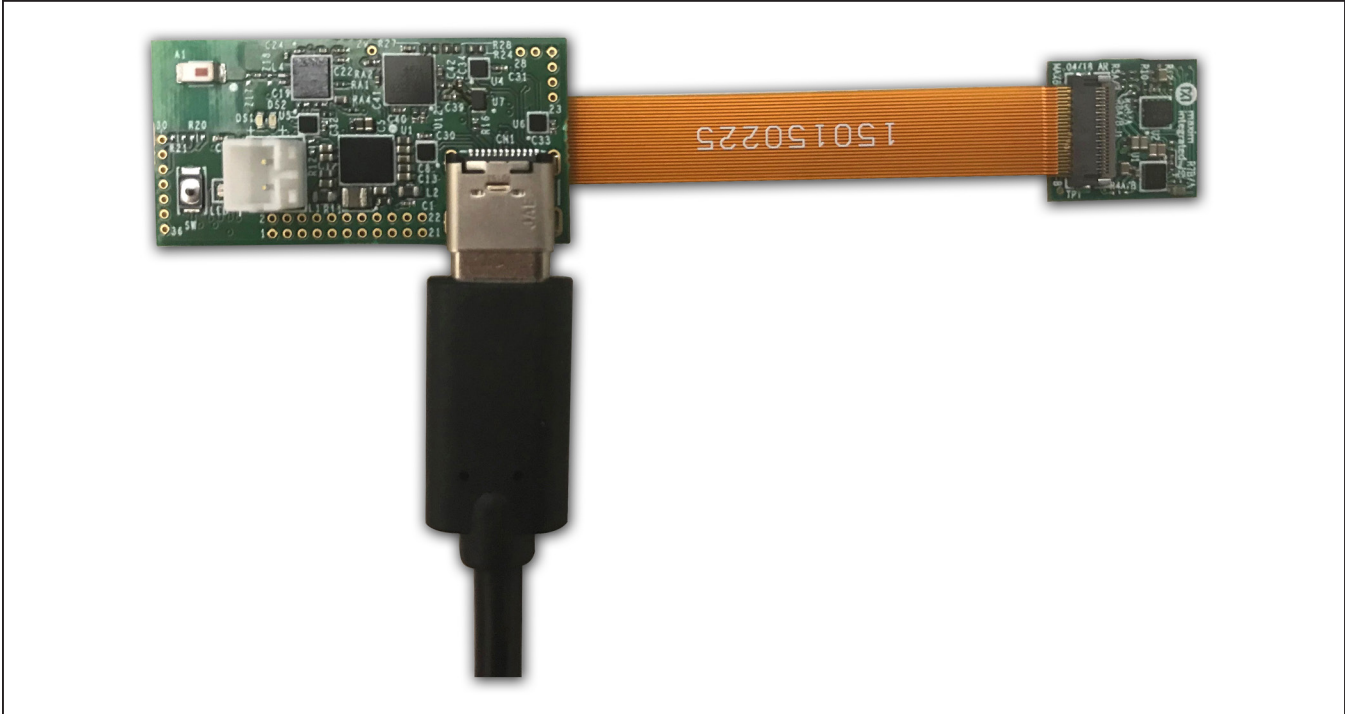

Figure 11. Hardware Setup (MAX86141 EVSYS Micro PCB)

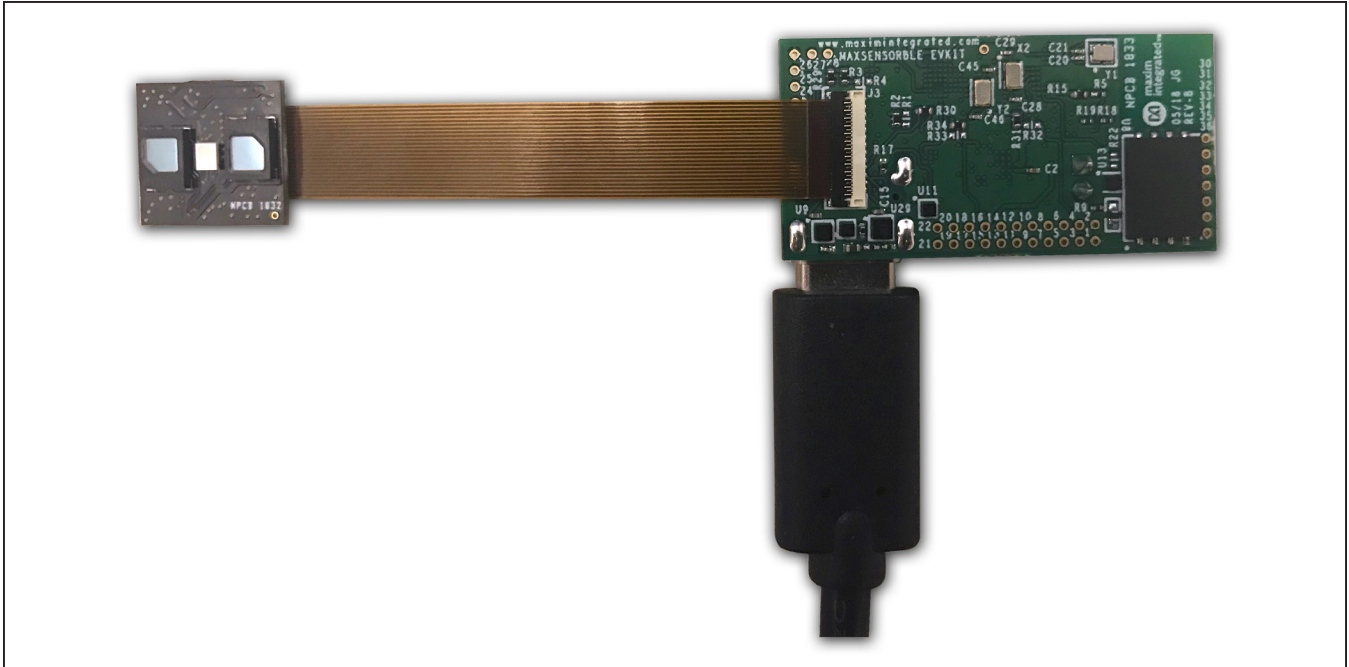

Figure 12. Hardware Setup (MAX86141 EVSYS Sensor PCB)

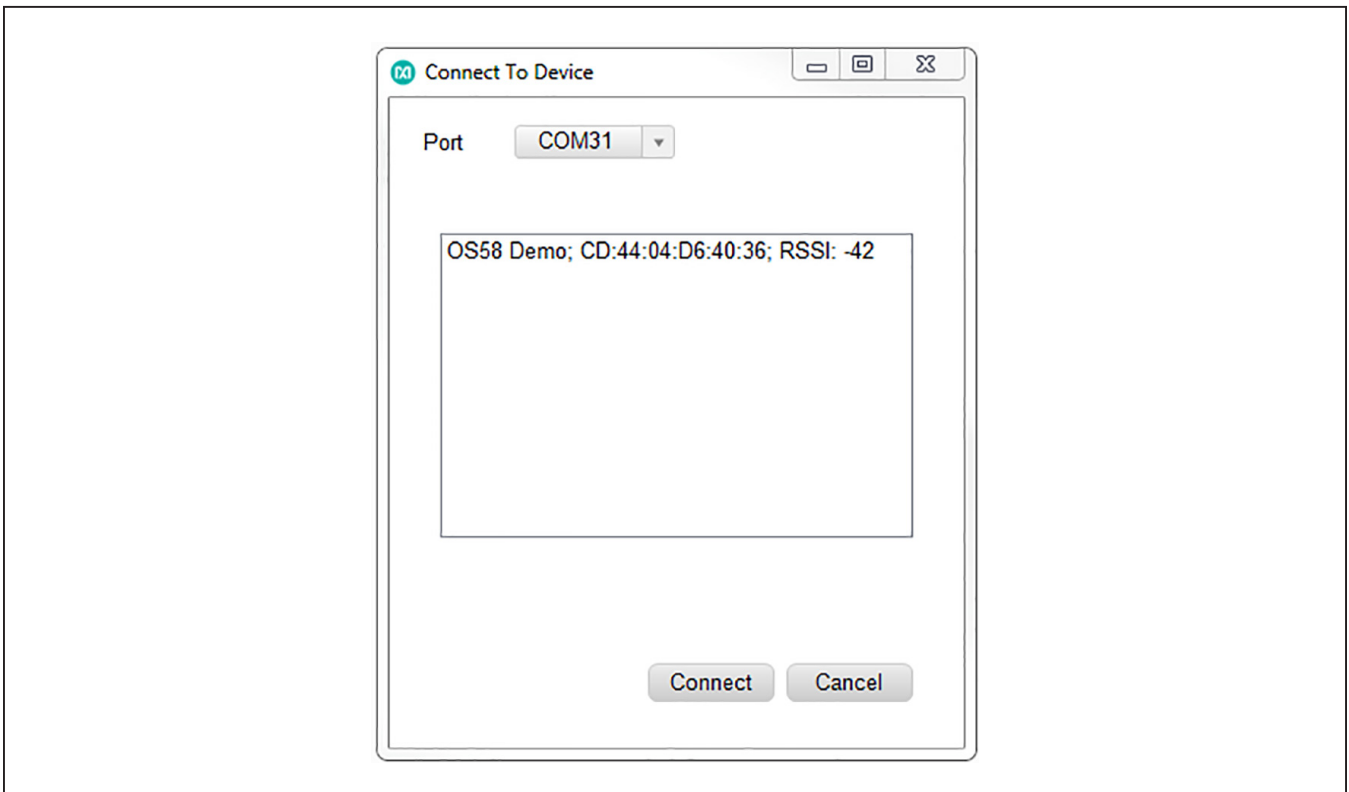

Figure 13. Connect to BLE Device

MAX86140/MAX86141 Evaluation System

Evaluates: MAX86140 and MAX86141

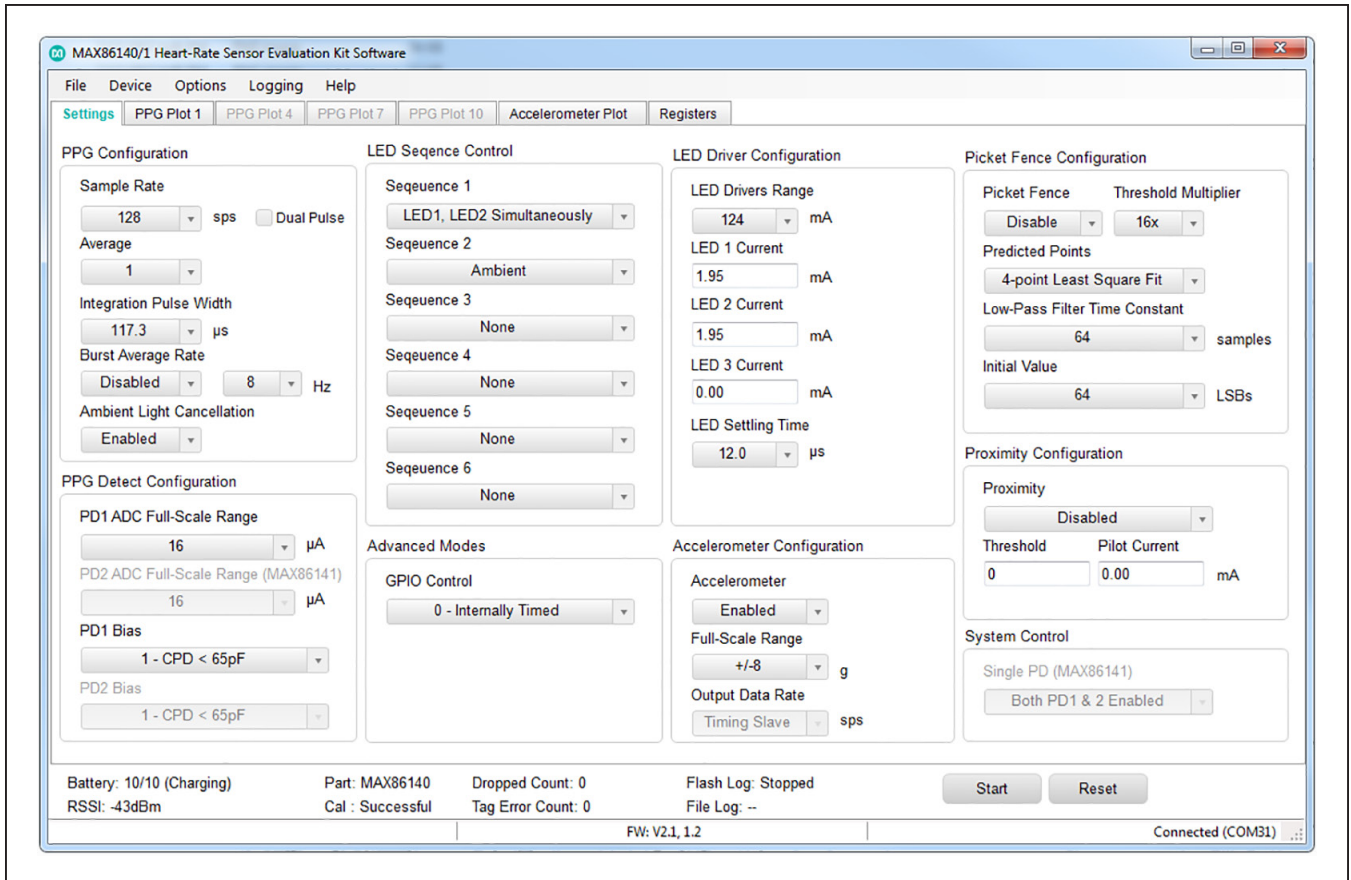

Figure 14. MAX86140 EVSYS GUI

MAX86140/MAX86141 Evaluation System

Evaluates: MAX86140 and MAX86141

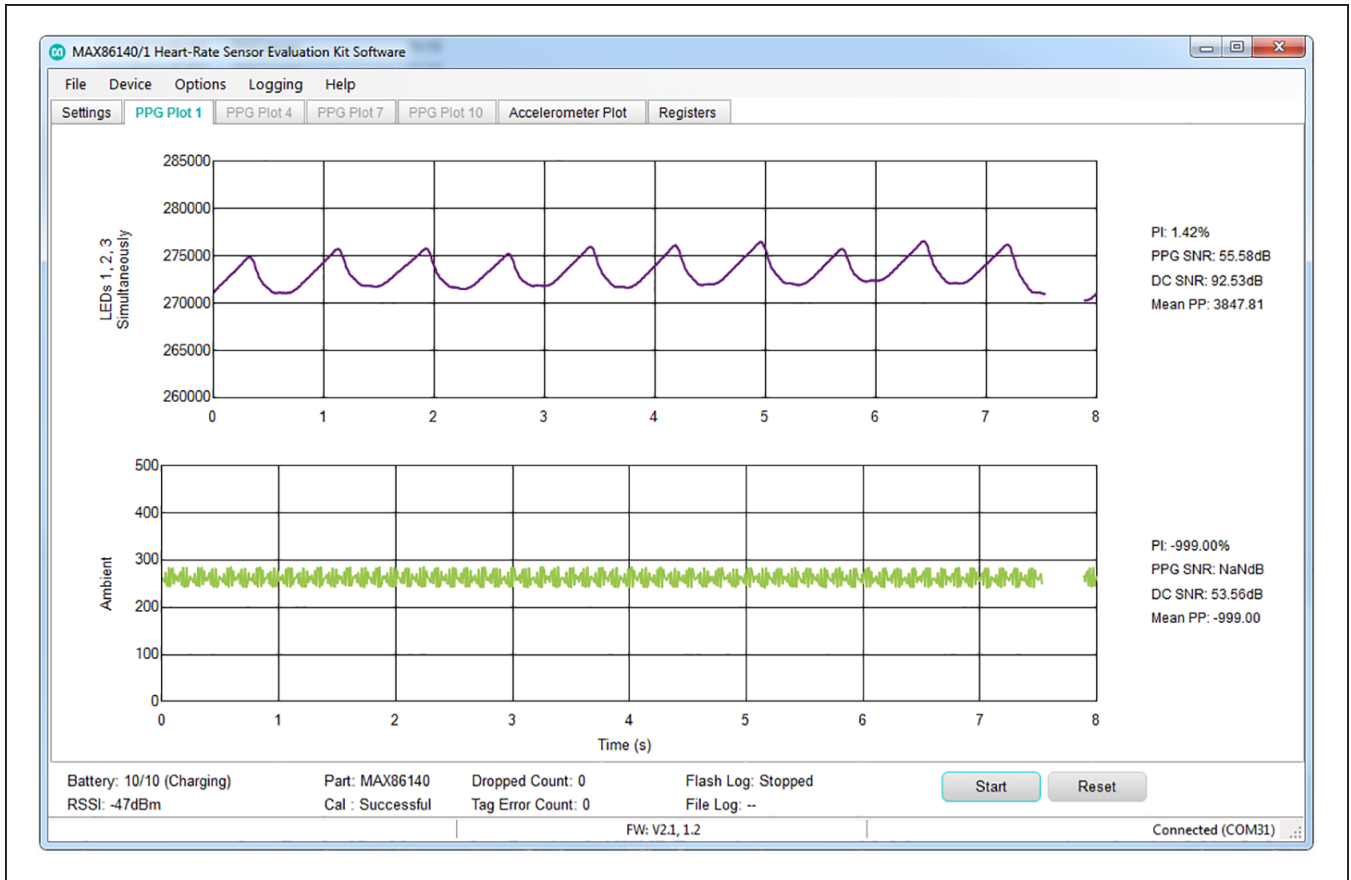

Figure 15. MAX86140 EVSYS GUI (PPG Plots)

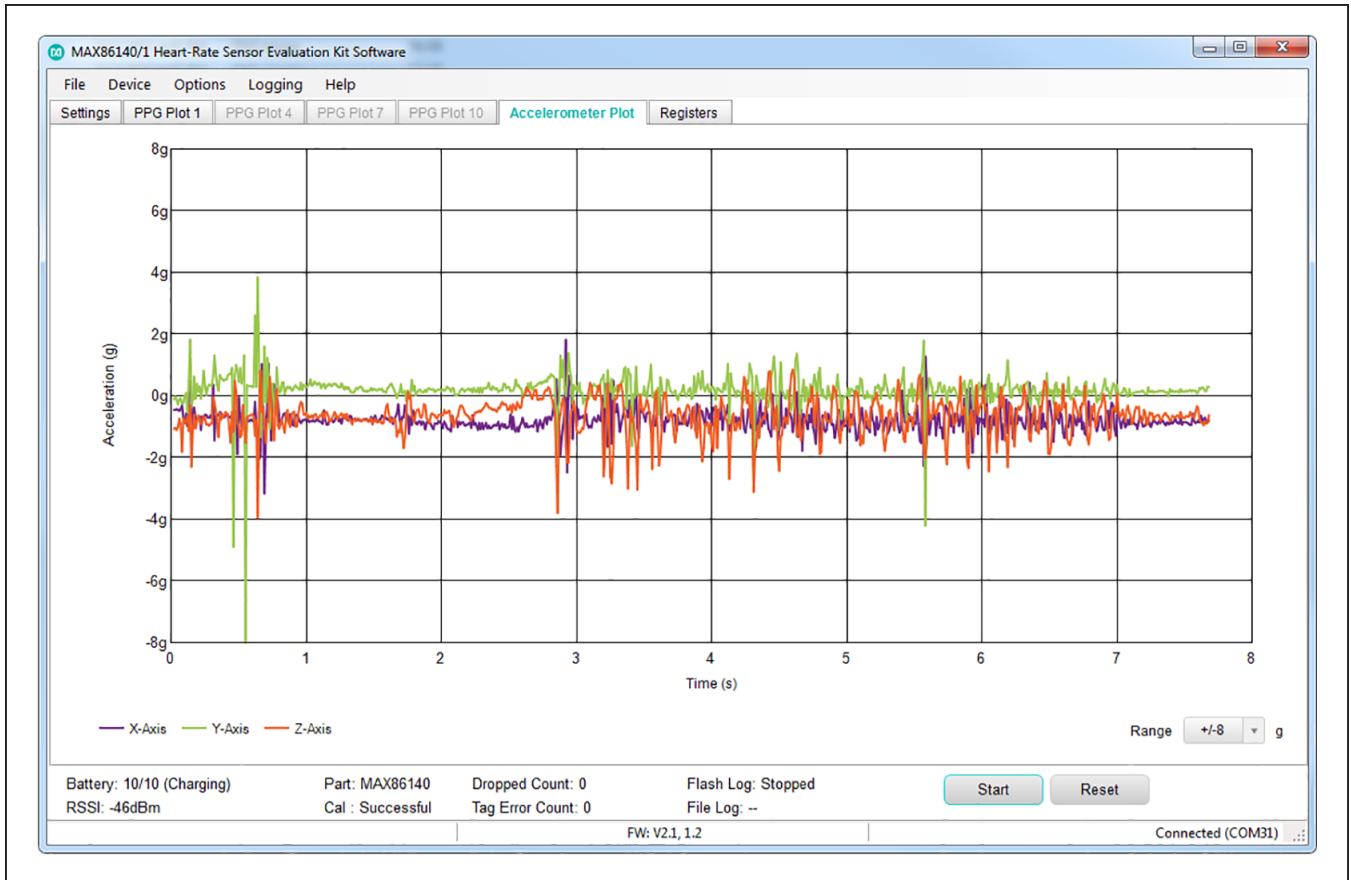

Figure 16. MAX86140 EVSYS GUI (Accelerometer Plots)

MAX86140/MAX86141 Evaluation System

Detailed Description of Software

The EVSYS includes two sensor PCBs. Each contains MAX86140/MAX86141 optical AFE, a 3-axis accelerometer together with a photodiode(s) and LED(s). MAX86140_OS_B_EVSYS comes with a discreet photodiode (VEMD5080X01) and two green LEDs (Osram CT DBLP31.12-5C8C-56-J6Q6), while MAX86141_OS_B_EVSYS comes with two discreet photodiodes (VEMD5080X01), and a green LED (Osram CT DBLP31.12-5C8C-56-J6Q6). The EVSYS allows raw optical and accelerometer data to be sampled and transferred to the GUI for both dynamic viewing and logging for later analysis. The EVSYS micro controller PCB is used to do SPI to BLE communication, transporting the raw optical and accelerometer data to the PC via BLE.

Most functionality of the MAX86140/MAX86141 has been mapped to the GUI so the wide variety of applications supported by the MAX86140/MAX86141 can be rapidly explored. The following is a brief description of this functionality options.

Sample Rate

The sample rate can take on values between 8 to 4096sps. The dual pulse mode option are modes where the samples are unevenly spaced and averaged to improve the ambient rejection of mains line rate ambient signals.

Table 1 and Table 2 shows the maximum supported sampling rates (in Sps) for the MAX86140 and MAX86141 respectively for the given number of exposure sequences and use of accelerometer. The maximum sample rate is limited by the BLE protocol, not the AFE itself.

For a given sample rate, the number listed can be increased to the next available MAX86140/MAX86141 sample rate (i.e., 500Sps → 512Sps).

Integration Pulse Width

The pulse width setting adjusts the integration time of an exposure. The MAX86140\MAX86141 supports exposure integration times of 14.8µs, 29.4µs, 58.7µs, and 117.3µs. The exposure pulse width is a critical parameter in any optical measurement. Longer exposures allow for more optical photons to be integrated but also increase system power and reduce ambient rejection capability.

Burst Rate

When Burst Mode is disabled, PPG data conversions are continuous at the sample rate defined by PPG_SR register, When Burst mode is enabled, a burst of PPG data conversions occurs at the sample rate defined by

Evaluates: MAX86140 and MAX86141

Sample Rate (PPG_SR) register. Number of conversion in the burst is defined by the SMP_AVE register. Average data from the burst of data conversions is pushed to the FIFO at the rate of burst average rate. The burst repeats at the rate of 8, 32, 84, or 256Hz can be configured in burst average field. The burst average rate field defines the rate at which data is pushed into the FIFO. If the number of conversions cannot be accommodated, the device will use the next highest number of conversions. If the effective sample rate is too slow to accommodate the burst rate programmed, BURST_EN is automatically set to 0, and the device runs in continuous mode.

Ambient Light Cancellation

The on-chip Ambient Light Cancellation incorporates a proprietary scheme to cancel ambient light generated photo diode current, allowing the sensor to work in high ambient light conditions.

ADC Full-Scale Range

The MAX86140\MAX86141 optical channel has 4 full-scale ranges. These ranges are 4µA, 8µA, 16µA, and 32µA.

Table 1. MAX86140 Max Sample Rates (Sps)

ACCELEROMETER # OF SEQUENCES	WITH	WITHOUT
1	500	1000
2	500	1000
3	250	500
4	250	500
5	125	250
6	125	250

Table 2. MAX86141 Max Sample Rates (Sps)

ACCELEROMETER # OF SEQUENCES	WITH	WITHOUT
1	500	1000
2	250	500
3	125	250
4	125	125
5	125	125
6	62.5	125

MAX86140/MAX86141 Evaluation System

Sample Average

The MAX86140\MAX86141 has the capability to do sample averaging of 2 ~ 128 samples internally. This feature is useful if more optical energy is needed to make a low perfusion measurement but the data rate across the interface or the processing power in a host micro is not desirable. This mode is also useful to further suppress the mains line noises in indoor lighting conditions.

PD Bias

The MAX86140\MAX86141 provides multiple photo diode biasing options. These options allow the MAX86140\MAX86141 to operate with a large range of photo diode capacitance. The PDBIAS values adjust the PD_IN bias point impedance to ensure that the photo diode settles rapidly enough to support the sample timing. PDBIAS is configured depending on the Capacitance (CPD) of the photodiode used.

Note: PD2 configuration is only available for MAX86141.

LED Sequence Control (FIFO Time Slots)

The LED Sequence Control specifies the data acquisition sequence that the internal state machine controller will follow and where the converted data will be mapped into the FIFO.

Each FIFO field can be applied to one measurement. Acquired data can be from LED1, LED2, or LED3 (optical exposure from LED1~3) illuminated independently. The LED1&LED2, LED1&LED3, LED2&LED3, and LED1&LED2&LED3 are optical exposures from LEDs illuminated simultaneously. The other options are Ambient (optical data with no exposure, just ambient illumination) or None (skip this acquisition). The LED4-6 (Mux Control) are not supported with the sensor PCB. If a custom sensor board with MUX is used, LED4, LED5 and LED6 can also be configured. Only LED1 and LED2 are available in this EVSYS.

The exposure sequence will be the entry in Sequence 1 (LEDC1) slot, Sequence 2 (LEDC 2) slot, Sequence 3 (LEDC3), Sequence 4 (LEDC4), Sequence 5 (LEDC5) slot then Sequence 6 (LEDC6) slot. This sequence will repeat for each sample instance. Each Sequence if programmed, will be plot in the PPG Plot x tabs respectively as shown in [Figure 15](#).

Please refer to the MAX86140/MAX86141 datasheet under FIFO Configuration Section for details.

Evaluates: MAX86140 and MAX86141

LED Driver Configurations

Each of the three LED drivers has a Range and Peak LED Current setting. There are 4 full-scale range settings 31mA, 62mA, 93mA and 124mA. Each range has an 8-bit current source DAC. The Peak LED Current box allows for an actual current to be entered. The nearest available DAC current is selected and displayed in the field.

LED Settling Time

The LED Settling Time is the time prior to the start of integration (pulse-width setting) that the LED is turned on. There are four settlings, 12 μ s, 8 μ s, 6 μ s and 4 μ s. This time is necessary to allow the LED driver to settle before integrating the exposure photo current.

GPIO Control

Various options of GPIO controls are available on MAX86140. For the EVSYS, when set to GPIO options 2, the sample rate will be triggered by the on-board accelerometer.

Please refer to the MAX86140/MAX86141 datasheet under GPIO Configuration Section for details.

Accelerometer Configuration

The on-board accelerometer can be enabled or disabled by using the GUI. Supported accelerometer Full-Scale Range are $\pm 2g$, $\pm 4g$, $\pm 8g$ and $\pm 16g$. The output data of the accelerometer can also be configured from 15.63Hz to 2000Hz when used with GPIO Control Option 2.

Picket Fence Configuration

Under typical situations, the rate of change of ambient light is such that the ambient signal level during exposure can be accurately predicted and high levels of ambient rejection are obtained. However, it is possible to have situations where the ambient light level changes extremely rapidly, for example when in a car with direct sunlight exposure passes under a bridge and into a dark shadow. In these situations, it is possible for the on-chip ambient light correction (ALC) circuit to fail and produce and erroneous estimation of the ambient light during the exposure interval. The optical controller has a built-in algorithm, called the picket fence function, that can correct for these extreme conditions on the ALC circuit.

Please refer to the MAX86140/MAX86141 datasheet under Picket Fence Detect-and-Replace Function Section for details.

MAX86140/MAX86141 Evaluation System

Evaluates: MAX86140 and MAX86141

Proximity Configuration

The optical controller also includes an optical proximity function which could significantly reduce energy consumption and extend battery life when the sensor is not in contact with the skin.

Please refer to the MAX86140/MAX86141 datasheet under Proximity Mode Section for details.

System Control

When MAX86141 is used, there is option to use single PD (PD1) or Dual PD simultaneously (PD1 and PD2). When Dual PD mode is used, the data log will show data from both PD for each configured sequence.

<Start >/<Stop > Button

The <Start Monitor> button is used to start data acquisition from the demo. The <Start Monitor> button will only be effective when the EVSYS is connected and detected. Once the <Start > has been pushed the <Stop> button appears, which can be used to stop the acquisition. Once the acquisition has started, all settings are locked. Terminate the acquisition to change any settling.

<Reset> Button

The <Reset> button will clear out all register settings back to the programs start up.

Data Logging

Raw optical and accelerometer data can be logged from the <Logging> pull-down menu item. There are two options available: Data saved to file or in the flash. When "file" data logging is selected, the GUI asks for a folder location where the logging file will be saved. Create a new folder or accept the default. Data logging will start on the next <Start> button and will continue until the <Stop > button is pressed. The final file write is only done when the <File> pull-down menu item is accessed and the data-logging button is pressed.

Flash logging allows raw sensor data to be stored to the integrated 32MB flash memory chip in a binary file format. The max duration for flash logging is dependent on: sample rate, number of optical channels, and use of accelerometer.

The GUI enables/disables flash logging. The GUI can be disconnected while flash logging, allowing for remote operation (PPG Plots not available). Preparing the flash memory can take up to 30s after enabling. If the flash memory fills or battery power drops too low, flash logging will automatically stop and the file will close. Only one file can be saved at a time. The file must be downloaded since it will be erased on the next log request.

If a log has completed, a binary file will be found on the device. The binary log file must be downloaded via the USB-C cable; it cannot be downloaded through BLE. When the device is plugged into the PC, it enumerates as a USB mass storage device. However, the file can only be copied from this device. No other operations (such as deleting or saving other files) will work on this device. Copy the file to a local PC volume. Then run the parser to generate a CSV file.

Please refer to the Evaluation Kit Parser User Guide (max8614x demo + eval kit parser user guide 20170719.pdf) for details operation.

Register Map Access

Under the <Register> Tab the user can access to sensor register map as shown in [Figure 17](#). Press <Read All>, to read all the register value currently in configured in the Optical AFE. Bolded font bits are logic one. Normal font bits are logic zero. Click on the bits to toggle their value and click on <W> to write the value to the device. The register value does not change until <W> is clicked. Click <R> to read the register value to verify the write.

MAX86140/MAX86141 Evaluation System

Evaluates: MAX86140 and MAX86141

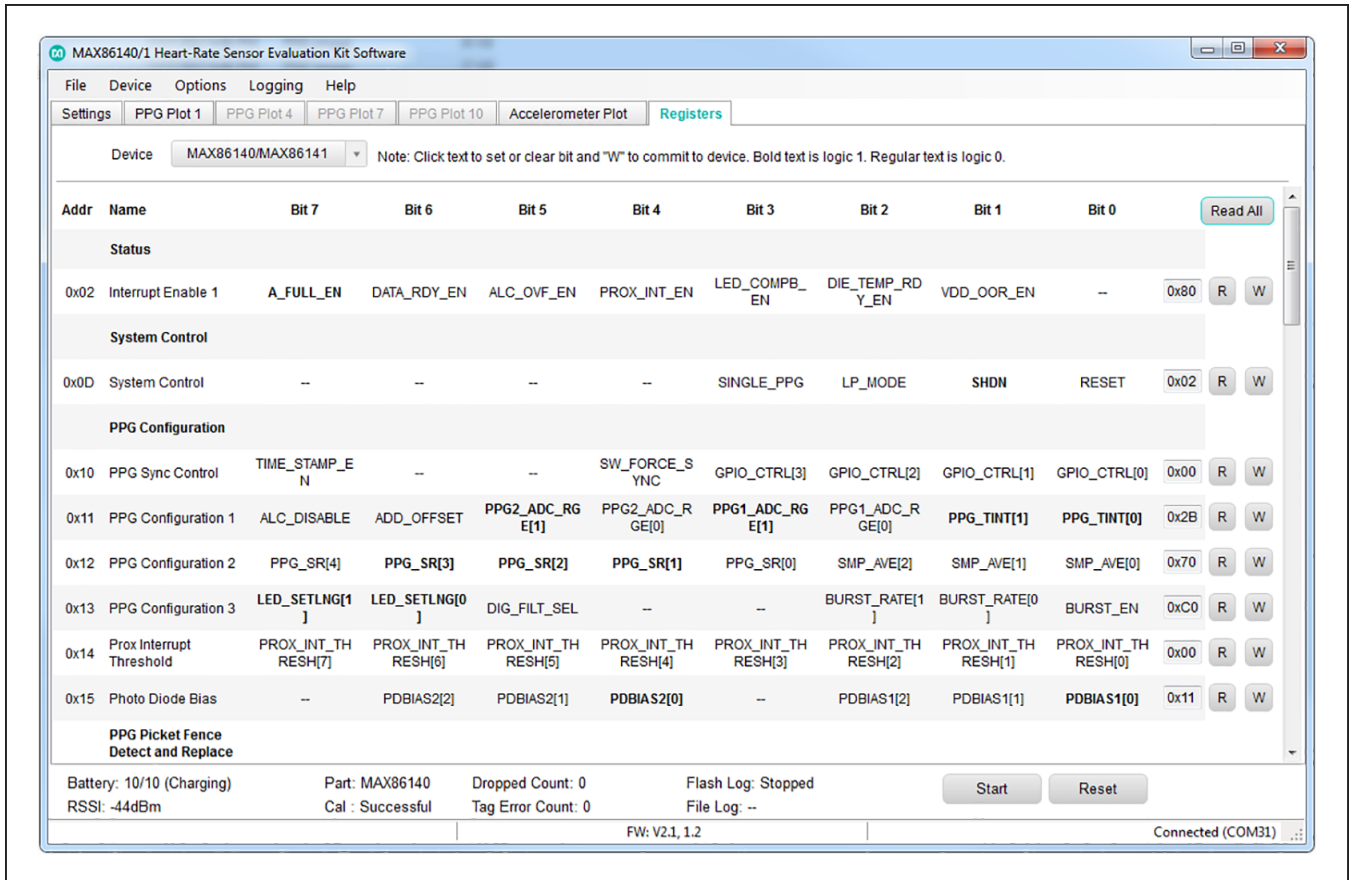

Figure 17. Register Map Access

MAX86140/MAX86141 Evaluation System

Evaluates: MAX86140 and MAX86141

Detailed Description of Hardware

Status LED Indicators

The onboard tri-color LEDs are use as status indicator.

LED Green

Toggling (1Hz 50% duty cycle) = BLE advertising

Toggling (1Hz 10% duty cycle) = BLE connected

LED Red

USB-C cable connected to charger

On = charging

Off = charge complete

Flash Logging

On = busy preparing the flash memory or flash memory is full

Toggling (synchronously with the green LED) = logging

Off = not logging

Note that flash logging indication takes precedence over the charging indication. I.e., if the device is plugged into a charger, the red LED indicates charge status. If flash logging is enabled while plugged into the charger, the red LED indicates flash log status.

Power Switch

Press the power switch (SW) to turn on/off the device. When powered on, the green LED will toggle per the LED indicator section. When powered off, the green LED will go out. The red LED may light temporarily, indicating that the flash log is closing. Plugging in the USB-C cable will also power up the device.

Battery/Charging

Use the USB-C cable to charge the integrated single-cell LiPo battery. The integrated PMIC initiates and stops charging automatically. Charge status is indicated through the red LED and GUI.

Ordering Information

PART	TYPE
MAX86140EVSYS#	EVSYS

#Denotes RoHS compliant.

Component List

MAX86140 EVSYS

PART	QTY	DESCRIPTION
MAXSensorBLE_EVKIT	1	MAX86140 EVSYS μ C PCB
MAX86140OSB_EVKIT	1	MAX86140 EVSYS Sensor PCB
MAX86141OSB_EVKIT	1	MAX86141 EVSYS Sensor PCB
150150225	1	Molex, Flex Cable, 25 Pins
CY5677	1	Cypress, BLE Dongle
101181XX-000XXX	1	USB-C to USB-A Cable, 3 Ft.

MAX86140/MAX86141
Evaluation System

Evaluates: MAX86140 and MAX86141

MAX86140/MAX86141 EV Kit Bill of Materials

MAXSENSORBLEEK#

ITEM	REF_DES	DNI/DNP	QTY	MFG PART #	MANUFACTURER	VALUE	DESCRIPTION	COMMENTS
1	A1	-	1	2450AT18A100	JOHANSON TECHNOLOGY	2450AT18A100	ANTENNA; 2450AT SERIES; BOARDMOUNT; MINI 2.45 GHZ ANTENNA; 2450MHZ	
2	BAT	-	1	B2B-PH-K-S(LF)(SN)	JST MANUFACTURING	B2B-PH-K-S(LF)(SN)	CONNECTOR; MALE; THROUGH HOLE; PH CONNECTOR; 2MM PITCH; SHROUDED HEADER; STRAIGHT; 2PINS	
3	C1, C22, C26, C30-C37	-	11	GRM033R61A104KE15; LMK063BJ104KP	MURATA;TAIYO YUDEN	0.1UF	CAPACITOR; SMT (0201); CERAMIC CHIP; 0.1UF; 10V; TOL=10%; MODEL=; TG=-55 DEGC TO +125 DEGC; TC=X5R	
4	C2, C15, C25, C38-C43	-	9	GRM033R61A105ME15	MURATA	1UF	CAPACITOR; SMT (0201); CERAMIC CHIP; 1UF; 10V; TOL=20%; TG= -55 DEGC TO +85 DEGC; TC=X5R	
5	C3, C4, C8, C9, C12, C16, C27	-	7	C1005X5R1A475M050BC	TDK	4.7UF	CAPACITOR; SMT (0402); CERAMIC CHIP; 4.7UF; 10V; TOL=20%; MODEL=C SERIES; TG=-55 DEGC TO +85 DEGC; TC=X5R	
6	C5-C7, C10, C13, C14, C47	-	7	GRM155R60J226ME11	MURATA	22UF	CAPACITOR; SMT (0402); CERAMIC CHIP; 22UF; 6.3V; TOL=20%; TC=X5R	
7	C19	-	1	GJM0335C1E1R0WB01	MURATA	1PF	CAPACITOR; SMT (0201); CERAMIC CHIP; 1PF; 25V; TOL=0.05PF; TG=-55 DEGC TO +125 DEGC; TC=C0G	
8	C20, C21, C28, C29, C45, C46, Z44	-	7	GRM0335C1H120GA01	MURATA	12PF	CAPACITOR; SMT (0201); CERAMIC CHIP; 12PF; 50V; TOL=2%; TG=-55 DEGC TO +125 DEGC; TC=C0G	
9	C23, C24	-	2	GRM0335C1H101JA01	MURATA	100PF	CAPACITOR; SMT (0201); CERAMIC CHIP; 100PF; 50V; TOL=5%; TG=-55 DEGC TO +125 DEGC; TC=C0G	
10	CN1	-	1	DX07S024JJ3	JAE ELECTRONIC INDUSTRY	DX07S024JJ3	CONNECTOR; FEMALE; SMT; USB TYPE-C CONNECTOR; DX07 SERIES RECEPTACLE; RIGHT ANGLE; 24PINS	
11	DS1, DS2	-	2	SML-P11UTT86	ROHM	SML-P11UTT86	DIODE; LED; SMT; PIV=1.8V; IF=0.02A	
12	J3	-	1	5035662500	MOLEX	5035662500	CONNECTOR; FEMALE; SMT; EASY-ON TYPE HOUSING ASSEMBLY; RIGHT ANGLE; 25PINS	
13	L1, L2	-	2	DFM18PAN2R2MGOL	MURATA	2.2UH	INDUCTOR; SMT (0603); CERAMIC CHIP; 2.2UH; TOL=+/-20%; 1.1A;	
14	L3	-	1	DFE201610E-4R7M=P2	MURATA	4.7UH	INDUCTOR; SMT (2016); METAL ALLOY CHIP; 4.7UH; TOL=+/-20%; 1.3A	
15	L4	-	1	LQP03HQ3N3B02	MURATA	3.3NH	INDUCTOR; SMT (0201); FILM TYPE; 3.3NH; TOL=+/-0.1nH; 0.5A	
16	LED	-	1	SML-LX0404SIUPGUSB	LUMEX OPTOCOMPONENTS INC	SML-LX0404SIUPGUSB	DIODE; LED; SML; FULL COLOR; WATER CLEAR LENS; RED-GREEN-BLUE; SMT; VF=2.95V; IF=0.1A	
17	R2, R3, R11, R15, R24, R27-R31, R34	-	11	ERJ-2GEOR00X	PANASONIC	0	RESISTOR; 0402; 0 OHM; 0%; JUMPER; 0.10W; THICK FILM	
18	R5, R9	-	2	ERJ-1GEF1002C	PANASONIC	10K	RESISTOR; 0201; 10K OHM; 1%; 200PPM; 0.05W; THICK FILM	
19	R6, R7, R16, R17, R23, R25, R26	-	7	ERJ-1GEF4701C	PANASONIC	4.7K	RESISTOR; 0201; 4.7K OHM; 1%; 100PPM; 0.05W; THICK FILM 3-LAYER ELECTRODE	
20	R8	-	1	ERJ-1GEF3902C	PANASONIC	39K	RESISTOR; 0201; 39K OHM; 1%; 100PPM; 0.05W; THICK FILM 3-LAYER ELECTRODE	

MAX86140/MAX86141
Evaluation System

Evaluates: MAX86140 and MAX86141

MAX86140/MAX86141 EV Kit Bill of Materials (continued)

MAXSENSORBLEEK#

ITEM	REF_DES	DNI/DNP	QTY	MFG PART #	MANUFACTURER	VALUE	DESCRIPTION	COMMENTS
21	R10	-	1	NCP15XH103F03RC	MURATA	10K	THERMISTOR; SMT (0402); THICK FILM (NICKEL PLATED); 10K; TOL=+/-1%	
22	R13	-	1	ERJ-1GEF2613C	PANASONIC	261K	RESISTOR; 0201; 261K OHM; 1%; 200PPM; 0.05W; THICK FILM	
23	R14	-	1	CRCW0201100KFK	VISHAY DALE	100K	RESISTOR; 0201; 100K OHM; 1%; 100PPM; 0.05W; THICK FILM	
24	R18, R19	-	2	ERJ-1GEF2000C	PANASONIC	200	RESISTOR; 0201; 200 OHM; 1%; 200PPM; 0.05W; THICK FILM	
25	RA1-RA4	-	4	ERJ-1GEF33R0C	PANASONIC	33	RESISTOR; 0201; 33 OHM; 1%; 100PPM; 0.05W; THICK FILM 3-LAYER ELECTRODE	
26	SW	-	1	EVP-AWCD2A	PANASONIC	EVP-AWCD2A	SWITCH; SPST; SMT; STRAIGHT; 15V; 0.02A; EVP-AW SERIES	
27	U1	-	1	MAX20303	MAXIM	MAXIM SENSOR PLATFORM 2	EVKIT PART- IC; WEARABLE POWER MANAGEMENT SOLUTION; PACKAGE OUTLINE; WLP 56 PINS; 0.5MM PITCH; PKG. CODE: W563A4+1; PKG. OUTLINE: 21-100104;	
28	U2	-	1	NRF52832-CIAA	NORDIC SEMICONDUCTOR	NRF52832-CIAA	IC; SOC; MULTIPROTOCOL BLUETOOTH LOW ENERGY; ANT; 2.4GHZ RF SOC; WLCSP50	
29	U3-U6, U9	-	5	MAX14689EWL+	MAXIM	MAX14689EWL+	IC; ASW; 0.125A; FREQUENCY-SELECTSBLE; SWITCHED-CAPACITOR VOLTAGE CONVERTER; WLP9 1.2X1.2	
30	U7	-	1	IP4221CZ6-S	NXP	IP4221CZ6-S	IC; PROT; ESD PROTECTION FOR HIGH-SPEED INTERFACE; XSON6	
31	U8	-	1	S25F5256SAGNF001	SPANSION	S25F5256SAGNF001	IC; MMRY; MIRRORBIT FLASH; NON-VOLATILE MEMORY; 1.8V SINGLE SUPPLY WITH CMOS I/O; SERIAL PERIPHERAL INTERFACE WITH MULTI-I/O; WSON8-EP	
32	U10, U11	-	2	MAX9062EBS+G45	MAXIM	MAX9062EBS+G45	IC; COMP; ULTRA-SMALL; LOW-POWER SINGLE COMPARATOR; UCSP4	
33	U12	-	1	MAX32620IWG+	MAXIM	MAX32620IWG+	IC; UCON; HIGH-PERFORMANCE; ULTRA-LOW POWER CORTEX-M4F MICROCONTROLLER FOR RECHARGEABLE DEVICES; WLP81	
34	U13	-	1	74AUP1G97GF	NXP	74AUP1G97GF	IC; LOGC; LOW-POWER CONFIGURABLE MULTIPLE FUNCTION GATE; XSON6	
35	U29	-	1	MAX1819EBL50+	MAXIM	MAX1819EBL50+	IC; VREG; 500MA LOW-DROPOUT LINEAR REGULATOR IN UCSP; UCSP6	
36	X2, Y2	-	2	ECS-.327-6-12	ECS INC	32.768KHZ	CRYSTAL; SMT 2.0 MM X 1.2 MM; 6PF; 32.768KHZ; +/-20PPM; -0.03PPM/DEGC2	
37	Y1	-	1	US3200005Z	PERICOM SEMICONDUCTOR	32MHZ	CRYSTAL; SMT 1.6 MM X 1.2MM; 8PF; 32MHZ; +/-10PPM; +/-10PPM	
38	PCB	-	1	MAXSENSORBLE	MAXIM	PCB	PCB:MAXSENSORBLE	-
39	MISC1	DNI	1	101181XX-000XXX	N/A	101181XX-000XXX	CONNECTOR; MALE; PALETTE SERIES 3.0 USB-C TO USB-A; 3FT BLACK	
40	R1, R4, R12, R20-R22, R32, R33	DNP	0	ERJ-2GEOR00X	PANASONIC	0	RESISTOR; 0402; 0 OHM; 0%; JUMPER; 0.10W; THICK FILM	
41	Z17	DNP	0	GJM0335C1E1ROWB01	MURATA	1PF	CAPACITOR; SMT (0201); CERAMIC CHIP; 1PF; 25V; TOL=0.05PF; TG=-55 DEGC TO +125 DEGC; TC=COG	
42	Z18	DNP	0	250R05L1R8AV4	JOHANSON TECHNOLOGY	1.8PF	CAPACITOR; SMT (0201); MICROWAVE; 1.8PF; 25V; TOL=0.05PF; TG=-55 DEGC TO +125 DEGC; TC=COG	
43	Jan-36	DNP	0	N/A	N/A	N/A	TEST POINT; PAD DIA=0.762MM; BOARD HOLE=0.381MM	
TOTAL			105					

MAX86140/MAX86141
Evaluation System

Evaluates: MAX86140 and MAX86141

MAX86140/MAX86141 EV Kit Bill of Materials (continued)

MAX86140OSBEK#

ITEM	REF_DES	DNI/DNP	QTY	MFG PART #	MANUFACTURER	VALUE	DESCRIPTION	COMMENTS
1	C1-C3, C5, C6, C9	-	6	GRM155R60J226ME11	MURATA	22UF	CAPACITOR; SMT (0402); CERAMIC CHIP; 22UF; 6.3V; TOL=20%; TC=X5R	
2	C4, C8	-	2	GRM033R61A105ME15	MURATA	1UF	CAPACITOR; SMT (0201); CERAMIC CHIP; 1UF; 10V; TOL=20%; TG=-55 DEGC TO +85 DEGC; TC=X5R	
3	C7	-	1	GRM155R61A106ME44; GRM155R61A106ME11; 0402ZD106MAT2A	MURATA;MURATA;AVX	10UF	CAPACITOR; SMT (0402); CERAMIC CHIP; 10UF; 10V; TOL=20%; TG=-55 DEGC TO +85 DEGC; TC=X5R	
4	D1	-	1	VEMD5080X01	VISHAY SEMICONDUCTORS	VEMD5080X01	DIODE; PIN; SMT; VRM=20V; IR=0.000045A	
5	DS1, DS2	-	2	CT DBLP31.12-5C8C-56-J6Q6	OSRAM	CT DBLP31.12-5C8C-56-J6Q6	DIODE; LED; GREEN; SMT; VF=2.3V; IF=0.02A;	
6	J1	-	1	5016162575	MOLEX	5016162575	CONNECTOR; FEMALE; SMT; EASY-ON TYPE FPC CONNECTOR; RIGHT ANGLE; 25PINS	
7	R1-R3, R4A-R8A, R9-R12	-	12	CRCW02010000ZS;ERJ-1GN0R00C	VISHAY DALE;PANASONIC	0	RESISTOR; 0201; 0 OHM; 0%; JUMPER; 0.05W; THICK FILM	
8	U1	-	1	MAX86140	MAXIM	MAX86140	EVKIT PART-IC; OPTICAL AFE OPTIMIZE FOR HR ON WRIST APPLICATION; WLP20	
9	U2	-	1	BMA280	BOSCH	BMA280	IC; SNSR; 14 BIT DIGITAL TRIAXIAL ACCELERATION SENSOR WITH INTELLIGENT ON-CHIP MOTION-TRIGGERED INTERRUPT CONTROLLER; LGA12	
10	PCB	-	1	MAX86140OSB	MAXIM	PCB	PCB:MAX86140OSB	-
11	R4B-R8B	DNP	0	CRCW02010000ZS;ERJ-1GN0R00C	VISHAY DALE;PANASONIC	0	RESISTOR; 0201; 0 OHM; 0%; JUMPER; 0.05W; THICK FILM	
TOTAL			28					

MAX86141OSBEK#

ITEM	REF_DES	DNI/DNP	QTY	MFG PART #	MANUFACTURER	VALUE	DESCRIPTION	COMMENTS
1	C1-C5, C10	-	6	GRM155R60J226ME11	MURATA	22UF	CAPACITOR; SMT (0402); CERAMIC CHIP; 22UF; 6.3V; TOL=20%; TC=X5R	
2	C7	-	1	GRM155R61A106ME44; GRM155R61A106ME11; 0402ZD106MAT2A	MURATA;MURATA;AVX	10UF	CAPACITOR; SMT (0402); CERAMIC CHIP; 10UF; 10V; TOL=20%; TG=-55 DEGC TO +85 DEGC; TC=X5R	
3	C8, C9	-	2	GRM033R61A105ME15	MURATA	1UF	CAPACITOR; SMT (0201); CERAMIC CHIP; 1UF; 10V; TOL=20%; TG=-55 DEGC TO +85 DEGC; TC=X5R	
4	DS1	-	1	CT DBLP31.12-5C8C-56-J6Q6	OSRAM	CT DBLP31.12-5C8C-56-J6Q6	DIODE; LED; GREEN; SMT; VF=2.3V; IF=0.02A;	
5	J1	-	1	5016162575	MOLEX	5016162575	CONNECTOR; FEMALE; SMT; EASY-ON TYPE FPC CONNECTOR; RIGHT ANGLE; 25PINS	
6	PD1, PD2	-	2	VEMD5080X01	VISHAY SEMICONDUCTORS	VEMD5080X01	DIODE; PIN; SMT; VRM=20V; IR=0.000045A	
7	R1-R3, R4A-R8A, R9-R12	-	12	CRCW02010000ZS;ERJ-1GN0R00C	VISHAY DALE;PANASONIC	0	RESISTOR; 0201; 0 OHM; 0%; JUMPER; 0.05W; THICK FILM	
8	U1	-	1	MAX86141	MAXIM	MAX86141	EVKIT PART-IC; OPTICAL ANALOG FRONT-END (AFE) OPTIMIZE FOR HR ON WRIST APPLICATION; WLP20	
9	U2	-	1	BMA280	BOSCH	BMA280	IC; SNSR; 14 BIT DIGITAL TRIAXIAL ACCELERATION SENSOR WITH INTELLIGENT ON-CHIP MOTION-TRIGGERED INTERRUPT CONTROLLER; LGA12	
10	PCB	-	1	MAX86141OSB	MAXIM	PCB	PCB:MAX86141OSB	-
11	R4B-R8B	DNP	0	CRCW02010000ZS;ERJ-1GN0R00C	VISHAY DALE;PANASONIC	0	RESISTOR; 0201; 0 OHM; 0%; JUMPER; 0.05W; THICK FILM	
TOTAL			28					

MAX86140/MAX86141 EV Kit Schematics

MAXSensorBLE

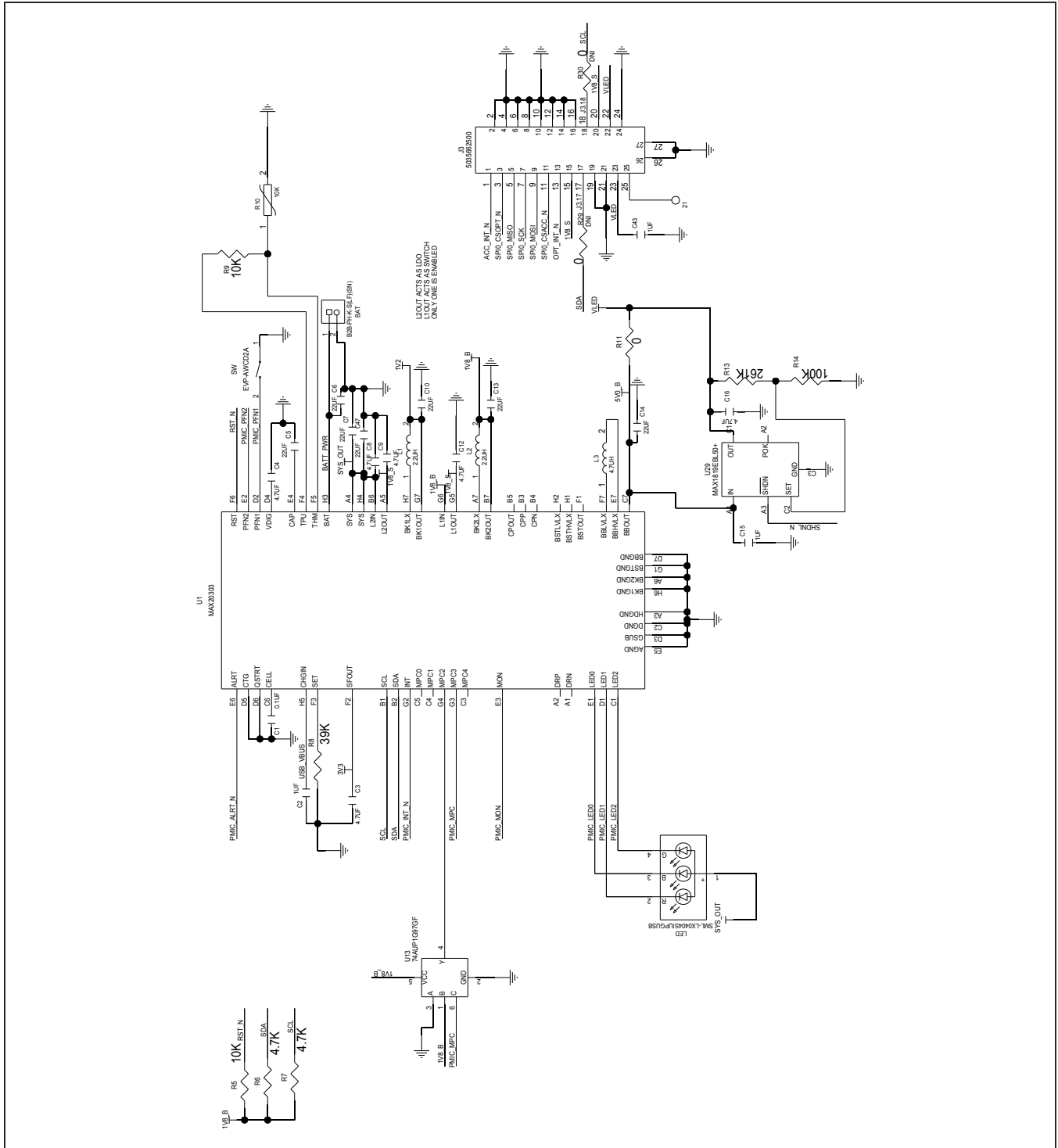

MAX86140/MAX86141 Evaluation System

Evaluates: MAX86140 and MAX86141

MAX86140/MAX86141 EV Kit Schematics (continued)

MAXSensorBLE

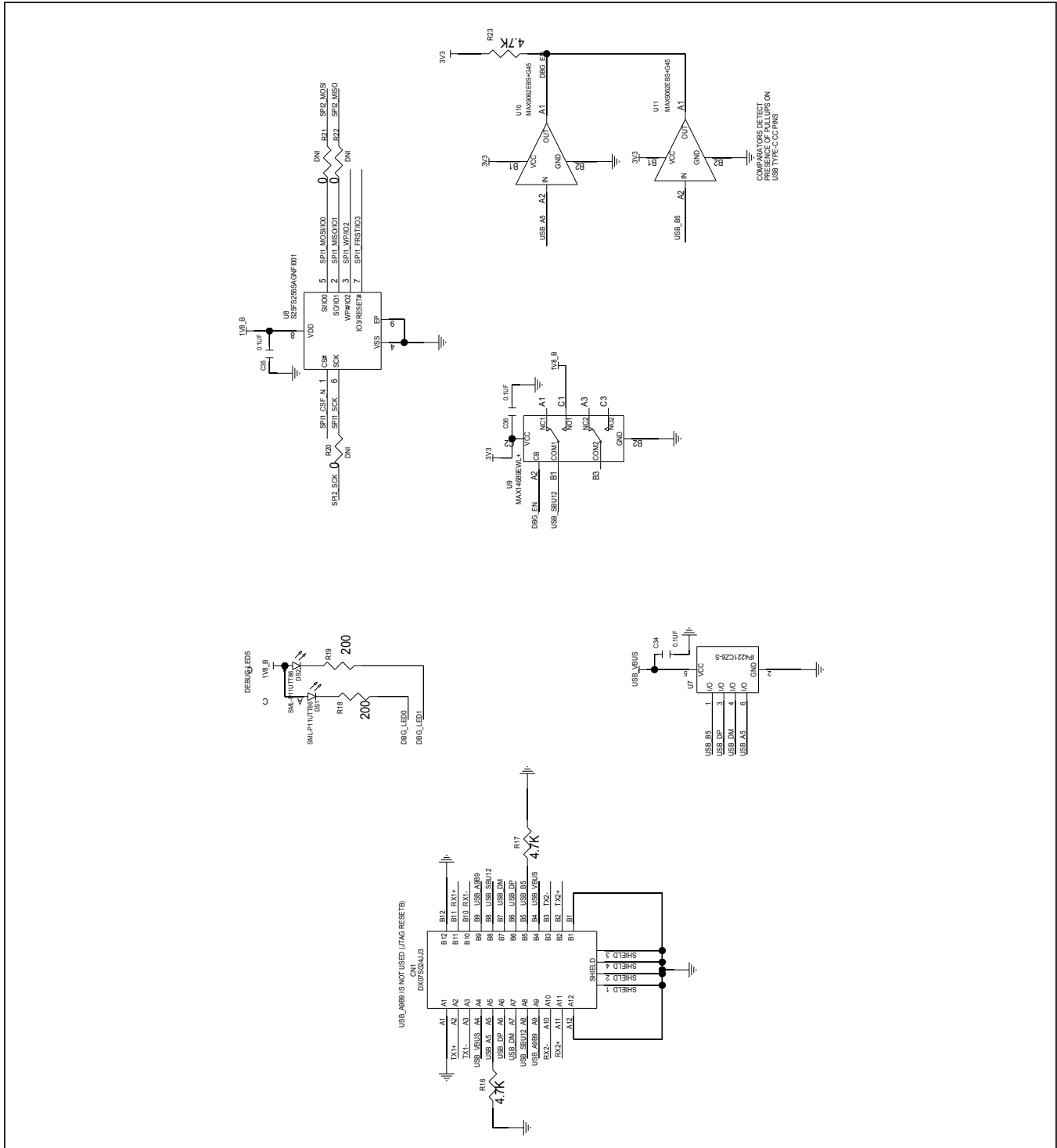

MAX86140/MAX86141 Evaluation System

Evaluates: MAX86140 and MAX86141

MAX86140/MAX86141 EV Kit Schematics (continued)

MAXSensorBLE

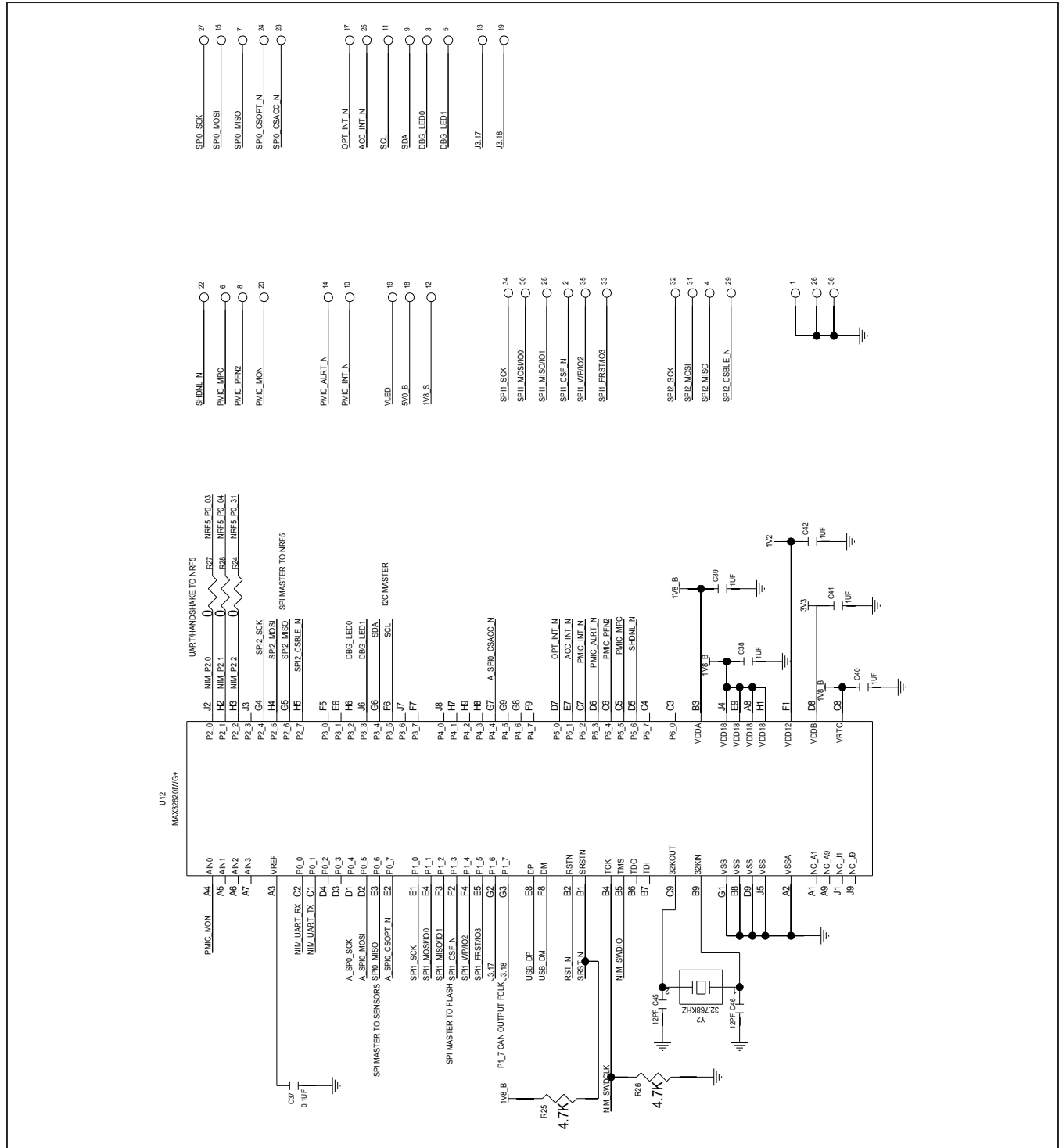

MAX86140/MAX86141 EV Kit Schematics (continued)

MAX86140_OS_B_EVKIT

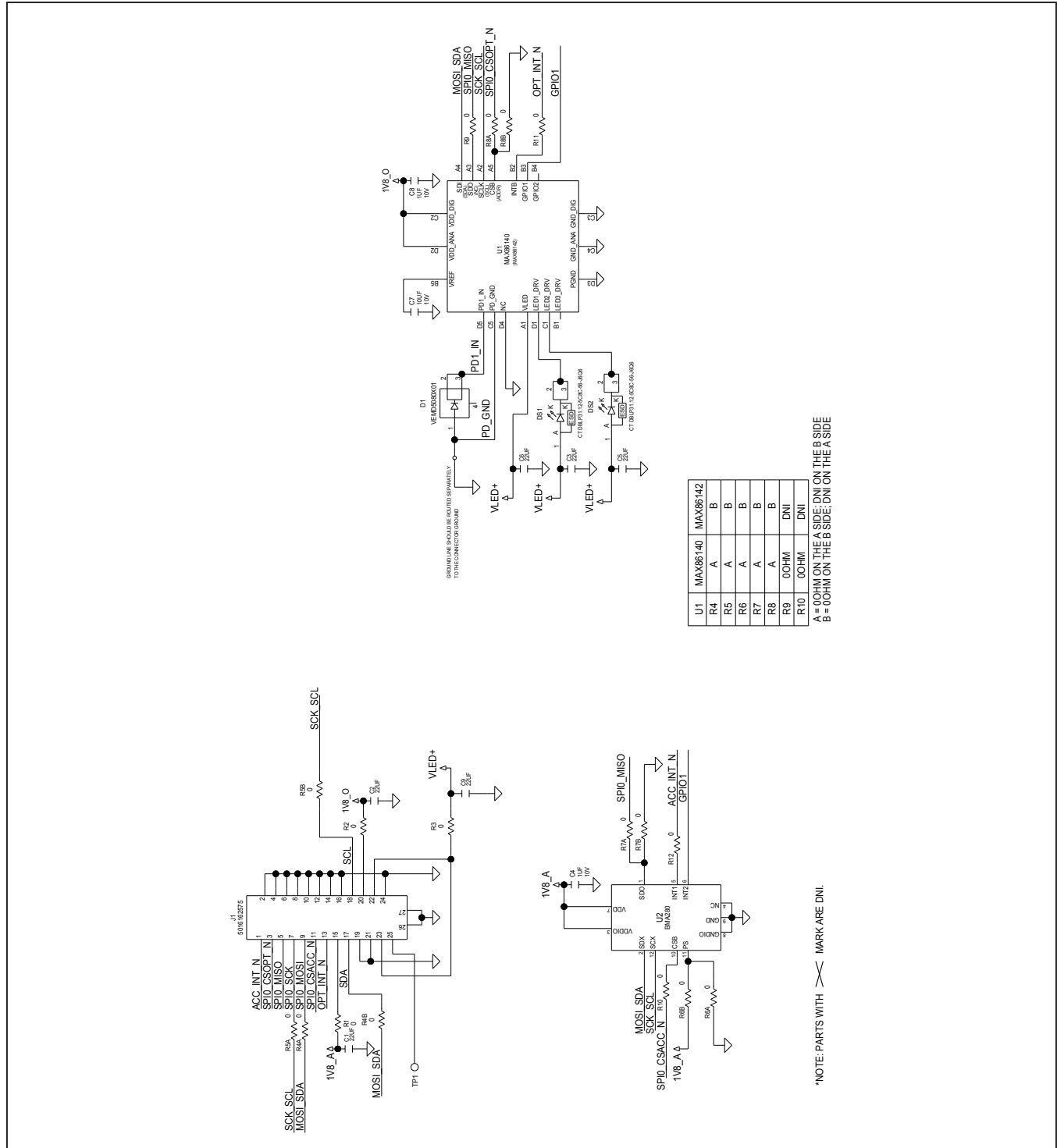

MAX86140/MAX86141 EV Kit Schematics (continued)

MAX86141_OS_B_EVKIT

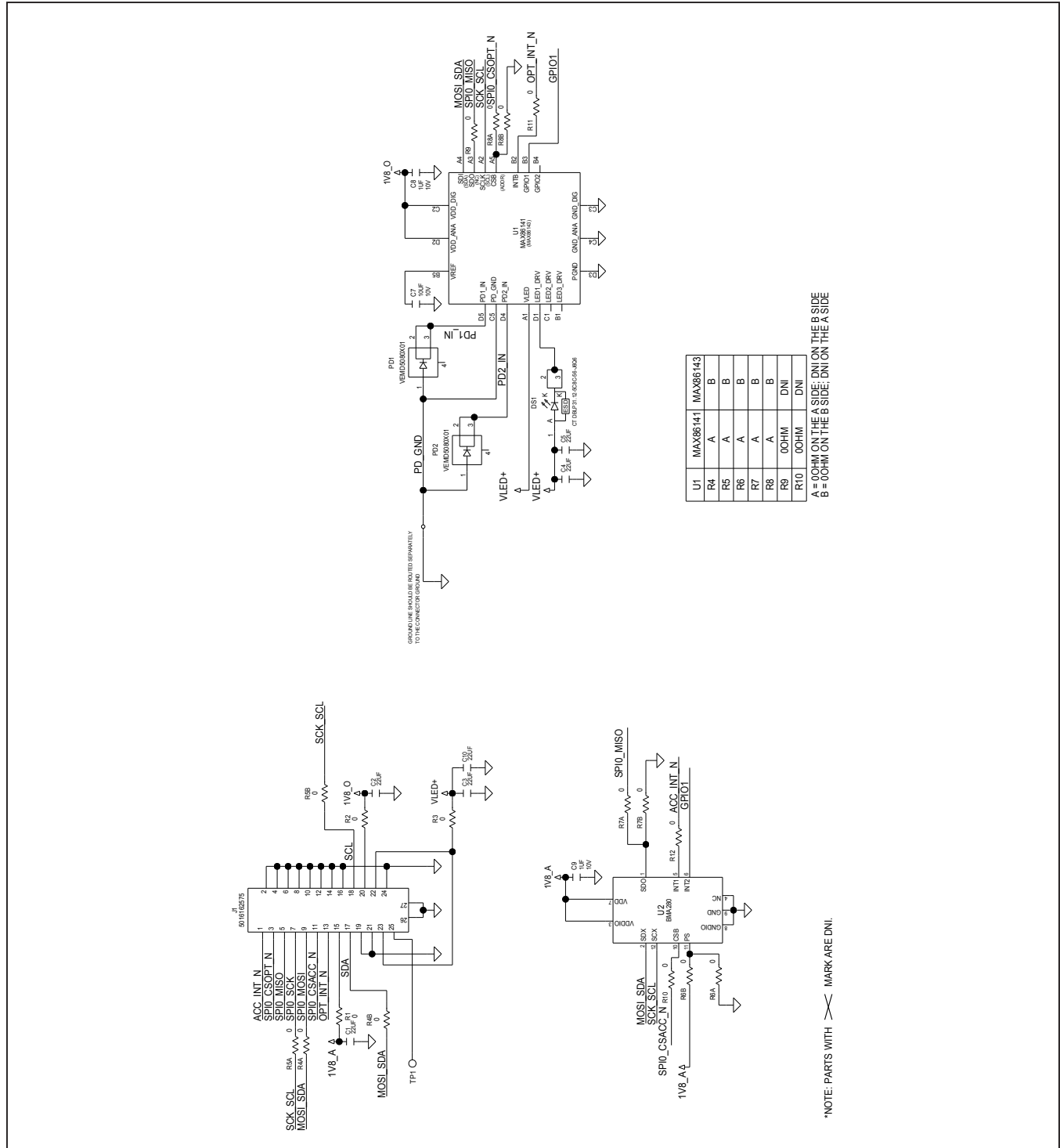

MAX86140/MAX86141
Evaluation System

Evaluates: MAX86140 and MAX86141

MAX86140/MAX86141 EV Kit PCB Layout Diagrams

MAXSensorBLE_EVKIT

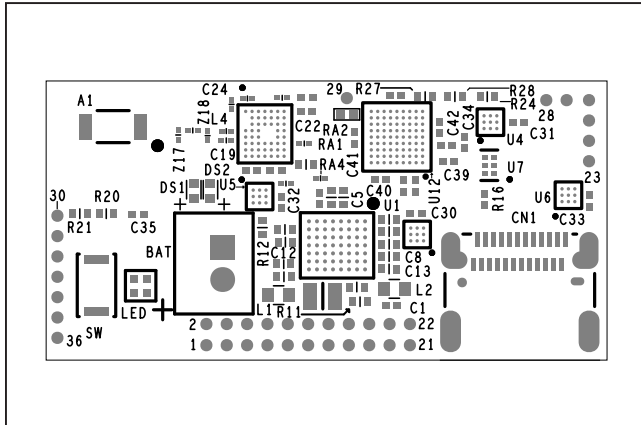

MAXSensorBLE_EVKIT—Silk_Top

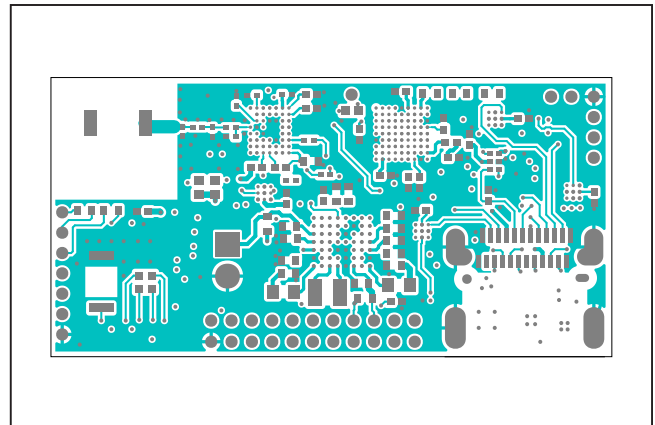

MAXSensorBLE_EVKIT—Top

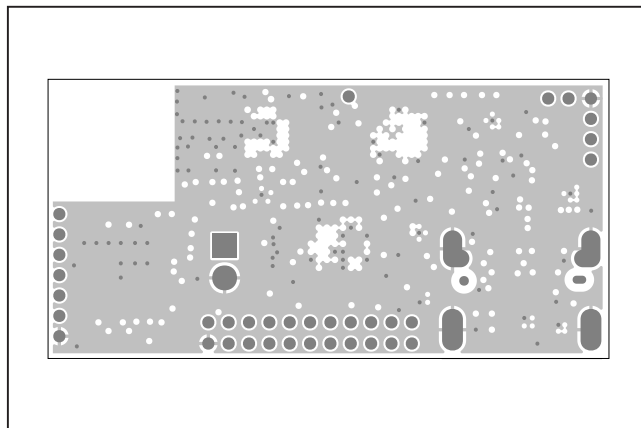

MAXSensorBLE_EVKIT—L02_GND

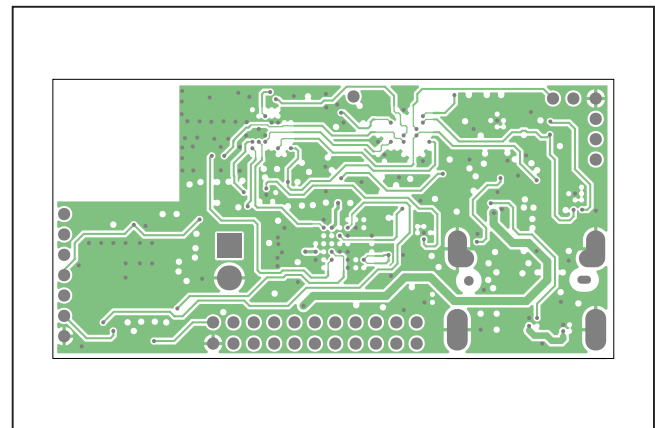

MAXSensorBLE_EVKIT—L03_SIGS

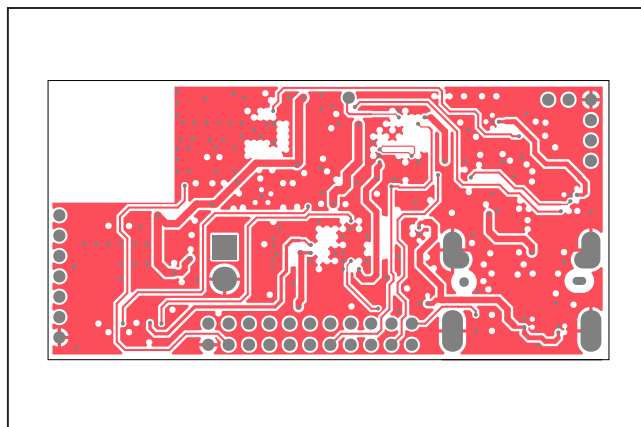

MAXSensorBLE_EVKIT—L04_SIGS

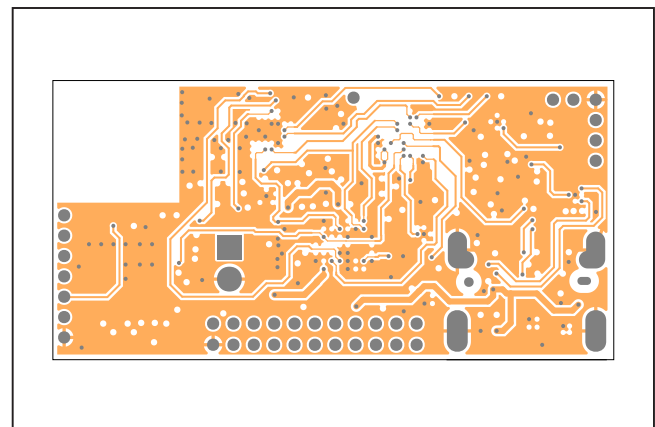

MAXSensorBLE_EVKIT—L05_SIGS

MAX86140/MAX86141 EV Kit PCB Layout Diagrams (continued)

MAXSensorBLE_EVKIT

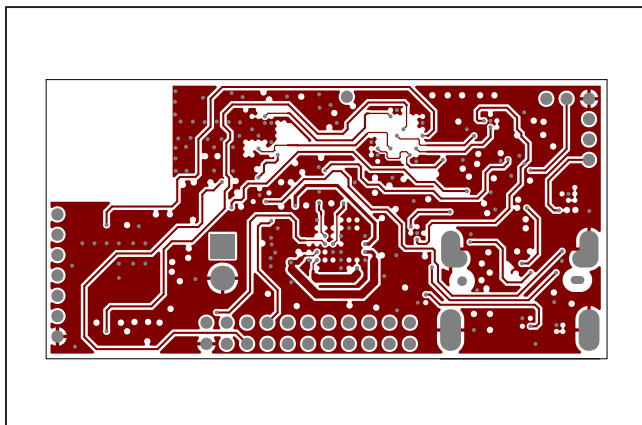

MAXSensorBLE_EVKIT—L06_SIGS

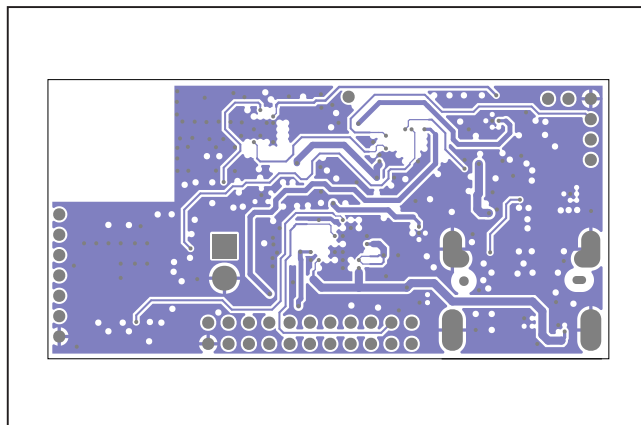

MAXSensorBLE_EVKIT—L07_SIGS

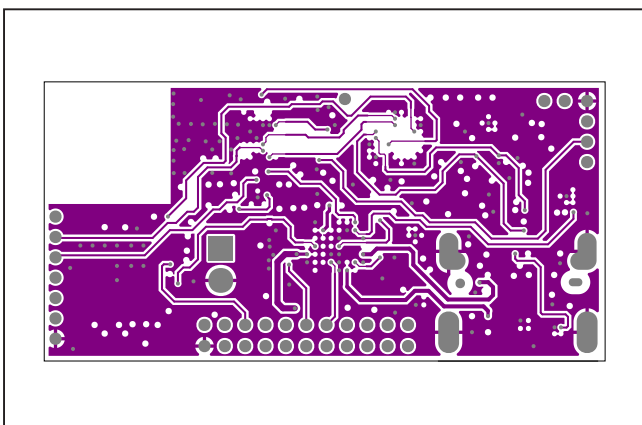

MAXSensorBLE_EVKIT—L08_SIGS

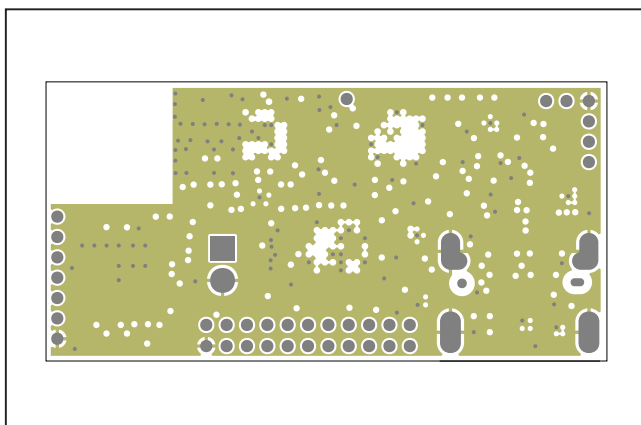

MAXSensorBLE_EVKIT—L09_GND

MAX86140/MAX86141 EV Kit PCB Layout Diagrams (continued)

MAX86140_OSBEVKIT

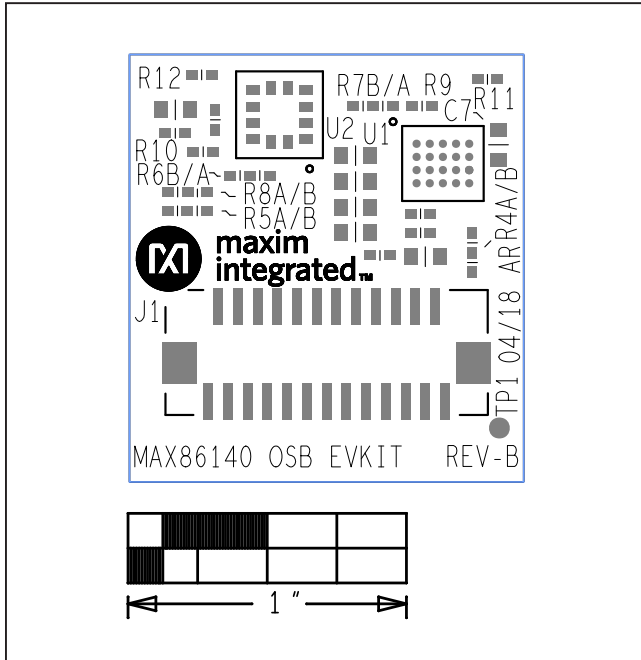

MAX86140OSBEK#—SILK_TOP

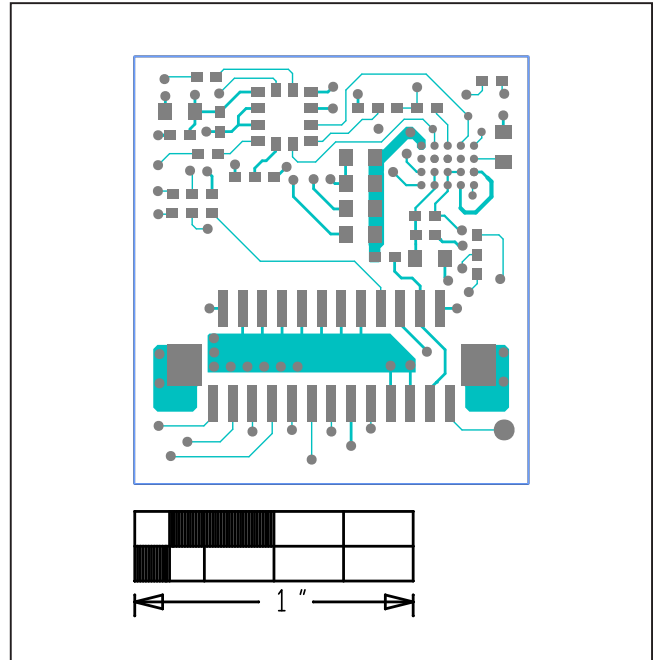

MAX86140OSBEK#—Top

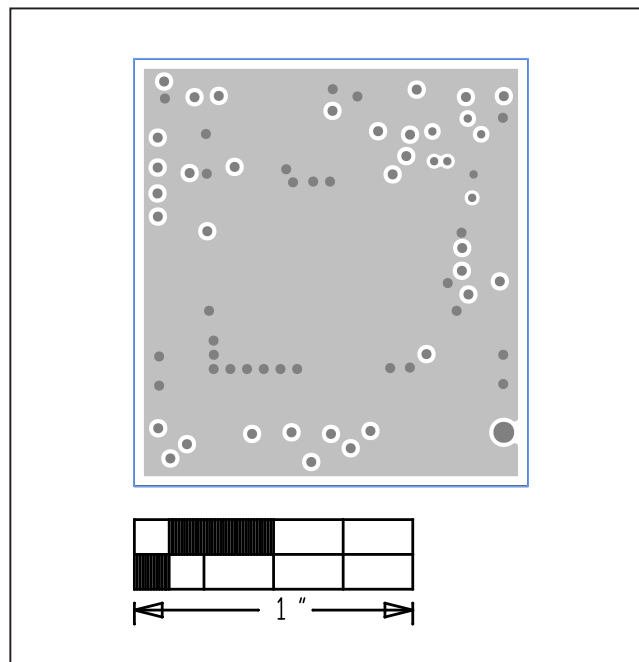

MAX86140OSBEK#—L02_GND

MAX86140/MAX86141 EV Kit PCB Layout Diagrams (continued)

MAX86140_OSB_EVKIT

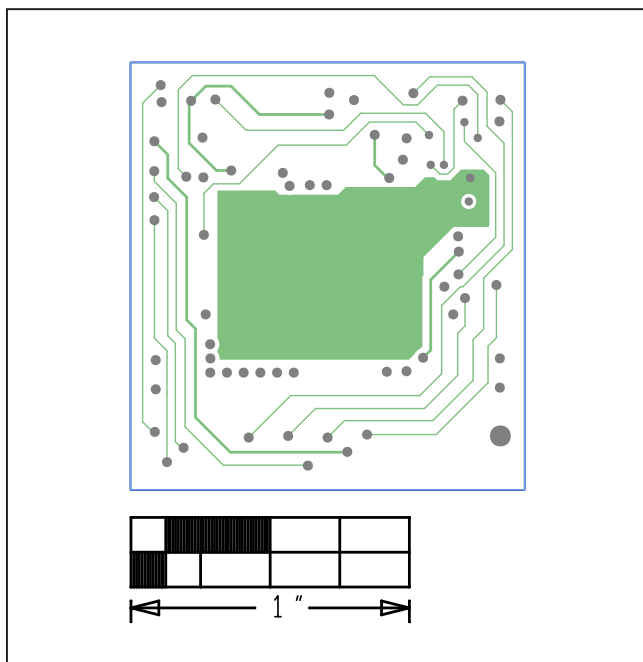

MAX86140OSBEK#—L03_SIG

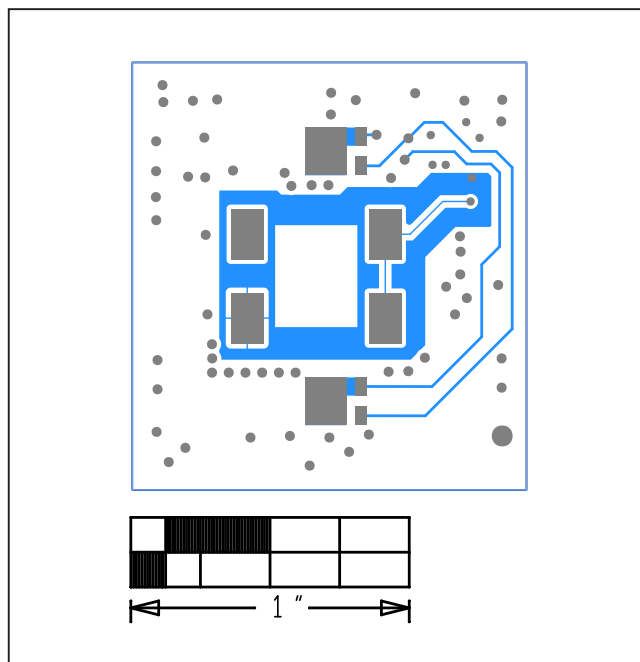

MAX86140OSBEK#—BOTTOM

MAX86140/MAX86141 EV Kit PCB Layout Diagrams (continued)

MAX86141_OSB_EVKIT

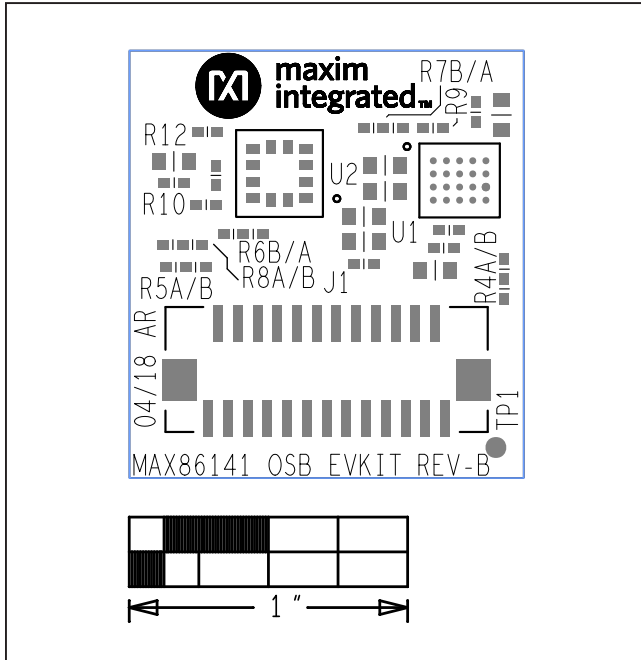

MAX86141OSBEK#—Silk_Top

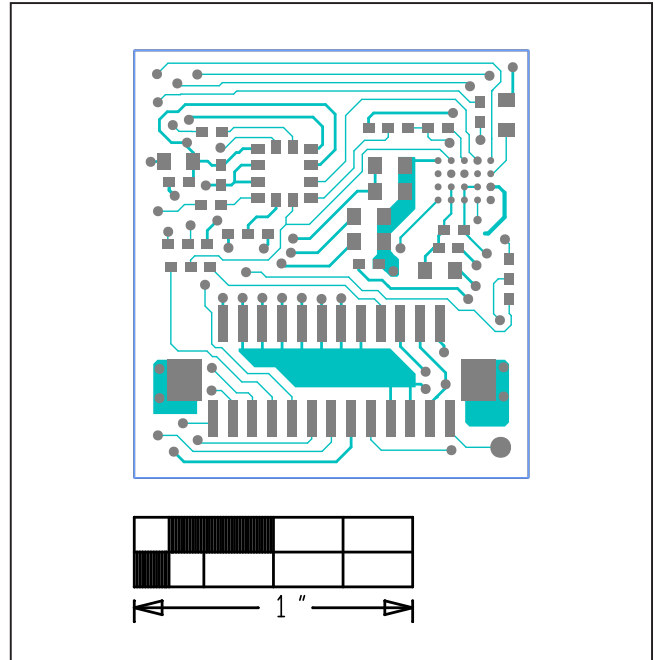

MAX86141OSBEK#—Top

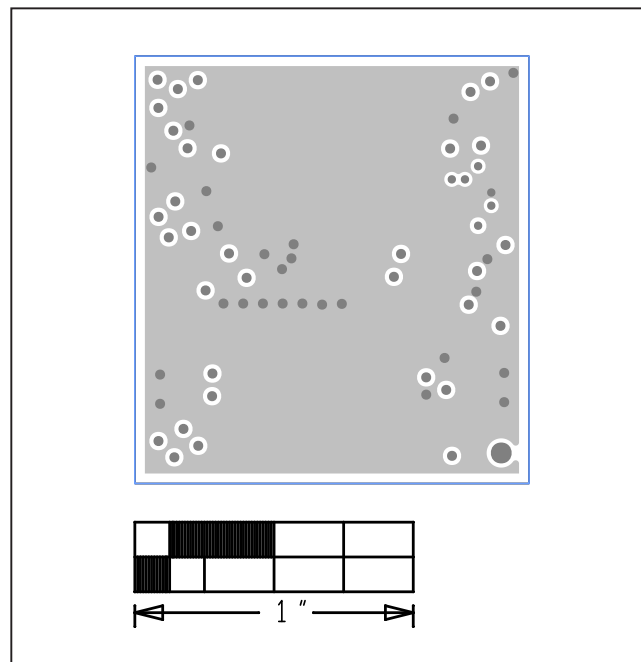

MAX86141OSBEK#—L02_GND

MAX86140/MAX86141 EV Kit PCB Layout Diagrams (continued)

MAX86141_OSBEVKIT

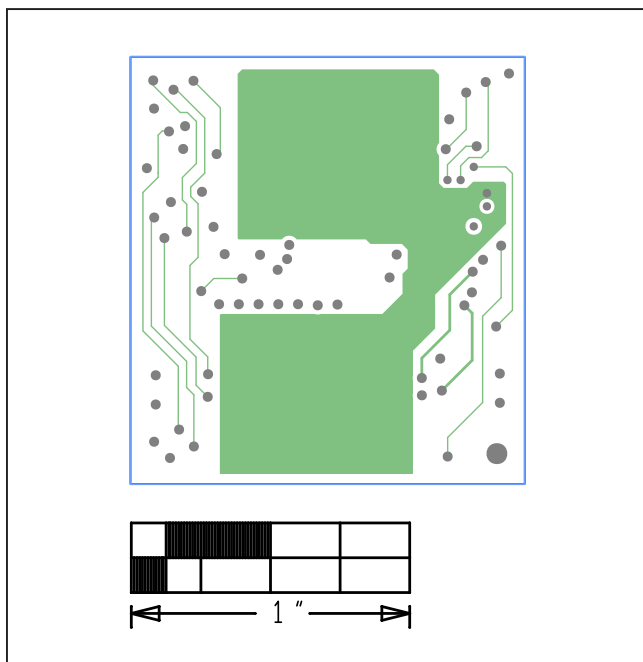

MAX86141OSBEK#—L03_SIG

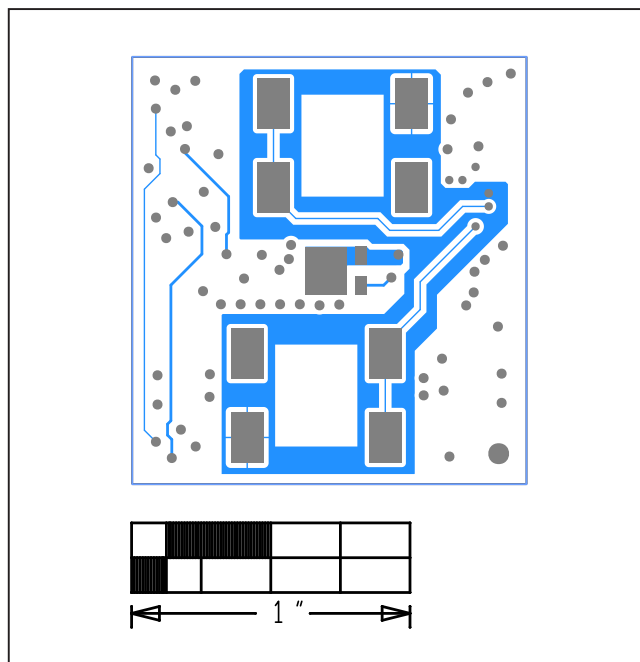

MAX86141OSBEK#—L04_SIG

Revision History

REVISION NUMBER	REVISION DATE	DESCRIPTION	PAGES CHANGED
0	8/17	Initial release	—
1	10/18	Updated the <i>General Description</i> , <i>Quick Start</i> , and <i>Detailed Description of Software</i> sections; replaced Figures 9–12, <i>Component List</i> , <i>Bill of Materials</i> , <i>Schematics</i> , and <i>PCB Layout</i>	1, 9–11, 15, 19, 20–35

For pricing, delivery, and ordering information, please visit Maxim Integrated's online storefront at <https://www.maximintegrated.com/en/storefront/storefront.html>.

Maxim Integrated cannot assume responsibility for use of any circuitry other than circuitry entirely embodied in a Maxim Integrated product. No circuit patent licenses are implied. Maxim Integrated reserves the right to change the circuitry and specifications without notice at any time.

X-ON Electronics

Largest Supplier of Electrical and Electronic Components

Click to view similar products for [Multiple Function Sensor Development Tools](#) category:

Click to view products by [Maxim](#) manufacturer:

Other Similar products are found below :

[MAXWSNENV#](#) [STEVAL-MKIT01V1](#) [KT-O2-25%-TB200A-E](#) [KT-TVOC-200-TB200A](#) [KT-NmHc-200-TB200A](#) [SEN0344](#) [PIM520](#)
[PIM518](#) [PIM519](#) [PIM502](#) [EVAL-AD7746HDZ](#) [AS7022-EVALKIT](#) [ALTEHTG2SMIP](#) [OB1203SD-U-EVK](#) [MIKROE-4265](#) [ARG-LDKT](#)
[EV_ICG-20660L](#) [GX-F12A-P](#) [GX-F15A](#) [GX-F6A-P](#) [GX-F8B](#) [GX-H12A-P](#) [GX-H15AI-P](#) [GX-H6A-P](#) [1093](#) [MIKROE-2455](#) [MIKROE-2458](#)
[MIKROE-2507](#) [MIKROE-2508](#) [MIKROE-2516](#) [MIKROE-2529](#) [1458](#) [MIKROE-1628](#) [176](#) [189](#) [1893](#) [2106](#) [ATQT4-XPRO](#) [GP30-DEMO](#)
[MODULE](#) [GX-F12AI-P](#) [GX-F15A-P](#) [GX-F8A-P](#) [GX-FL15B-P](#) [GX-H15A-P](#) [GX-H6AI-P](#) [GX-H8A](#) [GX-H8AI-P](#) [GX-H8A-P](#) [GX-F15AI-P](#)
[GX-FL15A-P](#)