



## Low-Dropout, 120mA Linear Regulators

### General Description

The MAX8873T/S/R and MAX8874T/S/R low-dropout linear regulators operate from a +2.5V to +6.5V input range and deliver up to 120mA. A PMOS pass transistor allows the low, 82µA supply current to remain independent of load, making these devices ideal for battery-operated portable equipment such as cellular phones and cordless phones.

The devices feature Dual Mode™ operation: their output voltage is preset (at 3.15V for the T versions, 2.84V for the S versions, or 2.80V for the R versions) or can be adjusted with an external resistor divider. Total error on the output is ±3.5%. Output voltages are set on the low side of popular ranges so that power drain is minimized for longer battery life. Other features include low-power shutdown, short-circuit protection, thermal shutdown protection, and reverse battery protection. The MAX8874 also includes an auto-discharge function, which actively discharges the output voltage to ground when the device is placed in shutdown mode. Both devices come in a miniature 5-pin SOT23 package.

For dual versions, refer to the MAX8865/MAX8866 data sheet. For low-noise versions with 30µVRMS output noise, refer to the MAX8877/MAX8878.

### Applications

Cordless Telephones	Modems
PCS Telephones	Hand-Held Instruments
Cellular Telephones	Palmtop Computers
PCMCIA Cards	Electronic Planners

### Typical Operating Circuit

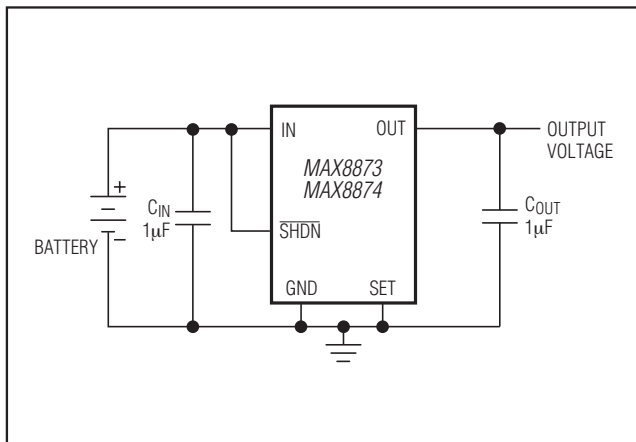

Dual Mode is a trademark of Maxim Integrated Products.

### Features

- ◆ LP2980 Pin-Compatible SOT23 Package
- ◆ Low, 55mV Dropout Voltage at 50mA I<sub>OUT</sub> (130mV at 120mA)
- ◆ Low, 73µA No-Load Supply Current  
Low, 82µA Operating Supply Current (even in dropout)
- ◆ Miniature External Components
- ◆ Thermal Overload Protection
- ◆ Output Current Limit
- ◆ Reverse Battery Protection
- ◆ Dual Mode Operation: Fixed or Adjustable (1.25V to 6.5V) Output
- ◆ Low-Power Shutdown

### Ordering Information

PART	TEMP RANGE	PIN-PACKAGE	SOT TOP MARK
MAX8873TEUK+T	-40°C to +85°C	5 SOT23	ABZH
MAX8873SEUK+T	-40°C to +85°C	5 SOT25	ABZI
MAX8873REUK+T	-40°C to +85°C	5 SOT23	ABZL
MAX8873REUK/V+T	-40°C to +85°C	5 SOT23	AFMM
MAX8874TEUK+T	-40°C to +85°C	5 SOT23	ABZJ
MAX8874SEUK+T	-40°C to +85°C	5 SOT23	ABZK
MAX8874REUK+T	-40°C to +85°C	5 SOT23	ABZM

+Denotes a lead-free (Pb)/RoHS-compliant package.  
V denotes an automotive qualified part.

### Pin Configuration

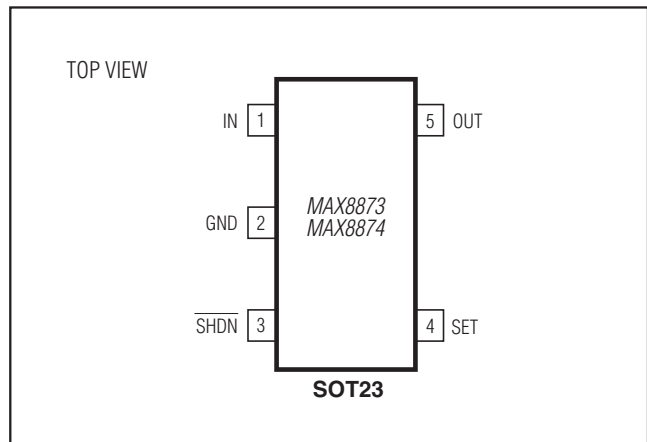

# MAX8873T/S/R, MAX8874T/S/R

## Low-Dropout, 120mA Linear Regulators

### ABSOLUTE MAXIMUM RATINGS

V <sub>IN</sub> to GND	-7V to +7V
Output Short-Circuit Duration	Infinite
SET to GND	-0.3V to +7V
SHDN to GND	-7V to +7V
SHDN to IN	-7V to 0.3V
OUT to GND	-0.3V to (V <sub>IN</sub> + 0.3V)
Continuous Power Dissipation (T <sub>A</sub> = +70°C)	
SOT23-5 (derate 7.1mW/°C above +70°C)	571mW

Operating Temperature Range	-40°C to +85°C
Junction Temperature	+150°C
Storage Temperature Range	-65°C to +160°C
Soldering Temperature	
Lead(Pb)-Free Packages	+260°C
Packages Containing Lead(Pb)	+240°C

Stresses beyond those listed under "Absolute Maximum Ratings" may cause permanent damage to the device. These are stress ratings only, and functional operation of the device at these or any other conditions beyond those indicated in the operational sections of the specifications is not implied. Exposure to absolute maximum rating conditions for extended periods may affect device reliability.

### PACKAGE THERMAL CHARACTERISTICS (Note 1)

SOT23

Junction-to-Ambient Thermal Resistance (θ<sub>JA</sub>) .....140°C/W

**Note 1:** Package thermal resistances were obtained using the method described in JEDEC specification JESD51-7, using a four layer board. For detailed information on package thermal considerations, refer to [www.maximintegrated.com/thermal-tutorial](http://www.maximintegrated.com/thermal-tutorial).

### ELECTRICAL CHARACTERISTICS

(V<sub>IN</sub> = +3.6V, T<sub>A</sub> = T<sub>MIN</sub> to T<sub>MAX</sub>, unless otherwise noted. Typical values are at T<sub>A</sub> = +25°C.) (Note 2)

PARAMETER	SYMBOL	CONDITIONS	MIN	TYP	MAX	UNITS	
Input Voltage (Note 3)	V <sub>IN</sub>		2.5		6.5	V	
Output Voltage	V <sub>OUT</sub>	0mA ≤ I <sub>OUT</sub> ≤ 50mA, SET = GND	MAX887_T	3.05	3.15	3.25	V
			MAX887_S	2.75	2.84	2.93	
			MAX887_R	2.70	2.80	2.88	
Adjustable Output Voltage Range (Note 4)	V <sub>OUT</sub>		V <sub>SET</sub>		6.5	V	
Maximum Output Current			120			mA	
Current Limit (Note 5)	I <sub>LIM</sub>			280		mA	
Ground Pin Current	I <sub>Q</sub>	SET = GND	I <sub>OUT</sub> = 0mA	73	150	µA	
			I <sub>OUT</sub> = 50mA	82			
Dropout Voltage (Note 6)		I <sub>OUT</sub> = 1mA		1.1		mV	
		I <sub>OUT</sub> = 50mA		55	120		
Line Regulation	ΔV <sub>LNR</sub>	V <sub>IN</sub> = 2.5V to 6.5V, SET tied to OUT, I <sub>OUT</sub> = 1mA	-0.15	0	0.15	%/V	
Load Regulation	ΔV <sub>LDR</sub>	I <sub>OUT</sub> = 0mA to 50mA	SET = GND	0.011	0.030	%/mA	
			SET tied to OUT	0.006			
Output Voltage Noise		10Hz to 1MHz	C <sub>OUT</sub> = 1µF	350		µVRMS	
			C <sub>OUT</sub> = 100µF	220			

### SHUTDOWN

SHDN Input Threshold	V <sub>IH</sub>		2.0			V
	V <sub>IL</sub>			0.4		
SHDN Input Bias Current	I <sub>SHDN</sub>	V <sub>SHDN</sub> = V <sub>IN</sub>	T <sub>A</sub> = +25°C	0	100	nA
			T <sub>A</sub> = T <sub>MAX</sub>	0.05		
Shutdown Supply Current	I <sub>QSHDN</sub>	V <sub>OUT</sub> = 0V	T <sub>A</sub> = +25°C	0.0001	1	µA
			T <sub>A</sub> = T <sub>MAX</sub>	0.02		
Shutdown Discharge Resistance (MAX8874)				300		Ω

# MAX8873T/S/R, MAX8874T/S/R

## Low-Dropout, 120mA Linear Regulators

### ELECTRICAL CHARACTERISTICS (continued)

( $V_{IN} = +3.6V$ ,  $T_A = T_{MIN}$  to  $T_{MAX}$ , unless otherwise noted. Typical values are at  $T_A = +25^\circ C$ .) (Note 2)

PARAMETER	SYMBOL	CONDITIONS	MIN	TYP	MAX	UNITS	
<b>SET INPUT</b>							
SET Reference Voltage (Note 4)	$V_{SET}$	$V_{IN} = 2.5V$ to $6.5V$ , $I_{OUT} = 1mA$	$T_A = +25^\circ C$	1.225	1.25	1.275	V
			$T_A = T_{MIN}$ to $T_{MAX}$	1.215	1.25	1.285	
SET Input Leakage Current (Note 4)	$I_{SET}$	$V_{SET} = 1.3V$	$T_A = +25^\circ C$	0.015	2.5	nA	
			$T_A = T_{MAX}$	0.5			
<b>THERMAL PROTECTION</b>							
Thermal Shutdown Temperature	$T_{SHDN}$			170		$^\circ C$	
Thermal Shutdown Hysteresis	$\Delta T_{SHDN}$			20		$^\circ C$	

**Note 2:** Limits are 100% production tested at  $T_A = +25^\circ C$ . Limits over the operating temperature range are guaranteed through correlation using Statistical Quality Control (SQC) methods.

**Note 3:** Guaranteed by line-regulation test.

**Note 4:** Adjustable mode only.

**Note 5:** For design purposes, the current limit should be considered 120mA minimum to 420mA maximum.

**Note 6:** The dropout voltage is defined as ( $V_{IN} - V_{OUT}$ ) when  $V_{OUT}$  is 100mV below the value of  $V_{OUT}$  for  $V_{IN} = V_{OUT} + 2V$ .

### Typical Operating Characteristics

( $V_{IN} = +3.6V$ ,  $C_{IN} = 1\mu F$ ,  $C_{OUT} = 1\mu F$ , MAX887\_T,  $T_A = +25^\circ C$ , unless otherwise noted.)

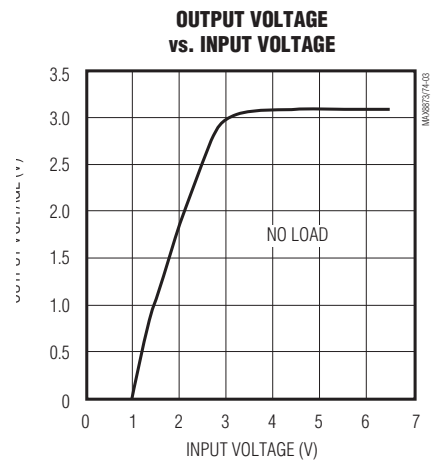
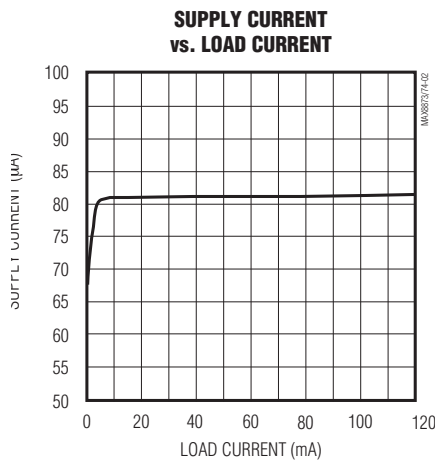
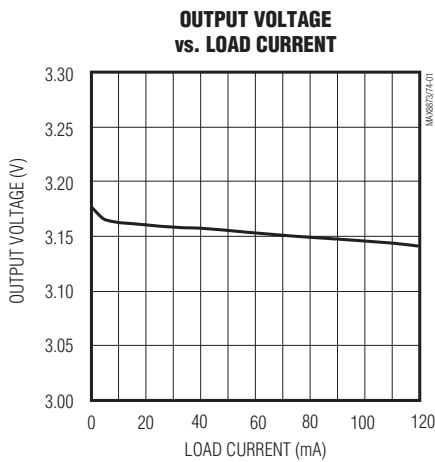

# MAX8873T/S/R, MAX8874T/S/R

## Low-Dropout, 120mA Linear Regulators

### Typical Operating Characteristics (continued)

( $V_{IN} = +3.6V$ ,  $C_{IN} = 1\mu F$ ,  $C_{OUT} = 1\mu F$ , MAX887\_T,  $T_A = +25^\circ C$ , unless otherwise noted.)

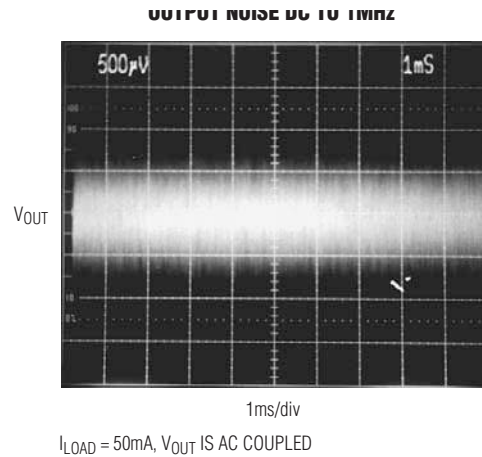
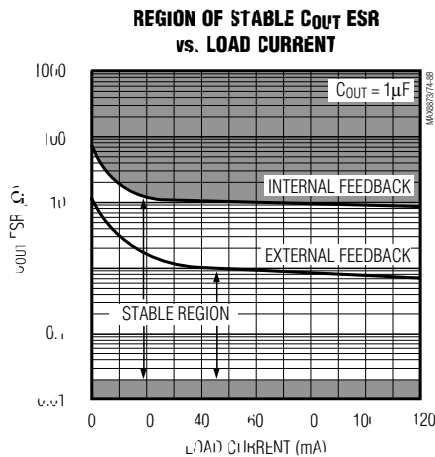
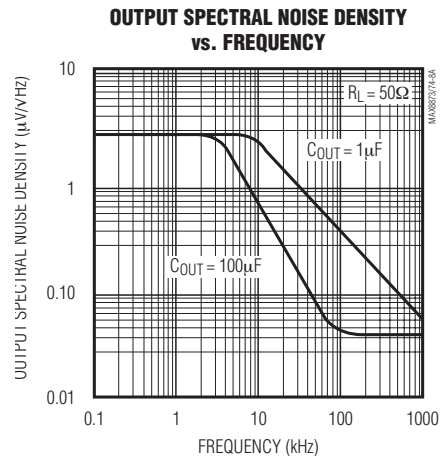
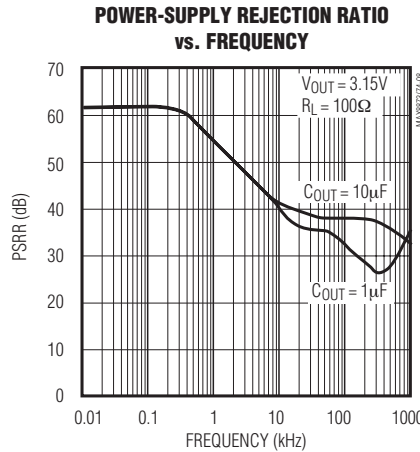
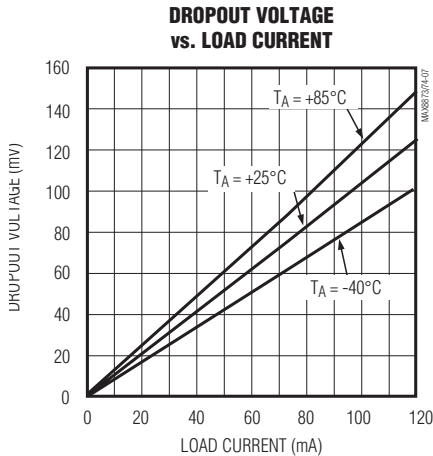
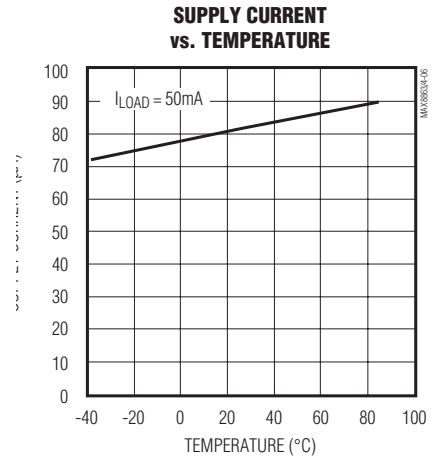
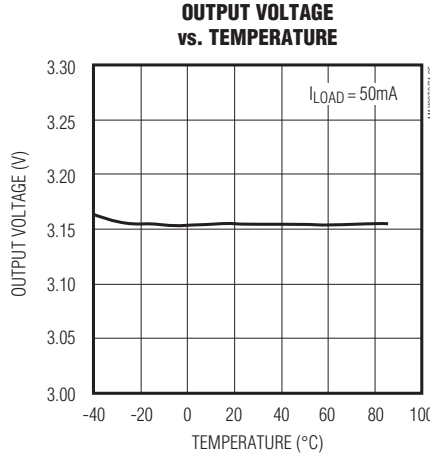
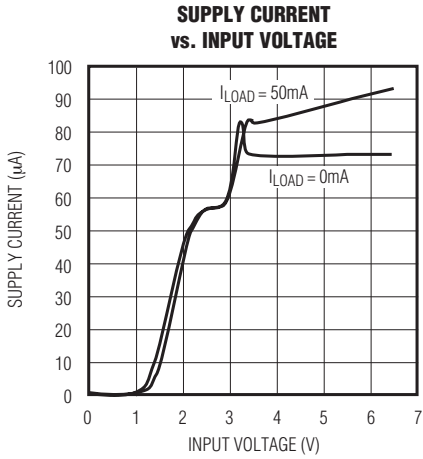

# MAX8873T/S/R, MAX8874T/S/R

## Low-Dropout, 120mA Linear Regulators

### Typical Operating Characteristics (continued)

( $V_{IN} = +3.6V$ ,  $C_{IN} = 1\mu F$ ,  $C_{OUT} = 1\mu F$ , MAX887\_T,  $T_A = +25^\circ C$ , unless otherwise noted.)

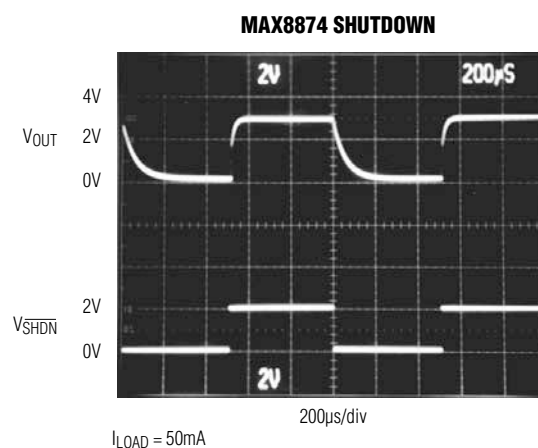
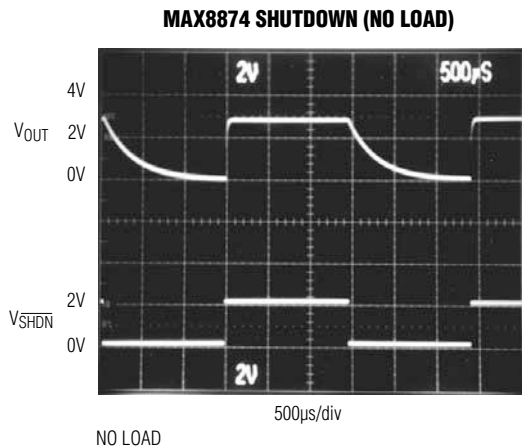
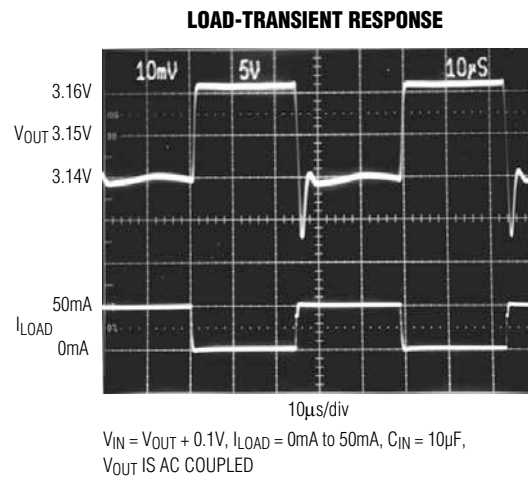
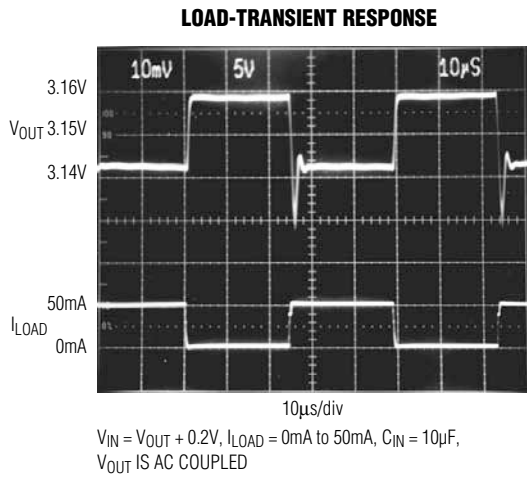
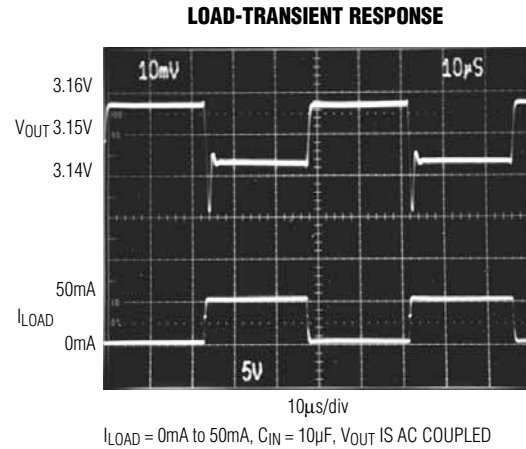
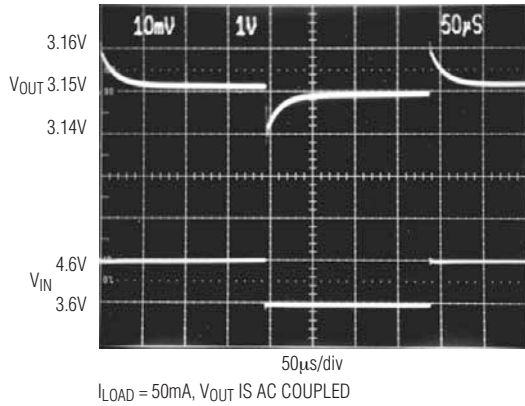

# MAX8873T/S/R, MAX8874T/S/R

## Low-Dropout, 120mA Linear Regulators

### Pin Description

PIN	NAME	FUNCTION
1	IN	Regulator Input. Supply voltage can range from 2.5V to 6.5V. Bypass with 1 $\mu$ F to GND (see <i>Capacitor Selection and Regulator Stability</i> ).
2	GND	Ground. This pin also functions as a heatsink. Solder to large pads or the circuit board ground plane to maximize thermal dissipation.
3	SHDN	Active-Low Shutdown Input. A logic low reduces the supply current to 0.1nA. On the MAX8874, a logic low also causes the output voltage to discharge to GND. Connect to IN for normal operation.
4	SET	Feedback Input for Setting the Output Voltage. Connect to GND to set the output voltage to the preset 2.80V (MAX887_R), 2.84V (MAX887_S), or 3.15V (MAX887_T). Connect to an external resistor divider for adjustable-output operation. <b>DO NOT LEAVE THIS PIN UNCONNECTED.</b>
5	OUT	Regulator Output. Fixed or adjustable from 1.25V to 6.5V. Sources up to 120mA. Bypass with a 1 $\mu$ F, <0.2 $\Omega$ typical ESR capacitor to GND.

### Detailed Description

The MAX8873/MAX8874 are low-dropout, low-quiescent-current linear regulators designed primarily for battery-powered applications. They supply an adjustable 1.25V to 6.5V output or a preselected 2.80V (MAX887\_R), 2.84V (MAX887\_S), or 3.15V (MAX887\_T) output for load currents up to 120mA. These devices consist of a 1.25V reference, error amplifier, MOSFET driver, P-channel pass transistor, dual-mode comparator, and internal feedback voltage divider (Figure 1).

The 1.25V bandgap reference is connected to the error amplifier's inverting input. The error amplifier compares this reference with the selected feedback voltage and amplifies the difference. The MOSFET driver reads the error signal

and applies the appropriate drive to the P-channel pass transistor. If the feedback voltage is lower than the reference, the pass-transistor gate is pulled lower, allowing more current to pass and increasing the output voltage. If the feedback voltage is too high, the pass-transistor gate is pulled up, allowing less current to pass to the output.

The output voltage is fed back through either an internal resistor voltage divider connected to the OUT pin, or an external resistor network connected to the SET pin. The dual-mode comparator examines the SET voltage and selects the feedback path. If SET is below 60mV, internal feedback is used and the output voltage is regulated to the preset output voltage. Additional blocks include a current limiter, reverse battery protection, thermal sensor, and shutdown logic.

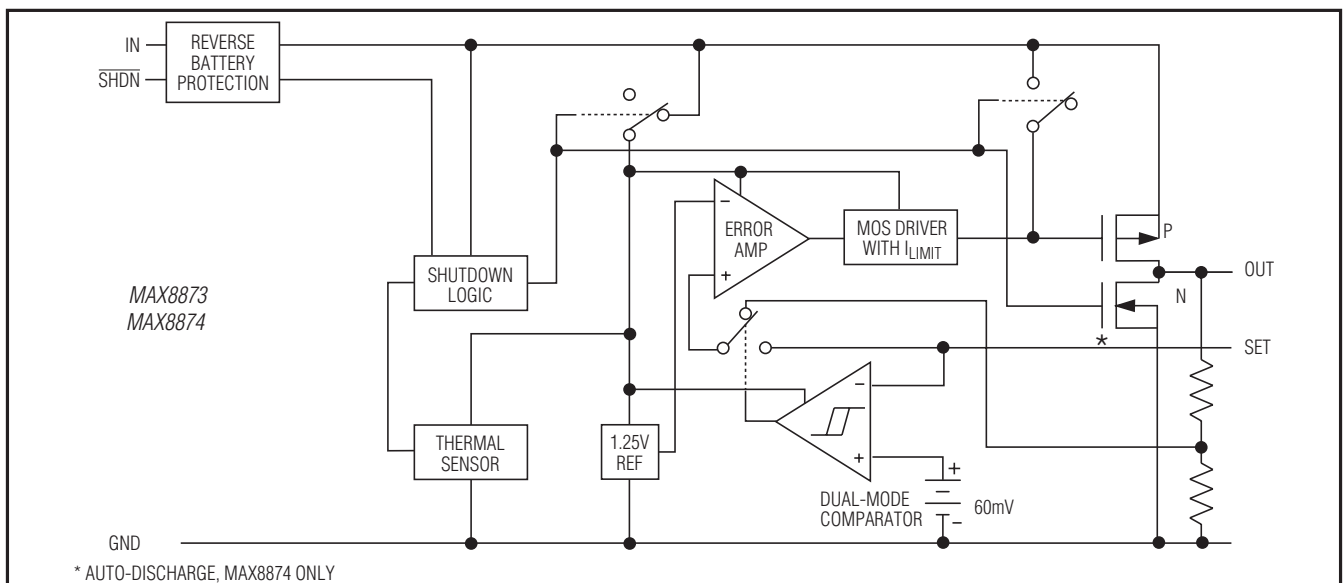

Figure 1. Functional Diagram

# MAX8873T/S/R, MAX8874T/S/R

## Low-Dropout, 120mA Linear Regulators

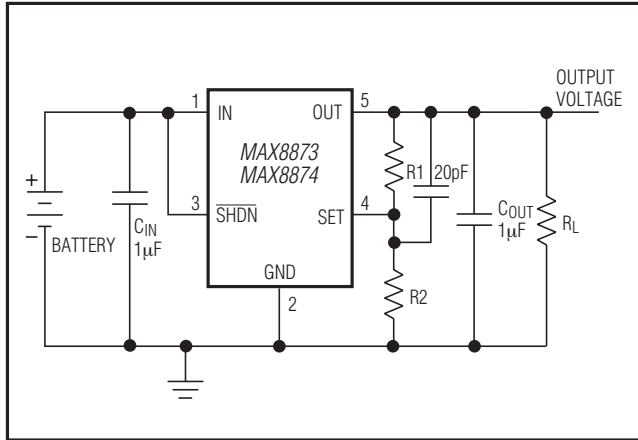

Figure 2. Adjustable Output Using External Feedback Resistors

### Internal P-Channel Pass Transistor

The MAX8873/MAX8874 feature a 1.1 $\Omega$  typical P-channel MOSFET pass transistor. This provides several advantages over similar designs using PNP pass transistors, including longer battery life.

The P-channel MOSFET requires no base drive current, which reduces quiescent current considerably. PNP-based regulators waste considerable amounts of current in dropout when the pass transistor saturates. They also use high base-drive currents under large loads. The MAX8873/MAX8874 do not suffer from these problems, and consume only 82 $\mu$ A of quiescent current, whether in dropout, light load, or heavy load applications (see *Typical Operating Characteristics*).

### Output Voltage Selection

The MAX8873/MAX8874 feature Dual Mode operation: they operate in either a preset voltage mode or an adjustable mode.

In preset voltage mode, internal, trimmed feedback resistors set the MAX887\_R output to 2.80V, the MAX887\_S output to 2.84V, and the MAX887\_T output to 3.15V. Select this mode by connecting SET to ground.

In adjustable mode, select an output between 1.25V and 6.5V using two external resistors connected as a voltage divider to SET (Figure 2). The output voltage is set by the following equation:

$$V_{OUT} = V_{SET} (1 + R1 / R2)$$

where  $V_{SET} = 1.25V$ . To simplify resistor selection:

$$R1 = R2 \left( \frac{V_{OUT}}{V_{SET}} - 1 \right)$$

Choose  $R2 = 100k\Omega$  to optimize power consumption, accuracy, and high-frequency power-supply rejection. The total current through the external resistive feedback and load resistors should not be less than 10 $\mu$ A. Since the  $V_{SET}$  tolerance is typically less than  $\pm 25mV$ , the output can be set using fixed resistors instead of trim pots. Connect a 10pF to 25pF capacitor across R1 to compensate for layout-induced parasitic capacitances.

In preset voltage mode, impedances between SET and ground should be less than 100k $\Omega$ . Otherwise, spurious conditions could cause the voltage at SET to exceed the 60mV dual-mode threshold.

### Shutdown

A low input on the  $\overline{SHDN}$  pin shuts down the MAX8873/MAX8874. In shutdown mode, the pass transistor, control circuit, reference, and all biases are turned off, reducing the supply current to typically 0.1nA. Connect SHDN to IN for normal operation. The MAX8874 output voltage is actively discharged to ground when the part is placed in shutdown (see *Typical Operating Characteristics*).

### Current Limit

The MAX8873/MAX8874 include a current limiter that monitors and controls the pass transistor's gate voltage, estimating the output current and limiting it to about 280mA. For design purposes, the current limit should be considered 120mA to 420mA. The output can be shorted to ground for an indefinite time period without damaging the part.

### Thermal Overload Protection

Thermal overload protection limits total power dissipation in the MAX8873/MAX8874. When the junction temperature exceeds  $T_J = +170^\circ C$ , the thermal sensor sends a signal to the shutdown logic, turning off the pass transistor and allowing the IC to cool. The thermal sensor turns the pass transistor on again after the IC's junction temperature typically cools by 20 $^\circ C$ , resulting in a pulsed output during continuous thermal overload conditions.

Thermal overload protection is designed to protect the MAX8873/MAX8874 in the event of fault conditions. Stressing the device with high load currents and high input-output differential voltages (which result in die temperatures above +125 $^\circ C$ ) may cause a momentary overshoot (2% to 8% for 200ms) when the load is completely removed. This can be remedied by raising the minimum load current from 0 $\mu$ A (+125 $^\circ C$ ) to 100 $\mu$ A (+150 $^\circ C$ ). For continuous operation, do not exceed the absolute maximum junction temperature rating of  $T_J = +150^\circ C$ .

# MAX8873T/S/R, MAX8874T/S/R

## Low-Dropout, 120mA Linear Regulators

### Operating Region and Power Dissipation

Maximum power dissipation of the MAX8873/MAX8874 depends on the thermal resistance of the case and circuit board, the temperature difference between the die junction and ambient air, and the rate of air flow. The power dissipation across the device is  $P = I_{OUT}(V_{IN} - V_{OUT})$ . The resulting maximum power dissipation is:

$$P_{MAX} = (T_J - T_A) / \theta_{JA}$$

where  $(T_J - T_A)$  is the temperature difference between the MAX8873/MAX8874 die junction and the surrounding air, and  $\theta_{JA}$  is the thermal resistance of the chosen package to the surrounding air.

The GND pin of the MAX8873/MAX8874 performs the dual function of providing an electrical connection to ground and channeling heat away. Connect the GND pin to ground using a large pad or ground plane.

### Reverse Battery Protection

The MAX8873/MAX8874 have a unique protection scheme that limits the reverse supply current to less than 1mA when either  $V_{IN}$  or  $\overline{VSHDN}$  falls below ground. The circuitry monitors the polarity of these two pins, disconnecting the internal circuitry and parasitic diodes when the battery is reversed. This feature prevents the device from overheating and damaging the battery.

### $V_{IN} > 5.5V$ Minimum Load Current

When operating the MAX8873/MAX8874 with an input voltage above 5.5V, a minimum load current of 20 $\mu$ A is required to maintain regulation in preset voltage mode. When setting the output with external resistors, the minimum current through the external feedback resistors and load must be 30 $\mu$ A.

## Applications Information

### Capacitor Selection and Regulator Stability

Normally, use a 1 $\mu$ F capacitor on the input and a 1 $\mu$ F capacitor on the output of the MAX8873/MAX8874. Larger input capacitor values and lower ESR provide better supply-noise rejection and transient response. A higher-value input capacitor (10 $\mu$ F) may be necessary if large, fast transients are anticipated and the device is located several inches from the power source. Improve load-transient response, stability, and power-supply rejection by using large output capacitors. For stable operation over the full temperature range, with load currents up to 120mA, a minimum of 1 $\mu$ F is recommended.

### Noise

The MAX8873/MAX8874 exhibit 350 $\mu$ V<sub>RMS</sub> noise during normal operation. When using the MAX8873/MAX8874 in applications that include analog-to-digital converters (ADCs) of greater than 12 bits, consider the ADC's power-supply rejection specifications (see the Output Noise DC to 1MHz photo in the *Typical Operating Characteristics*). For devices with lower output noise, refer to the MAX8877/MAX8878.

### Power-Supply Rejection and Operation from Sources Other than Batteries

The MAX8873/MAX8874 are designed to deliver low dropout voltages and low quiescent currents in battery-powered systems. Power-supply rejection is 62dB at low frequencies and rolls off above 300Hz. As the frequency increases above 20kHz, the output capacitor is the major contributor to the rejection of power-supply noise (see the Power-Supply Rejection Ratio vs. Frequency graph in the *Typical Operating Characteristics*).

When operating from sources other than batteries, improve supply-noise rejection and transient response by increasing the values of the input and output capacitors, and by using passive filtering techniques (see the supply and load-transient responses in the *Typical Operating Characteristics*).

### Load-Transient Considerations

The MAX8873/MAX8874 load-transient response graphs (see *Typical Operating Characteristics*) show two components of the output response: a DC shift of the output voltage due to the different load currents and the transient response. Typical overshoot for step changes in the load current from 0mA to 50mA is 14mV. Increasing the output capacitor's value and decreasing its ESR attenuates transient spikes.

### Input-Output (Dropout) Voltage

A regulator's minimum input-output voltage differential (or dropout voltage) determines the lowest usable supply voltage. In battery-powered systems, this will determine the useful end-of-life battery voltage. Because the MAX8873/MAX8874 use a P-channel MOSFET pass transistor, their dropout voltage is a function of  $R_{DS(ON)}$  multiplied by the load current (see *Electrical Characteristics*).



# **MAX8873T/S/R, MAX8874T/S/R**

## **Low-Dropout, 120mA Linear Regulators**

### **Package Information**

For the latest package outline information and land patterns (footprints), go to [www.maximintegrated.com/packages](http://www.maximintegrated.com/packages). Note that a "+", "#", or "-" in the package code indicates RoHS status only. Package drawings may show a different suffix character, but the drawing pertains to the package regardless of RoHS status.

<b>PACKAGE TYPE</b>	<b>PACKAGE CODE</b>	<b>OUTLINE NO.</b>	<b>LAND PATTERN NO.</b>
6 SOT23	U6F-6	<a href="#">21-0058</a>	<a href="#">90-0175</a>

# MAX8873T/S/R, MAX8874T/S/R

## Low-Dropout, 120mA Linear Regulators

### Revision History

REVISION NUMBER	REVISION DATE	DESCRIPTION
2	3/13	Added lead-free and automotive designations, added <i>Package Thermal Characteristics</i> , <i>Package Information</i> , and <i>Revision History</i> sections, and removed <i>Chip Information</i> section



Maxim Integrated cannot assume responsibility for use of any circuitry other than circuitry entirely embodied in a Maxim Integrated product. No circuit patent licenses are implied. Maxim Integrated reserves the right to change the circuitry and specifications without notice at any time. The parametric values (min and max limits) shown in the Electrical Characteristics table are guaranteed. Other parametric values quoted in this data sheet are provided for guidance.

## X-ON Electronics

Largest Supplier of Electrical and Electronic Components

*Click to view similar products for [LDO Voltage Regulators](#) category:*

*Click to view products by [Maxim](#) manufacturer:*

Other Similar products are found below :

[AP7363-SP-13](#) [L79M05TL-E](#) [PT7M8202B12TA5EX](#) [TCR3DF185,LM\(CT](#) [TCR3DF24,LM\(CT](#) [TCR3DF285,LM\(CT](#) [TCR3DF31,LM\(CT](#)  
[TCR3DF45,LM\(CT](#) [MP2013GQ-33-Z](#) [059985X](#) [NCP4687DH15T1G](#) [701326R](#) [TCR2EN28,LF\(S](#) [NCV8170AXV250T2G](#)  
[TCR3DF27,LM\(CT](#) [TCR3DF19,LM\(CT](#) [TCR3DF125,LM\(CT](#) [TCR2EN18,LF\(S](#) [AP7315-25W5-7](#) [IFX30081LDVGRNXUMA1](#)  
[NCV47411PAAJR2G](#) [AP2113KTR-G1](#) [AP2111H-1.2TRG1](#) [ZLDO1117QK50TC](#) [AZ1117IH-1.8TRG1](#) [TCR3DG12,LF](#) [MIC5514-3.3YMT-](#)  
[T5](#) [MIC5512-1.2YMT-T5](#) [MIC5317-2.8YM5-T5](#) [SCD7912BTG](#) [NCP154MX180270TAG](#) [SCD33269T-5.0G](#) [NCV8170BMX330TCG](#)  
[NCV8170AMX120TCG](#) [NCP706ABMX300TAG](#) [NCP153MX330180TCG](#) [NCP114BMX075TCG](#) [MC33269T-3.5G](#) [CAT6243-ADJCMT5T](#)  
[TCR3DG33,LF](#) [AP2127N-1.0TRG1](#) [TCR4DG35,LF](#) [LT1117CST-3.3](#) [LT1117CST-5](#) [TAR5S15U\(TE85L,F\)](#) [TAR5S18U\(TE85L,F\)](#)  
[TCR3UG19A,LF](#) [TCR4DG105,LF](#) [NCV8170AMX360TCG](#) [MIC94310-NYMT-T5](#)