



# Low-Power Single/Dual, Rail-to-Rail Op Amps

MAX9614/MAX9616

## General Description

The MAX9614/MAX9616 are low-power precision op amps that feature precision MOS inputs.

These devices are ideal for a large number of signal processing applications such as photodiode transimpedance amplifiers and filtering/amplification of a wide variety of signals in industrial equipment. The devices also feature excellent RF immunity, making them ideal for portable applications.

The MAX9614/MAX9616 are capable of operating from a 2.5V to 5.5V supply voltage over the -40°C to +125°C automotive temperature range.

Both singles and duals are available in tiny SC70 packages. The MAX9614 features an active-low shutdown pin.

## Applications

- Notebooks, Portable Media Players
- Industrial and Medical Sensors
- General Purpose Signal Processing

## Features

- ◆  $V_{CC} = 2.5V$  to  $5.5V$  ( $-40^{\circ}C$  to  $+125^{\circ}C$ )
- ◆ Low  $100\mu V$  (max)  $V_{OS}$
- ◆  $1\mu A$  Supply Current in Shutdown,  $175\mu A$  Operating
- ◆ Small SC70 Package
- ◆ 2.8MHz Bandwidth
- ◆ Excellent RF Immunity

## Ordering Information

PART	TEMP RANGE	PIN-PACKAGE	TOP MARK
MAX9614AXT+T	-40°C to +125°C	6 SC70	+ADL
MAX9616AXA+T	-40°C to +125°C	8 SC70	+AAE

+ Denotes lead(Pb)-free/RoHS-compliant package.  
T = Tape and reel.

## Typical Application Circuit

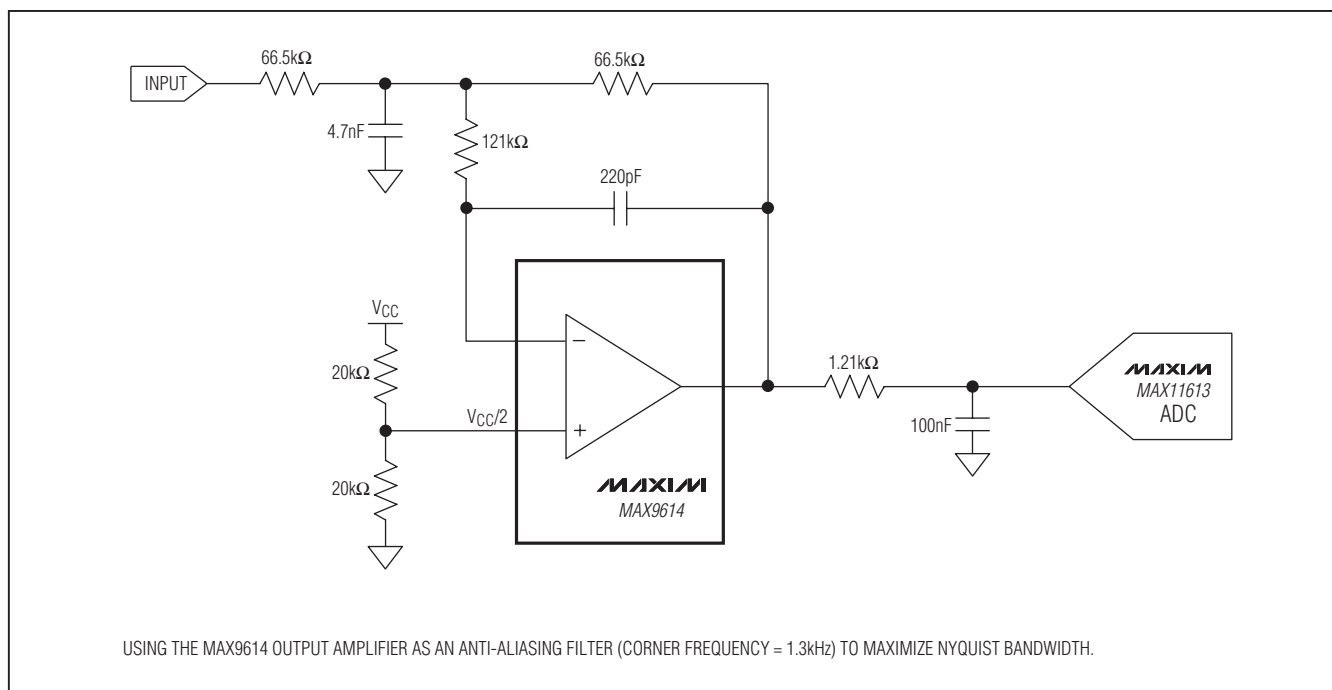

# Low-Power Single/Dual, Rail-to-Rail Op Amps

## ABSOLUTE MAXIMUM RATINGS

IN+, IN-, $\overline{\text{SHDN}}$ , VCC to GND.....	-0.3V to +6V	8-Pin SC70 (derate 3.1mW/°C above +70°C).....	245mW
OUT to GND .....	-0.3V to VCC + 0.3V	$\theta_{\text{JA}}$ .....	326°C/W
Short-Circuit (GND) Duration, OUT, OUTA, OUTB.....	5s	$\theta_{\text{JC}}$ .....	115°C/W
Continuous Input Current (any pin).....	±20mA	Operating Temperature Range.....	-40°C to +125°C
Thermal Limits (Note 1) Multilayer PCB		Junction Temperature .....	+150°C
Continuous Power Dissipation (TA = +70°C)		Lead Temperature (soldering, 10s).....	+300°C
6-Pin SC70 (derate 3.1mW/°C above +70°C).....	245mW	Soldering Temperature (reflow) .....	+240°C
$\theta_{\text{JA}}$ .....	326.5°C/W		
$\theta_{\text{JC}}$ .....	115°C/W		

**Note 1:** Package thermal resistances were obtained using the method described in JEDEC specification JESD51-7, using a 4-layer board. For detailed information on package thermal considerations, refer to [www.maxim-ic.com/thermal-tutorial](http://www.maxim-ic.com/thermal-tutorial).

Stresses beyond those listed under "Absolute Maximum Ratings" may cause permanent damage to the device. These are stress ratings only, and functional operation of the device at these or any other conditions beyond those indicated in the operational sections of the specifications is not implied. Exposure to absolute maximum rating conditions for extended periods may affect device reliability.

## ELECTRICAL CHARACTERISTICS

(VCC =  $\overline{\text{VSHDN}}$  = 3.3V, VIN+ = VIN- = VCM = GND, RL = 10k $\Omega$  to VCC/2, TA = -40°C to +125°C. Typical values are at TA = +25°C, unless otherwise noted.) (Note 2)

PARAMETER	SYMBOL	CONDITIONS	MIN	TYP	MAX	UNITS
<b>DC CHARACTERISTICS</b>						
Input Voltage Range	VIN+, VIN-	Guaranteed by CMRR test	-0.1		VCC - 1.4	V
Input Offset Voltage	VOS	TA = +25°C		17	100	$\mu\text{V}$
		TA = -40°C to +125°C, after power-up autocalibration			165	
		TA = -40°C to +125°C			750	
Input Offset Voltage Drift	VOS - TC		1	7.5		$\mu\text{V}/^\circ\text{C}$
Input Bias Current (Note 3)	IB	TA = -40°C to +25°C		1	1.55	pA
		TA = +70°C			45	
		TA = +85°C			135	nA
		TA = +125°C			1.55	
Input Offset Current (Note 3)	IOS	TA = -40°C to +25°C			0.5	pA
		TA = +70°C			7	
		TA = +85°C			25	
		TA = +125°C			4000	
Common-Mode Rejection Ratio	CMRR	VCM = -0.1V to VCC - 1.4V, TA = +25°C	80	95		dB
		VCM = -0.1V to VCC - 1.4V, TA = -40°C to +125°C	78			
Open-Loop Gain	AOL	+0.4V ≤ VOUT ≤ VCC - 0.4V, RL = 10k $\Omega$	99	115		dB
		+0.4V ≤ VOUT ≤ VCC - 0.4V, RL = 600 $\Omega$	93	110		
Output Short-Circuit Current (Note 4)	ISC	To VCC		275		mA
		To GND		75		
Output Voltage Low	VOL	RL = 10k $\Omega$		1	11	mV
		RL = 600 $\Omega$		11	100	
		RL = 32 $\Omega$		170		

# Low-Power Single/Dual, Rail-to-Rail Op Amps

MAX9614/MAX9616

## ELECTRICAL CHARACTERISTICS (continued)

( $V_{CC} = \overline{VSHDN} = 3.3V$ ,  $V_{IN+} = V_{IN-} = V_{CM} = GND$ ,  $R_L = 10k\Omega$  to  $V_{CC}/2$ ,  $T_A = -40^\circ C$  to  $+125^\circ C$ . Typical values are at  $T_A = +25^\circ C$ , unless otherwise noted.) (Note 2)

PARAMETER	SYMBOL	CONDITIONS	MIN	TYP	MAX	UNITS
Output Voltage High	VOH	$R_L = 10k\Omega$	$V_{CC} - 11$	$V_{CC} - 2$		mV
		$R_L = 600\Omega$	$V_{CC} - 100$	$V_{CC} - 30$		
		$R_L = 32\Omega$		$V_{CC} - 560$		
<b>AC CHARACTERISTICS</b>						
Input Voltage Noise Density	$e_n$	$f = 10kHz$		28		$nV/\sqrt{Hz}$
Input Voltage Noise	Total noise	$0.1Hz \leq f \leq 10Hz$		5		$\mu VP-P$
Input Current Noise Density	$I_n$	$f = 10kHz$		0.1		$fA/\sqrt{Hz}$
Gain Bandwidth	GBW			2.8		MHz
Slew Rate	SR			1.3		$V/\mu s$
Capacitive Loading	$C_{LOAD}$	No sustained oscillation		200		pF
Total Harmonic Distortion	THD	$f = 10kHz$ , $V_{OUT} = 2VP-P$ , $A_V = 1V/V$		-85		dB
<b>POWER-SUPPLY CHARACTERISTICS</b>						
Power-Supply Range	$V_{CC}$	Guaranteed by PSRR	2.5		5.5	V
Power-Supply Rejection Ratio	PSRR	$T_A = +25^\circ C$	85	106		dB
		$T_A = -40^\circ C$ to $+125^\circ C$	83			
Quiescent Current	$I_{CC}$	$T_A = +25^\circ C$ , per amplifier		170	255	$\mu A$
		$T_A = -40^\circ C$ to $+125^\circ C$ , per amplifier			350	
Shutdown Supply Current	$I_{SHDN}$	MAX9614 only			1	$\mu A$
Shutdown Input Low	$V_{IL}$	MAX9614 only			0.5	V
Shutdown Input High	$V_{IH}$	MAX9614 only	1.4			V
Output Impedance in Shutdown	$R_{OUT\_SHDN}$	MAX9614 only		10		$M\Omega$
Turn-On Time from $\overline{SHDN}$	$t_{ON}$	MAX9614 only		20		$\mu s$
Power-Up Time	$t_{UP}$			10		ms

**Note 2:** All devices are 100% production tested at  $T_A = +25^\circ C$ . Temperature limits are guaranteed by design.

**Note 3:** Guaranteed by design, not production tested.

**Note 4:** Do not exceed package thermal dissipation in the *Absolute Maximum Ratings* section.

# Low-Power Single/Dual, Rail-to-Rail Op Amps

## Typical Operating Characteristics

( $V_{CC} = 3.3V$ ,  $V_{IN+} = V_{IN-} = 0V$ ,  $V_{CM} = V_{CC}/2$ ,  $R_L = 10k\Omega$  to  $V_{CC}/2$ , values are at  $T_A = +25^\circ C$ , unless otherwise noted.)

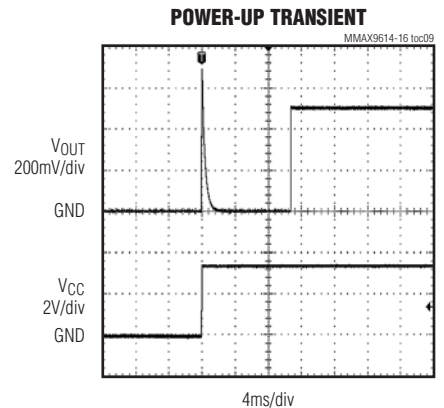
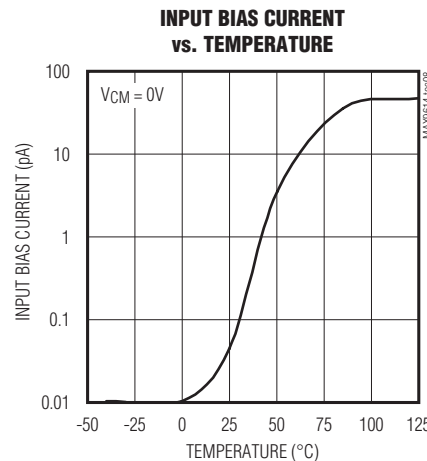
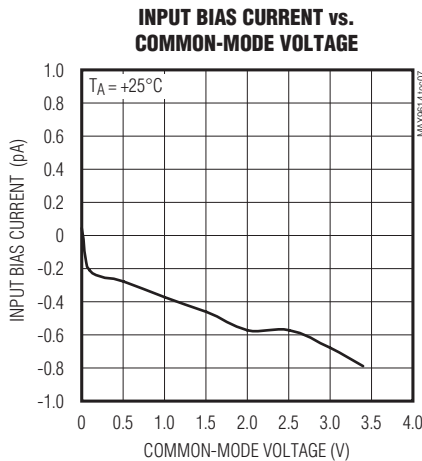
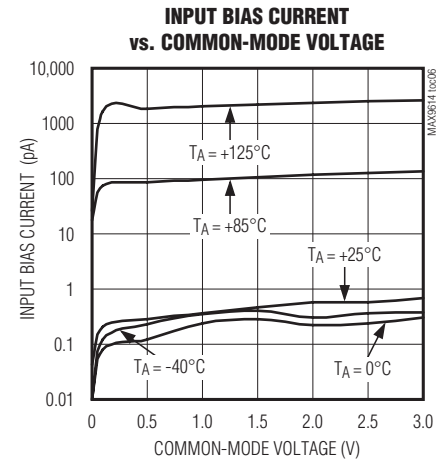
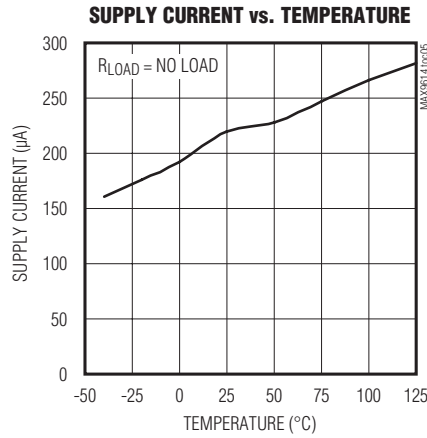
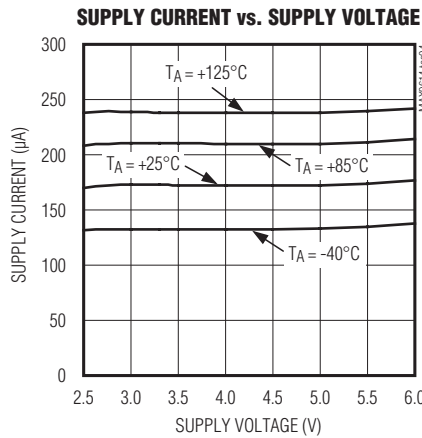
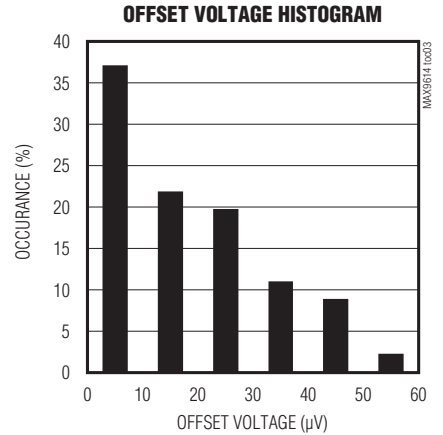
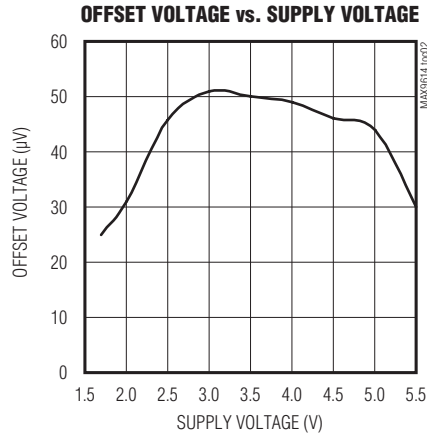
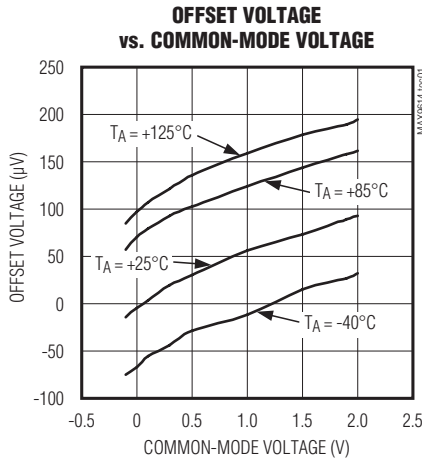

# Low-Power Single/Dual, Rail-to-Rail Op Amps

## Typical Operating Characteristics (continued)

( $V_{CC} = 3.3V$ ,  $V_{IN+} = V_{IN-} = 0V$ ,  $V_{CM} = V_{CC}/2$ ,  $R_L = 10k\Omega$  to  $V_{CC}/2$ , values are at  $T_A = +25^\circ C$ , unless otherwise noted.)

MAX9614/MAX9616

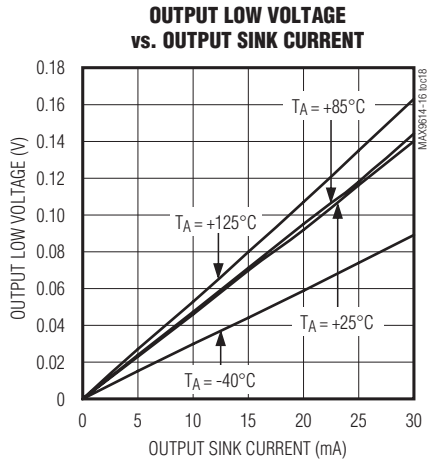
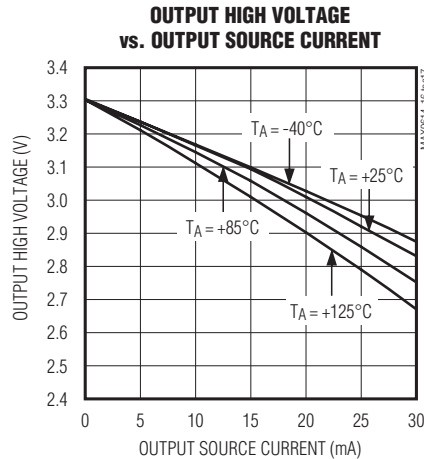
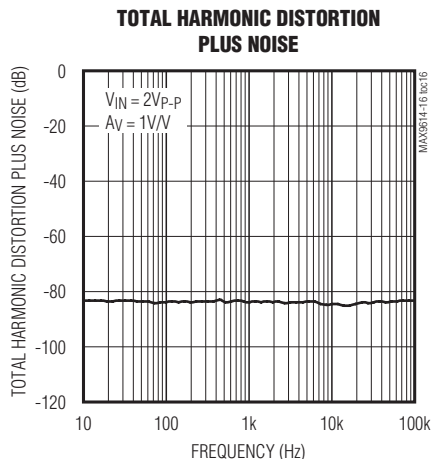
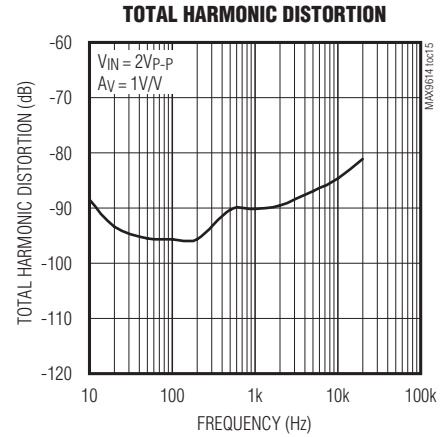
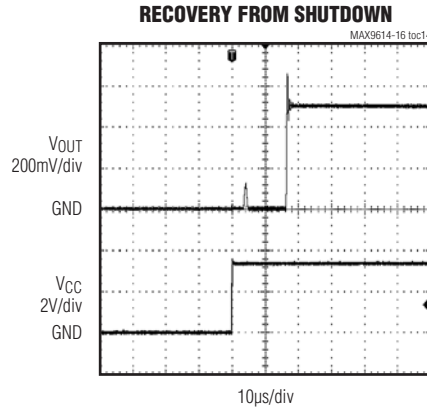
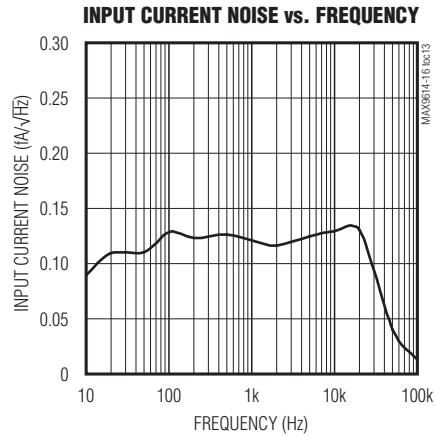
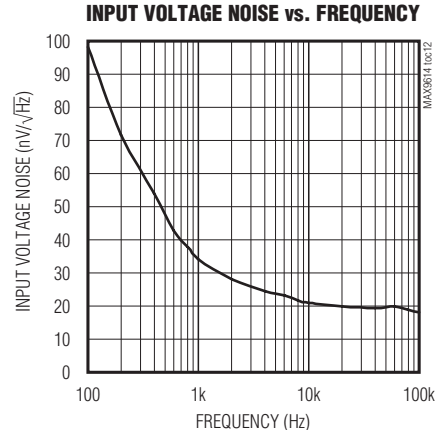
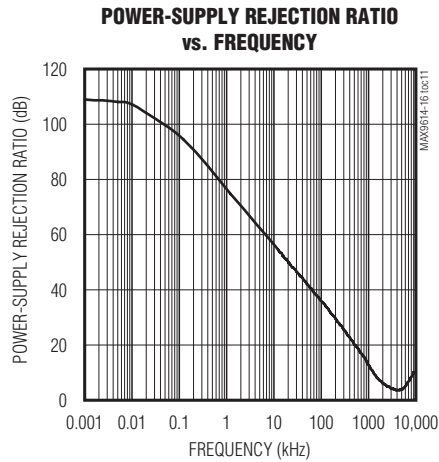
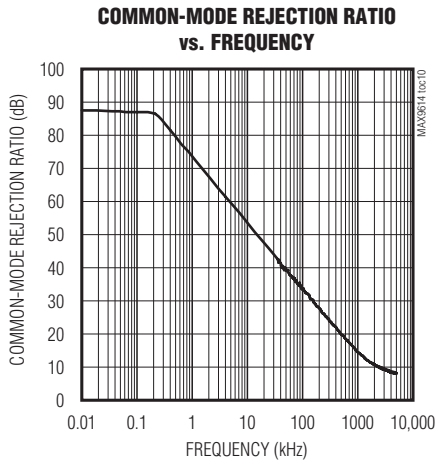

# Low-Power Single/Dual, Rail-to-Rail Op Amps

## Typical Operating Characteristics (continued)

( $V_{CC} = 3.3V$ ,  $V_{IN+} = V_{IN-} = 0V$ ,  $V_{CM} = V_{CC}/2$ ,  $R_L = 10k\Omega$  to  $V_{CC}/2$ , values are at  $T_A = +25^\circ C$ , unless otherwise noted.)

0.1Hz TO 10Hz NOISE

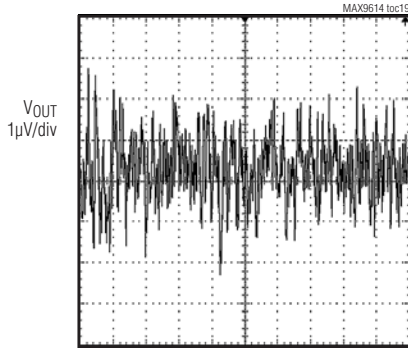

OPEN-LOOP GAIN vs. FREQUENCY

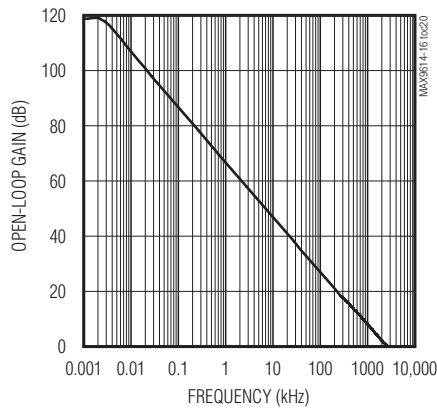

STABILITY vs. CAPACITIVE AND RESISTIVE LOAD IN PARALLEL

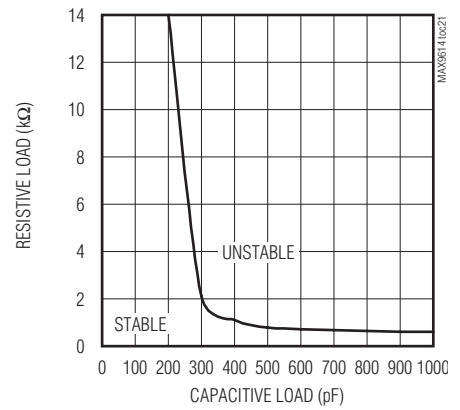

STABILITY vs. CAPACITIVE WITH SERIES ISOLATION RESISTOR

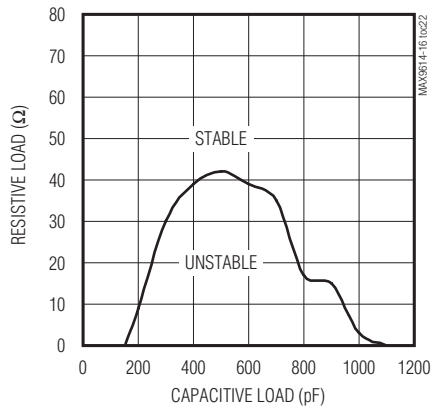

100mV STEP RESPONSE  
 $C_{LOAD} = 200pF$

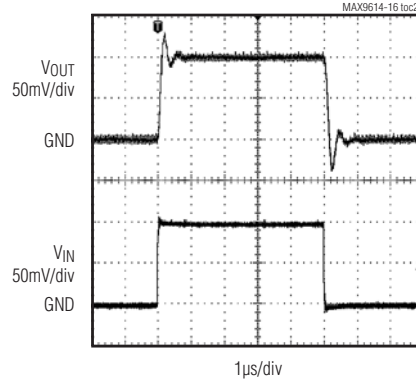

2V STEP RESPONSE  
 $C_{LOAD} = 200pF$

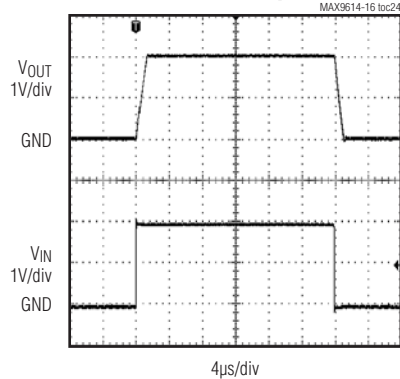

RECOVERY FROM SATURATION  
OUTPUT SATURATED TO GND

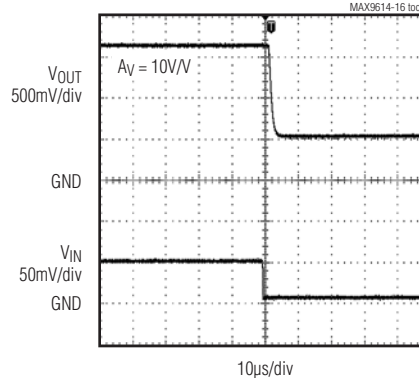

# Low-Power Single/Dual, Rail-to-Rail Op Amps

MAX9614/MAX9616

## Typical Operating Characteristics (continued)

( $V_{CC} = 3.3V$ ,  $V_{IN+} = V_{IN-} = 0V$ ,  $V_{CM} = V_{CC}/2$ ,  $R_L = 10k\Omega$  to  $V_{CC}/2$ , values are at  $T_A = +25^\circ C$ , unless otherwise noted.)

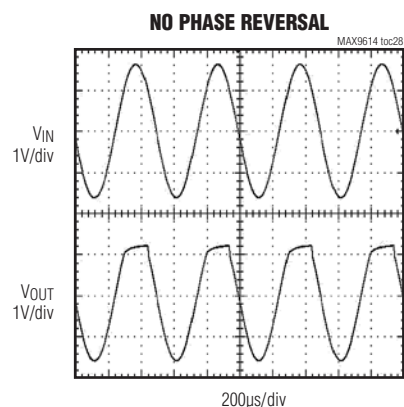
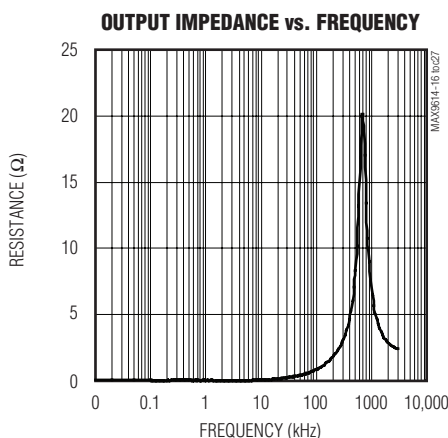
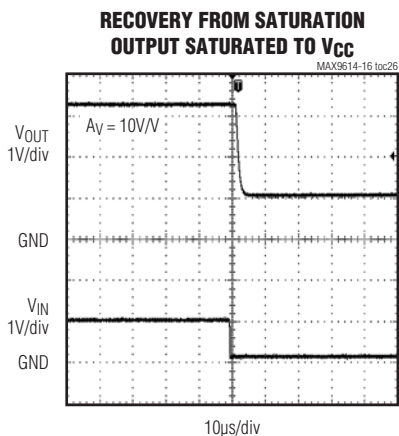

## Pin Configuration

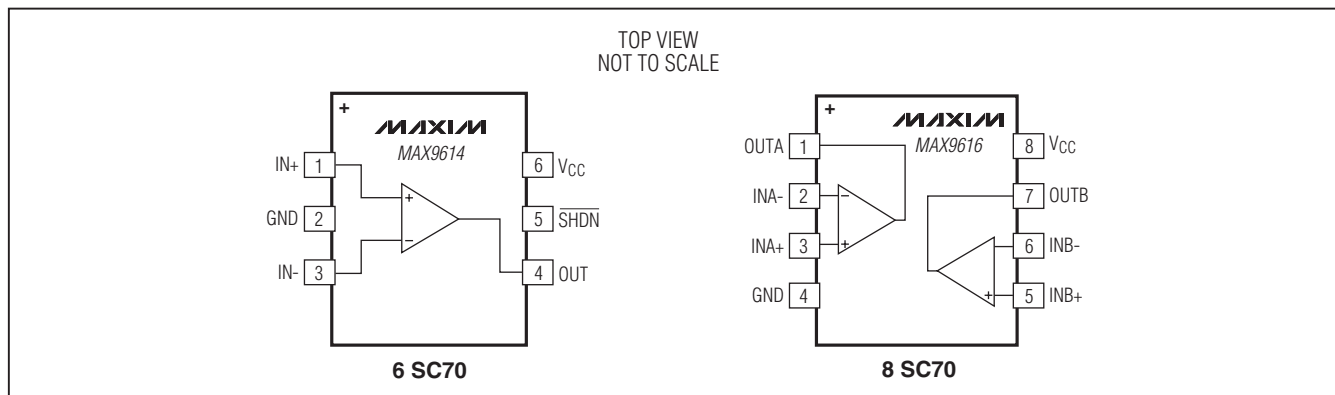

## Pin Description

PIN		NAME	FUNCTION
MAX9614	MAX9616		
1	—	IN+	Positive Input
—	3	INA+	Positive Input A
—	5	INB+	Positive Input B
2	4	GND	Ground
3	—	IN-	Negative Input
—	2	INA-	Negative Input A
—	6	INB-	Negative Input B
4	—	OUT	Output
—	1	OUTA	Output A
—	7	OUTB	Output B
5	—	SHDN	Active-Low Shutdown
6	8	VCC	Positive Power Supply. Bypass with a 0.1µF capacitor to ground.

# Low-Power Single/Dual, Rail-to-Rail Op Amps

## Detailed Description

The MAX9614/MAX9616 are low-power op amps ideal for signal processing applications due to the devices' high precision and CMOS inputs.

The MAX9614 also features a low-power shutdown mode that greatly reduces quiescent current while the device is not operational.

The MAX9614/MAX9616 self-calibrate on power-up to eliminate effects of temperature and power-supply variation.

### RF Immunity

The MAX9614/MAX9616 feature robust internal EMI filters that reduce the devices' susceptibility to high-frequency RF signals such as from wireless and mobile devices. This, combined with excellent DC and AC specifications, makes these devices ideal for a wide variety of portable audio and sensitive signal-conditioning applications.

## Applications Information

### Power-Up Autotrim

The MAX9614/MAX9616 feature an automatic power-up autotrim that self-calibrates the  $V_{OS}$  of these devices to less than  $100\mu\text{V}$  of input offset voltage. The autotrim sequence takes approximately 10ms to complete, and is triggered by an internal power-on reset (POR) circuitry. During this time, the inputs and outputs are put into high impedance and left unconnected. This self-calibration feature allows the device to eliminate input offset voltage effects due to power supply and operating temperature variation simply by cycling its power.

Take care to ensure that the power supply settles within 0.4ms of power-up after it crosses a POR threshold of 0.5V to ensure that a stable power supply is present when it steps through its autotrim sequence. If the power supply glitches below the 0.5V threshold, the POR circuitry reactivates during next power-up.

### Shutdown Operation

The MAX9614 features an active-low shutdown mode that puts both inputs and outputs into a high-impedance state. In this mode, the quiescent current is less than  $1\mu\text{A}$ . Putting the output in high-impedance allows multiple signal outputs to be multiplexed onto a single output line without the additional external buffers. The device

does not self-calibrate when exiting shutdown mode, and retains its power-up trim settings. The device also instantly recovers from shutdown.

The shutdown logic levels of the device are independent of supply allowing the shutdown to operate by either a 1.8V or 3.3V microcontroller.

### Interfacing with the MAX11613

The MAX9616 dual amplifier's low power and tiny size is ideal for driving multichannel analog-to-digital converters (ADCs) such as the MAX11613 (see the *Typical Application Circuit*). The MAX11613 is a low-power, 12-bit I<sup>2</sup>C ADC that measures either four single-ended or two differential channels in an 8-pin  $\mu\text{MAX}$  package. Operating from a single 3V or 3.3V supply, the MAX11613 draws a low  $380\mu\text{A}$  supply current when sampling at 10ksps. The MAX11613 family also offers pin-compatible 5V ADCs (MAX11612) and 8-bit (MAX11601) and 10-bit (MAX11607) options.

The MAX9614/MAX9616's output voltage low is designed to be especially close to ground—it is only 11mV above ground, allowing maximum dynamic range in single-supply applications. High output current and capacitance drive capability of the part help it to be useful in ADC driver and line-driver.

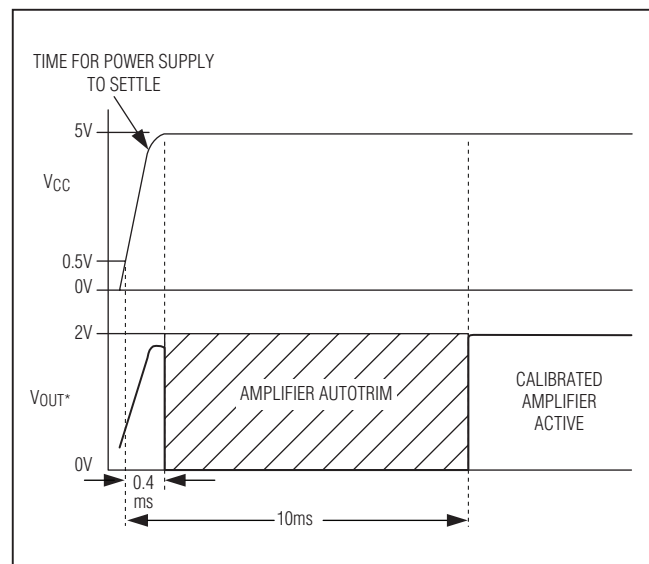

Figure 1. Autotrim Timing Diagram



# Low-Power Single/Dual, Rail-to-Rail Op Amps

## **Input Bias Current**

The MAX9614/MAX9616 feature a high-impedance CMOS input stage and a specialized ESD structure that allows low input bias current operation at low input common-mode voltages. Low input bias current is useful when interfacing with high-ohmic sensors. It is also beneficial for designing transimpedance amplifiers for photodiode sensors. This makes the MAX9614/MAX9616 ideal for ground referenced medical and industrial sensor applications.

## **Active Filters**

The MAX9614/MAX9616 are ideal for a wide variety of active filter circuits that make use of their rail-to-rail output stages and high impedance CMOS inputs. The *Typical Application Circuit* shows an example multiple feedback active filter circuit with a corner frequency of 1.3kHz. At low frequencies, the amplifier behaves like a simple low-distortion inverting amplifier of gain = -1, while its high bandwidth gives excellent stopband attenuation above its corner frequency. See the *Typical Application Circuit*.

## **Chip Information**

PROCESS: BiCMOS

**MAX9614/MAX9616**

# Low-Power Single/Dual, Rail-to-Rail Op Amps

## Package Information

For the latest package outline information and land patterns, go to [www.maxim-ic.com/packages](http://www.maxim-ic.com/packages). Note that a "+", "#", or "-" in the package code indicates RoHS status only. Package drawings may show a different suffix character, but the drawing pertains to the package regardless of RoHS status.

PACKAGE TYPE	PACKAGE CODE	OUTLINE NO.	LAND PATTERN NO.
6 SC70	X6SN-1	<a href="#">21-0077</a>	<a href="#">90-0189</a>
8 SC70	X8SN-1	<a href="#">21-0460</a>	—

COMMON DIMENSIONS			
SYMBOL	MIN	NOM	MAX
A	0.80	0.95	1.10
A1	0.00	0.07	0.10
A2	0.80	0.90	1.00
b	0.15	0.22	0.30
c	0.10	0.14	0.18
D	1.80	2.00	2.20
e	0.65 BSC.		
E	1.15	1.25	1.35
HE	1.80	2.20	2.40
L	0.26	0.34	0.46
L1	0.425 TYP.		
Q1	0.10	0.25	0.40
PKG. CODES	X6SN-1		

NOTES:

- ALL DIMENSIONS ARE IN MILLIMETERS.
- DIMENSIONS ARE INCLUSIVE OF PLATING.
- DIMENSIONS ARE EXCLUSIVE OF MOLD FLASH & METAL BURR.
- COPLANARITY 4 MILS. MAX.
- FOOT LENGTH MEASURED AT INTERCEPT POINT BETWEEN DATUM "A" AND LEAD SURFACE.
- MARKING IS FOR PACKAGE ORIENTATION REFERENCE ONLY.
- LEAD CENTERLINES TO BE AT TRUE POSITION AS DEFINED BY BASIC DIMENSION "e", ±0.05.
- ALL DIMENSIONS COMPLY TO JEDEC MO-203.
- ALL DIMENSIONS APPLY TO BOTH LEADED (-) AND LEAD FREE (+) PACKAGE CODES.

—DRAWING NOT TO SCALE—

<b>MAXIM</b>		
TITLE: PACKAGE OUTLINE, 6L SC70		
APPROVAL	DOCUMENT CONTROL NO. 21-0077	REV. G 1/1

SC70, 6L-EPS

# Low-Power Single/Dual, Rail-to-Rail Op Amps

## Package Information (continued)

For the latest package outline information and land patterns, go to [www.maxim-ic.com/packages](http://www.maxim-ic.com/packages). Note that a "+", "#", or "-" in the package code indicates RoHS status only. Package drawings may show a different suffix character, but the drawing pertains to the package regardless of RoHS status.

MAX9614/MAX9616

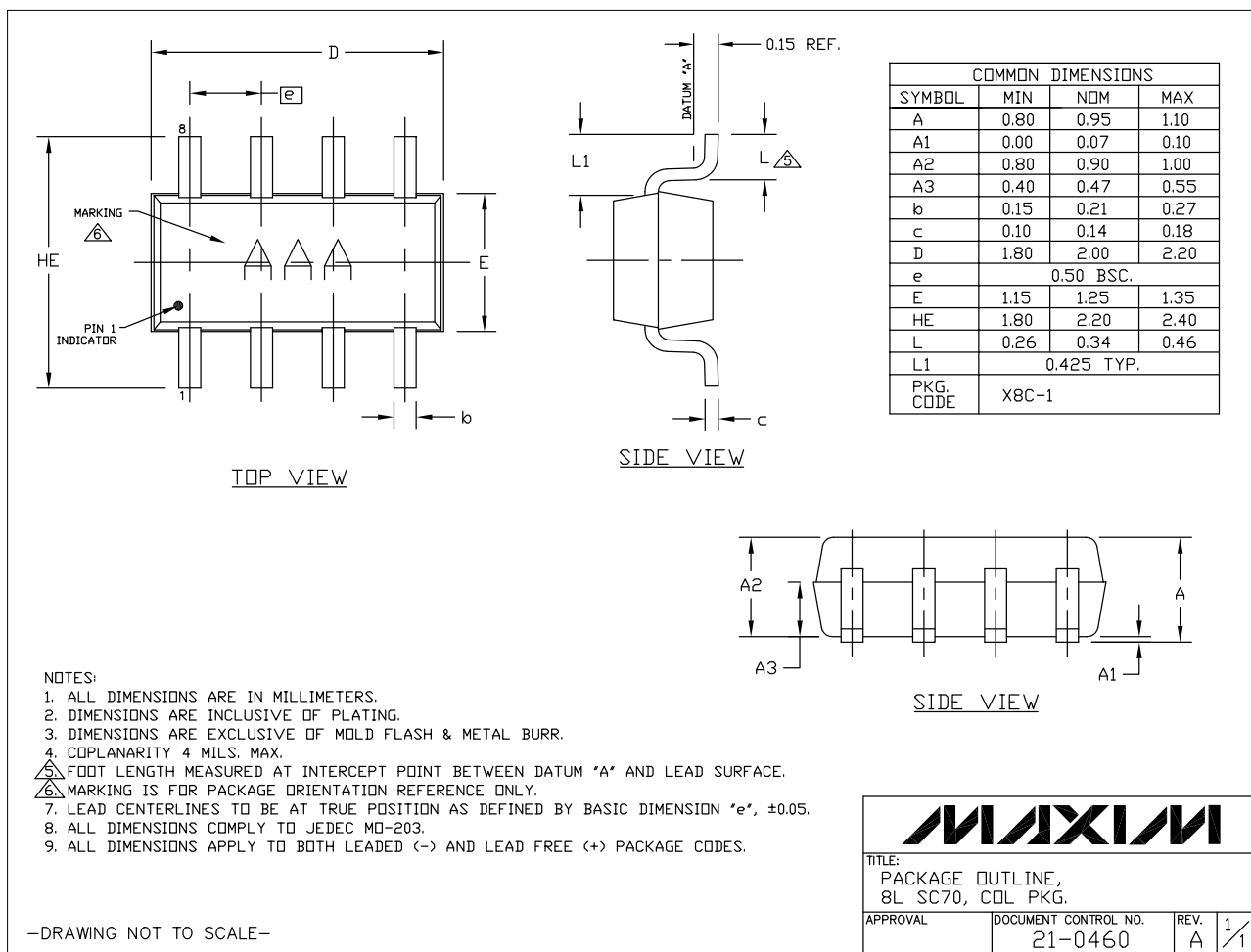

# **Low-Power Single/Dual, Rail-to-Rail Op Amps**

## **Revision History**

<b>REVISION NUMBER</b>	<b>REVISION DATE</b>	<b>DESCRIPTION</b>	<b>PAGES CHANGED</b>
0	8/10	Initial release	—

*Maxim cannot assume responsibility for use of any circuitry other than circuitry entirely embodied in a Maxim product. No circuit patent licenses are implied. Maxim reserves the right to change the circuitry and specifications without notice at any time.*

**12** \_\_\_\_\_ **Maxim Integrated Products, 120 San Gabriel Drive, Sunnyvale, CA 94086 408-737-7600**

## X-ON Electronics

Largest Supplier of Electrical and Electronic Components

*Click to view similar products for [Operational Amplifiers - Op Amps](#) category:*

*Click to view products by [Maxim](#) manufacturer:*

Other Similar products are found below :

[LM258AYDT](#) [LM358SNG](#) [430227FB](#) [UPC824G2-A](#) [LT1678IS8](#) [042225DB](#) [058184EB](#) [UPC259G2-A](#) [NTE925](#) [AZV358MTR-G1](#)  
[AP4310AUMTR-AG1](#) [HA1630D02MMEL-E](#) [HA1630S01LPEL-E](#) [SCY33178DR2G](#) [NJU77806F3-TE1](#) [NCV20034DR2G](#) [LM324EDR2G](#)  
[LM2902EDR2G](#) [NTE7155](#) [NTE778S](#) [NTE871](#) [NTE924](#) [NTE937](#) [MCP6V17T-E/MNY](#) [MCP6V19-E/ST](#) [MCP6V36UT-E/LTY](#)  
[MXD8011HF](#) [MCP6V17T-E/MS](#) [SCY6358ADR2G](#) [LTC2065HUD#PBF](#) [NJM2904CRB1-TE1](#) [2SD965T-R](#) [RS6332P XK](#) [BDM8551](#)  
[BDM321](#) [MD1324](#) [COS8052SR](#) [COS8552SR](#) [COS8554SR](#) [COS2177SR](#) [COS2353SR](#) [COS724TR](#) [ASOPD4580S-R](#) [RS321BKXF](#)  
[ADA4097-1HUIZ-RL7](#) [NCV4333DTBR2G](#) [EL5420CRZ-T7A](#) [AS324MTR-E1](#) [AS358MMTR-G1](#) [MCP6491T-ELTY](#)