

MAX9622

Precision, High-Bandwidth Op Amp

General Description

The MAX9622 op amp features rail-to-rail output and 50MHz GBW at just 1mA supply current. At power-up, this device autocalibrates its input offset voltage to less than 100 μ V. It operates from a single-supply voltage of 2.0V to 5.25V.

The MAX9622 is available in a tiny 2mm x 2mm, 5-pin SC70 package and is rated over the -40°C to +125°C automotive temperature range.

Applications

- Power Modules
- ADC Drivers for Industrial Systems
- Instrumentation
- Filters

Features

- 50MHz UGBW
- Low Input Voltage Offset Voltage (100 μ V max)
- Input Common-Mode Voltage Range Extends Below Ground
- Wide 2.0V to 5.25V Supply Range
- Low 1mA Supply Current

Ordering Information

PART	TEMP RANGE	PIN-PACKAGE	TOP MARK
MAX9622AXK+T	-40°C to +125°C	5 SC70	AUA

+Denotes a lead(Pb)-free/RoHS-compliant package.
T = Tape and reel.

Typical Application Circuit

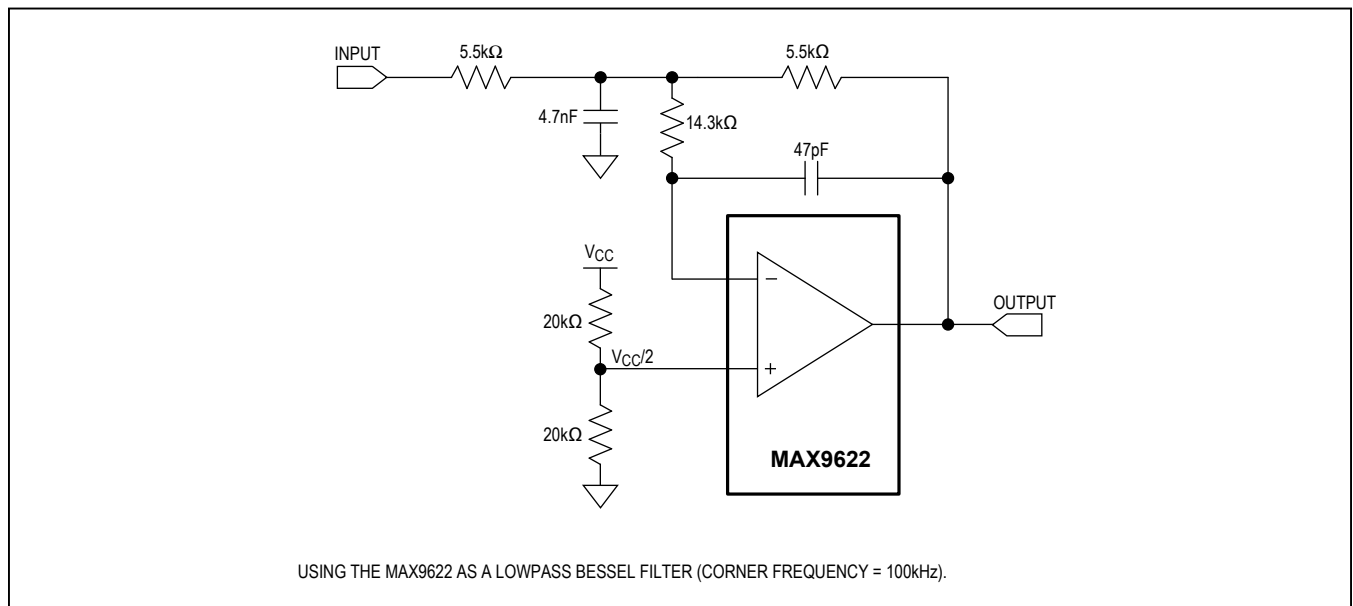

Absolute Maximum Ratings

Supply Voltage (V_{CC} to GND).....-0.3V to +5.5V
 All Other Pins(GND - 0.3V) to (V_{CC} + 0.3V)
 Short-Circuit Duration to GND or V_{CC} 1s
 Continuous Input Current (any pins)..... ±20mA
 Thermal Limits (Note 1)
 Continuous Power Dissipation ($T_A = +70^\circ\text{C}$)
 5-Pin SC70 (derate 3.1mW/°C above +70°C).....245.4mW

Operating Temperature Range..... -40°C to +125°C
 Junction Temperature..... +150°C
 Storage Temperature Range..... -65°C to +150°C
 Lead Temperature (soldering, 10s) +300°C
 Soldering Temperature (reflow)..... +260°C

Note 1: Package thermal resistances were obtained using the method described in JEDEC specification JESD51-7, using a four-layer board. For detailed information on package thermal considerations, refer to www.maximintegrated.com/thermal-tutorial.

Stresses beyond those listed under "Absolute Maximum Ratings" may cause permanent damage to the device. These are stress ratings only, and functional operation of the device at these or any other conditions beyond those indicated in the operational sections of the specifications is not implied. Exposure to absolute maximum rating conditions for extended periods may affect device reliability.

Electrical Characteristics

($V_{CC} = 5\text{V}$, $V_{IN+} = V_{IN-} = 0\text{V}$, $R_L = 10\text{k}\Omega$ to $V_{CC}/2$, $T_A = -40^\circ\text{C}$ to $+125^\circ\text{C}$, unless otherwise noted. Typical values are at $T_A = +25^\circ\text{C}$.)
 (Note 2)

PARAMETER	SYMBOL	CONDITIONS	MIN	TYP	MAX	UNITS	
POWER SUPPLY							
Supply Voltage Range	V_{CC}	Guaranteed by PSRR	2		5.25	V	
Supply Current	I_{CC}	No load	$T_A = +25^\circ\text{C}$		1.5	mA	
			$-40^\circ\text{C} \leq T_A \leq +125^\circ\text{C}$		2.1		
Power-Supply Rejection Ratio	PSRR	$T_A = +25^\circ\text{C}$		97	126	dB	
		$-40^\circ\text{C} \leq T_A \leq +125^\circ\text{C}$		93			
Power-Up Time	t_{ON}			3		ms	
DC SPECIFICATIONS							
Input Offset Voltage	V_{OS}	After power-up autocalibration		8	100	μV	
		$-40^\circ\text{C} \leq T_A \leq +125^\circ\text{C}$		8	3000		
Input Offset Voltage Drift	ΔV_{OS}			3		$\mu\text{V}/^\circ\text{C}$	
Input Bias Current	I_B	$T_A = +25^\circ\text{C}$		62	150	nA	
		$-40^\circ\text{C} \leq T_A \leq +125^\circ\text{C}$			320		
Input Offset Current	I_{OS}	$T_A = +25^\circ\text{C}$		3	12	nA	
		$-40^\circ\text{C} \leq T_A \leq +125^\circ\text{C}$			30		
Input Common-Mode Range	V_{CM}	Guaranteed by CMRR, $T_A = -40^\circ\text{C}$ to $+125^\circ\text{C}$		-0.1	$V_{CC} - 1.3$	V	
Common-Mode Rejection Ratio	CMRR	$T_A = +25^\circ\text{C}$		87	121	dB	
		$-40^\circ\text{C} \leq T_A \leq +125^\circ\text{C}$		80			
Large-Signal Gain	A_{VOL}	$400\text{mV} \leq V_{OUT} \leq V_{CC} - 400\text{mV}$	$T_A = +25^\circ\text{C}$		91	103	dB
			$-40^\circ\text{C} \leq T_A \leq +125^\circ\text{C}$		84		
		$400\text{mV} \leq V_{OUT} \leq V_{CC} - 400\text{mV}$, $R_L = 1\text{k}\Omega$ to $V_{CC}/2$	$T_A = +25^\circ\text{C}$		77	89	
			$-40^\circ\text{C} \leq T_A \leq +125^\circ\text{C}$		69		
Output Voltage Swing	$V_{OH} - V_{CC}$	$R_L = 10\text{k}\Omega$ to $V_{CC}/2$			60	mV	
		$R_L = 10\text{k}\Omega$ to $V_{CC}/2$			60		
	V_{OL}	$R_L = 10\text{k}\Omega$ to GND, $T_A = +25^\circ\text{C}$			40		
		$R_L = 10\text{k}\Omega$ to GND			48		
Short-Circuit Current	I_{SC}	(Note 3)		80		mA	

Electrical Characteristics (continued)

($V_{CC} = 5V$, $V_{IN+} = V_{IN-} = 0V$, $R_L = 10k\Omega$ to $V_{CC}/2$, $T_A = -40^\circ C$ to $+125^\circ C$, unless otherwise noted. Typical values are at $T_A = +25^\circ C$.) (Note 2)

PARAMETER	SYMBOL	CONDITIONS	MIN	TYP	MAX	UNITS
AC SPECIFICATIONS						
Gain-Bandwidth Product	GBW			50		MHz
Large-Signal Bandwidth	BW_{LS}	$V_{OUT} = 2V_{P-P}$		3		MHz
Slew Rate	SR	$V_{OUT} = 2V_{P-P}$, 10% to 90%		20		V/ μs
Settling Time	t_S	To 0.1%, $V_{OUT} = 2V_{P-P}$, $C_L = 10pF$		200		ns
Total Harmonic Distortion	THD	$f = 10kHz$, $V_{OUT} = 2V_{P-P}$		90		dB
Input Voltage-Noise Density	e_N	$f = 10kHz$		13		nV/ \sqrt{Hz}
Input Current-Noise Density	i_N	$f = 10kHz$		3		pA/ \sqrt{Hz}

Note 2: The device is 100% production tested at $T_A = +25^\circ C$. Temperature limits are guaranteed by design.

Note 3: Guaranteed by design.

Typical Operating Characteristics

($V_{CC} = 5V$, $R_L = 10k\Omega$ to $V_{CC}/2$, $T_A = +25^\circ C$, unless otherwise noted.)

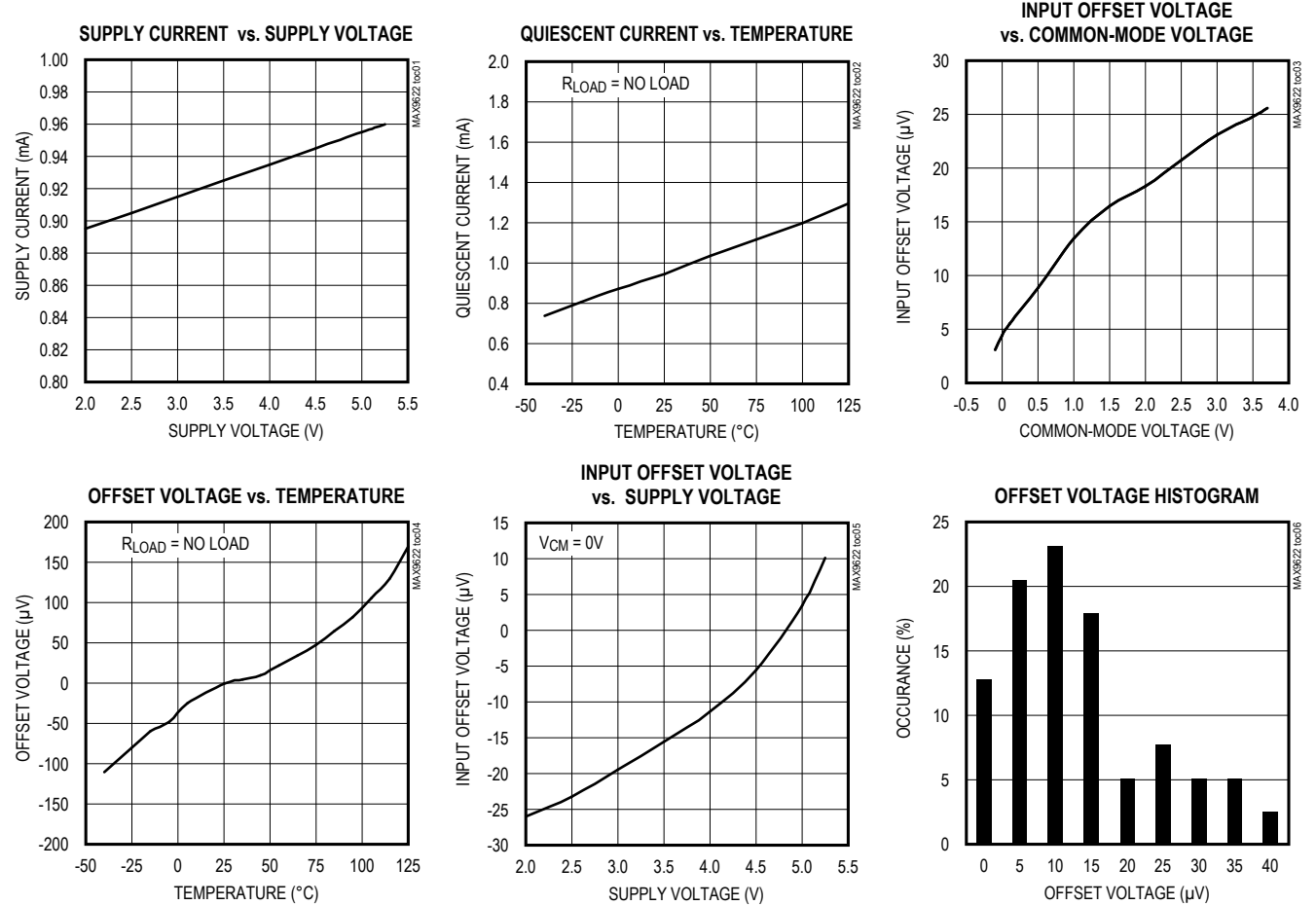

Typical Operating Characteristics (continued)

($V_{CC} = 5V$, $R_L = 10k\Omega$ to $V_{CC}/2$, $T_A = +25^\circ C$, unless otherwise noted.)

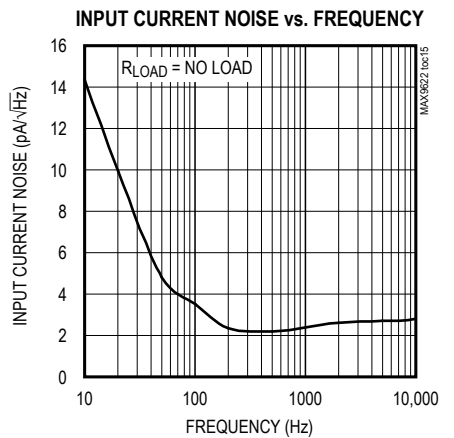
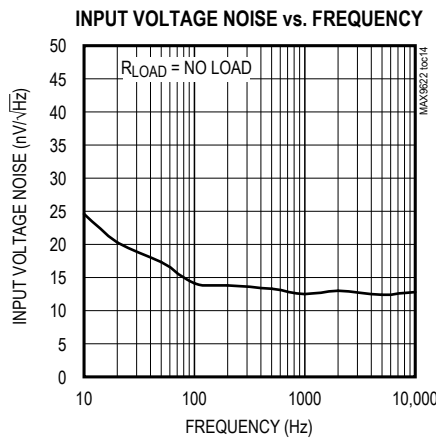
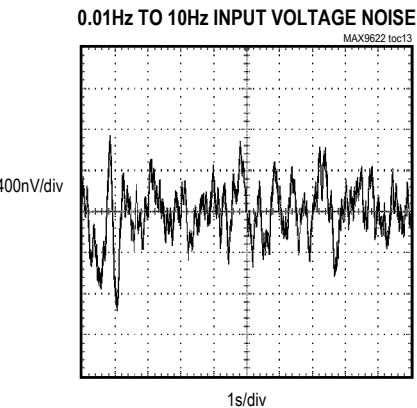
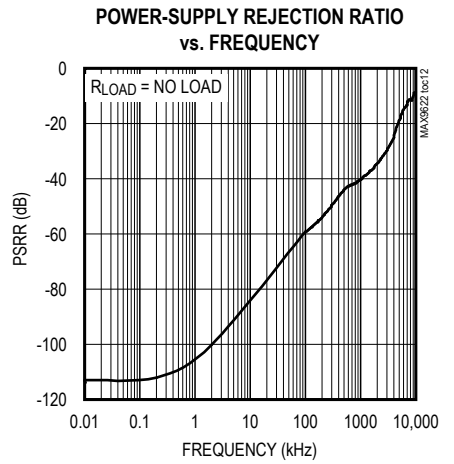
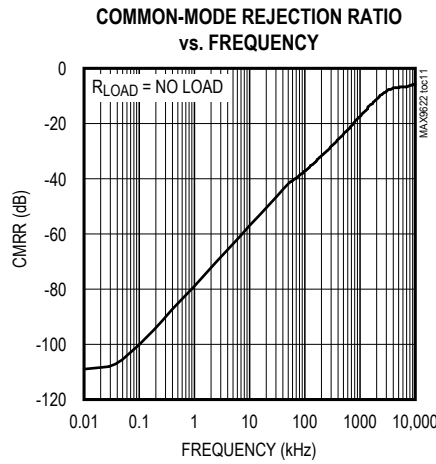
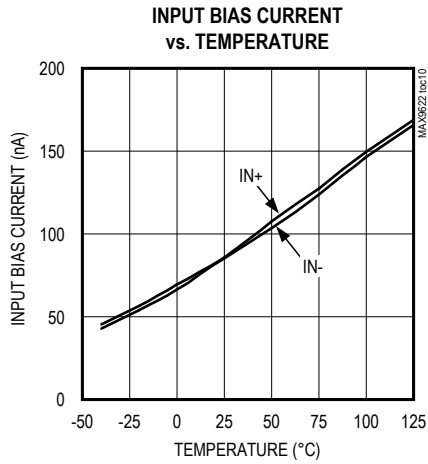
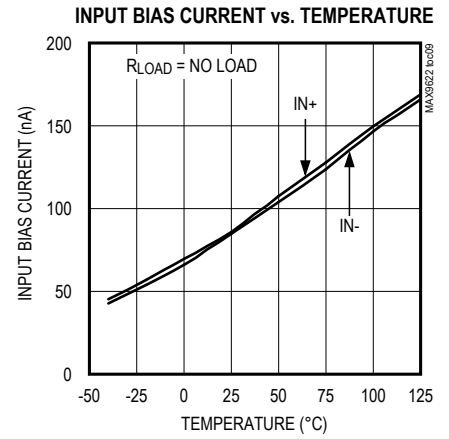
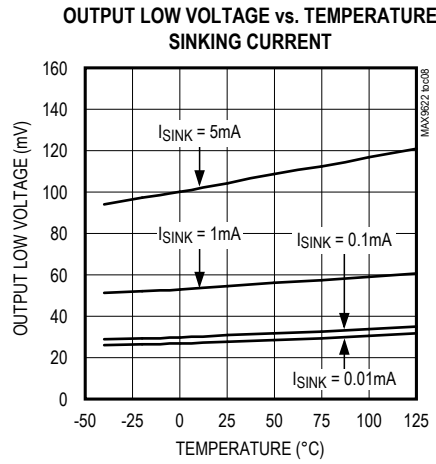
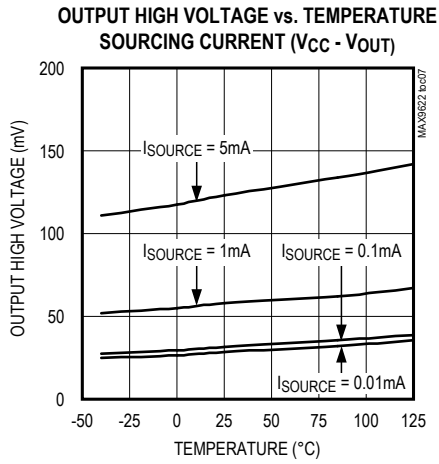

Typical Operating Characteristics (continued)

($V_{CC} = 5V$, $R_L = 10k\Omega$ to $V_{CC}/2$, $T_A = +25^\circ C$, unless otherwise noted.)

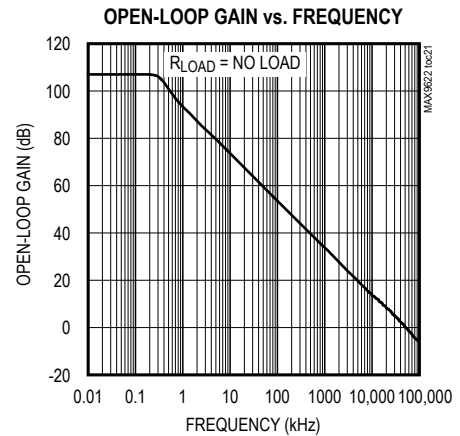
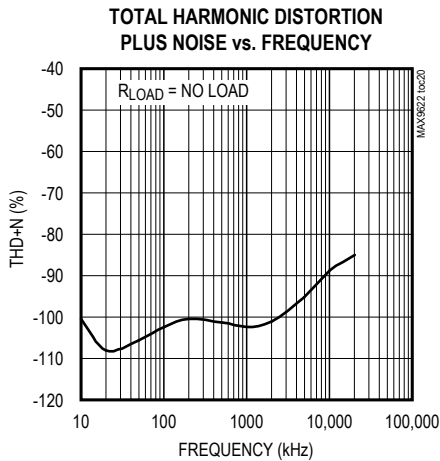
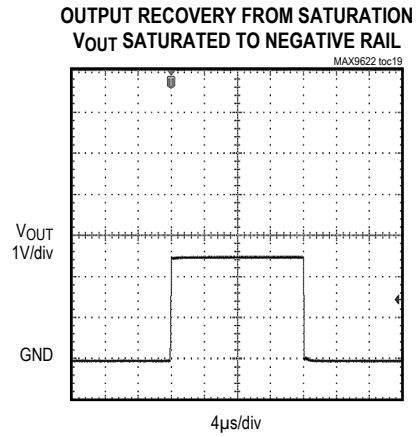
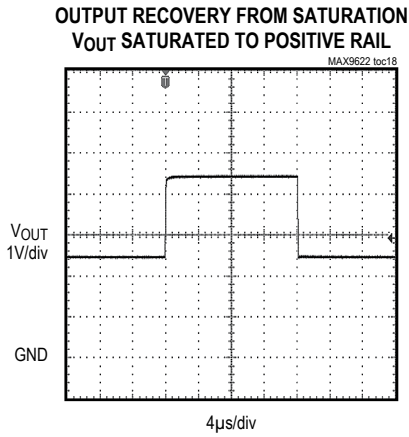
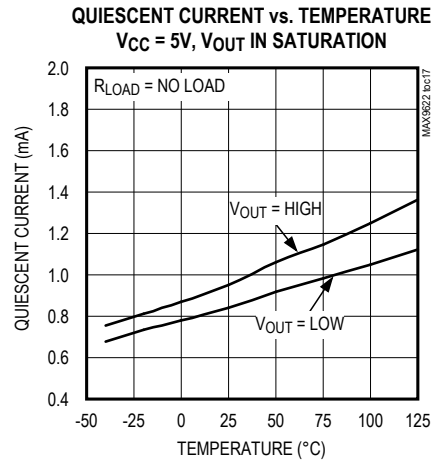
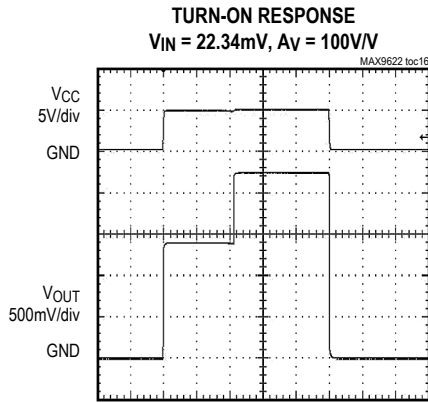

Typical Operating Characteristics (continued)

($V_{CC} = 5V$, $R_L = 10k\Omega$ to $V_{CC}/2$, $T_A = +25^\circ C$, unless otherwise noted.)

LARGE-SIGNAL RESPONSE

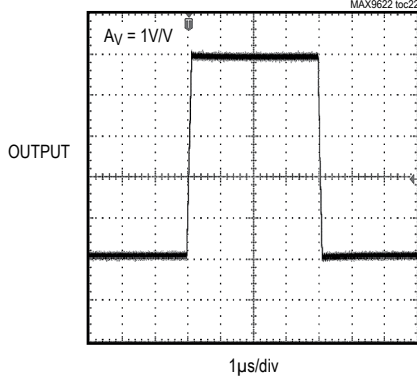

SMALL-SIGNAL RESPONSE

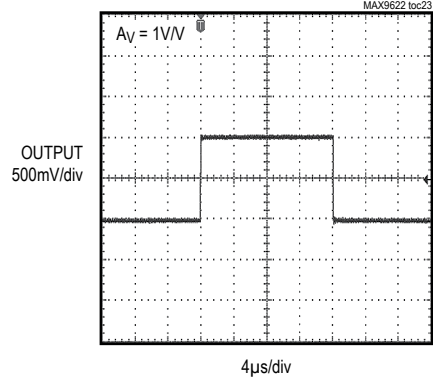

CAPACITIVE LOADING STABILITY vs. ISOLATION RESISTANCE, $A_V = 1V/V$

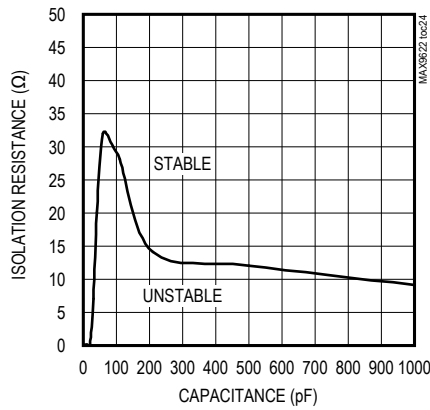

PARALLEL CAPACITIVE LOADING

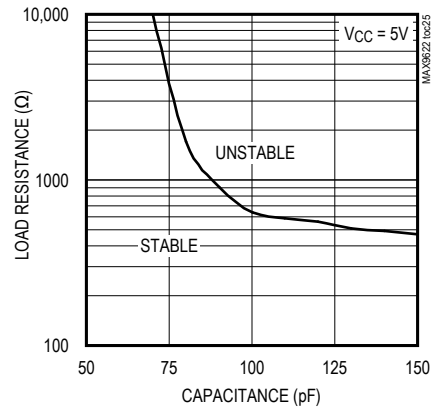

CROSSTALK vs. FREQUENCY

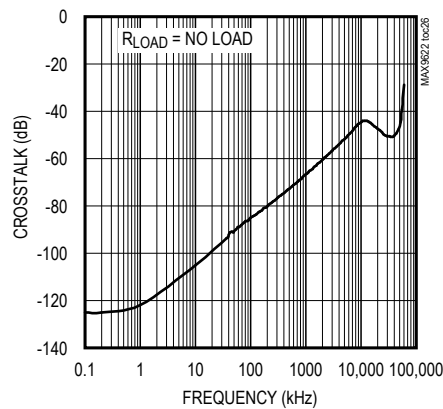

Pin Configuration

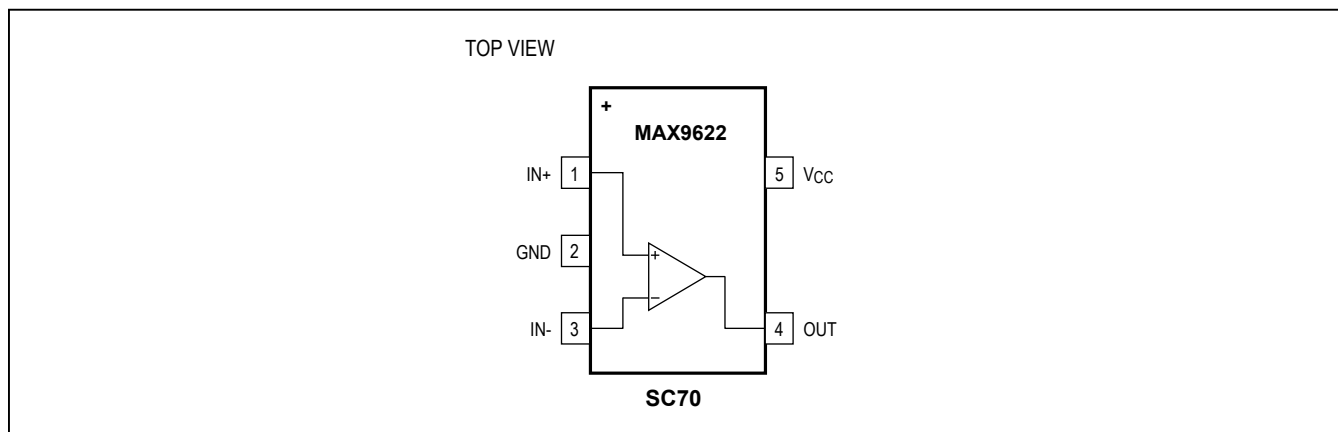

Pin Description

PIN	NAME	FUNCTION
1	IN+	Positive Input
2	GND	Ground
3	IN-	Negative Input
4	OUT	Output
5	V _{CC}	Positive Power Supply. Bypass with a 0.1μF capacitor to ground.

Detailed Description

The MAX9622 is a power-efficient, high-speed op amp ideal for capturing fast edges in a wide variety of signal processing applications.

It precisely calibrates its V_{OS} on power-up to eliminate the effects of package stresses, power supplies, and temperature.

Applications Information

Power-Up Autotrim

The MAX9622 features power-up autotrimming that allows the devices to achieve less than $100\mu V$ of input offset voltage. The startup sequence takes approximately 4ms to complete after the supply voltage exceeds an internal threshold of 1.8V. During this time, the inputs and outputs are connected to an auxiliary amplifier that has an input offset of 5mV (typ). As soon as the autotrimming is completed, the inputs and outputs switch from the auxiliary amplifier to the calibrated amplifier. The calibration settings hold until the supply voltage drops below an internal threshold of 1.4V. This could be used to recalibrate the amplifier. The supply current of the part increases to about 2.5mA during the power-up autotrim period. Use good supply decoupling with low ESR capacitors.

Active Filters

The MAX9622 is ideal for a wide variety of active filter circuits that make use of their wide output voltage swings and large bandwidth capabilities. The *Typical Application Circuit* shows a multiple feedback active filter circuit example with a 100kHz corner frequency. At low frequencies, the amplifier behaves like a simple low-distortion inverting amplifier gain = -1, while its high bandwidth gives excellent stopband attenuation above its corner frequency. See the *Typical Application Circuit*.

Input Differential Voltage Protection

During normal op-amp operation, the inverting and non-inverting inputs of the MAX9622 are at essentially the same voltage. However, either due to fast input voltage transients or due to loss of negative feedback, these pins can be forced to different voltages. Internal back-to-back diodes and series resistors protect input-stage transistors from large input differential voltages (see Figure 2). IN+ and IN- can survive any voltage between the power-supply rails.

This op amp has been designed to exhibit no phase inversion to overdriven inputs.

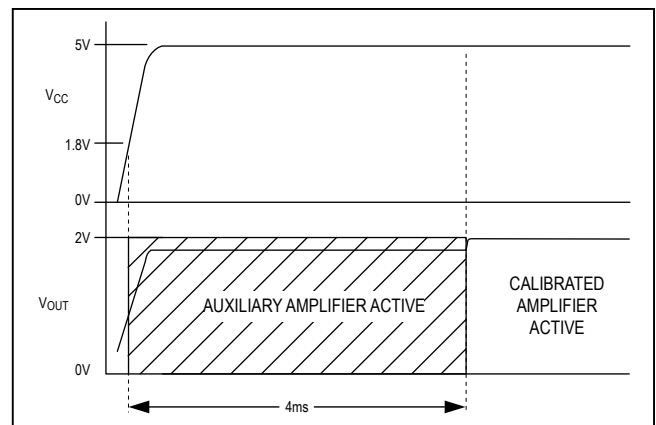

Figure 1. Autotrim Timing Diagram

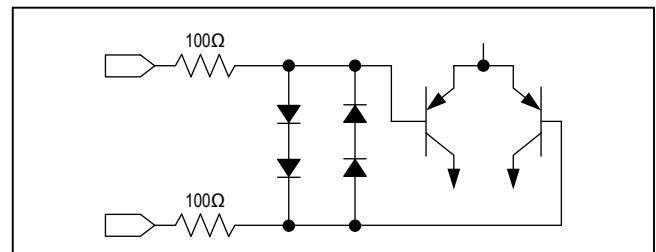

Figure 2. Input Protection Circuit

Package Information

For the latest package outline information and land patterns (footprints), go to www.maximintegrated.com/packages. Note that a "+", "#", or "-" in the package code indicates RoHS status only. Package drawings may show a different suffix character, but the drawing pertains to the package regardless of RoHS status.

PACKAGE TYPE	PACKAGE CODE	OUTLINE NO.	LAND PATTERN NO.
5 SC70	X5+1	21-0076	90-0188

Revision History

REVISION NUMBER	REVISION DATE	DESCRIPTION	PAGES CHANGED
0	9/10	Initial release	—
1	4/15	Removed automotive reference from data sheet	1

For pricing, delivery, and ordering information, please contact Maxim Direct at 1-888-629-4642, or visit Maxim Integrated's website at www.maximintegrated.com.

Maxim Integrated cannot assume responsibility for use of any circuitry other than circuitry entirely embodied in a Maxim Integrated product. No circuit patent licenses are implied. Maxim Integrated reserves the right to change the circuitry and specifications without notice at any time. The parametric values (min and max limits) shown in the Electrical Characteristics table are guaranteed. Other parametric values quoted in this data sheet are provided for guidance.

X-ON Electronics

Largest Supplier of Electrical and Electronic Components

Click to view similar products for [Precision Amplifiers](#) category:

Click to view products by [Maxim](#) manufacturer:

Other Similar products are found below :

[561681F](#) [LT6005HGN#PBF](#) [LT6238CGN#PBF](#) [LT6238HGN#PBF](#) [OP05CN8#PBF](#) [OP227GN#PBF](#) [LT6020IDD#PBF](#) [LT6020IDD-1#PBF](#)
[LT1124CS8#TR](#) [NCS21802MUTBG](#) [LT1637MPS8](#) [LT1498IS8](#) [LT1492CS8](#) [TLC27L7CP](#) [TLV2473CDR](#) [LMP2234AMA/NOPB](#)
[LMP7707MA/NOPB](#) [5962-8859301M2A](#) [LMP2231AMAE/NOPB](#) [LMP2234AMTE/NOPB](#) [LMP8672MA/NOPB](#) [LMC6022IM/NOPB](#)
[LMC6024IM/NOPB](#) [LMC6081IMX/NOPB](#) [LMP2011MA/NOPB](#) [LMP2231AMFE/NOPB](#) [LMP2232BMA/NOPB](#) [LMP2234AMAE/NOPB](#)
[LMP7715MFE/NOPB](#) [LMP7717MAE/NOPB](#) [LMV2011MA/NOPB](#) [TL034ACDR](#) [TLC2201AMDG4](#) [TLE2024BMDWG4](#)
[TLV2474AQDRG4Q1](#) [TLV2472QDRQ1](#) [TLC4502IDR](#) [TLC27M2ACP](#) [TLC2652Q-8DG4](#) [OPA2107APG4](#) [TL054AIDR](#) [AD8619WARZ-](#)
[R7](#) [TLC272CD](#) [AD8539ARMZ](#) [LTC6084HDD#PBF](#) [LTC1050CN8#PBF](#) [LT1024CN#PBF](#) [LT1996AIDD#PBF](#) [LTC2055CDD#PBF](#)
[LTC1152CS8#PBF](#)