

MAX9643

60V High-Speed Precision Current-Sense Amplifier

General Description

The MAX9643 is a high-speed 60V precision unidirectional current-sense amplifier ideal for a wide variety of power-supply control applications. Its high signal bandwidth allows its use within DC-DC switching converter power-supply control loops with minimal phase delay.

The IC also features 130 μ V (max) precision input offset voltage, allowing small sense resistors to be used in applications where efficiency is important and when wide dynamic-range current measurement is needed.

High DC CMRR and AC CMRR make it easy to use in a wide variety of aggressive environments. The device is available in fixed gains of 2.5V/V and 10V/V. It is also available in a small, 8-pin TDFN (2mm x 3mm) package and is rated over the -40°C to +125°C temperature range.

Applications

- Industrial Power Supplies
- GSM Base Station Power Supply
- High-Brightness LED Control
- H-Bridge Motor Control

Benefits and Features

- Supports High-Voltage Applications
 - Wide Input V_{CM} = -1.5V to +60V
- Delivers High-Speed Operation
 - 15MHz Bandwidth
- Increases System Accuracy
 - Precision V_{OS} = 130 μ V (max)
- -40°C to +125°C Specified Temperature Range

Ordering Information appears at end of data sheet.

For related parts and recommended products to use with this part, refer to www.maximintegrated.com/MAX9643.related.

Typical Operating Circuit

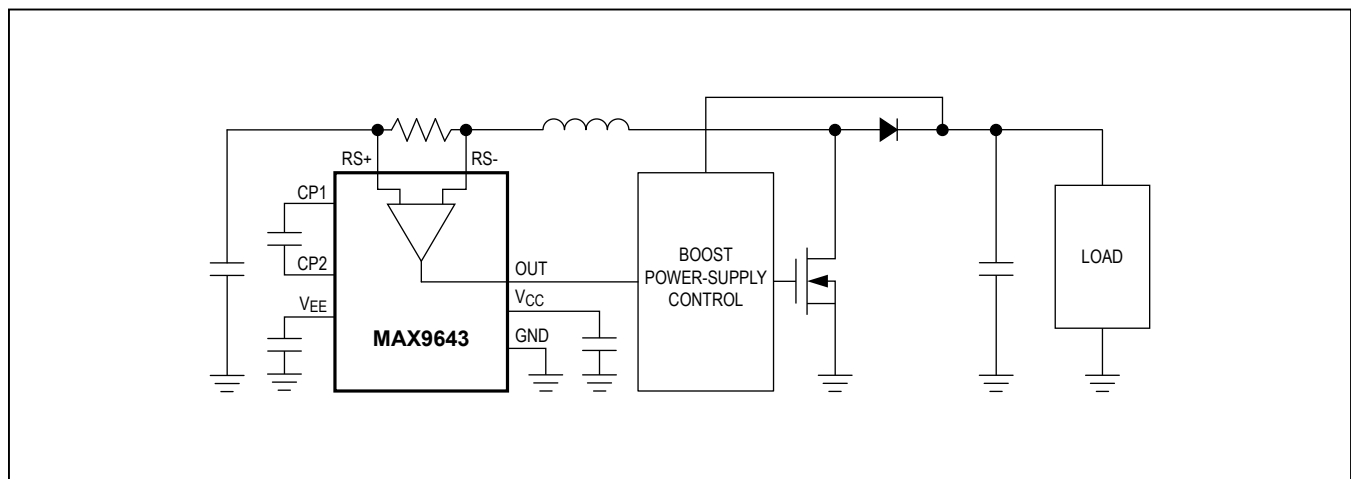

Absolute Maximum Ratings

| | | | |
|--------------------------------------|------------------------------------|--|-----------------------------------|
| RS+ to GND, RS- to GND (Note 1)..... | -3.5V to +65V | CP2 to GND | (V _{EE} - 0.3V) to +0.3V |
| RS+ to RS-..... | ±15V | Short-Circuit Duration..... | Continuous |
| V _{CC} to GND..... | -0.3V to +40V | Continuous Input Current into Any Pin..... | ±20mA |
| V_{CC} > 4.5V | | ESD on RS+, RS-..... | ±4kV HBM |
| OUT to GND..... | -0.3V to +4.5V | ESD on All Other Pins..... | ±2kV HBM |
| V _{EE} to GND..... | +0.3V to -5V | Maximum Power Dissipation | |
| CP1 to GND..... | -0.3V to +4.5V | TDFN-EP (derate 16.7mW/°C at +70°C)..... | 1333.3mW |
| V_{CC} ≤ 4.5V | | Operating Temperature Range..... | -40°C to +125°C |
| OUT to GND..... | -0.3V to (V _{CC} + 0.3V) | Junction Temperature..... | +150°C |
| V _{EE} to GND..... | +0.3V to (-V _{CC} + 0.3V) | Lead Temperature (10s, soldering)..... | +300°C |
| CP1 to GND..... | -0.3V to (V _{CC} + 0.3V) | Soldering Temperature (reflow)..... | +260°C |

Note 1: Voltages below -3.5V are allowed, as long as the input current is limited to 5mA by an external resistor.

Stresses beyond those listed under "Absolute Maximum Ratings" may cause permanent damage to the device. These are stress ratings only, and functional operation of the device at these or any other conditions beyond those indicated in the operational sections of the specifications is not implied. Exposure to absolute maximum rating conditions for extended periods may affect device reliability.

Package Thermal Characteristics (Note 2)

TDFN

| | |
|--|--------|
| Junction-to-Ambient Thermal Resistance (θ _{JA})..... | 60°C/W |
| Junction-to-Case Thermal Resistance (θ _{JC})..... | 11°C/W |

Note 2: Package thermal resistances were obtained using the method described in JEDEC specification JESD51-7, using a four-layer board. For detailed information on package thermal considerations, refer to www.maximintegrated.com/thermal-tutorial.

Electrical Characteristics

(V_{CC} = 5V, V_{RS+} = V_{RS-} = 12V, T_A = -40°C to +125°C, unless otherwise noted.) (Note 3)

| PARAMETER | SYMBOL | CONDITIONS | MIN | TYP | MAX | UNITS |
|---|-------------------------------------|---|-----------------------|------|------|-------|
| DC CHARACTERISTICS | | | | | | |
| Input Common-Mode Voltage Range | V _{RS+} , V _{RS-} | V _{CC} ≥ 5V, guaranteed by CMRR test, V _{SENSE} ≤ 100mV | -1.5 | | +60 | V |
| | | V _{CC} < 5V, guaranteed by CMRR test, V _{SENSE} ≤ 100mV | 3.5 - V _{CC} | | 60 | |
| Input Offset Voltage (Notes 4, 5) | V _{OS} | T _A = +25°C | | 10 | 130 | µV |
| | | -40°C < T _A < +125°C | | | 650 | |
| | | +10°C < T _A < +85°C | | | 400 | |
| Common-Mode Rejection Ratio (Note 5) | CMRR | -1.5V ≤ V _{CM} ≤ 60V, T _A = +25°C | 120 | 130 | | dB |
| | | -1.5V ≤ V _{CM} ≤ 60V, -40°C ≤ T _A ≤ +125°C | 110 | | | |
| CMRR vs. Frequency (Note 5) | AC CMRR | f = 100kHz | | 90 | | dB |
| Input Bias Current | I _{RS+} , I _{RS-} | T _A = +25°C | | 35 | 60 | µA |
| | | -40°C < T _A < +125°C | | | 60 | |
| Input Bias Current, V _{CC} = 0V, V _{RS+} = V _{RS-} = 60V | I _{RS+} , I _{RS-} | | | | 25 | µA |
| Input Offset Current (Note 6) | I _{RS+} - I _{RS-} | T _A = +25°C | | 0.02 | 0.65 | µA |
| | | +10°C < T _A < +85°C | | | 0.65 | |
| | | -40°C < T _A < +125°C | | | 0.8 | |

Electrical Characteristics* (continued)(V_{CC} = 5V, V_{RS+} = V_{RS-} = 12V, T_A = -40°C to +125°C, unless otherwise noted.) (Note 3)

| PARAMETER | SYMBOL | CONDITIONS | MIN | TYP | MAX | UNITS |
|---|-----------------|---|-----------------------|-----|------|-------|
| Maximum Sense Voltage Before Input Saturation | FS | V _{CM} < 2V | 100 | | mV | |
| | | V _{CM} ≥ 2V | MAX9643T | 400 | | |
| | | | MAX9643U | 300 | | |
| Voltage Gain (Note 4) | | MAX9643T | 2.5 | | V/V | |
| | | MAX9643U | 10 | | | |
| Voltage Gain Error (Note 4) | GE | T _A = +25°C | 0.06 | 0.5 | % | |
| | | -40°C < T _A < +125°C | 0.6 | | | |
| AC CHARACTERISTICS | | | | | | |
| Signal Bandwidth | BW | V _{SENSE} = 25mV _{DC} + 2mV _{P-P} , MAX9643T | 15 | | MHz | |
| | | V _{SENSE} = 25mV _{DC} + 2mV _{P-P} , MAX9643U | 10 | | | |
| Slew Rate | SR | V _{OUT} = 10mV to 110mV | 12 | | V/μs | |
| Delay from Output Saturation to V _{OL} | | V _{SENSE} = 0 to 20mV | 100 | | ns | |
| Delay from Input Saturation and Delay from Output Saturation to V _{OH} | | V _{SENSE} = 10V to 10mV | 1 | | μs | |
| OUTPUT CHARACTERISTICS | | | | | | |
| Output Short-Circuit Current | I _{SC} | | 3.39 | | mA | |
| Output-Voltage Low (MAX9643T) (Note 5) | V _{OL} | I _{OUT} = 100μA sink, T _A = +25°C | 0.2 | 1 | mV | |
| | | I _{OUT} = 100μA sink, -40°C < T _A < +125°C | 2.2 | | | |
| | | I _{OUT} = 100μA sink, +10°C < T _A < +85°C | 1.2 | | | |
| | | I _{OUT} = 1mA sink, T _A = +25°C | 0.6 | 10 | | |
| | | I _{OUT} = 1mA sink, -40°C < T _A < +125°C | 10 | | | |
| Output-Voltage Low (MAX9643U) (Note 5) | V _{OL} | I _{OUT} = 100μA sink, T _A = +25°C | 0.5 | 4 | mV | |
| | | I _{OUT} = 100μA sink, -40°C < T _A < +125°C | 8.8 | | | |
| | | I _{OUT} = 100μA sink, +10°C < T _A < +85°C | 4.8 | | | |
| | | I _{OUT} = 1mA sink, T _A = +25°C | 0.6 | 10 | | |
| | | I _{OUT} = 1mA sink, -40°C < T _A < +125°C | 10 | | | |
| Output-Voltage High (Note 7) | V _{OH} | I _{OUT} = 1mA source, V _{CC} < 4.5V | V _{CC} - 1.3 | | V | |
| | | I _{OUT} = 1mA source, V _{CC} ≥ 4.5V | 3.2 | | | |
| Capacitive Drive Capability | CL | R _{LOAD} = Open, no sustained oscillation | 30 | | pF | |

Electrical Characteristics* (continued)(V_{CC} = 5V, V_{RS+} = V_{RS-} = 12V, T_A = -40°C to +125°C, unless otherwise noted.) (Note 3)

| PARAMETER | SYMBOL | CONDITIONS | MIN | TYP | MAX | UNITS |
|--|-----------------|---|-----|------|------|-------|
| POWER-SUPPLY CHARACTERISTICS | | | | | | |
| Power Supply | V _{CC} | Guaranteed by PSRR | 2.7 | | 36 | V |
| Power-Supply Rejection Ratio (Note 5) | PSRR | V _{CC} = 2.7V to 36V, V _{SENSE} = 10mV, T _A = +25°C | 107 | 125 | | dB |
| | | -40°C < T _A < +125°C | 100 | | | |
| Quiescent Supply Current | I _{CC} | T _A = +25°C | | 1000 | 1400 | μA |
| | | -40°C < T _A < +125°C | | | 1600 | |
| Charge-Pump Current | I _{EE} | ΔV _{EE} = 500mV | | 4 | | mA |

Note 3: All devices are 100% production tested at T_A = +25°C. Temperature limits are guaranteed by design and/or characterization.**Note 4:** Gain and offset voltage are calculated based on two point measurements: V_{SENSE1} = 10mV and V_{SENSE2} = 100mV.**Note 5:** V_{OS}, V_{OL}, CMRR, and PSRR are measured with the charge pump off.**Note 6:** Guaranteed by design and/or characterization.**Note 7:** The maximum V_{SENSE} of the MAX9643T is 400mV. With the gain = 2.5V/V, the output swing high is not applicable to the MAX9643T.

Typical Operating Characteristics

($V_{CC} = 5V$, $V_{RS+} = V_{RS-} = 12V$, $T_A = -40^{\circ}C$ to $+125^{\circ}C$, unless otherwise noted. All devices are 100% production tested at $T_A = +25^{\circ}C$. Temperature limits are guaranteed by design and/or characterization.)

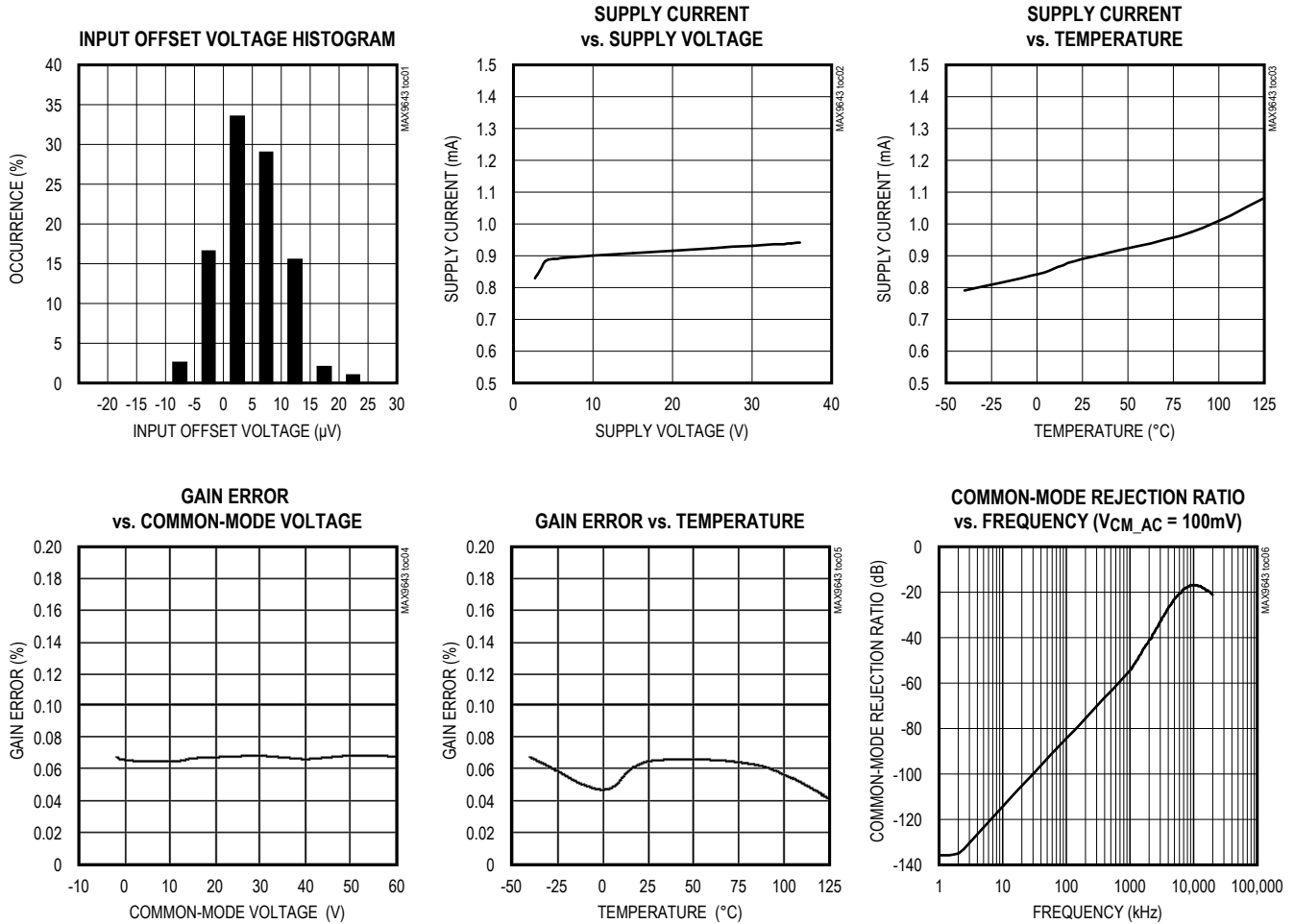

Typical Operating Characteristics (continued)

($V_{CC} = 5V$, $V_{RS+} = V_{RS-} = 12V$, $T_A = -40^{\circ}C$ to $+125^{\circ}C$, unless otherwise noted. All devices are 100% production tested at $T_A = +25^{\circ}C$. Temperature limits are guaranteed by design and/or characterization.)

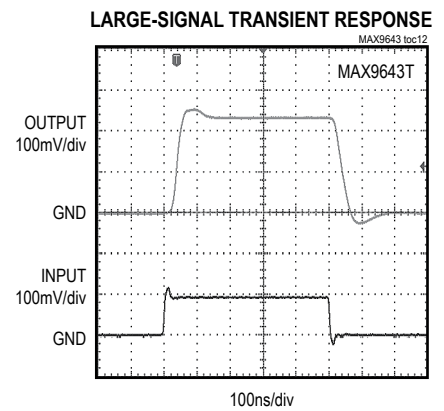
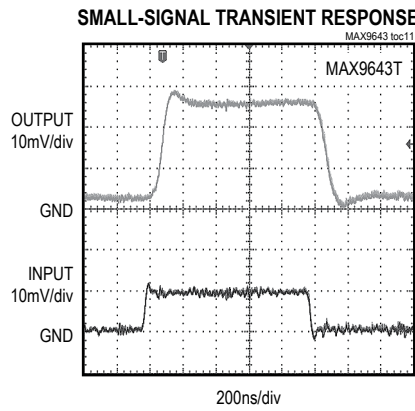
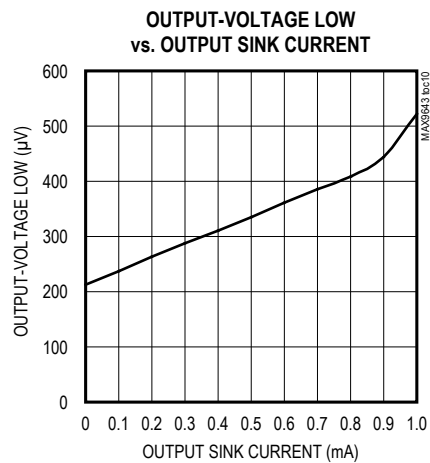
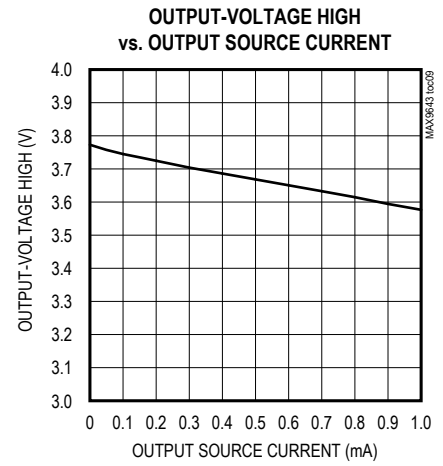
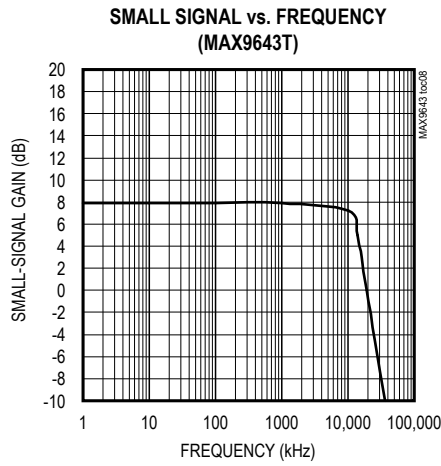
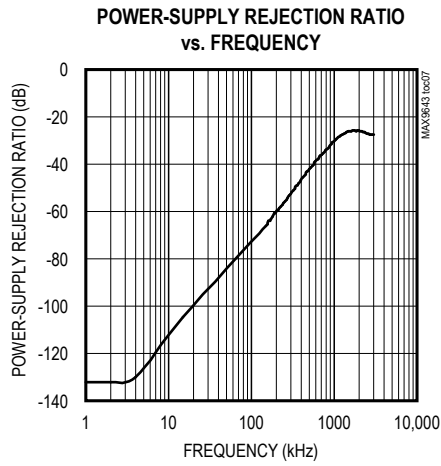

Typical Operating Characteristics (continued)

($V_{CC} = 5V$, $V_{RS+} = V_{RS-} = 12V$, $T_A = -40^{\circ}C$ to $+125^{\circ}C$, unless otherwise noted. All devices are 100% production tested at $T_A = +25^{\circ}C$. Temperature limits are guaranteed by design and/or characterization.)

OUTPUT HIGH-SATURATION RECOVERY RESPONSE (INPUT SIGNAL = 4V TO 100mV)

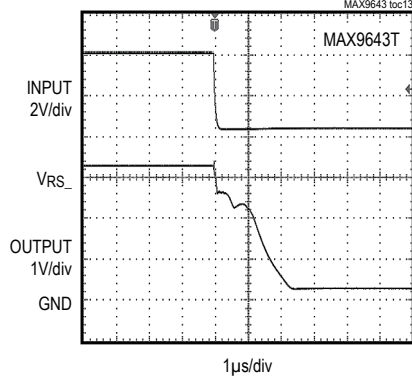

OUTPUT LOW-SATURATION RECOVERY RESPONSE (INPUT SIGNAL = 0V TO 20mV)

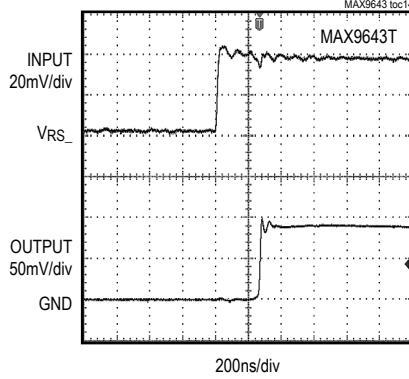

STARTUP DELAY (VSENSE = 200mV)

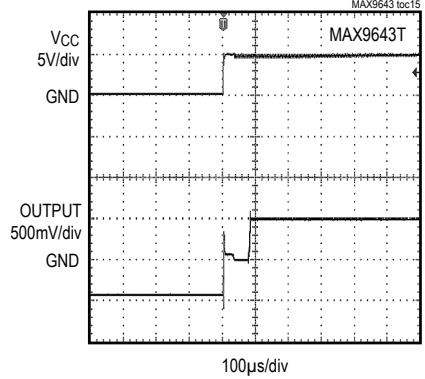

INPUT SENSE VOLTAGE SATURATION ($V_{CM} = 12V$)

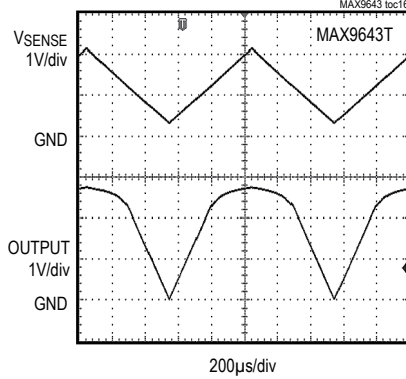

INPUT SENSE VOLTAGE SATURATION ($V_{CM} = 1.5V$)

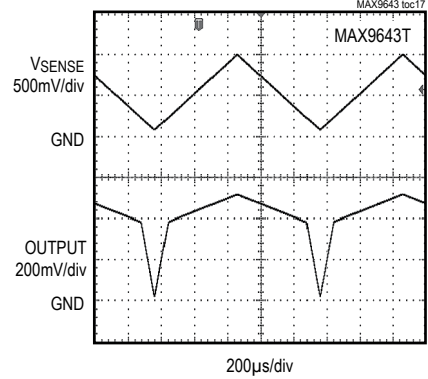

CHARGE-PUMP NOISE

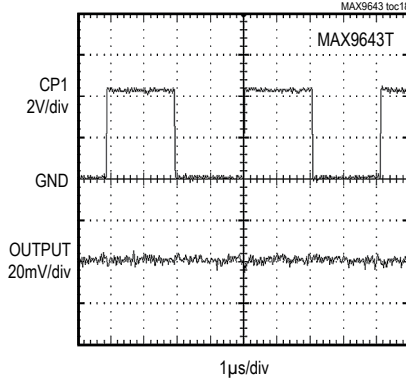

COMMON MODE ($V_{CM} = 0V$ TO $10V$)

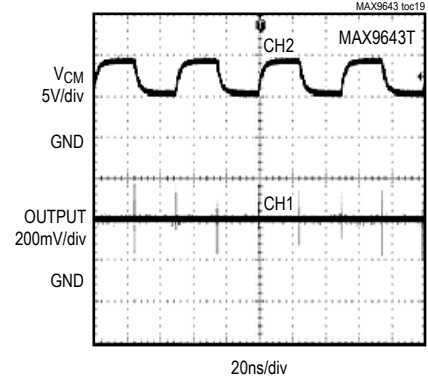

Pin Configuration

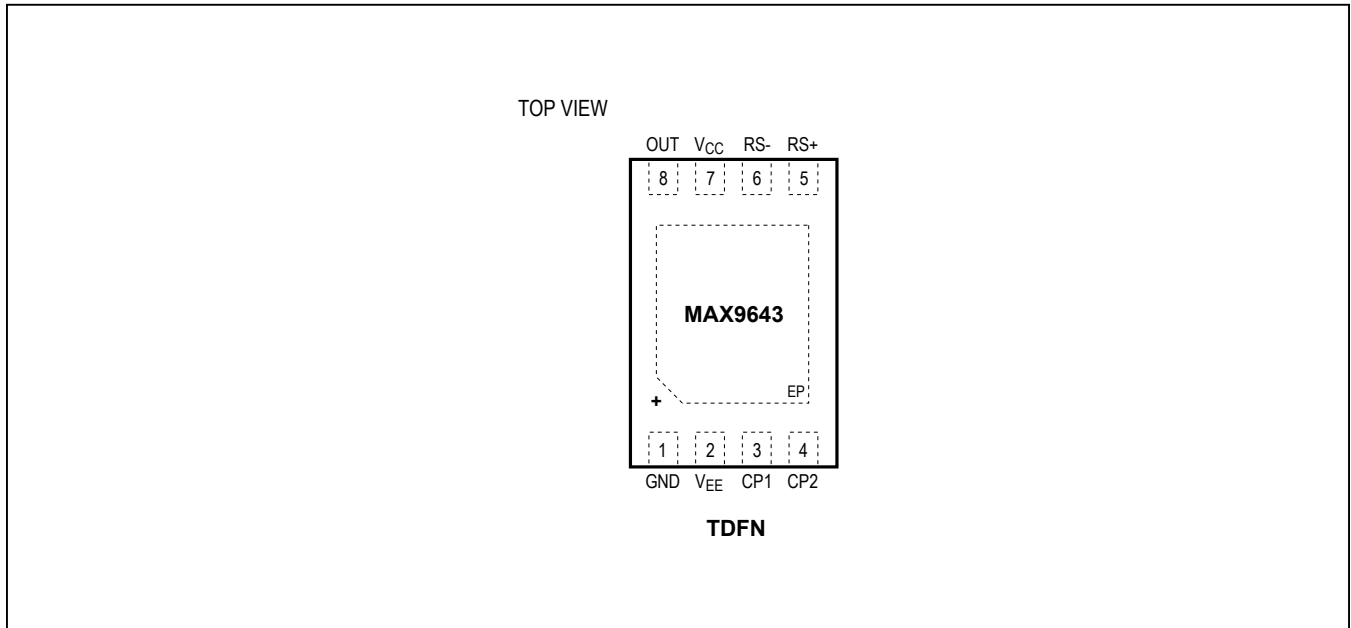

Pin Description

| PIN | NAME | FUNCTION |
|-----|-----------------|---|
| 1 | GND | Ground |
| 2 | V _{EE} | Charge-Pump Output. Connect 1 μ F to GND. |
| 3 | CP1 | Positive Terminal of 1 μ F Flying Capacitor |
| 4 | CP2 | Negative Terminal of 1 μ F Flying Capacitor |
| 5 | RS+ | Positive Sense Resistor Input |
| 6 | RS- | Negative Sense Resistor Input |
| 7 | V _{CC} | Power Supply |
| 8 | OUT | Output |
| — | EP | Exposed Pad. Must be externally connected to GND. |

Detailed Description

The MAX9643 is a high-speed precision current-sense amplifier ideal for a wide variety of high-performance industrial power-supply applications. The device's low input offset voltage, tight gain error, and low temperature drift characteristics allow the use of smallsense resistors for current measurements to improve power-supply conversion efficiency and accuracy of measurements. Its fast response allows it to react quickly to switching currents as is common in power-supply circuits, and makes it possible to be used as part of control loops.

The unidirectional high-side, current-sense amplifier also features a wide -1.5V to $+60\text{V}$ input common-mode range. This feature allows monitoring of power-supply load current even if the rail is shorted to ground. Highside current monitoring does not interfere with the ground path of the load being measured, making the IC particularly useful in a wide range of high-reliability systems.

The IC has been designed on a proprietary high-speed complementary BiCMOS SOI process. This high-voltage analog process is optimized for excellent AC dynamic performance, ultra-low noise, wide operating voltage range, and low-drift signal conditioning circuitry.

Applications Information

Internal Charge Pump

An internal charge pump on the part is utilized to provide two attractive application features:

- Input common-mode voltage range extends to 1.5V below ground.
- Output voltage range extends down to true ground.

A 250kHz internal charge pump is used to generate a negative voltage rail to bias both the input stage and output stage of the current-sense amplifier. Use a $1\mu\text{F}$ ceramic capacitor between the CP1 and CP2 pins of the IC, and ensure a tight layout to minimize loop area. Using a $1\mu\text{F}$ ceramic capacitor from V_{EE} to GND is essential to good low-noise performance.

It is possible to also connect the V_{EE} pin directly to an external -5V power supply. Ensure that this voltage is lower than the internally generated charge-pump voltage. The -4.7V voltage is the minimum necessary to guarantee the charge pump is turned off.

The MAX9643 EV kit shows a good example layout. A representation is shown in Figure 1.

Input Common-Mode Voltage Range

The use of an internal negative voltage rail for its input stage allows the current-sense amplifier to extend its input common-mode voltage below ground without any crossover inaccuracies. Crossover problems with precision can occur with alternate architectures of current-sense amplifiers that use two different input differential stages to cover the entire operating common-mode voltage range (either npn/pnp transistors or pnp transistor and resistor-based input stages).

The minimum input common-mode voltage capability is dependent on the internal negative voltage rail generated by the charge pump. Since this negative voltage rail goes down at low values of V_{CC} (i.e., when under 5V), the minimum input common-mode voltage rail is also limited at low V_{CC} .

The negative input common-mode voltage specification can be exceeded if the input current is limited to under 5mA . This is typically accomplished by using series input resistors. The input ESD structure for negative input common-mode voltages looks like 5 series-connected diodes. Assuming an on-drop of 0.7V per diode, negative

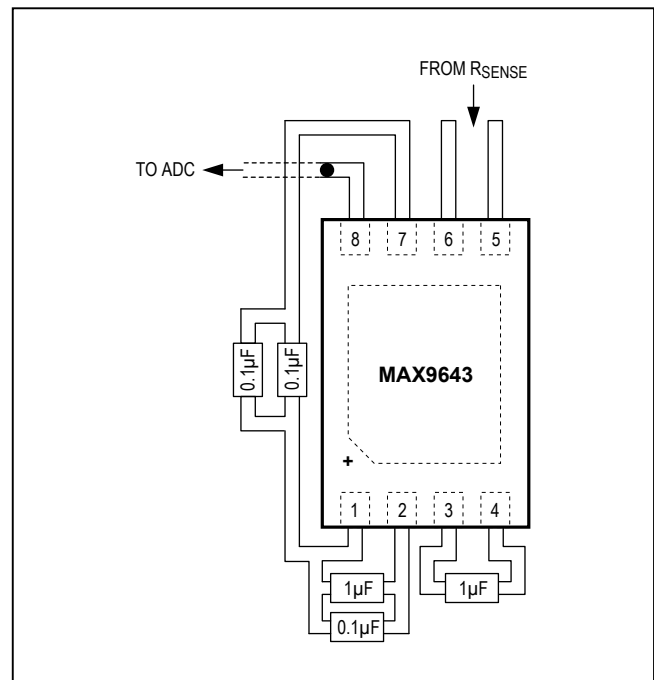

Figure 1. PCB Layout

input voltage transients below -3.5V should be limited by the use of input series resistors. For example, if an input voltage transient or fault condition of -12V were to occur in the application, use a resistor greater than $8.5\text{V}/5\text{mA} = 1700\Omega$. Use $2\text{k}\Omega$ for margin.

The maximum input common-mode voltage extends up to 60V over the entire V_{CC} range of 2.7V to 36V. It is recommended to shield the device from overvoltages above its 65V absolute maximum rating to protect the device.

Output Voltage Range

The internal negative voltage rail generated by the charge pump is also used to bias the output stage of the current-sense amplifier, allowing it to feature true $V_{OL} = 0\text{V}$ performance. This feature allows small sense voltages to be used and eases interface to other analog and mixed-signal ICs. In reality, attaining true $V_{OL} = 0\text{V}$ specification is usually limited by the offset voltage of the current-sense amplifier since $V_{OUT} = V_{OS} \times \text{gain}$, when input $V_{SENSE} = 0\text{V}$.

In addition, the maximum output voltage of the IC is internally clamped to less than 5V even when it is powered from a 40V rail. This allows easy interface to low-voltage downstream circuitry without worrying about protecting them from large input voltage transients or faults.

Common Mode and Differential Filtering

When the AC common-mode signal with large amplitudes ($>5V_{P-P}$ for example) at high frequencies ($> 1\text{kHz}$ for example) is present at the inputs, AC CMRR limitation causes spikes at the output as shown in the Common Mode graph in the *Typical Operating Characteristics*. Application Note 3888: *Performance of Current-Sense Amplifiers with Input Series Resistors* explains the way to filter out these common-mode transients as seen by the amplifier and filtering of the differential mode.

Chip Information

PROCESS: BICMOS

Choosing the Sense Resistor

Choose R_{SENSE} based on the following criteria:

- **Voltage loss:** A high R_{SENSE} value causes the power-source voltage to reduce due to IR drop. For minimal voltage loss, use the lowest R_{SENSE} value.
- **Accuracy:** A high R_{SENSE} value allows lower currents to be measured more accurately. This is because input offset voltages become less significant when the sense voltage is larger.
- **Efficiency and power dissipation:** At high current levels, the I^2R losses in R_{SENSE} can be significant. Take this into consideration when choosing the resistor value and its power dissipation (wattage) rating. Also, the sense resistor's value might drift if it is allowed to heat up excessively.
- **Inductance:** Keep inductance low if I_{SENSE} has a large high-frequency component. Because of the high currents that flow through R_{SENSE} , take care to eliminate parasitic trace resistance from causing errors in the sense voltage. Either use a four-terminal current-sense resistor or use Kelvin (force and sense) PCB layout techniques.

Power-Supply Bypassing and Grounding

For most applications, bypass V_{CC} to GND with a $0.1\mu\text{F}$ ceramic capacitor. In many applications, V_{CC} can be connected to one of the current monitor terminals (R_{S+} or R_{S-}). Because V_{CC} is independent of the monitored voltage, V_{CC} can be connected to a separate regulated supply. There are no specific power-supply sequencing issues to consider. The part can withstand 60V input common-mode voltages even when $V_{CC} = 0\text{V}$, and maintains a high input impedance in this application condition.

Ordering Information

| PART | PIN-PACKAGE | GAIN (V/V) | TEMP RANGE |
|--------------|-------------|------------|-----------------|
| MAX9643TATA+ | 8 TDFN-EP* | 2.5 | -40°C to +125°C |
| MAX9643UATA+ | 8 TDFN-EP* | 10 | -40°C to +125°C |

+Denotes a lead(Pb)-free/RoHS-compliant package.

*EP = Exposed paddle.

Package Information

For the latest package outline information and land patterns (footprints), go to www.maximintegrated.com/packages. Note that a "+", "#", or "-" in the package code indicates RoHS status only. Package drawings may show a different suffix character, but the drawing pertains to the package regardless of RoHS status.

| PACKAGE TYPE | PACKAGE CODE | OUTLINE NO. | LAND PATTERN NO. |
|--------------|--------------|-------------------------|-------------------------|
| 8 TDFN-EP | T823+1 | 21-0174 | 90-0091 |

Revision History

| REVISION NUMBER | REVISION DATE | DESCRIPTION | PAGES CHANGED |
|-----------------|---------------|---|---------------|
| 0 | 8/11 | Initial release | — |
| 1 | 2/13 | Updated <i>Electrical Characteristics</i> and <i>Typical Operating Characteristics</i> . Added the <i>Common Mode and Differential Filtering</i> section. | 3, 5, 6, 9 |
| 2 | 1/14 | Revised the <i>General Description, Benefits and Features, Electrical Characteristics, and Internal Charge Pump</i> sections. | 1–3, 8 |
| 3 | 10/14 | Removed automotive reference from data sheet | 1, 9 |
| 4 | 4/15 | Revised <i>Typical Operating Characteristics</i> | 5 |

For pricing, delivery, and ordering information, please contact Maxim Direct at 1-888-629-4642, or visit Maxim Integrated's website at www.maximintegrated.com.

Maxim Integrated cannot assume responsibility for use of any circuitry other than circuitry entirely embodied in a Maxim Integrated product. No circuit patent licenses are implied. Maxim Integrated reserves the right to change the circuitry and specifications without notice at any time. The parametric values (min and max limits) shown in the *Electrical Characteristics* table are guaranteed. Other parametric values quoted in this data sheet are provided for guidance.

X-ON Electronics

Largest Supplier of Electrical and Electronic Components

Click to view similar products for [Current Sense Amplifiers](#) category:

Click to view products by [Maxim](#) manufacturer:

Other Similar products are found below :

[MCP6C02T-050H/Q8B](#) [TSC210ICT](#) [WS74199Q-10/TR](#) [INA212BIDCKR](#) [NTE955M](#) [INA199C3DCKT](#) [FAN4010IL6X-F113](#)
[LT6100IDD#PBF](#) [LT1217CN8#PBF](#) [LMP8480ASQDGKRQ1](#) [INA212CIRSWT](#) [LMP8481AHQDGKRQ1](#) [LT6108HDCB-1#TRMPBF](#)
[INA211CIRSWT](#) [LT6108AHMS8-1#PBF](#) [INA214CIRSWR](#) [LT1620CMS8#PBF](#) [INA215CIDCKR](#) [LTC6101HVBCS5#TRMPBF](#)
[LT6106HS5#PBF](#) [NTE1609](#) [NTE926](#) [NTE955MC](#) [NTE955S](#) [NTE955SM](#) [NTE978](#) [NTE978C](#) [NTE978SM](#) [AD8211YRJZ-R2](#)
[AD8214ARMZ](#) [AD8214ARMZ-R7](#) [AD8218BCPZ-WP](#) [AD8290ACPZ-R2](#) [AD8290ACPZ-R7](#) [AD22057RZ](#) [AD8215YRZ](#) [AD8210YRZ](#)
[AD22057RZ-RL](#) [AD8210YRZ-REEL7](#) [AD8215WYRZ](#) [ADM4073FWRJZ-REEL7](#) [LT1999HMS8-50F#WPBF](#) [LT1999HMS8-10F#WPBF](#)
[LTC6102HVIMS8#PBF](#) [LTC6101AIMS8#PBF](#) [LTC6102CMS8-1#PBF](#) [MAX4080TASA+T](#) [LT1787HS8#PBF](#) [LT1620CS8#PBF](#)
[LTC6115HMS#PBF](#)