

MAX9647/MAX9648

General-Purpose, Low-Voltage, Tiny Pack Comparators

General Description

The MAX9647/MAX9648 comparators are drop-in, pin-for-pin compatible replacements for the LMX331/LMX331H. The MAX9648 has the added benefit of internal hysteresis to provide noise immunity, preventing output oscillations even with slow moving input signals.

Advantages of the ICs include low supply voltage, small package, and low cost. They also offer a wide supply voltage range, wide operating temperature range, competitive CMRR and PSRR, response time characteristics, input offset, low noise, output saturation voltage, input bias current, and RF immunity.

The ICs are available in both 5-pin SC70 and SOT23 packages.

Applications

Mobile Communications
Notebooks and PDAs
Battery-Powered Electronics
General-Purpose Portable Devices
General-Purpose Low-Voltage Applications

Features

- ◆ **Guaranteed +1.8V to +5.5V Performance**
- ◆ **-40°C to +125°C Automotive Temperature Range**
- ◆ **Low Supply Current (60µA/Channel at V_{DD} = +5.0V)**
- ◆ **Input Common-Mode Voltage Range Includes Ground**
- ◆ **No Phase Reversal for Overdriven Inputs**
- ◆ **Low Output Saturation Voltage (120mV)**
- ◆ **Internal 2mV Hysteresis (MAX9648)**
- ◆ **5-Pin SC70 Space-Saving Package (2.0mm x 2.1mm x 1.0mm)**

[Ordering Information](#) appears at end of data sheet.

MAX9647/MAX9648

General-Purpose, Low-Voltage, Tiny Pack Comparators

ABSOLUTE MAXIMUM RATINGS

| | | | |
|--|--|---|-----------------|
| Supply Voltage (V_{DD} to V_{SS})..... | -0.3V to +6V | SOT23 (derate 3.9mW/°C above +70°C) | 312.6mW |
| All Other Pins Except OUT..... | ($V_{SS} - 0.3V$) to ($V_{DD} + 0.3V$) | Operating Temperature Range | -40°C to +125°C |
| Differential Input Voltage (IN+ to IN-) | ±3.6V | Junction Temperature | +150°C |
| OUT | ($V_{SS} - 0.3V$) to +6V | Storage Temperature Range..... | -65°C to +150°C |
| Continuous Power Dissipation ($T_A = +70^\circ\text{C}$) | | Lead Temperature (soldering, 10s) | +300°C |
| SC70 (derate 3.1mW/°C above +70°C)..... | 247mW | Soldering Temperature (reflow) | +260°C |

Stresses beyond those listed under "Absolute Maximum Ratings" may cause permanent damage to the device. These are stress ratings only, and functional operation of the device at these or any other conditions beyond those indicated in the operational sections of the specifications is not implied. Exposure to absolute maximum rating conditions for extended periods may affect device reliability.

PACKAGE THERMAL CHARACTERISTICS (Note 1)

| | | | |
|---|---------|---|-----------|
| SC70 | SOT23 | | |
| Junction-to-Ambient Thermal Resistance (θ_{JA})..... | 324°C/W | Junction-to-Ambient Thermal Resistance (θ_{JA})..... | 255.9°C/W |
| Junction-to-Case Thermal Resistance (θ_{JC})..... | 115°C/W | Junction-to-Case Thermal Resistance (θ_{JC})..... | 81°C/W |

Note 1: Package thermal resistances were obtained using the method described in JEDEC specification JESD51-7, using a four-layer board. For detailed information on package thermal considerations, refer to www.maximintegrated.com/thermal-tutorial.

DC ELECTRICAL CHARACTERISTICS—2.7V OPERATION

($V_{DD} = 2.7V$, $V_{SS} = 0V$, $V_{CM} = 0V$, $R_L = 5.1k\Omega$ connected to V_{DD} , typical values are at $T_A = +25^\circ\text{C}$, unless otherwise noted. **Boldface** limits apply at the defined temperature extremes.) (Note 2)

| PARAMETER | SYMBOL | CONDITIONS | MIN | TYP | MAX | UNITS |
|--|------------|---|-----|---------|-------------|------------------------------|
| Input Offset Voltage | V_{OS} | | | 0.4 | 7 | mV |
| Input Voltage Hysteresis | V_{HYST} | MAX9648 only | | 2 | | mV |
| Input Offset Voltage Average Temperature Drift | TCV_{OS} | | | 1.5 | | $\mu\text{V}/^\circ\text{C}$ |
| Input Bias Current | I_B | $T_A = +25^\circ\text{C}$ | | ±0.0003 | ±250 | nA |
| | | $T_A = -40^\circ\text{C}$ to $+85^\circ\text{C}$ | | | ±400 | |
| | | $T_A = -40^\circ\text{C}$ to $+125^\circ\text{C}$ | | | ±400 | |
| Input Offset Current | I_{OS} | $T_A = +25^\circ\text{C}$ | | ±0.0003 | ±50 | nA |
| | | $T_A = -40^\circ\text{C}$ to $+85^\circ\text{C}$ | | | ±150 | |
| | | $T_A = -40^\circ\text{C}$ to $+125^\circ\text{C}$ | | | ±150 | |
| Input Voltage Range | V_{CM} | | | -0.1 | | V |
| | | | | 2.0 | | |
| Voltage Gain | A_V | MAX9647 only | | 500 | | V/mV |
| Output Saturation Voltage | V_{SAT} | $I_{SINK} \leq 1\text{mA}$ | | 25 | | mV |
| Output Sink Current | I_O | $V_O \leq 1.5V$ | 5 | 16 | | mA |
| Supply Current | I_S | (Note 3) | | 52 | 100 | μA |
| Output Leakage Current | | $T_A = +25^\circ\text{C}$ | | 0.005 | | μA |
| | | $T_A = -40^\circ\text{C}$ to $+85^\circ\text{C}$ | | | 1 | |
| | | $T_A = -40^\circ\text{C}$ to $+125^\circ\text{C}$ | | | 2 | |

MAX9647/MAX9648

General-Purpose, Low-Voltage, Tiny Pack Comparators

AC ELECTRICAL CHARACTERISTICS—2.7V OPERATION

($V_{DD} = 2.7V$, $V_{SS} = 0V$, $V_{CM} = 0V$, $R_L = 5.1k\Omega$ connected to V_{DD} , typical values are at $T_A = +25^\circ C$, unless otherwise noted. **Boldface** limits apply at the defined temperature extremes.) (Note 2)

| PARAMETER | SYMBOL | CONDITIONS | MIN | TYP | MAX | UNITS |
|---|-----------|-------------------------|-----|-----|-----|-------|
| Propagation Delay Output High to Low (Note 4) | t_{PHL} | Input overdrive = 10mV | | 70 | | ns |
| | | Input overdrive = 100mV | | 50 | | |
| Propagation Delay Output Low to High (Note 4) | t_{PLH} | Input overdrive = 10mV | | 115 | | ns |
| | | Input overdrive = 100mV | | 100 | | |

DC ELECTRICAL CHARACTERISTICS—5.0V OPERATION

($V_{DD} = 5V$, $V_{SS} = 0V$, $V_{CM} = 0V$, $R_L = 5.1k\Omega$ connected to V_{DD} , typical values are at $T_A = +25^\circ C$, unless otherwise noted. **Boldface** limits apply at the defined temperature extremes.) (Note 2)

| PARAMETER | SYMBOL | CONDITIONS | MIN | TYP | MAX | UNITS |
|--|------------|---------------------------------------|---------------------------------------|-------------|-----------------------------|------------------|
| Input Offset Voltage | V_{OS} | $T_A = +25^\circ C$ | | 0.4 | 7 | mV |
| | | $T_A = -40^\circ C$ to $+85^\circ C$ | | | 9 | |
| | | $T_A = -40^\circ C$ to $+125^\circ C$ | | | 9 | |
| Input Voltage Hysteresis | | MAX9648 only | | 2 | | mV |
| Input Offset Voltage Average Temperature Drift | TCV_{OS} | | | 1.5 | | $\mu V/^\circ C$ |
| Input Bias Current | I_B | $T_A = +25^\circ C$ | | ± 0.007 | ± 250 | nA |
| | | $T_A = -40^\circ C$ to $+85^\circ C$ | | | ± 400 | |
| | | $T_A = -40^\circ C$ to $+125^\circ C$ | | | ± 400 | |
| Input Offset Current | I_{OS} | $T_A = +25^\circ C$ | | ± 0.007 | ± 50 | nA |
| | | $T_A = -40^\circ C$ to $+85^\circ C$ | | | ± 150 | |
| | | $T_A = -40^\circ C$ to $+125^\circ C$ | | | ± 150 | |
| Input Voltage Range | V_{CM} | | | -0.1 | | V |
| | | | | 4.2 | | |
| Voltage Gain | A_V | MAX9647 only | 20 | 500 | | V/mV |
| Output Saturation Voltage | V_{SAT} | $I_{SINK} \leq 4mA$ | $T_A = +25^\circ C$ | 120 | 400 | mV |
| | | | $T_A = -40^\circ C$ to $+85^\circ C$ | | 700 | |
| | | | $T_A = -40^\circ C$ to $+125^\circ C$ | | 700 | |
| Output Sink Current | I_O | $V_O \leq 1.5V$ | 10 | 35 | | mA |
| Supply Current (Note 3) | I_S | $T_A = +25^\circ C$ | | 60 | 120 | μA |
| | | $T_A = -40^\circ C$ to $+85^\circ C$ | | | 150 | |
| | | $T_A = -40^\circ C$ to $+125^\circ C$ | | | 170 | |
| Output Leakage Current | | $T_A = +25^\circ C$ | | 0.005 | | μA |
| | | $T_A = -40^\circ C$ to $+85^\circ C$ | | | 1 | |
| | | $T_A = -40^\circ C$ to $+125^\circ C$ | | | 2 | |

MAX9647/MAX9648

General-Purpose, Low-Voltage, Tiny Pack Comparators

AC ELECTRICAL CHARACTERISTICS—5.0V OPERATION

($V_{DD} = 5V$, $V_{SS} = 0V$, $V_{CM} = 0V$, $R_L = 5.1k\Omega$ connected to V_{DD} , typical values are at $T_A = +25^\circ C$, unless otherwise noted. **Boldface** limits apply at the defined temperature extremes.) (Note 2)

| PARAMETER | SYMBOL | CONDITIONS | MIN | TYP | MAX | UNITS |
|---|-----------|-------------------------|-----|-----|-----|-------|
| Propagation Delay Output High to Low (Note 4) | t_{PHL} | Input overdrive = 10mV | | 70 | | ns |
| | | Input overdrive = 100mV | | 50 | | |
| Propagation Delay Output Low to High (Note 4) | t_{PLH} | Input overdrive = 10mV | | 110 | | ns |
| | | Input overdrive = 100mV | | 100 | | |

DC ELECTRICAL CHARACTERISTICS—1.8V OPERATION

($V_{DD} = 1.8V$, $V_{SS} = 0V$, $V_{CM} = 0V$, $R_L = 5.1k\Omega$ connected to V_{DD} , typical values are at $T_A = +25^\circ C$, unless otherwise noted. **Boldface** limits apply at the defined temperature extremes.) (Note 2)

| PARAMETER | SYMBOL | CONDITIONS | MIN | TYP | MAX | UNITS |
|--|------------|-------------------------|-----|--------|-----|------------------|
| Input Offset Voltage | V_{OS} | | | 0.4 | 5 | mV |
| Input Voltage Hysteresis | | MAX9648 only | | 2 | | mV |
| Input Offset Voltage Average Temperature Drift | TCV_{OS} | | | 1.5 | | $\mu V/^\circ C$ |
| Input Bias Current | I_B | | | 0.0003 | | nA |
| Input Offset Current | I_{OS} | | | 0.0003 | | nA |
| Input Voltage Range | V_{CM} | | | -0.1 | | V |
| | | | | 1 | | |
| Output Saturation Voltage | V_{SAT} | $I_{SINK} \leq 1mA$ | | 56 | | mV |
| Power-Supply Rejection Ratio | PSRR | $V_{DD} = 1.8V$ to 5.5V | 60 | 90 | | dB |
| Output Sink Current | I_O | $V_O \leq 1.5V$ | | 6.4 | | mA |
| Supply Current | I_S | (Note 3) | | 50 | 100 | μA |
| Output Leakage Current | | | | 0.001 | | μA |

AC ELECTRICAL CHARACTERISTICS—1.8V OPERATION

($V_{DD} = 1.8V$, $V_{SS} = 0V$, $V_{CM} = 0V$, $R_L = 5.1k\Omega$ connected to V_{DD} , typical values are at $T_A = +25^\circ C$, unless otherwise noted. **Boldface** limits apply at the defined temperature extremes.) (Note 2)

| PARAMETER | SYMBOL | CONDITIONS | MIN | TYP | MAX | UNITS |
|---|-----------|-------------------------|-----|-----|-----|-------|
| Propagation Delay Output High to Low (Note 4) | t_{PHL} | Input overdrive = 10mV | | 70 | | ns |
| | | Input overdrive = 100mV | | 60 | | |
| Propagation Delay Output Low to High (Note 4) | t_{PLH} | Input overdrive = 10mV | | 120 | | ns |
| | | Input overdrive = 100mV | | 110 | | |

Note 2: All devices are production tested at $T_A = +25^\circ C$. All temperature limits are guaranteed by design.

Note 3: Supply current when output is high.

Note 4: Input overdrive is the overdrive voltage beyond the offset and hysteresis-determined trip points.

MAX9647/MAX9648

General-Purpose, Low-Voltage, Tiny Pack Comparators

Typical Operating Characteristics

($V_{DD} = 5V$, $V_{SS} = 0V$, $V_{CM} = 0V$, $R_L = 5.1k\Omega$, $C_L = 10pF$, overdrive = 100mV, $T_A = +25^\circ C$, unless otherwise noted.)

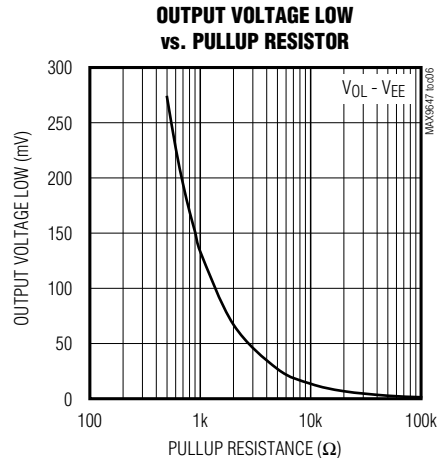
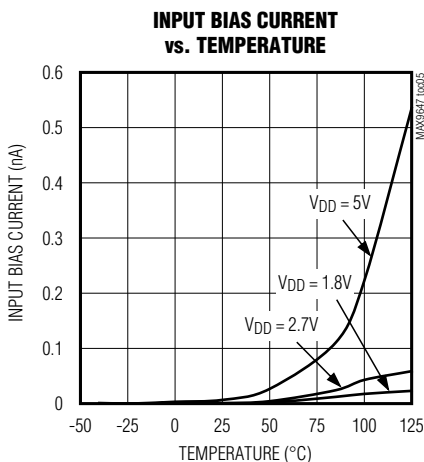
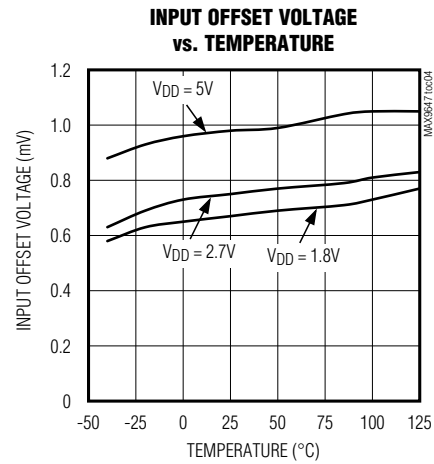
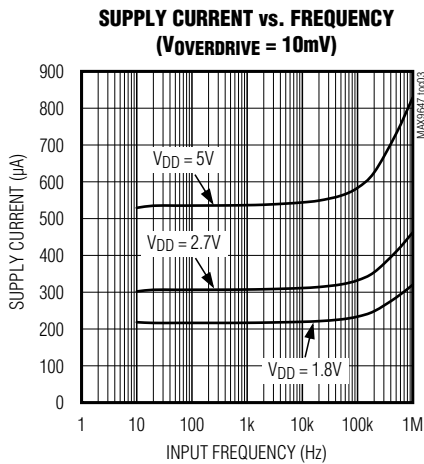
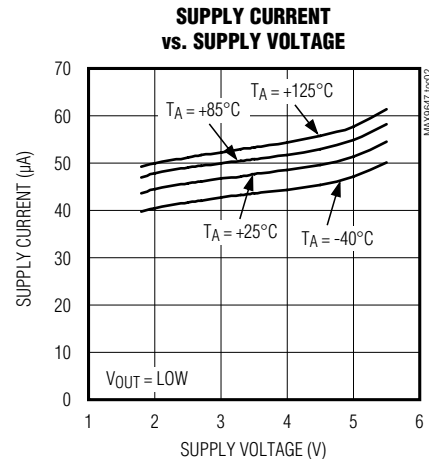
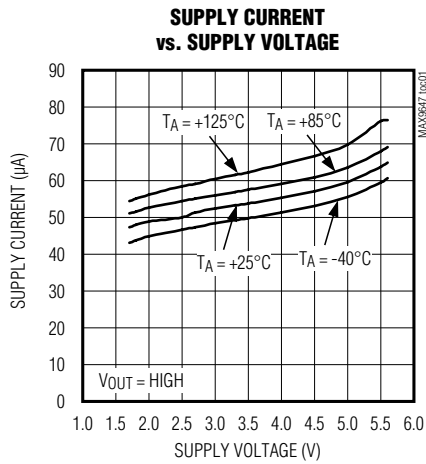

MAX9647/MAX9648

General-Purpose, Low-Voltage, Tiny Pack Comparators

Typical Operating Characteristics (continued)

($V_{DD} = 5V$, $V_{SS} = 0V$, $V_{CM} = 0V$, $R_L = 5.1k\Omega$, $C_L = 10pF$, overdrive = 100mV, $T_A = +25^\circ C$, unless otherwise noted.)

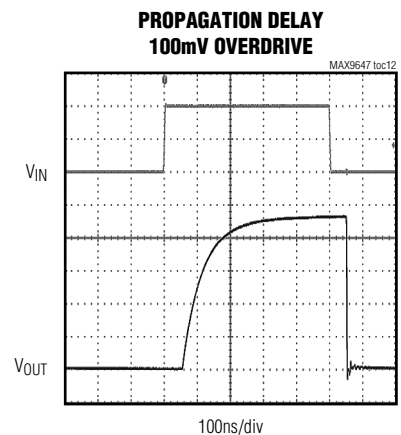
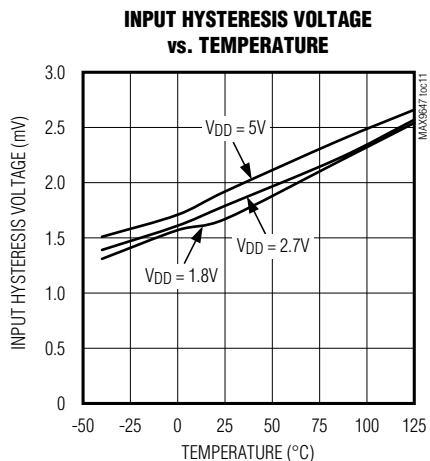
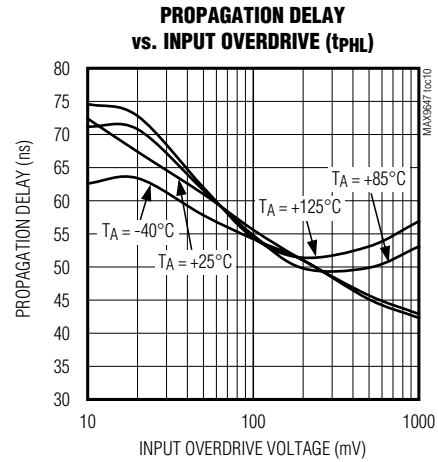
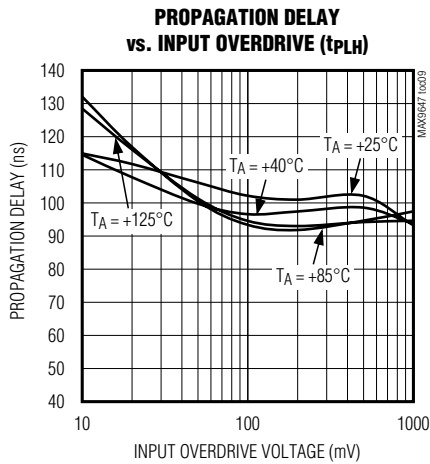
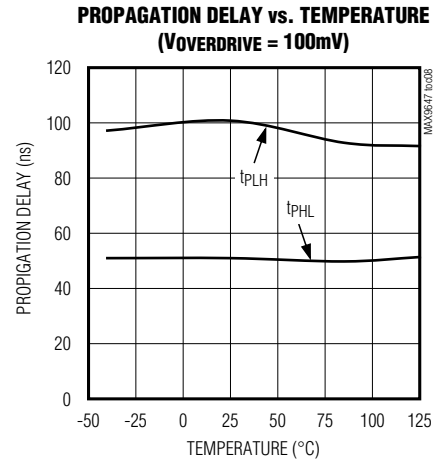
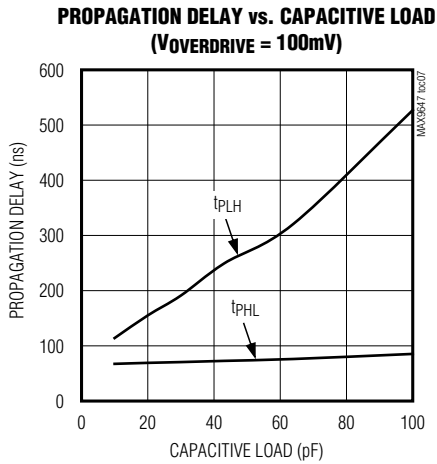

MAX9647/MAX9648

General-Purpose, Low-Voltage, Tiny Pack Comparators

Typical Operating Characteristics (continued)

($V_{DD} = 5V$, $V_{SS} = 0V$, $V_{CM} = 0V$, $R_L = 5.1k\Omega$, $C_L = 10pF$, overdrive = 100mV, $T_A = +25^\circ C$, unless otherwise noted.)

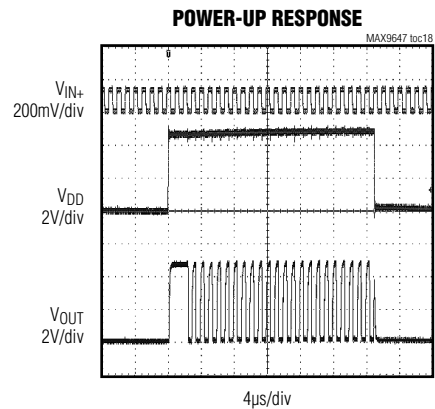
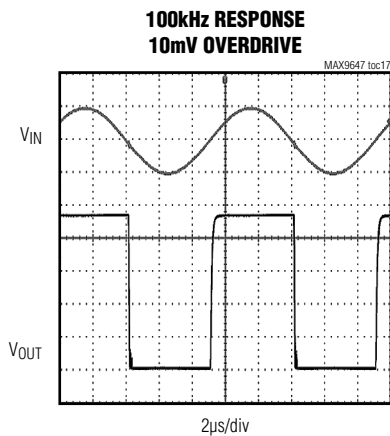
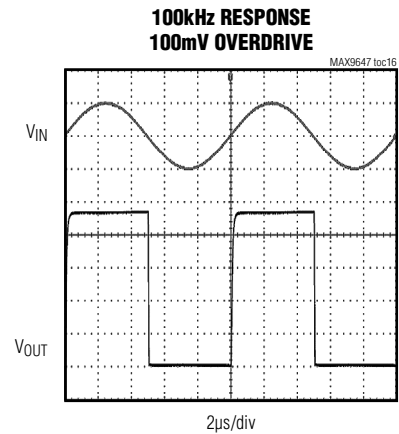
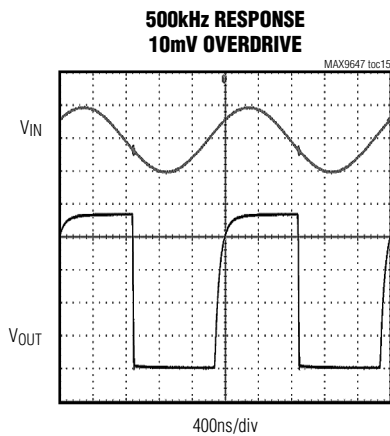
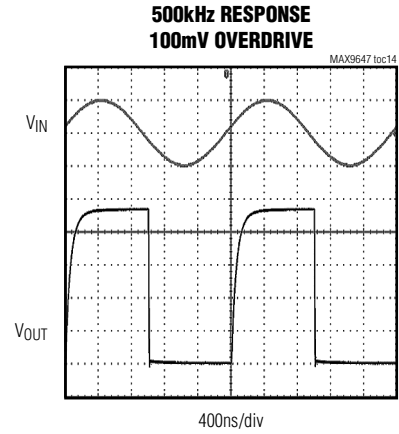
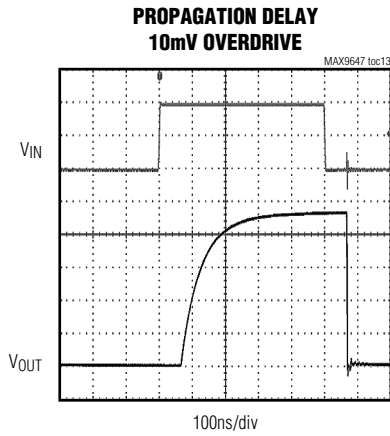

MAX9647/MAX9648

General-Purpose, Low-Voltage, Tiny Pack Comparators

Pin Configuration

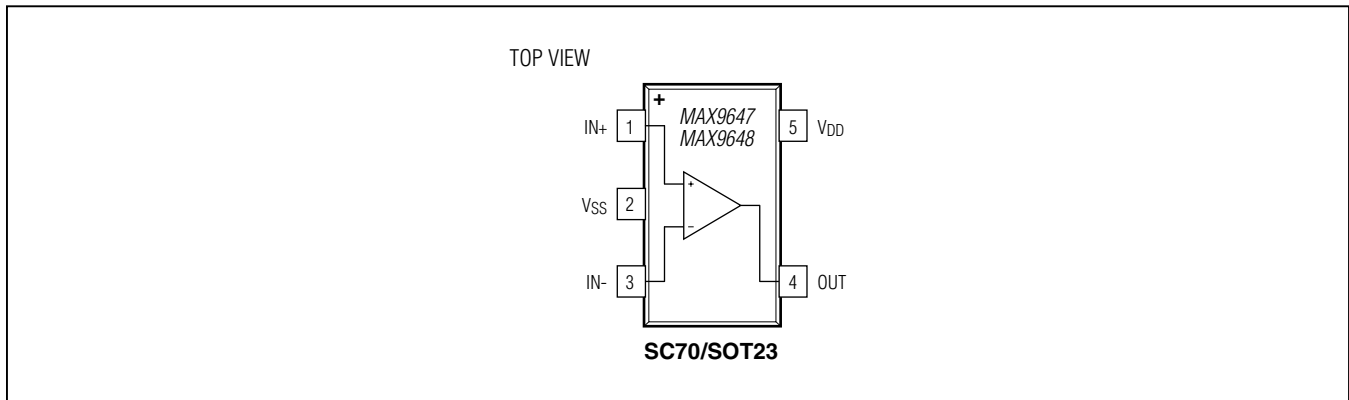

Pin Description

| PIN | NAME | FUNCTION |
|-----|-----------------|----------------------------------|
| 1 | IN+ | Noninverting Input |
| 2 | V _{SS} | Negative Supply (Connect to GND) |
| 3 | IN- | Inverting Input |
| 4 | OUT | Comparator Output (Open Drain) |
| 5 | V _{DD} | Positive Supply |

Detailed Description

The MAX9647/MAX9648 are low-cost, general-purpose comparators that have a single-supply +1.8V to +5V operating voltage range. The common-mode input range extends from -0.1V below the negative supply to within +0.7V of the positive supply. They require approximately 60μA per comparator with a 5V supply and 52μA with a 2.7V supply.

The MAX9648 has 2mV of hysteresis for noise immunity. This significantly reduces the chance of output oscillations even with slow-moving input signals. See the [Typical Operating Characteristics](#).

Applications Information

Hysteresis

Many comparators oscillate in the linear region of operation because of noise or undesired parasitic feedback. This tends to occur when the voltage on one input is equal or very close to the voltage on the other input. The MAX9648 has internal hysteresis to counter parasitic effects and noise.

The hysteresis in a comparator creates two trip points: one for the rising input voltage and one for the falling input voltage ([Figure 1](#)). The difference between the trip points is the hysteresis. When the comparator's input voltages are equal, the hysteresis effectively causes one comparator input to move quickly past the other, thus taking the input out of the region where oscillation occurs. This provides clean output transitions for noisy, slow-moving input signals.

MAX9647/MAX9648

General-Purpose, Low-Voltage, Tiny Pack Comparators

Additional hysteresis can be generated with two resistors using positive feedback (Figure 2). Use the following procedure to calculate resistor values:

- 1) Find output voltage when output is high:

$$V_{OUT(HIGH)} = V_{DD} - I_{LOAD} \times R_L$$

- 2) Find the trip points of the comparator using these formulas:

$$V_{TH} = V_{REF} + ((V_{OUT(HIGH)} - V_{REF})R_2)/(R_1 + R_2)$$

$$V_{TL} = V_{REF} (1 - (R_2/(R_1 + R_2)))$$

where V_{TH} is the threshold voltage at which the comparator switches its output from high to low as V_{IN} rises above the trip point, and V_{TL} is the threshold voltage at which the comparator switches its output from low to high as V_{IN} drops below the trip point.

- 3) The hysteresis band is:

$$V_{HYST} = V_{TH} - V_{TL} = V_{DD}(R_2/(R_1 + R_2))$$

In this example, let $V_{DD} = 5V$, $V_{REF} = 2.5V$, $I_{LOAD} = 50nA$, and $R_L = 5.1k\Omega$.

$$V_{OUT(HIGH)} = 5.0V - (50 \times 10^{-9} \times 5.1 \times 10^3\Omega) \approx 5.0V$$

$$V_{TH} = 2.5 + 2.5(R_2/(R_1 + R_2))$$

$$V_{TL} = 2.5(1 - (R_2/(R_1 + R_2)))$$

Select R_2 . In this example, choose $1k\Omega$.

Select V_{HYST} . In this example, choose $50mV$.

Solve for R_1 .

$$V_{HYST} = V_{OUT(HIGH)}(R_2/(R_1 + R_2))V$$

$$0.050V = 5(1000/(R_1 + 1000))V$$

where $R_1 \approx 100k\Omega$, $V_{TH} = 2.525V$, and $V_{TL} = 2.475V$

Choose R_1 and R_2 to be large enough as not to exceed the amount of current the reference can supply.

The source current required is $V_{REF}/(R_1 + R_2)$.

The sink current is $(V_{OUT(HIGH)} - V_{REF}) \times (R_1 + R_2)$.

Choose R_L to be large enough to avoid drawing excess current, yet small enough to supply the necessary current to drive the load. R_L should be between $1k\Omega$ and $10k\Omega$. Choose R_1 to be much larger than R_L to avoid lowering $V_{OUT(HIGH)}$ or raising $V_{OUT(LOW)}$.

Board Layout and Bypassing

Use $0.1\mu F$ bypass capacitors from V_{DD} to V_{SS} . To maximize performance, minimize stray inductance by putting this capacitor close to the V_{DD} pin and reducing trace lengths. For slow moving input signals (rise time $> 1ms$), use a $1nF$ capacitor between $IN+$ and $IN-$ to reduce high-frequency noise.

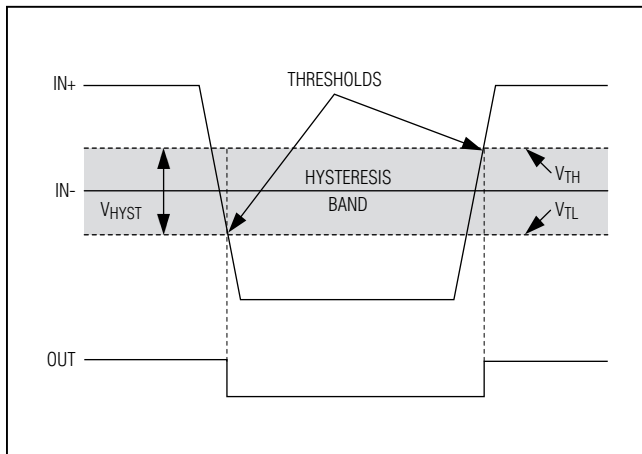

Figure 1. Threshold Hysteresis Band (Not to Scale)

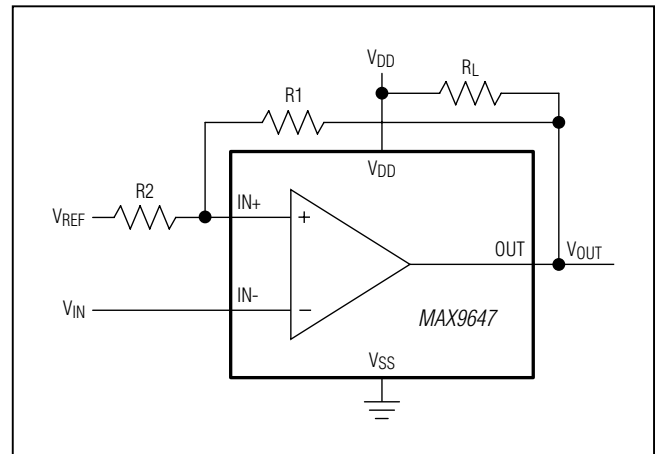

Figure 2. Adding Hysteresis with External Resistors

MAX9647/MAX9648

General-Purpose, Low-Voltage, Tiny Pack Comparators

Chip Information

PROCESS: BiCMOS

Ordering Information

| PART | TEMP RANGE | PIN-PACKAGE | TOP MARK |
|----------------------|-----------------|-------------|----------|
| MAX9647 AXK+T | -40°C to +125°C | 5 SC70 | +AUS |
| MAX9647AUK+T | -40°C to +125°C | 5 SOT23 | +AFLM |
| MAX9648 AXK+T | -40°C to +125°C | 5 SC70 | +AUT |
| MAX9648AUK+T | -40°C to +125°C | 5 SOT23 | +AFLN |

+Denotes a lead(Pb)-free/RoHS-compliant package.

T = Tape and reel.

Package Information

For the latest package outline information and land patterns (footprints), go to www.maximintegrated.com/packages. Note that a "+", "#", or "-" in the package code indicates RoHS status only. Package drawings may show a different suffix character, but the drawing pertains to the package regardless of RoHS status.

| PACKAGE TYPE | PACKAGE CODE | OUTLINE NO. | LAND PATTERN NO. |
|--------------|--------------|-------------------------|-------------------------|
| 5 SC70 | X5+1 | 21-0076 | 90-0188 |
| 5 SOT23 | U5+1 | 21-0057 | 90-0174 |

MAX9647/MAX9648

General-Purpose, Low-Voltage, Tiny Pack Comparators

Revision History

| REVISION NUMBER | REVISION DATE | DESCRIPTION | PAGES CHANGED |
|-----------------|---------------|--|---------------|
| 0 | 10/11 | Initial release | — |
| 1 | 1/12 | Revised the <i>Typical Operating Characteristics</i> . | 6 |
| 2 | 1/13 | Updated the <i>Absolute Maximum Ratings</i> , added the <i>Package Thermal Characteristics</i> , and revised the <i>Electrical Characteristics</i> . | 2–4 |
| 3 | 4/15 | No <i>V</i> OPNs; deleted “Automotive Applications” from <i>Applications</i> section and automotive reference from <i>Detailed Description</i> section | 1, 8 |



Maxim Integrated cannot assume responsibility for use of any circuitry other than circuitry entirely embodied in a Maxim Integrated product. No circuit patent licenses are implied. Maxim Integrated reserves the right to change the circuitry and specifications without notice at any time. The parametric values (min and max limits) shown in the Electrical Characteristics table are guaranteed. Other parametric values quoted in this data sheet are provided for guidance.

X-ON Electronics

Largest Supplier of Electrical and Electronic Components

Click to view similar products for [Other Development Tools](#) category:

Click to view products by [Maxim](#) manufacturer:

Other Similar products are found below :

[BK0004](#) [BK0012](#) [MAX9684EVKIT#](#) [EVAL01-HMC749LC3C](#) [410-320](#) [TPD6F002-Q1EVM](#) [TS9002DB](#) [118777-HMC722LC3C](#) [118777-HMC723LC3C](#) [DC1765A-A](#) [125614-HMC851LC3C](#) [DC2062A-A](#) [LMH6321MR-EVAL/NOPB](#) [EVAL01-HMC747LC3C](#) [4537](#) [DK-M3F-1.8-TRK-1.5-S](#) [DK-M3-FS-1.8-1.5-M12/16](#) [DK-M3-LS-1.8-6](#) [ADALP2000](#) [EVAL-CN0202-SDPZ](#) [EVAL-CN0203-SDPZ](#) [EVAL-CN0204-SDPZ](#) [EVAL-CN0209-SDPZ](#) [EVAL-CN0229-SDPZ](#) [EVAL-CN0251-SDPZ](#) [EVAL-CN0272-SDPZ](#) [EVAL-CN0301-SDPZ](#) [EVAL-CN0355-PMDZ](#) [EVAL-CN0364-SDPZ](#) [EVAL-SDP-CB1Z](#) [MAX4951AEEVKIT+](#) [MAXREFDES60#](#) [BK0010](#) [EFIELDDEV](#) [PD70224EVB](#) [MIKROE-3319](#) [MIKROE-3357](#) [MIKROE-4048](#) [MIKROE-1370](#) [MIKROE-1899](#) [MIKROE-1901](#) [MIKROE-1910](#) [MIKROE-1917](#) [MIKROE-1993](#) [MIKROE-3116](#) [MIKROE-957](#) [BB-GEVK](#) [NCS2200AGEVB](#) [27115](#) [64019](#)