

Click [here](#) to ask about the production status of specific part numbers.

## MAX98396

# 20V Digital Input Class-DG Amplifier with I/V Sense and Brownout Prevention

### General Description

The MAX98396 is a high-efficiency, mono Class-DG speaker amplifier with industry-leading quiescent power featuring I/V sense, brownout-prevention engine (BPE), and dynamic-headroom tracking (DHT). The IC enables ultrasound applications by providing support for sample rates up to 192kHz, a higher passband (for  $f_s > 50\text{kHz}$ ), and a bypass path for the ultrasound signals through the amplifier so it is not attenuated by the audio processing. Precision output current and voltage monitoring (I/V sense) enables the host device to run speaker protection algorithms. Spread-spectrum modulation (SSM) and edge rate control minimize EMI and eliminate the need for the output filtering found in traditional Class-D devices.

To achieve industry-leading quiescent power, the Class-DG amplifier employs two supply rails VBAT (3V to 5.5V) and PVDD (3V to 20V) to supply the speaker amplifier. The Class-DG amplifier switches between the two supply rails depending on the input signal level and/or the supply headroom. The brownout-prevention engine in the device allows it to reduce its contribution to the overall system power consumption by either attenuating or limiting the amplifier output when the device supply drops below a set of programmable thresholds. Additionally, as the power supply voltage varies due to sudden transients and declining battery life, DHT automatically optimizes the headroom available to the Class-DG amplifier to maintain consistent distortion and listening levels.

The device provides a PCM interface for audio data and a standard I<sup>2</sup>C interface for control data communication. The PCM interface supports audio playback using I<sup>2</sup>S, left-justified, and TDM audio data formats. A unique clocking structure eliminates the need for an external master clock for PCM communication, which reduces pin count and simplifies board layout. Enabling thermal foldback automatically reduces the output power when the temperature exceeds a user specified threshold. This allows for uninterrupted music playback even at high ambient temperatures. Traditional thermal protection is also available in addition to robust overcurrent protection.

The device is available in a 0.4mm pitch, 35-bump wafer-level package (WLP). The device operates over the extended -40°C to +85°C temperature range.

### Applications

- Mobile Speakers • Smart Speakers • Smart IoT • Tablets
- Notebook Computers • Soundbars

SMBus is a trademark of Intel Corp.

### Benefits and Features

- Wide Input Supply Range (3.0V to 20V)
- Class-DG Operation Enables Industry-Leading Quiescent Power
  - 12.7mW at  $V_{PVDD} = 12\text{V}$ ,  $V_{VBAT} = 3.8\text{V}$
  - 18mW at  $V_{PVDD} = 19\text{V}$ ,  $V_{VBAT} = 5.0\text{V}$
- Ultra-Low Noise Floor
  - 15.5 $\mu\text{VRMS}$  Output Noise
  - 118dB Dynamic Range
- Low Distortion
  - -82dB THD+N at 1W into 8 $\Omega$ ,  $f = 1\text{kHz}$
  - -76dB THD+N at 1W into 8 $\Omega$ ,  $f = 6\text{kHz}$
- Output Power at 1% THD+N:
  - 20W into 8 $\Omega$ ,  $V_{PVDD} = 19\text{V}$
  - 19W into 4 $\Omega$ ,  $V_{PVDD} = 14\text{V}$
- 60W Peak Output Power into 4 $\Omega$ ,  $V_{PVDD} = 19\text{V}$
- Speaker Amplifier Efficiency:
  - 87% at 1W into 8 $\Omega$ ,  $V_{PVDD} = 12\text{V}$ ,  $V_{VBAT} = 3.8\text{V}$
  - 83% at 1W into 4 $\Omega$ ,  $V_{PVDD} = 12\text{V}$ ,  $V_{VBAT} = 3.8\text{V}$
  - 83% at 1W into 8 $\Omega$ ,  $V_{PVDD} = 19\text{V}$ ,  $V_{VBAT} = 5.0\text{V}$
  - 91% at 20W into 8 $\Omega$ ,  $V_{PVDD} = 19\text{V}$ ,  $V_{VBAT} = 5.0\text{V}$
- Class-D EMI Reduction Enables Filterless Operation
- Spread-Spectrum Modulation
- Switching-Edge Rate Control
- Integrated Speaker Current and Voltage Sense do not Require External Components
- Flexible Brownout-Prevention Engine
- I<sup>2</sup>S/16-Channel TDM and I<sup>2</sup>C Digital Interfaces
- Playback Support for 16-, 24-, and 32-Bit Data Words
- Playback and I/V Sense Support Sample Rates up to 192kHz
- Audio Processing Bypass Path
- Dynamic-Headroom Tracking Maintains a Consistent Listening Experience
- Extensive Click-and-Pop Suppression
- 35-Bump, WLP (0.4mm Pitch)

**Ordering Information appears at end of data sheet.**

Simplified Block Diagram

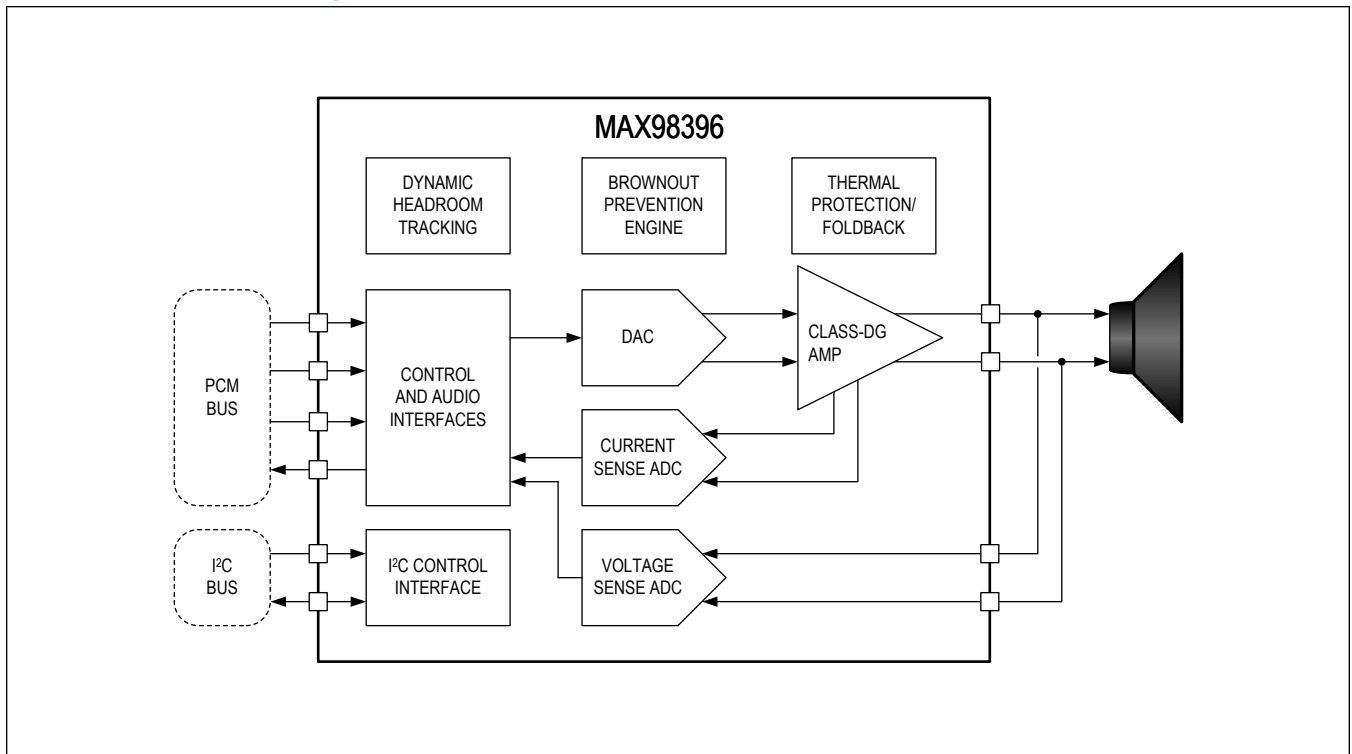

---

**TABLE OF CONTENTS**

---

General Description . . . . .	1
Applications . . . . .	1
Benefits and Features . . . . .	1
Simplified Block Diagram . . . . .	2
Absolute Maximum Ratings . . . . .	10
Package Information . . . . .	10
35 WLP . . . . .	10
Electrical Characteristics . . . . .	11
Typical Operating Characteristics . . . . .	26
Pin Configuration . . . . .	36
35 WLP . . . . .	36
Pin Description . . . . .	36
Functional Diagrams . . . . .	38
Detailed Block Diagram . . . . .	38
Detailed Description . . . . .	39
Device State Control . . . . .	39
Hardware Shutdown State . . . . .	39
Software Shutdown State . . . . .	39
Active State . . . . .	40
Device Sequencing . . . . .	40
PCM Interface . . . . .	41
PCM Clock Configuration . . . . .	41
PCM Data Format Configuration . . . . .	41
I <sup>2</sup> S/Left-Justified Mode . . . . .	41
TDM Modes . . . . .	43
PCM Data Path Configuration . . . . .	45
PCM Data Input . . . . .	46
PCM Data Output . . . . .	46
Data Output Channel-Interleaved I/V Sense Data . . . . .	47
Data Output Status Bits . . . . .	48
PCM Interface Timing . . . . .	49
Interrupts . . . . .	49
Interrupt Bit Field Composition . . . . .	49
Interrupt Output Configuration . . . . .	50
Interrupt Sources . . . . .	50
Speaker Path . . . . .	52
Speaker Path Block Diagram . . . . .	52
Speaker Playback Path . . . . .	52

**TABLE OF CONTENTS (CONTINUED)**

Speaker Path Noise Gate . . . . .	52
Speaker Path Dither . . . . .	53
Speaker Path Data Inversion . . . . .	53
Speaker Path DC Blocking Filter . . . . .	53
Speaker Path Digital Volume Control . . . . .	53
Speaker Path Digital Gain Control . . . . .	53
Speaker Path DSP Data Feedback Path . . . . .	53
Speaker Safe Mode . . . . .	53
Speaker Audio Processing Bypass Path . . . . .	53
Bypass Path Data Inversion . . . . .	54
Bypass Path Dither . . . . .	54
Bypass Path DC Blocking Filter . . . . .	54
Speaker Maximum Peak Output Voltage Scaling . . . . .	54
Dynamic-Headroom Tracking (DHT) . . . . .	54
DHT Supply Tracking and Headroom . . . . .	55
DHT Mode 1 – Signal Distortion Limiter . . . . .	56
DHT Mode 2 – Signal Level Limiter . . . . .	60
DHT Mode 3: Dynamic Range Compressor . . . . .	62
DHT Mode 4: Dynamic Range Compressor with Signal Level Limiter . . . . .	64
DHT Attenuation . . . . .	66
DHT Attenuation Reporting . . . . .	68
DHT Ballistics . . . . .	68
Speaker Amplifier . . . . .	69
Speaker Amplifier Operating Modes . . . . .	69
Class-DG Mode Enabled . . . . .	69
Delay for DG Mode . . . . .	69
Class-DG Mode Disabled . . . . .	70
NOVBAT Mode . . . . .	70
IDLE Mode . . . . .	70
Speaker Amplifier Ultra-Low EMI Filterless Operation . . . . .	70
Speaker Amplifier Overcurrent Protection . . . . .	71
Speaker Current and Voltage Sense ADC Path . . . . .	71
Brownout-Prevention Engine . . . . .	71
BPE State Controller and Level Thresholds . . . . .	72
BPE Level Configuration Options . . . . .	73
BPE Gain Attenuation Function . . . . .	73
BPE Limiter Function . . . . .	73
Brownout Interrupts . . . . .	73

**TABLE OF CONTENTS (CONTINUED)**

Measurement ADC . . . . .	74
Measurement ADC Thermal Channel . . . . .	74
Measurement ADC PVDD Channel . . . . .	74
Measurement ADC VBAT Channel . . . . .	74
Clock and Data Monitors . . . . .	75
Input Data Monitor . . . . .	75
Clock Monitor . . . . .	76
Clock Activity and Frequency Detection . . . . .	76
Clock Frame Error Detection . . . . .	77
Speaker Monitor . . . . .	77
Thermal Protection . . . . .	78
Thermal Warning and Thermal Shutdown Configuration . . . . .	78
Thermal Shutdown Recovery Configuration . . . . .	78
Thermal Foldback . . . . .	78
Tone Generator . . . . .	79
Pink Noise Generator . . . . .	79
Interchip Communication . . . . .	79
ICC Operation and Data Format . . . . .	79
Multiamplifier Grouping . . . . .	80
i <sup>2</sup> C Serial Interface . . . . .	81
Slave Address . . . . .	81
Bit Transfer . . . . .	82
START and STOP Conditions . . . . .	82
Early STOP Conditions . . . . .	83
Acknowledge . . . . .	83
Write Data Format . . . . .	83
Read Data Format . . . . .	84
i <sup>2</sup> C Register Map . . . . .	85
Control Bit Field Types and Write Access Restrictions . . . . .	85
Register Map . . . . .	87
Register Map . . . . .	87
Register Details . . . . .	95
Applications Information . . . . .	170
Layout and Grounding . . . . .	170
Recommended External Components . . . . .	170
Typical Application Circuits . . . . .	171
Typical Application Circuit . . . . .	171
Ordering Information . . . . .	171

---

**TABLE OF CONTENTS (CONTINUED)**

---

Revision History ..... 172

---

**LIST OF FIGURES**

---

Figure 1. Standard I <sup>2</sup> S Mode	42
Figure 2. Left-Justified Mode	42
Figure 3. Left-Justified Mode (LRCLK Inverted)	43
Figure 4. Left-Justified Mode (BCLK Inverted)	43
Figure 5. TDM Modes	45
Figure 6. PCM Data Input	46
Figure 7. I/V Sense Path Data Interleaved on a Single Data Output Channel	48
Figure 8. PCM Interface Timing/Slave Mode—LRCLK, BCLK, DIN Timing Diagram	49
Figure 9. PCM Interface Timing/DOUT Timing Diagram	49
Figure 10. Speaker Signal Path Diagram	52
Figure 11. Simplified Dynamic-Headroom Tracking System Block Diagram	54
Figure 12. V <sub>TPO</sub> and A <sub>TPO</sub> Calculation Example	56
Figure 13. Signal Distortion Limiter with V <sub>MPO</sub> ≤ V <sub>SUP</sub> and +20% Headroom (S <sub>UPHR</sub> )	57
Figure 14. Signal Distortion Limiter with V <sub>MPO</sub> ≤ V <sub>SUP</sub> and 0% Headroom (S <sub>UPHR</sub> )	57
Figure 15. Signal Distortion Limiter with V <sub>MPO</sub> ≤ V <sub>SUP</sub> and -20% Headroom (S <sub>UPHR</sub> )	58
Figure 16. Signal Distortion Limiter with V <sub>MPO</sub> > V <sub>SUP</sub> and +20% Headroom (S <sub>UPHR</sub> )	59
Figure 17. Signal Distortion Limiter with V <sub>MPO</sub> > V <sub>SUP</sub> and 0% Headroom (S <sub>UPHR</sub> )	59
Figure 18. Signal Distortion Limiter with V <sub>MPO</sub> > V <sub>SUP</sub> and -20% Headroom (S <sub>UPHR</sub> )	60
Figure 19. Signal Level Limiter with V <sub>TPO</sub> > V <sub>SLL</sub> as V <sub>SUP</sub> Decreases	61
Figure 20. Signal Level Limiter with V <sub>TPO</sub> < V <sub>SLL</sub> Showing Amplifier Output Clipping	62
Figure 21. Dynamic Range Compression with Decreasing V <sub>SUP</sub> and S <sub>UPHR</sub> ≥ 0%	63
Figure 22. Dynamic Range Compressor with S <sub>UPHR</sub> < 0% and Output Clipping	64
Figure 23. DHT DRC and SLL with Decreasing V <sub>SUP</sub> (V <sub>TPO</sub> ), and S <sub>UPHR</sub> ≥ 0%	65
Figure 24. DHT DRC and SLL with Decreasing V <sub>SUP</sub> (V <sub>TPO</sub> ), and S <sub>UPHR</sub> < 0%	66
Figure 25. Distortion Limiter Case with -20% Headroom and A <sub>MAX</sub> Exceeded	67
Figure 26. Distortion Limiter Case with +20% Headroom and A <sub>MAX</sub> Exceeded	68
Figure 27. BPE Block Diagram	72
Figure 28. Data Monitor Error Generation due to Input Data Stuck Error Detection	75
Figure 29. Monitor Error Generation due to Input Data Magnitude Error Detection	76
Figure 30. Clock Monitor LRCLK Rate Error Example With CMON_ERRTOL = 0x1	77
Figure 31. Clock Monitor Framing Error Example In TDM Mode With PCM_BSEL = 0x6 and CMON_BSELTOL = 0x0	77
Figure 32. ICC Multi-Group Example with 2 Groups and 4 Total Devices	81
Figure 33. I <sup>2</sup> C Interface Timing Diagram	82
Figure 34. I <sup>2</sup> C START, STOP, and REPEATED START Conditions	83
Figure 35. I <sup>2</sup> C Acknowledge	83
Figure 36. I <sup>2</sup> C Writing One Byte of Data to the Slave	84
Figure 37. I <sup>2</sup> C Writing n-Bytes of Data to the Slave	84
Figure 38. I <sup>2</sup> C Reading One Byte of Data from the Slave	85

---

**LIST OF FIGURES (CONTINUED)**

---

Figure 39. I<sup>2</sup>C Reading n-Bytes of Data from the Slave ..... 85



---

**LIST OF TABLES**

---

Table 1. Typical Power-Up Sequence . . . . .	40
Table 2. Typical Power-Down Sequence . . . . .	40
Table 3. Sample Rate Selection for I/V Sense . . . . .	41
Table 4. Supported I <sup>2</sup> S/Left-Justified Mode Configurations . . . . .	42
Table 5. Supported TDM Mode Configurations . . . . .	43
Table 6. Supported PCM Data Output Types . . . . .	47
Table 7. Interrupt Sources . . . . .	50
Table 8. Noise Gate/Idle Mode Threshold LSB Location by Input Data Configuration . . . . .	53
Table 9. Brownout-Prevention Engine Levels . . . . .	72
Table 10. I <sup>2</sup> C Slave Address . . . . .	81
Table 11. Control Bit Types and Write Access Restrictions . . . . .	85
Table 12. Component List . . . . .	170

## Absolute Maximum Ratings

VBAT to PGND .....	-0.3V to +6.0V	All Other Digital Pins to DGND .....	-0.3V to $V_{DVDDIO} + 0.3V$
PVDD to PGND .....	-0.3V to +22V	Short-Circuit Duration Between OUTP, OUTN, and PGND or PVDD or VBAT .....	Continuous
PVDD to VBAT .....	-0.3V to $22 - V_{VBAT}$	Short Circuit Duration Between OUTP and OUTN .....	Continuous
AGND, DGND to PGND .....	-0.1V to +0.1V	Continuous Power Dissipation for Multilayer Board ( $T_A = +70^\circ C$ , derate 21.58mW/ $^\circ C$ above $+70^\circ C$ ) .....	mW to 1.73mW
AVDD to AGND .....	-0.3V to +2.2V	Junction Temperature .....	+150 $^\circ C$
DVDD, DVDDIO to DGND .....	-0.3V to +2.2V	Operating Temperature Range .....	-40 $^\circ C$ to +85 $^\circ C$
OUTP, OUTN to PGND .....	-0.3V to $V_{PVDD} + 0.3V$	Storage Temperature Range .....	-65 $^\circ C$ to +150 $^\circ C$
OUTPSNS or OUTNSNS to PGND .....	-0.3V to +22 V	Soldering Temperature (reflow) .....	+260 $^\circ C$
OUTPSNS and OUTNSNS to PGND .....	-0.3V to +13 V		
VREFC to GND .....	-0.3V to +5.5V		
I2C1, I2C2, ADDR to GND .....	-0.3V to +4.0V		

Stresses beyond those listed under "Absolute Maximum Ratings" may cause permanent damage to the device. These are stress ratings only, and functional operation of the device at these or any other conditions beyond those indicated in the operational sections of the specifications is not implied. Exposure to absolute maximum rating conditions for extended periods may affect device reliability.

## Package Information

### 35 WLP

Package Code	W352F3Z+1
Outline Number	<a href="#">21-100489</a>
Land Pattern Number	Refer to <a href="#">Application Note 1891</a>
<b>Thermal Resistance, Single Layer Board:</b>	
Junction-to-Ambient ( $\theta_{JA}$ )	46.33
Junction-to-Case Thermal Resistance ( $\theta_{JC}$ )	N/A
<b>Thermal Resistance, Four Layer Board:</b>	
Junction-to-Ambient ( $\theta_{JA}$ )	
Junction-to-Case Thermal Resistance ( $\theta_{JC}$ )	N/A

For the latest package outline information and land patterns (footprints), go to [www.maximintegrated.com/packages](http://www.maximintegrated.com/packages). Note that a "+", "#", or "-" in the package code indicates RoHS status only. Package drawings may show a different suffix character, but the drawing pertains to the package regardless of RoHS status.

Package thermal resistances were obtained using the method described in JEDEC specification JESD51-7, using a four-layer board. For detailed information on package thermal considerations, refer to [www.maximintegrated.com/thermal-tutorial](http://www.maximintegrated.com/thermal-tutorial).

## Electrical Characteristics

( $V_{VBAT} = 5.0V$ ,  $V_{PVDD} = 19V$ ,  $V_{AVDD} = 1.8V$ ,  $V_{DVDD} = 1.2V$ ,  $V_{DVDDIO} = \overline{RESET} = 1.2V$ ,  $C_{VBAT} = 1 \times 10\mu F$ ,  $1 \times 0.1\mu F$ ,  $C_{PVDD} = 1 \times 220\mu F$ ,  $2 \times 10\mu F$ ,  $2 \times 0.1\mu F$ ,  $C_{AVDD} = 1\mu F$ ,  $C_{DVDD} = 1\mu F$ ,  $C_{DVDDIO} = 0.1\mu F$ ,  $C_{VREFC} = 1\mu F$ ,  $Z_{SPK} = \text{Open}$ ,  $f_s = 48kHz$ , AC Measurement Bandwidth = 20Hz to 22kHz,  $SPK\_GAIN\_MAX = 0xF$  (19dB), Data Width = 24-bit, DG Mode,  $T_A = T_{MIN}$  to  $T_{MAX}$  unless otherwise noted, Typical values are at  $T_A = +25^\circ C$ ) (Note 2)

PARAMETER	SYMBOL	CONDITIONS	MIN	TYP	MAX	UNITS
<b>POWER SUPPLIES</b>						
VBAT Power Supply Operating Voltage Range	$V_{VBAT}$		3.0		5.5	V
VBAT Voltage	$V_{VBAT}$	Device is functional but parametric performance is not guaranteed	2.3			V
PVDD Power Supply Operating Voltage Range	$V_{PVDD}$		3.0		20	V
PVDD Voltage	$V_{PVDD}$	Device is functional but parametric performance is not guaranteed	2.3			V
AVDD Power Supply Voltage Range	$V_{AVDD}$		1.71	1.8	1.89	V
DVDD Power Supply Voltage Range	$V_{DVDD}$		1.14	1.2	1.89	V
DVDDIO Power Supply Voltage Range	$V_{DVDDIO}$		1.14	1.2	1.26	V
			1.71	1.8	1.89	
VBAT Undervoltage Lockout	$V_{VBAT\_UVLO}$	$V_{VBAT}$ falling	1.8		2.2	V
PVDD Undervoltage Lockout	$V_{PVDD\_UVLO}$	$V_{PVDD}$ falling	1.93		2.26	V
AVDD Undervoltage Lockout	$V_{AVDD\_UVLO}$	$V_{AVDD}$ falling	1.24		1.46	V
DVDD Undervoltage Lockout	$V_{DVDD\_UVLO}$	$V_{DVDD}$ falling	0.85		1.01	V
VBAT UVLO Hysteresis		$T_A = +25^\circ C$	35			mV
PVDD UVLO Hysteresis		$T_A = +25^\circ C$	30			mV
Supply Ramp Rate VBAT			0.1		100	V/ms
Supply Ramp Rate PVDD			0.1		100	V/ms

**Electrical Characteristics (continued)**

(V<sub>VBAT</sub> = 5.0V, V<sub>PVDD</sub> = 19V, V<sub>AVDD</sub> = 1.8V, V<sub>DVDD</sub> = 1.2V, V<sub>DVDDIO</sub> =  $\overline{\text{RESET}}$  = 1.2V, C<sub>VBAT</sub> = 1x10μF, 1x0.1μF, C<sub>PVDD</sub> = 1x220μF, 2x10μF, 2x0.1μF, C<sub>AVDD</sub> = 1μF, C<sub>DVDD</sub> = 1μF, C<sub>DVDDIO</sub> = 0.1μF, C<sub>VREFC</sub> = 1μF, Z<sub>SPK</sub> = Open, f<sub>s</sub> = 48kHz, AC Measurement Bandwidth = 20Hz to 22kHz, SPK\_GAIN\_MAX = 0xF (19dB), Data Width = 24-bit, DG Mode, T<sub>A</sub> = T<sub>MIN</sub> to T<sub>MAX</sub> unless otherwise noted, Typical values are at T<sub>A</sub> = +25°C) (Note 2)

PARAMETER	SYMBOL	CONDITIONS	MIN	TYP	MAX	UNITS
<b>POWER CONSUMPTION / QUIESCENT POWER CONSUMPTION</b>						
Total Power Consumption	P <sub>Q</sub>	All supplies, IV sense enabled	V <sub>PVDD</sub> = 12V, V <sub>VBAT</sub> = 3.8V, DG mode	16.5	25	mW
			V <sub>PVDD</sub> = 19V, V <sub>VBAT</sub> = 5.0V, DG mode (Note 3)	22.3	30	
		All supplies, IV sense disabled	V <sub>PVDD</sub> = 12V, V <sub>VBAT</sub> = 3.8V, DG mode	12.7		
			V <sub>PVDD</sub> = 19V, V <sub>VBAT</sub> = 5.0V, DG mode	18		
Total Power Consumption	P <sub>Q</sub>	All supplies, IV sense disabled	V <sub>PVDD</sub> = 12V, V <sub>VBAT</sub> = 3.8V, DG mode, noise gate enabled	1.7		mW
			V <sub>PVDD</sub> = 19V, V <sub>VBAT</sub> = 5.0V, DG mode, noise gate enabled	1.9		
<b>POWER CONSUMPTION / SOFTWARE SHUTDOWN</b>						
VBAT Software Shutdown Supply Current	I <sub>SHDN_SW_VBAT</sub>	AT	VBAT = 3.8V, No BCLK/LRCLK/DIN transactions, T <sub>A</sub> = +25°C	0.3	5	μA
			VBAT = 3.8V, No BCLK/LRCLK/DIN transactions, T <sub>A</sub> = +85°C (Note 3)		15	
			VBAT = 5.0V, No BCLK/LRCLK/DIN transactions, T <sub>A</sub> = +25°C	0.4	5	
			VBAT = 5.0V, No BCLK/LRCLK/DIN transactions, T <sub>A</sub> = +85°C (Note 3)		15	
PVDD Software Shutdown Supply Current	I <sub>SHDN_SW_PVDD</sub>	DD	PVDD = 5.0V, No BCLK/LRCLK/DIN transactions, T <sub>A</sub> = +25°C	0.25	5	μA
			PVDD = 5.0V, No BCLK/LRCLK/DIN transactions, T <sub>A</sub> = +85°C (Note 3)		15	
			PVDD = 12V, No BCLK/LRCLK/DIN transactions, T <sub>A</sub> = +25°C	1	5	
			PVDD = 12V, No BCLK/LRCLK/DIN transactions, T <sub>A</sub> = +85°C (Note 3)		15	
			PVDD = 19V, No BCLK/LRCLK/DIN transactions, T <sub>A</sub> = +25°C	1.7	5	
			PVDD = 19V, No BCLK/LRCLK/DIN transactions, T <sub>A</sub> = +85°C (Note 3)		15	

## Electrical Characteristics (continued)

( $V_{VBAT} = 5.0V$ ,  $V_{PVDD} = 19V$ ,  $V_{AVDD} = 1.8V$ ,  $V_{DVDD} = 1.2V$ ,  $V_{DVDDIO} = \overline{RESET} = 1.2V$ ,  $C_{VBAT} = 1 \times 10\mu F$ ,  $1 \times 0.1\mu F$ ,  $C_{PVDD} = 1 \times 220\mu F$ ,  $2 \times 10\mu F$ ,  $2 \times 0.1\mu F$ ,  $C_{AVDD} = 1\mu F$ ,  $C_{DVDD} = 1\mu F$ ,  $C_{DVDDIO} = 0.1\mu F$ ,  $C_{VREFC} = 1\mu F$ ,  $Z_{SPK} = \text{Open}$ ,  $f_s = 48\text{kHz}$ , AC Measurement Bandwidth = 20Hz to 22kHz,  $SPK\_GAIN\_MAX = 0x F$  (19dB), Data Width = 24-bit, DG Mode,  $T_A = T_{MIN}$  to  $T_{MAX}$  unless otherwise noted, Typical values are at  $T_A = +25^\circ C$ ) (Note 2)

PARAMETER	SYMBOL	CONDITIONS	MIN	TYP	MAX	UNITS
AVDD Software Shutdown Supply Current	$I_{SHDN\_SW\_AVDD}$	No BCLK/LRCLK/DIN transactions, $T_A = +25^\circ C$		1.1	5	$\mu A$
		No BCLK/LRCLK/DIN transactions, $T_A = +85^\circ C$ (Note 3)			30	
DVDDIO+DVDD Software Shutdown Supply Current	$I_{SHDN\_SW\_DVDD\_DVDDIO}$	No BCLK/LRCLK/DIN transactions, $T_A = +25^\circ C$		6.6	15	$\mu A$
		No BCLK/LRCLK/DIN transactions, $T_A = +85^\circ C$ (Note 3)			18	
<b>POWER CONSUMPTION / HARDWARE SHUTDOWN</b>						
VBAT Hardware Shutdown Supply Current	$I_{SHDN\_HW\_VBAT}$	$VBAT = 3.8V$ , $T_A = +25^\circ C$		0.3	5	$\mu A$
		$VBAT = 3.8V$ , $T_A = +85^\circ C$ (Note 3)			15	
		$VBAT = 5.0V$ , $T_A = +25^\circ C$		0.4	5	
		$VBAT = 5.0V$ , $T_A = +85^\circ C$ (Note 3)			15	
PVDD Hardware Shutdown Supply Current	$I_{SHDN\_HW\_PVDD}$	$PVDD = 5.0V$ , $T_A = +25^\circ C$		0.25	5	$\mu A$
		$PVDD = 5.0V$ , $T_A = +85^\circ C$ (Note 3)			15	
		$PVDD = 12V$ , $T_A = +25^\circ C$		1	5	
		$PVDD = 12V$ , $T_A = +85^\circ C$ (Note 3)			15	
		$PVDD = 19V$ , $T_A = +25^\circ C$		1.7	5	
		$PVDD = 19V$ , $T_A = +85^\circ C$ (Note 3)			15	
AVDD Hardware Shutdown Supply Current	$I_{SHDN\_HW\_AVDD}$	$T_A = +25^\circ C$		0.1	1	$\mu A$
		$T_A = +85^\circ C$ (Note 3)			10	
DVDDIO+DVDD Hardware Shutdown Supply Current	$I_{SHDN\_HW\_DVDD\_DVDDIO}$	$T_A = +25^\circ C$		0.2	6.0	$\mu A$
		$T_A = +85^\circ C$ (Note 3)			10	
<b>TURN-ON/OFF TIME</b>						
Turn-On Time	$t_{ON}$	From EN bit set to 1 to full operation, volume ramp disabled (Note 4)		1.4	3	ms
		From EN bit set to 1 to full operation, volume ramp enabled (Note 4)		3	6	ms
		From SPK_EN bit set to 1 to full operation, EN = 1, volume ramp disabled		0.85		ms
Turn-Off Time	$t_{OFF}$	$T_A = +25^\circ C$ , From full operation, EN bit set to 0 to software shutdown, volume ramp disabled		20	100	$\mu s$
		From full operation, EN bit set to 0 to software shutdown, volume ramp enabled		2.3	6	ms
		From SPK_EN bit set to 0 to amplifier disabled, volume ramp disabled, EN = 1		20		$\mu s$

**Electrical Characteristics (continued)**

( $V_{VBAT} = 5.0V$ ,  $V_{PVDD} = 19V$ ,  $V_{AVDD} = 1.8V$ ,  $V_{DVDD} = 1.2V$ ,  $V_{DVDDIO} = \overline{RESET} = 1.2V$ ,  $C_{VBAT} = 1 \times 10\mu F$ ,  $1 \times 0.1\mu F$ ,  $C_{PVDD} = 1 \times 220\mu F$ ,  $2 \times 10\mu F$ ,  $2 \times 0.1\mu F$ ,  $C_{AVDD} = 1\mu F$ ,  $C_{DVDD} = 1\mu F$ ,  $C_{DVDDIO} = 0.1\mu F$ ,  $C_{VREFC} = 1\mu F$ ,  $Z_{SPK} = \text{Open}$ ,  $f_s = 48\text{kHz}$ , AC Measurement Bandwidth = 20Hz to 22kHz,  $SPK\_GAIN\_MAX = 0xF$  (19dB), Data Width = 24-bit, DG Mode,  $T_A = T_{MIN}$  to  $T_{MAX}$  unless otherwise noted, Typical values are at  $T_A = +25^\circ C$ ) (Note 2)

PARAMETER	SYMBOL	CONDITIONS	MIN	TYP	MAX	UNITS
<b>DIGITAL AUDIO PATH</b>						
<b>DIGITAL AUDIO PATH / GAIN CONTROLS / DIGITAL VOLUME CONTROL</b>						
Digital Volume Control (max)	$A_{SPK\_VOL}$	$SPK\_VOL[6:0] = 0x00$		0		dB
Digital Volume Control Step Size				0.5		dB
Digital Volume Control (min)	$A_{SPK\_VOL}$	$SPK\_VOL[6:0] = 0x7E$		-63		dB
<b>DIGITAL AUDIO PATH / FILTERING / DIGITAL HIGHPASS FILTER CHARACTERISTICS (Note 5)</b>						
DC Attenuation			80			dB
DC Blocking Cut Off Frequency		$f_s = 8\text{kHz}, 16\text{kHz}, 32\text{kHz}$		0.856		Hz
				1.872		
<b>DIGITAL AUDIO PATH / FILTERING / DIGITAL FILTER CHARACTERISTICS (LRCLK &lt; 50kHz) (Note 5)</b>						
Valid Sample Rates			16		48	kHz
Passband Cutoff	$f_{PLP}$	Ripple < $\delta_p$	$0.454 \times f_s$			Hz
		Droop < -3dB	$0.459 \times f_s$			Hz
Passband Ripple	$\delta_p$	$f < f_{PLP}$ , referenced to signal level at 1kHz	-0.25		+0.25	dB
Stopband Cutoff	$f_{SLP}$	Attenuation > $\delta_s$			$0.49 \times f_s$	Hz
Stopband Attenuation	$\delta_s$	$f > f_{SLP}$	75			dB
Group Delay		$f = 1\text{kHz}$		6.1		Samples
<b>DIGITAL AUDIO PATH / FILTERING / DIGITAL FILTER CHARACTERISTICS (LRCLK &gt; 50kHz) (Note 5)</b>						
Valid Sample Rates			88.2		192	kHz
Passband Cutoff	$f_{PLP}$	SPK_WBAND_FIL $T_{EN} = 0$	Ripple < $\delta_p$ , $88.2\text{kHz} \leq f_s \leq 96\text{kHz}$	$0.227 \times f_s$		Hz
			Droop < -3dB, $88.2\text{kHz} \leq f_s \leq 96\text{kHz}$	$0.314 \times f_s$		Hz
	$f_{PLP}$		Ripple < $\delta_p$ , $176.4\text{kHz} \leq f_s \leq 192\text{kHz}$	$0.1135 \times f_s$		Hz
			Droop < -3dB cutoff, $176.4\text{kHz} \leq f_s \leq 192\text{kHz}$	$0.232 \times f_s$		Hz
Passband Ripple	$\delta_p$	SPK_WBAND_FIL $T_{EN} = 0$	$f < f_{PLP}$ , referenced to signal level at 1kHz	-0.25	+0.25	dB

**Electrical Characteristics (continued)**

( $V_{BAT} = 5.0V$ ,  $V_{PVDD} = 19V$ ,  $V_{AVDD} = 1.8V$ ,  $V_{DVDD} = 1.2V$ ,  $V_{DVDDIO} = \overline{RESET} = 1.2V$ ,  $C_{VBAT} = 1 \times 10\mu F$ ,  $1 \times 0.1\mu F$ ,  $C_{PVDD} = 1 \times 220\mu F$ ,  $2 \times 10\mu F$ ,  $2 \times 0.1\mu F$ ,  $C_{AVDD} = 1\mu F$ ,  $C_{DVDD} = 1\mu F$ ,  $C_{DVDDIO} = 0.1\mu F$ ,  $C_{VREFC} = 1\mu F$ ,  $Z_{SPK} = \text{Open}$ ,  $f_s = 48kHz$ , AC Measurement Bandwidth = 20Hz to 22kHz,  $SPK\_GAIN\_MAX = 0xF$  (19dB), Data Width = 24-bit, DG Mode,  $T_A = T_{MIN}$  to  $T_{MAX}$  unless otherwise noted, Typical values are at  $T_A = +25^\circ C$ ) (Note 2)

PARAMETER	SYMBOL	CONDITIONS		MIN	TYP	MAX	UNITS
Stopband Cutoff	$f_{SLP}$	SPK_WBAND_FIL T_EN = 0	Attenuation < $\delta_S$			$0.49 \times f_s$	Hz
Stopband Attenuation	$\delta_S$	SPK_WBAND_FIL T_EN = 0	$f > f_{SLP}$ , $88.2kHz \leq f_s \leq 96kHz$	80			dB
			$f > f_{SLP}$ , $176.4kHz \leq f_s \leq 192kHz$	65			
Group Delay		SPK_WBAND_FIL T_EN = 0	$f = 1kHz$		6.9		Samples
<b>DIGITAL AUDIO PATH / FILTERING / DIGITAL FILTER CHARACTERISTICS (LRCLK &gt; 50kHz) (Note 5)</b>							
Valid Sample Rates				88.2		192	kHz
Passband Cutoff	$f_{PLP}$	SPK_WBAND_FIL T_EN = 1	Ripple < $\delta_P$ , $88.2kHz \leq f_s \leq 96kHz$	$0.325 \times f_s$			Hz
			Droop < -3dB, $88.2kHz \leq f_s \leq 96kHz$	$0.463 \times f_s$			Hz
	$f_{PLP}$		Ripple < $\delta_P$ , $176.4kHz \leq f_s \leq 192kHz$	$0.18 \times f_s$			Hz
			Droop < -3dB cutoff, $176.4kHz \leq f_s \leq 192kHz$	$0.3 \times f_s$			Hz
Passband Ripple	$\delta_P$	SPK_WBAND_FIL T_EN = 1	$f < f_{PLP}$ , referenced to signal level at 1kHz	-0.35		+0.35	dB
Stopband Cutoff	$f_{SLP}$	SPK_WBAND_FIL T_EN = 1	Attenuation < $\delta_S$			$0.52 \times f_s$	Hz
Stopband Attenuation	$\delta_S$	SPK_WBAND_FIL T_EN = 1	$f > f_{SLP}$	77			dB
Group Delay		SPK_WBAND_FIL T_EN = 1	$f = 1kHz$		8.1		Samples
Max Device to Device Group Delay Variability		$f_{IN} = 1kHz$			1		$\mu s$
<b>CLASS-DG AMPLIFIER</b>							
Output Offset Voltage	$V_{OS}$	$T_A = +25^\circ C$ , $Z_{SPK} = 8\Omega + 33\mu H$ , DRE_EN = 0		-3	$\pm 0.65$	+3	mV
Click-and-Pop Level	$K_{CP}$	Peak voltage, audio playback silent, A-weighted, 32 samples per second, $T_A = +25^\circ C$ (Note 6)			-68		dBV
			$V_{PVDD} = 12V$		-68		

## Electrical Characteristics (continued)

( $V_{VBAT} = 5.0V$ ,  $V_{PVDD} = 19V$ ,  $V_{AVDD} = 1.8V$ ,  $V_{DVDD} = 1.2V$ ,  $V_{DVDDIO} = \overline{RESET} = 1.2V$ ,  $C_{VBAT} = 1x10\mu F$ ,  $1x0.1\mu F$ ,  $C_{PVDD} = 1x220\mu F$ ,  $2x10\mu F$ ,  $2x0.1\mu F$ ,  $C_{AVDD} = 1\mu F$ ,  $C_{DVDD} = 1\mu F$ ,  $C_{DVDDIO} = 0.1\mu F$ ,  $C_{VREFC} = 1\mu F$ ,  $Z_{SPK} = \text{Open}$ ,  $f_s = 48kHz$ , AC Measurement Bandwidth = 20Hz to 22kHz,  $SPK\_GAIN\_MAX = 0xF$  (19dB), Data Width = 24-bit, DG Mode,  $T_A = T_{MIN}$  to  $T_{MAX}$  unless otherwise noted, Typical values are at  $T_A = +25^\circ C$ ) (Note 2)

PARAMETER	SYMBOL	CONDITIONS	MIN	TYP	MAX	UNITS
Efficiency	$\eta_{SPK}$	$V_{PVDD} = 12V$ , $V_{VBAT} = 3.8V$ , $P_{OUT} = 1W$ , $Z_L = 8\Omega + 33\mu H$ , $f_{IN} = 1kHz$		87		%
	$\eta_{SPK}$	$V_{PVDD} = 12V$ , $V_{VBAT} = 3.8V$ , $P_{OUT} = 1W$ , $Z_L = 4\Omega + 33\mu H$ , $f_{IN} = 1kHz$		83		
	$\eta_{SPK}$	$V_{PVDD} = 19V$ , $V_{VBAT} = 5.0V$ , $P_{OUT} = 1W$ , $Z_L = 8\Omega + 33\mu H$ , $f_{IN} = 1kHz$		83		
	$\eta_{SPK}$	$V_{PVDD} = 19V$ , $V_{VBAT} = 5.0V$ , $P_{OUT} = 20W$ , $Z_L = 8\Omega + 33\mu H$ , $f_{IN} = 1kHz$		91		
Output Power	$P_{OUT}$	$V_{PVDD} = 12V$ , $Z_L = 4\Omega + 33\mu H$ , $THD+N \leq 1\%$ , $f_{IN} = 1kHz$		14		W
		$V_{PVDD} = 19V$ , $Z_L = 8\Omega + 33\mu H$ , $THD+N \leq 1\%$ , $f_{IN} = 1kHz$		20		
		$V_{PVDD} = 14V$ , $Z_L = 4\Omega + 33\mu H$ , $THD+N \leq 1\%$ , $f_{IN} = 1kHz$		19		
		$V_{PVDD} = 12V$ , $Z_L = 4\Omega + 33\mu H$ , $THD+N \leq 10\%$ , $f_{IN} = 1kHz$		17.8		
		$V_{PVDD} = 19V$ , $Z_L = 8\Omega + 33\mu H$ , $THD+N \leq 10\%$ , $f_{IN} = 1kHz$		25		
Peak Output Power	$P_{OUT}$	$Z_L = 4\Omega + 33\mu H$ ; 50Hz (2 period, peak signal)/1kHz (460 periods, low amplitude signal) alternating signal; crest factor = 12dB; test duration = 1min with $T_J < 100^\circ C$ and $THD+N < 1\%$		60		W
Total Harmonic Distortion + Noise	THD+N	$f_{IN} = 1kHz$ , $P_{OUT} = 1W$ , $Z_L = 8\Omega + 33\mu H$		-80		dB
		$f_{IN} = 1kHz$ , $P_{OUT} = 2W$ , $Z_L = 4\Omega + 33\mu H$		-80		
		$f_{IN} = 6kHz$ , $P_{OUT} = 1W$ , $Z_L = 8\Omega + 33\mu H$		-75		
		$f_{IN} = 6kHz$ , $P_{OUT} = 2W$ , $Z_L = 4\Omega + 33\mu H$		-73		
		$V_{PVDD} = 12V$	$f_{IN} = 1kHz$ , $P_{OUT} = 1W$ , $Z_L = 8\Omega + 33\mu H$	-75	-82	
			$f_{IN} = 1kHz$ , $P_{OUT} = 2W$ , $Z_L = 4\Omega + 33\mu H$		-80	
			$f_{IN} = 6kHz$ , $P_{OUT} = 1W$ , $Z_L = 8\Omega + 33\mu H$		-76	
		$V_{PVDD} = 14V$	$f_{IN} = 6kHz$ , $P_{OUT} = 2W$ , $Z_L = 4\Omega + 33\mu H$		-74	
Intermodulation Distortion		ITU-R standard, $f_{IN} = 19kHz/20kHz$ , $V_{IN} = -3dBFS$		-79		dB
Output Noise	$e_N$	A-weighted		15.5		$\mu V_{RMS}$



## Electrical Characteristics (continued)

( $V_{VBAT} = 5.0V$ ,  $V_{PVDD} = 19V$ ,  $V_{AVDD} = 1.8V$ ,  $V_{DVDD} = 1.2V$ ,  $V_{DVDDIO} = \overline{RESET} = 1.2V$ ,  $C_{VBAT} = 1x10\mu F$ ,  $1x0.1\mu F$ ,  $C_{PVDD} = 1x220\mu F$ ,  $2x10\mu F$ ,  $2x0.1\mu F$ ,  $C_{AVDD} = 1\mu F$ ,  $C_{DVDD} = 1\mu F$ ,  $C_{DVDDIO} = 0.1\mu F$ ,  $C_{VREFC} = 1\mu F$ ,  $Z_{SPK} = \text{Open}$ ,  $f_s = 48kHz$ , AC Measurement Bandwidth = 20Hz to 22kHz,  $SPK\_GAIN\_MAX = 0xF$  (19dB), Data Width = 24-bit, DG Mode,  $T_A = T_{MIN}$  to  $T_{MAX}$  unless otherwise noted, Typical values are at  $T_A = +25^\circ C$ ) (Note 2)

PARAMETER	SYMBOL	CONDITIONS	MIN	TYP	MAX	UNITS
Dynamic Range	DR	Measured using EIAJ method, -60dBFS output signal at 1kHz referenced to output power at 1%THD+N, A-weighted		118		dB
<b>CLASS-DG AMPLIFIER / POWER SUPPLY RIPPLE REJECTION</b>						
VBAT Supply Rejection DC	PSRR	$V_{VBAT} = 3.0V$ to $5.5V$	65	85		dB
VBAT Supply Rejection AC	PSRR	$V_{RIPPLE} = 100mV_{P-P}$	$f_{RIPPLE} = 217Hz$	78		dB
			$f_{RIPPLE} = 1kHz$	78		
			$f_{RIPPLE} = 20kHz$	64		
PVDD Supply DC Rejection	PSRR	$SPK\_MODE = 0x1$ (PVDD Mode) $V_{PVDD} = 3.0V$ to $20V$	60	90		dB
PVDD Supply Rejection AC	PSRR	$SPK\_MODE = 0x1$ (PVDD Mode), $V_{RIPPLE} = 100mV_{P-P}$	$f_{RIPPLE} = 217Hz$	80		dB
			$f_{RIPPLE} = 1kHz$	75		
			$f_{RIPPLE} = 20kHz$	60		
AVDD Supply DC Rejection	PSRR	$V_{AVDD} = 1.71V$ to $1.89V$	60	90		dB
AVDD Supply Rejection AC	PSRR	$V_{RIPPLE} = 100mV_{P-P}$	$f_{RIPPLE} = 217Hz$	90		dB
			$f_{RIPPLE} = 1kHz$	90		
			$f_{RIPPLE} = 20kHz$	70		
DVDD Supply DC Rejection	PSRR	$V_{DVDD} = 1.14V$ to $1.89V$		100		dB
DVDD Supply Rejection AC	PSRR	$V_{RIPPLE} = 100mV_{P-P}$	$f_{RIPPLE} = 217Hz$	95		dB
			$f_{RIPPLE} = 1kHz$	95		
			$f_{RIPPLE} = 20kHz$	95		
DVDDIO Supply DC Rejection	PSRR	$V_{DVDDIO} = 1.14V$ to $1.89V$		100		dB
DVDDIO Supply Rejection AC	PSRR	$V_{RIPPLE} = 100mV_{P-P}$	$f_{RIPPLE} = 217Hz$	95		dB
			$f_{RIPPLE} = 1kHz$	95		
			$f_{RIPPLE} = 20kHz$	95		
<b>CLASS-DG AMPLIFIER / POWER SUPPLY INTERMODULATION</b>						
Power Supply Intermodulation		$f_{IN} = 1kHz$ , $P_{OUT} = 400mW$	$V_{VBAT}$ , $f_{RIPPLE} = 217Hz$ , $V_{RIPPLE} = 100mV_{P-P}$	-78	-85	dB
			$V_{DVDD}$ , $f_{RIPPLE} = 217Hz$ , $V_{RIPPLE} = 100mV_{P-P}$		-100	
			$V_{DVDDIO}$ , $f_{RIPPLE} = 217Hz$ , $V_{RIPPLE} = 100mV_{P-P}$		-100	

## Electrical Characteristics (continued)

( $V_{BAT} = 5.0V$ ,  $V_{PVDD} = 19V$ ,  $V_{AVDD} = 1.8V$ ,  $V_{DVDD} = 1.2V$ ,  $V_{DVDDIO} = \overline{RESET} = 1.2V$ ,  $C_{VBAT} = 1 \times 10\mu F$ ,  $1 \times 0.1\mu F$ ,  $C_{PVDD} = 1 \times 220\mu F$ ,  $2 \times 10\mu F$ ,  $2 \times 0.1\mu F$ ,  $C_{AVDD} = 1\mu F$ ,  $C_{DVDD} = 1\mu F$ ,  $C_{DVDDIO} = 0.1\mu F$ ,  $C_{VREFC} = 1\mu F$ ,  $Z_{SPK} = \text{Open}$ ,  $f_s = 48\text{kHz}$ , AC Measurement Bandwidth = 20Hz to 22kHz,  $SPK\_GAIN\_MAX = 0\text{xF}$  (19dB), Data Width = 24-bit, DG Mode,  $T_A = T_{MIN}$  to  $T_{MAX}$  unless otherwise noted, Typical values are at  $T_A = +25^\circ\text{C}$ ) (Note 2)

PARAMETER	SYMBOL	CONDITIONS	MIN	TYP	MAX	UNITS
Output Switching Frequency		Constant across all sample rates in the 48kHz family		472		kHz
		Constant across all sample rates in the 44.1kHz family		451		
Frequency Response Deviation		Across the bandwidth 20Hz to 20kHz referenced to $f_{IN} = 1\text{kHz}$ (Note 3)	-0.25		+0.25	dB
Gain Error	$A_{ERROR}$		-0.5		+0.5	dB
Channel-to-Channel Phase Error		Output phase shift between multiple devices from 20Hz to 20kHz, across all sample rates and DAI operating modes		1		°
Minimum Load Resistance				3.2		$\Omega$
Minimum Load Inductance		In series with a 3.2 $\Omega$ load		0		$\mu\text{H}$
Maximum Load Inductance		In series with a 3.2 $\Omega$ load		100		$\mu\text{H}$
Current Limit	$I_{LIM}$	PVDD mode	6.2	7		A
<b>SPEAKER VOLTAGE ADC</b>						
Resolution				16		Bits
Sample Rate	$f_{SVSNS\ ADC}$		8		192	kHz
Voltage Range	$V_{SPK}$			$\pm 22$		V
Dynamic Range	DNR	$f_{IN} = 1\text{kHz}$ , AC measurement bandwidth = 20Hz to 20kHz, unweighted		81		dB
Total Harmonic Distortion + Noise	THD+N	$f_{IN} = 1\text{kHz}$ , $V_{SPK} = 8\text{Vrms}$		-65		dB
DC Offset Voltage		DC blocking filter enabled	-0.2		+0.2	mV
		DC blocking filter disabled, $T_A = +25^\circ\text{C}$ (Note 3)	-10		+10	
Highpass Cutoff Frequency		-3dB limit across all sample rates			2	Hz
<b>SPEAKER VOLTAGE ADC / DIGITAL FILTER CHARACTERISTICS (<math>f_s &lt; 50\text{kHz}</math>) (Note 5)</b>						
Passband Ripple		$f_{IN} < f_{PLP}$ , referenced to signal level at 1kHz	-0.225		+0.225	dB
Lowpass Filter Cutoff Frequency	$f_{PLP}$	Droop < -3dB	$0.44 \times f_s$			Hz
Lowpass Filter Stopband Frequency	$f_{SLP}$	-40dB limit			$0.58 \times f_s$	Hz
Lowpass Filter Stopband Attenuation			40			dB
Group Delay		$f_{IN} = 1\text{kHz}$		8		Samples

## Electrical Characteristics (continued)

( $V_{VBAT} = 5.0V$ ,  $V_{PVDD} = 19V$ ,  $V_{AVDD} = 1.8V$ ,  $V_{DVDD} = 1.2V$ ,  $V_{DVDDIO} = \overline{RESET} = 1.2V$ ,  $C_{VBAT} = 1 \times 10\mu F$ ,  $1 \times 0.1\mu F$ ,  $C_{PVDD} = 1 \times 220\mu F$ ,  $2 \times 10\mu F$ ,  $2 \times 0.1\mu F$ ,  $C_{AVDD} = 1\mu F$ ,  $C_{DVDD} = 1\mu F$ ,  $C_{DVDDIO} = 0.1\mu F$ ,  $C_{VREFC} = 1\mu F$ ,  $Z_{SPK} = \text{Open}$ ,  $f_s = 48\text{kHz}$ , AC Measurement Bandwidth = 20Hz to 22kHz,  $SPK\_GAIN\_MAX = 0\text{xF}$  (19dB), Data Width = 24-bit, DG Mode,  $T_A = T_{MIN}$  to  $T_{MAX}$  unless otherwise noted, Typical values are at  $T_A = +25^\circ\text{C}$ ) (Note 2)

PARAMETER	SYMBOL	CONDITIONS	MIN	TYP	MAX	UNITS
<b>SPEAKER VOLTAGE ADC / DIGITAL FILTER CHARACTERISTICS (<math>f_s &gt; 50\text{kHz}</math>) (Note 5)</b>						
Passband Ripple		IVADC_WBAND_F ILT_EN = 0	$f_{IN} \leq f_{PLP}$ , referenced to signal level at 1kHz	-0.225	+0.225	dB
Lowpass Filter Cutoff Frequency	$f_{PLP}$	IVADC_WBAND_F ILT_EN = 0	Ripple $< \delta_p$ , $88.2\text{kHz} \leq f_s \leq$ 96kHz	0.26 x $f_s$		Hz
			Droop $< -3\text{dB}$ , $88.2\text{kHz} \leq f_s \leq$ 96kHz	0.31 x $f_s$		
	$f_{PLP}$		Ripple $< \delta_p$ , $176.4\text{kHz} \leq f_s \leq$ 192kHz	0.13 x $f_s$		
			Droop $< -3\text{dB}$ , $176.4\text{kHz} \leq f_s \leq$ 192kHz	0.189 x $f_s$		
Lowpass Filter Stopband Frequency	$f_{SLP}$	IVADC_WBAND_F ILT_EN = 0	-40dB limit		0.58 x $f_s$	Hz
Lowpass Filter Stopband Attenuation		IVADC_WBAND_FILT_EN = 0		40		dB
Group Delay		IVADC_WBAND_F ILT_EN = 0	$f_{IN} = 1\text{kHz}$		10	Samples
<b>SPEAKER VOLTAGE ADC / DIGITAL FILTER CHARACTERISTICS (<math>f_s &gt; 50\text{kHz}</math>) (Note 5)</b>						
Passband Ripple		IVADC_WBAND_F ILT_EN = 1	$f_{IN} \leq f_{PLP}$ , referenced to signal level at 1kHz	-0.5	+0.5	dB
Lowpass Filter Cutoff Frequency	$f_{PLP}$	IVADC_WBAND_F ILT_EN = 1	Ripple $< \delta_p$ , $88.2\text{kHz} \leq f_s \leq$ 96kHz	0.27 x $f_s$		Hz
			Droop $< -3\text{dB}$ , $88.2\text{kHz} \leq f_s \leq$ 96kHz	0.475 x $f_s$		
	$f_{PLP}$		Ripple $< \delta_p$ , $176.4\text{kHz} \leq f_s \leq$ 192kHz	0.13 x $f_s$		
			Droop $< -3\text{dB}$ , $176.4\text{kHz} \leq f_s \leq$ 192kHz	0.31 x $f_s$		
Lowpass Filter Stopband Frequency	$f_{SLP}$	IVADC_WBAND_F ILT_EN = 1	-40dB limit		0.58 x $f_s$	Hz
Lowpass Filter Stopband Attenuation		IVADC_WBAND_FILT_EN = 1		40		dB

**Electrical Characteristics (continued)**

( $V_{VBAT} = 5.0V$ ,  $V_{PVDD} = 19V$ ,  $V_{AVDD} = 1.8V$ ,  $V_{DVDD} = 1.2V$ ,  $V_{DVDDIO} = \overline{RESET} = 1.2V$ ,  $C_{VBAT} = 1 \times 10\mu F$ ,  $1 \times 0.1\mu F$ ,  $C_{PVDD} = 1 \times 220\mu F$ ,  $2 \times 10\mu F$ ,  $2 \times 0.1\mu F$ ,  $C_{AVDD} = 1\mu F$ ,  $C_{DVDD} = 1\mu F$ ,  $C_{DVDDIO} = 0.1\mu F$ ,  $C_{VREFC} = 1\mu F$ ,  $Z_{SPK} = \text{Open}$ ,  $f_s = 48\text{kHz}$ , AC Measurement Bandwidth = 20Hz to 22kHz,  $SPK\_GAIN\_MAX = 0xF$  (19dB), Data Width = 24-bit, DG Mode,  $T_A = T_{MIN}$  to  $T_{MAX}$  unless otherwise noted, Typical values are at  $T_A = +25^\circ C$ ) (Note 2)

PARAMETER	SYMBOL	CONDITIONS		MIN	TYP	MAX	UNITS
Group Delay		IVADC_WBAND_F ILT_EN = 1	$f_{IN} = 1\text{kHz}$		10		Samples
<b>SPEAKER CURRENT ADC</b>							
Resolution					16		Bits
Sample Rate	$f_{SISNS\ ADC}$			8		192	kHz
Current Range	$I_{SPK}$				$\pm 6.5$		A
Dynamic Range	DNR	$f_{IN} = 1\text{kHz}$ , AC measurement bandwidth = 20Hz to 20kHz, unweighted, referred to $4A_{PEAK}$			73.5		dB
Total Harmonic Distortion + Noise	THD+N	$f_{IN} = 1\text{kHz}$ , $I_{SPK} = 1A_{RMS}$			-55		dB
Highpass Cutoff Frequency		-3dB limit across all sample rates				2	Hz
DC Offset Current		DC blocking filter enabled, $T_A = +25^\circ C$		-0.12		+0.12	mA
		DC blocking filter disabled, $T_A = +25^\circ C$ (Note 3)		-3		+3	
<b>SPEAKER CURRENT ADC / DIGITAL FILTER CHARACTERISTICS (<math>f_s &lt; 50\text{ kHz}</math>) (Note 5)</b>							
Passband Ripple		$f_{IN} < f_{PLP}$ , referenced to signal level at 1kHz		-0.225		+0.225	dB
Lowpass Filter Cutoff Frequency	$f_{PLP}$	Droop < -3dB		$0.44 \times f_s$			Hz
Lowpass Filter Stopband Frequency	$f_{SLP}$	-40dB limit				$0.58 \times f_s$	Hz
Lowpass Filter Stopband Attenuation				40			dB
Group Delay		$f_{IN} = 1\text{kHz}$			8		Samples
<b>SPEAKER CURRENT ADC / DIGITAL FILTER CHARACTERISTICS (<math>f_s &gt; 50\text{ kHz}</math>) (Note 5)</b>							
Passband Ripple	$\delta_p$	IVADC_WBAND_F ILT_EN = 0	$f_{IN} \leq f_{PLP}$ , referenced to signal level at 1kHz	-0.225		+0.225	dB

## Electrical Characteristics (continued)

( $V_{VBAT} = 5.0V$ ,  $V_{PVDD} = 19V$ ,  $V_{AVDD} = 1.8V$ ,  $V_{DVDD} = 1.2V$ ,  $V_{DVDDIO} = \overline{RESET} = 1.2V$ ,  $C_{VBAT} = 1x10\mu F$ ,  $1x0.1\mu F$ ,  $C_{PVDD} = 1x220\mu F$ ,  $2x10\mu F$ ,  $2x0.1\mu F$ ,  $C_{AVDD} = 1\mu F$ ,  $C_{DVDD} = 1\mu F$ ,  $C_{DVDDIO} = 0.1\mu F$ ,  $C_{VREFC} = 1\mu F$ ,  $Z_{SPK} = \text{Open}$ ,  $f_s = 48kHz$ , AC Measurement Bandwidth = 20Hz to 22kHz,  $SPK\_GAIN\_MAX = 0xF$  (19dB), Data Width = 24-bit, DG Mode,  $T_A = T_{MIN}$  to  $T_{MAX}$  unless otherwise noted, Typical values are at  $T_A = +25^\circ C$ ) (Note 2)

PARAMETER	SYMBOL	CONDITIONS		MIN	TYP	MAX	UNITS
Lowpass Filter Cutoff Frequency	$f_{PLP}$	IVADC_WBAND_F ILT_EN = 0	Ripple < $\delta_p$ , 88.2kHz $\leq f_s \leq$ 96kHz	0.26 x $f_s$			Hz
			Droop < -3dB, 88.2kHz $\leq f_s \leq$ 96kHz	0.31 x $f_s$			
	$f_{PLP}$		Ripple < $\delta_p$ , 176.4kHz $\leq f_s \leq$ 192kHz	0.14 x $f_s$			
			Droop < -3dB, 176.4kHz $\leq f_s \leq$ 192kHz	0.189 x $f_s$			
Lowpass Filter Stopband Frequency	$f_{SLP}$	IVADC_WBAND_F ILT_EN = 0	-40dB limit			0.58 x $f_s$	Hz
Lowpass Filter Stopband Attenuation		IVADC_WBAND_FILT_EN = 0		40			dB
Group Delay		IVADC_WBAND_F ILT_EN = 0	$f_{IN} = 1kHz$		10		Samples
<b>SPEAKER CURRENT ADC / DIGITAL FILTER CHARACTERISTICS (<math>f_s &gt; 50kHz</math>) (Note 5)</b>							
Passband Ripple	$\delta_p$	IVADC_WBAND_F ILT_EN = 1	$f_{IN} \leq f_{PLP}$ , referenced to signal level at 1kHz	-0.5		+0.5	dB
Lowpass Filter Cutoff Frequency	$f_{PLP}$	IVADC_WBAND_F ILT_EN = 1	Ripple < $\delta_p$ , 88.2kHz $\leq f_s \leq$ 96kHz	0.315 x $f_s$			Hz
			Droop < -3dB, 88.2kHz $\leq f_s \leq$ 96kHz	0.475 x $f_s$			
	$f_{PLP}$		Ripple < $\delta_p$ , 176.4kHz $\leq f_s \leq$ 192kHz	0.145 x $f_s$			
			Droop < -3dB, 176.4kHz $\leq f_s \leq$ 192kHz	0.31 x $f_s$			
Lowpass Filter Stopband Frequency	$f_{SLP}$	IVADC_WBAND_F ILT_EN = 1	-40dB limit			0.58 x $f_s$	Hz
Lowpass Filter Stopband Attenuation		IVADC_WBAND_FILT_EN = 1		-40			dB
Group Delay		IVADC_WBAND_F ILT_EN = 1	$f_{IN} = 1kHz$		10		Samples
<b>MEASUREMENT ADC</b>							
PVDD Channel Input Voltage Range				2.5		22	V

**Electrical Characteristics (continued)**

( $V_{VBAT} = 5.0V$ ,  $V_{PVDD} = 19V$ ,  $V_{AVDD} = 1.8V$ ,  $V_{DVDD} = 1.2V$ ,  $V_{DVDDIO} = \overline{RESET} = 1.2V$ ,  $C_{VBAT} = 1 \times 10\mu F$ ,  $1 \times 0.1\mu F$ ,  $C_{PVDD} = 1 \times 220\mu F$ ,  $2 \times 10\mu F$ ,  $2 \times 0.1\mu F$ ,  $C_{AVDD} = 1\mu F$ ,  $C_{DVDD} = 1\mu F$ ,  $C_{DVDDIO} = 0.1\mu F$ ,  $C_{VREFC} = 1\mu F$ ,  $Z_{SPK} = \text{Open}$ ,  $f_s = 48\text{kHz}$ , AC Measurement Bandwidth = 20Hz to 22kHz,  $SPK\_GAIN\_MAX = 0\text{xF}$  (19dB), Data Width = 24-bit, DG Mode,  $T_A = T_{MIN}$  to  $T_{MAX}$  unless otherwise noted, Typical values are at  $T_A = +25^\circ\text{C}$ ) (Note 2)

PARAMETER	SYMBOL	CONDITIONS	MIN	TYP	MAX	UNITS
PVDD Channel Voltage Resolution				38.1		mV
PVDD Channel Measurement Accuracy		$T_A = +25^\circ\text{C}$	-150		+150	mV
VBAT Channel Input Voltage Range			2.5		5.5	V
VBAT Channel Voltage Resolution				19.04		mV
VBAT Channel Measurement Accuracy		$T_A = +25^\circ\text{C}$ , Note 3	-100		+100	mV
<b>BROWNOUT-PREVENTION ENGINE (BPE)</b>						
BPE Attack Delay Time to Gain Change				15.5		$\mu\text{s}$
BPE Attack Delay Time to Interrupt				7.1		$\mu\text{s}$
<b>THERMAL PROTECTION</b>						
Thermal Shutdown Trigger Point		THERMSHDN_THRESH = 0x64	140	150	160	$^\circ\text{C}$
<b>DIGITAL I/O / INPUT—DIN, BCLK, LRCLK, RESET, ICC</b>						
Input Voltage High	$V_{IH}$		$0.7 \times V_{DVDDIO}$			V
Input Voltage Low	$V_{IL}$		$0.3 \times V_{DVDDIO}$			V
Input Leakage Current			-1		+1	$\mu\text{A}$
Input Hysteresis	$V_{HYS}$		75			mV
Maximum Input Capacitance	$C_{IN}$		10			pF
Internal Pulldown Resistance	$R_{PD}$	BCLK, LRCLK, and ICC	3			M $\Omega$
<b>DIGITAL I/O / INPUT—I2C1, I2C2, ADDR</b>						
Input Voltage High	$V_{IH}$		$0.7 \times V_{DVDDIO}$			V
Input Voltage Low	$V_{IL}$		$0.3 \times V_{DVDDIO}$			V
Input Leakage Current		$T_A = +25^\circ\text{C}$ , input high	-1		+1	$\mu\text{A}$
Input Hysteresis	$V_{HYS}$		75			mV

**Electrical Characteristics (continued)**

( $V_{BAT} = 5.0V$ ,  $V_{PVDD} = 19V$ ,  $V_{AVDD} = 1.8V$ ,  $V_{DVDD} = 1.2V$ ,  $V_{DVDDIO} = \overline{RESET} = 1.2V$ ,  $C_{VBAT} = 1 \times 10\mu F$ ,  $1 \times 0.1\mu F$ ,  $C_{PVDD} = 1 \times 220\mu F$ ,  $2 \times 10\mu F$ ,  $2 \times 0.1\mu F$ ,  $C_{AVDD} = 1\mu F$ ,  $C_{DVDD} = 1\mu F$ ,  $C_{DVDDIO} = 0.1\mu F$ ,  $C_{VREFC} = 1\mu F$ ,  $Z_{SPK} = \text{Open}$ ,  $f_s = 48\text{kHz}$ , AC Measurement Bandwidth = 20Hz to 22kHz,  $SPK\_GAIN\_MAX = 0\text{dB}$  (19dB), Data Width = 24-bit, DG Mode,  $T_A = T_{MIN}$  to  $T_{MAX}$  unless otherwise noted, Typical values are at  $T_A = +25^\circ\text{C}$ ) (Note 2)

PARAMETER	SYMBOL	CONDITIONS	MIN	TYP	MAX	UNITS
Maximum Input Capacitance	$C_{IN}$			10		pF
<b>DIGITAL I/O / OPEN DRAIN OUTPUT—I2C1, I2C2, IRQ, LV_EN</b>						
Output Voltage Low	$V_{OL}$	$I_{SINK} = 3\text{mA}$			0.4	V
Output High Leakage Current	$I_{OH}$	$T_A = +25^\circ\text{C}$	-1		+1	$\mu\text{A}$
<b>DIGITAL I/O / PUSH-PULL OUTPUT—DOUT, ICC, IRQ</b>						
Output Voltage High	$V_{OH}$	$I_{OH} = 3\text{mA}$			$V_{DVDDIO} - 0.3$	V
Output Voltage Low	$V_{OL}$	$I_{OL} = 3\text{mA}$			0.3	V
Output Current	$I_{OH}$	Maximum-drive mode		8		mA
		High-drive mode		6		
		Normal-drive mode		4		
		Reduced-drive mode		2		
<b>PCM AUDIO INTERFACE TIMING</b>						
LRCLK Frequency Range	$f_{LRCLK}$	All DAI operating modes	16		192	kHz
BCLK Frequency Range	$f_{BCLK}$	I <sup>2</sup> S/left-justified modes	1.024		12.288	MHz
		TDM mode	1.024		24.576	
BCLK Duty Cycle	DC		45		55	%
BCLK Period	$t_{BCLK}$	I <sup>2</sup> S/left-justified only	80			ns
		TDM mode	40			
Maximum BCLK Input Low-Frequency Jitter		Maximum allowable jitter before a -20dBFS, 20kHz input has a 1dB reduction in THD+N, RMS jitter $\leq 40\text{kHz}$		0.2		ns
Maximum BCLK Input High-Frequency Jitter		Maximum allowable jitter before a -60dBFS, 20kHz input has a 1dB reduction in THD+N, RMS jitter $> 40\text{kHz}$		1		ns
<b>PCM AUDIO INTERFACE TIMING / INTERFACE TIMING</b>						
LRCLK to BCLK Active Edge Setup Time	$t_{SYNCSET}$		4			ns
LRCLK to BCLK Active Edge Hold Time	$t_{SYNHOLD}$		4			ns
DIN to BCLK Active Edge Setup Time	$t_{SETUP}$		4			ns
DIN to BCLK Active Edge Hold Time	$t_{HOLD}$		4			ns
DIN Frame Delay After LRCLK Edge		Measured in number of BCLK cycles, set by selected TDM mode	0		2	cycles

**Electrical Characteristics (continued)**

( $V_{VBAT} = 5.0V$ ,  $V_{PVDD} = 19V$ ,  $V_{AVDD} = 1.8V$ ,  $V_{DVDD} = 1.2V$ ,  $V_{DVDDIO} = \overline{RESET} = 1.2V$ ,  $C_{VBAT} = 1 \times 10\mu F$ ,  $1 \times 0.1\mu F$ ,  $C_{PVDD} = 1 \times 220\mu F$ ,  $2 \times 10\mu F$ ,  $2 \times 0.1\mu F$ ,  $C_{AVDD} = 1\mu F$ ,  $C_{DVDD} = 1\mu F$ ,  $C_{DVDDIO} = 0.1\mu F$ ,  $C_{VREFC} = 1\mu F$ ,  $Z_{SPK} = \text{Open}$ ,  $f_s = 48\text{kHz}$ , AC Measurement Bandwidth = 20Hz to 22kHz,  $SPK\_GAIN\_MAX = 0x F$  (19dB), Data Width = 24-bit, DG Mode,  $T_A = T_{MIN}$  to  $T_{MAX}$  unless otherwise noted, Typical values are at  $T_A = +25^\circ C$ ) (Note 2)

PARAMETER	SYMBOL	CONDITIONS	MIN	TYP	MAX	UNITS
<b>PCM AUDIO INTERFACE TIMING / INTERFACE TIMING / PCM DATA OUTPUT (DOUT)</b>						
BCLK Inactive Edge to DOUT Delay	$t_{CLKTX}$				14	ns
BCLK Active Edge to DOUT Hi-Z Delay	$t_{HIZ}$		4		18	ns
BCLK Inactive Edge to DOUT Active Delay	$t_{ACTV}$		0		14	ns
<b>PCM AUDIO INTERFACE TIMING / INTERFACE TIMING / INTERCHIP COMMUNICATION (ICC)</b>						
ICC to BCLK Active Edge Setup Time	$t_{SETUP}$		4			ns
ICC to BCLK Active Edge Hold Time	$t_{HOLD}$		4			ns
BCLK Inactive Edge to ICC Delay	$t_{CLKTX}$				14	ns
BCLK Active Edge to ICC Hi-Z Delay	$t_{HIZ}$		4		18	ns
BCLK Inactive Edge to ICC Active Delay	$t_{ACTV}$		0		14	ns
<b>I<sup>2</sup>C INTERFACE TIMING</b>						
Serial Clock Frequency	$f_{SCL}$				1000	kHz
Bus Free Time Between STOP and START Conditions	$t_{BUF}$		0.5			$\mu s$
Hold Time (Repeated) START Condition	$t_{HD,STA}$		0.26			$\mu s$
SCL Pulse-Width Low	$t_{LOW}$		0.5			$\mu s$
SCL Pulse-Width High	$t_{HIGH}$		0.26			$\mu s$
Setup Time for a Repeated START Condition	$t_{SU,STA}$		0.26			$\mu s$
Data Hold Time	$t_{HD,DAT}$		0		450	ns
Data Setup Time	$t_{SU,DAT}$		50			ns
SDA and SCL Receiving Rise Time	$t_R$		20		120	ns
SDA and SCL Receiving Fall Time	$t_F$				$20 \times V_{DVDDI} / 5.5V$	120 ns
SDA Transmitting Fall Time	$t_F$				$20 \times V_{DVDDI} / 5.5V$	120 ns



**Electrical Characteristics (continued)**

( $V_{VBAT} = 5.0V$ ,  $V_{PVDD} = 19V$ ,  $V_{AVDD} = 1.8V$ ,  $V_{DVDD} = 1.2V$ ,  $V_{DVDDIO} = \overline{RESET} = 1.2V$ ,  $C_{VBAT} = 1 \times 10\mu F$ ,  $1 \times 0.1\mu F$ ,  $C_{PVDD} = 1 \times 220\mu F$ ,  $2 \times 10\mu F$ ,  $2 \times 0.1\mu F$ ,  $C_{AVDD} = 1\mu F$ ,  $C_{DVDD} = 1\mu F$ ,  $C_{DVDDIO} = 0.1\mu F$ ,  $C_{VREFC} = 1\mu F$ ,  $Z_{SPK} = \text{Open}$ ,  $f_s = 48kHz$ , AC Measurement Bandwidth = 20Hz to 22kHz,  $SPK\_GAIN\_MAX = 0xF$  (19dB), Data Width = 24-bit, DG Mode,  $T_A = T_{MIN}$  to  $T_{MAX}$  unless otherwise noted, Typical values are at  $T_A = +25^\circ C$ ) (Note 2)

PARAMETER	SYMBOL	CONDITIONS	MIN	TYP	MAX	UNITS
Setup Time for STOP Condition	$t_{SU,STO}$		0.26			$\mu s$
Bus Capacitance	$C_B$				550	pF
Pulse Width of Suppressed Spike	$t_{SP}$		0		50	ns
<b>RESET TIMING</b>						
$\overline{RESET}$ Low	$t_{RESET\_LOW}$	Minimum low time for $\overline{RESET}$ to ensure device enters hardware shutdown		1		$\mu s$
Release from $\overline{RESET}$	$t_{I^2C\_READY}$	Time from $\overline{RESET} = 1$ to I <sup>2</sup> C communication available (software shutdown)			1.5	ms

**Note 1:** Package thermal resistances were obtained using the method described in JEDEC specification JESD51-7, using a four-layer board. For detailed information on package thermal considerations, refer to [www.maximintegrated.com/thermal-tutorial](http://www.maximintegrated.com/thermal-tutorial).

**Note 2:** 100% production tested at  $T_A = +25^\circ C$ . Specifications over temperature limits are guaranteed by design. Typical values are based on one sigma characterization data unless otherwise noted.

**Note 3:** Minimum and/or maximum limit is guaranteed by design and by statistical analysis of device characterization data. The specification is not guaranteed by production testing.

**Note 4:** Assumes device is fully programmed ( $SPK\_EN = 1$ ) and  $EN = 1$  is the last I<sup>2</sup>C write in the sequence.

**Note 5:** Digital filter performance is invariant over temperature and is production tested at  $T_A = +25^\circ C$ .

**Note 6:** Applies to all transitions in/out of full operation with noise gate enabled/disabled. Does not include state transitions due to fault conditions.

Typical Operating Characteristics

( $V_{BAT} = 5.0V$ ,  $V_{DVDD} = 1.2V$ ,  $DVDDIO = 1.2V$ ,  $V_{AVDD} = 1.8V$ ,  $V_{GND} = 0V$ ,  $V_{PGND} = 0V$ ,  $V_{PVDD} = 19V$ ,  $C_{VBAT} = 10\mu F + 0.1\mu F$ ,  $C_{PVDD} = 0.1\mu F + 10\mu F + 220\mu F$ ,  $C_{DVDDIO} = 0.1\mu F$ ,  $C_{DVDD} = 1\mu F$ ,  $C_{VAVDD} = 1\mu F$ ,  $C_{VREFC} = 1\mu F$ ,  $A_V = 19dB$ ,  $Z_{SPK} = \infty$  between OUTP and OUTN, AC Measurement Bandwidth = 20Hz to 20kHz,  $f_S = 48kHz$ , 24-bit data,  $f_{BCLK} = 3.072MHz$ . Typical values are at  $T_A = +25^\circ C$ )

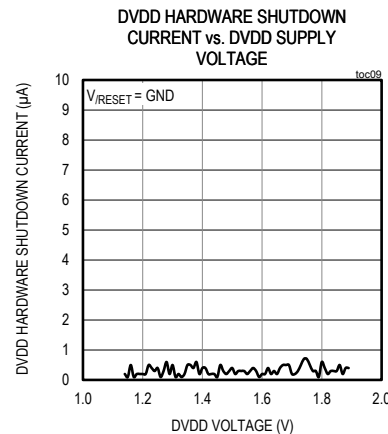
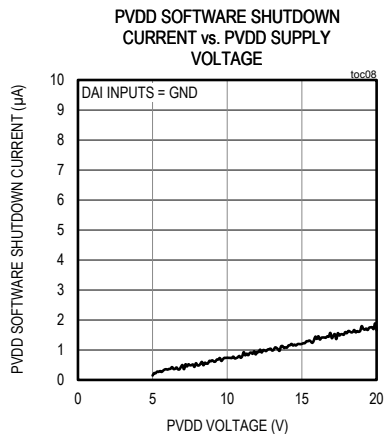
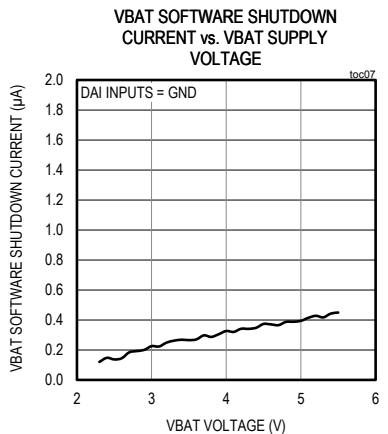
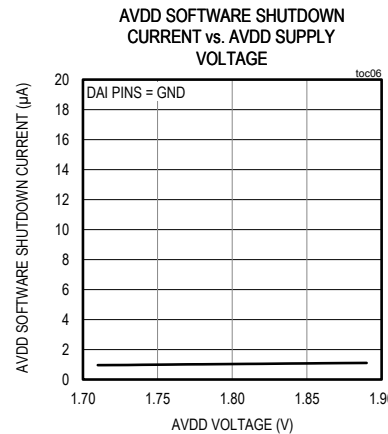
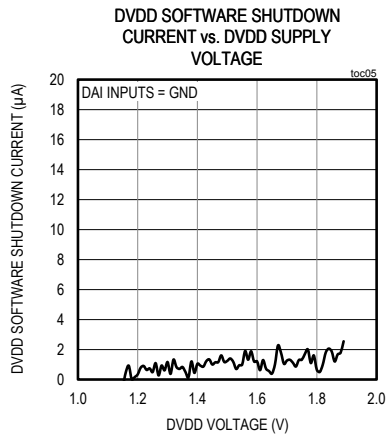
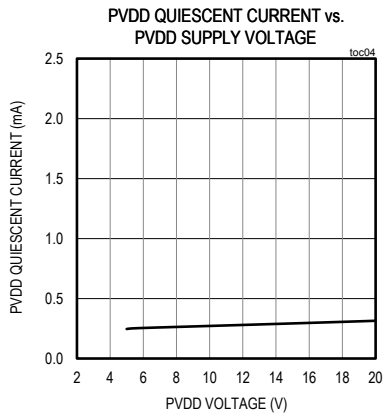
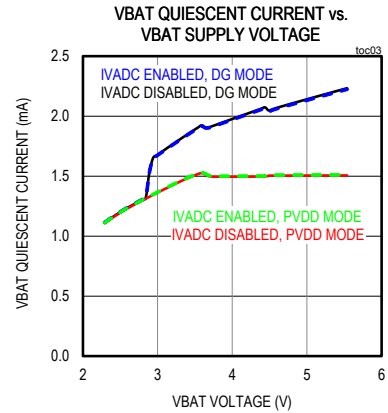
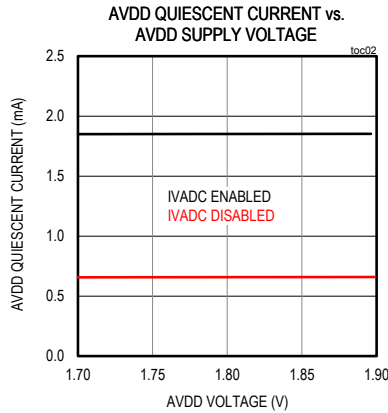
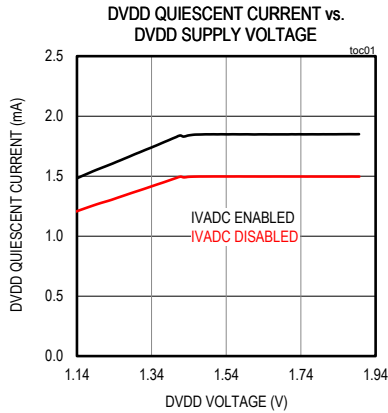

Typical Operating Characteristics (continued)

( $V_{VBAT} = 5.0V$ ,  $V_{DVDD} = 1.2V$ ,  $DVDDIO = 1.2V$ ,  $V_{AVDD} = 1.8V$ ,  $V_{GND} = 0V$ ,  $V_{PGND} = 0V$ ,  $V_{PVDD} = 19V$ ,  $C_{VBAT} = 10\mu F + 0.1\mu F$ ,  $C_{PVDD} = 0.1\mu F + 10\mu F + 220\mu F$ ,  $C_{DVDDIO} = 0.1\mu F$ ,  $C_{DVDD} = 1\mu F$ ,  $C_{VAVDD} = 1\mu F$ ,  $C_{VREFC} = 1\mu F$ ,  $A_V = 19dB$ ,  $Z_{SPK} = \infty$  between OUTP and OUTN, AC Measurement Bandwidth = 20Hz to 20kHz,  $f_S = 48kHz$ , 24-bit data,  $f_{BCLK} = 3.072MHz$ . Typical values are at  $T_A = +25^\circ C$ )

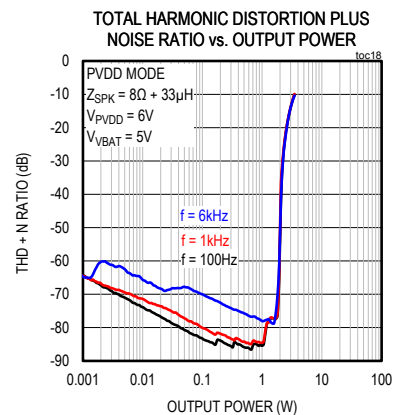
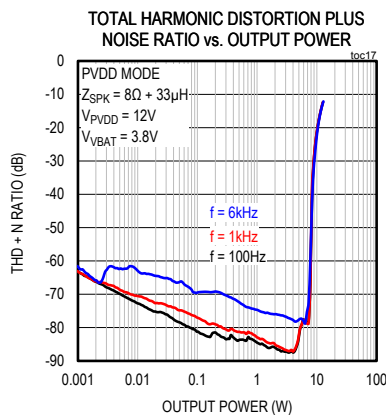
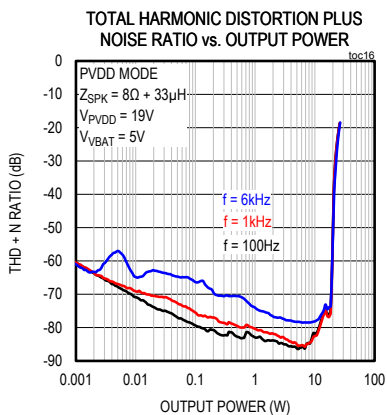
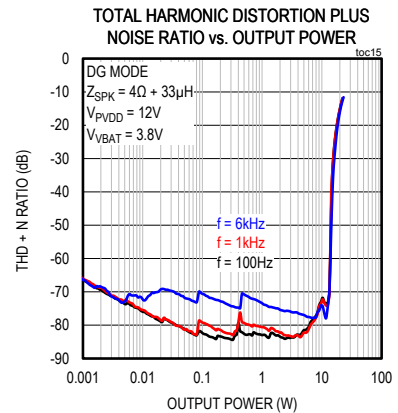
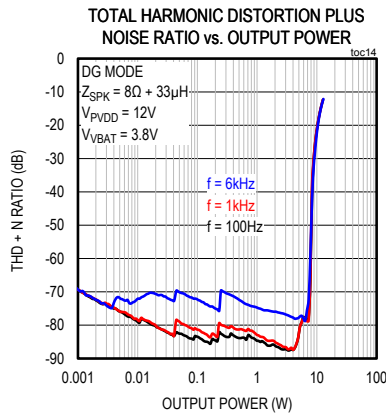
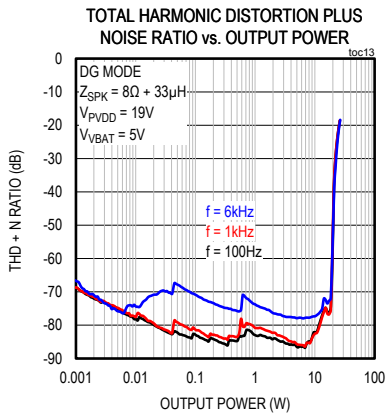
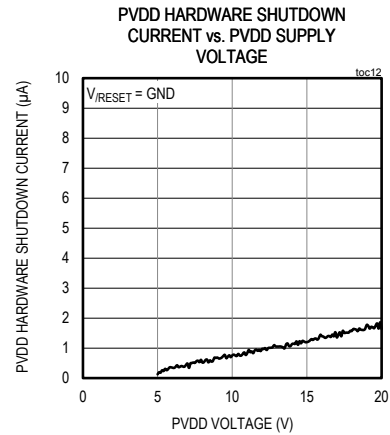
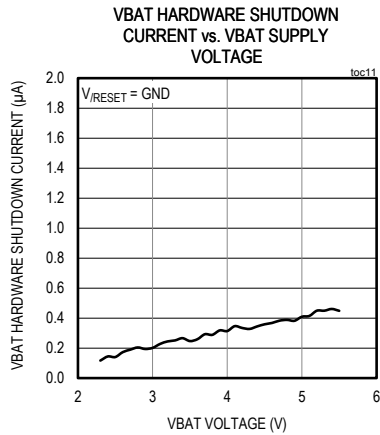
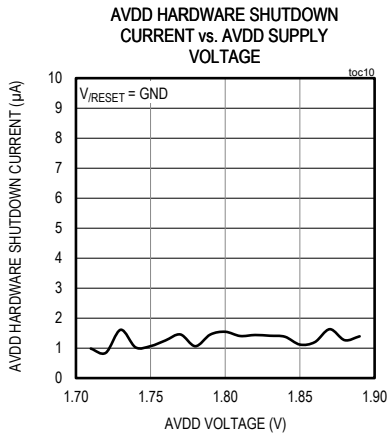

Typical Operating Characteristics (continued)

( $V_{VBAT} = 5.0V$ ,  $V_{DVDD} = 1.2V$ ,  $DVDDIO = 1.2V$ ,  $V_{AVDD} = 1.8V$ ,  $V_{GND} = 0V$ ,  $V_{PGND} = 0V$ ,  $V_{PVDD} = 19V$ ,  $C_{VBAT} = 10\mu F + 0.1\mu F$ ,  $C_{PVDD} = 0.1\mu F + 10\mu F + 220\mu F$ ,  $C_{DVDDIO} = 0.1\mu F$ ,  $C_{DVDD} = 1\mu F$ ,  $C_{VAVDD} = 1\mu F$ ,  $C_{VREFC} = 1\mu F$ ,  $A_V = 19dB$ ,  $Z_{SPK} = \infty$  between OUTP and OUTN, AC Measurement Bandwidth = 20Hz to 20kHz,  $f_S = 48kHz$ , 24-bit data,  $f_{BCLK} = 3.072MHz$ . Typical values are at  $T_A = +25^\circ C$ )

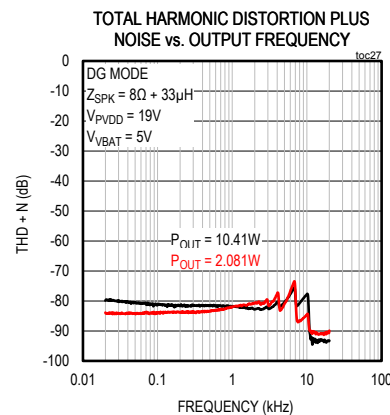
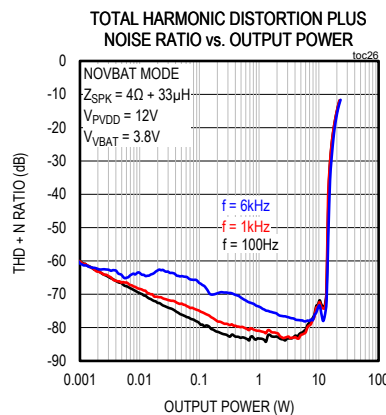
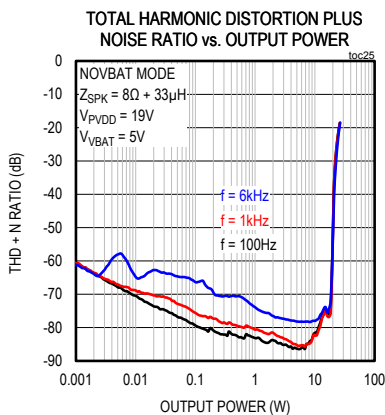
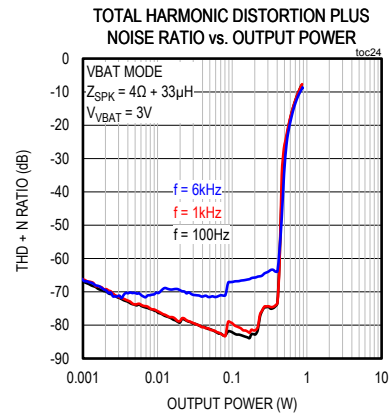
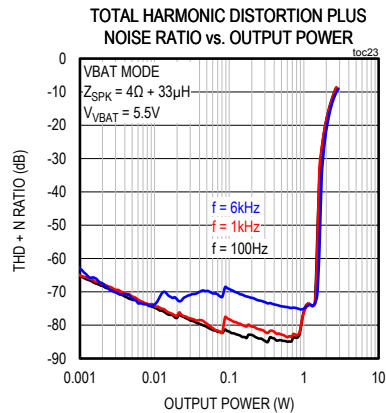
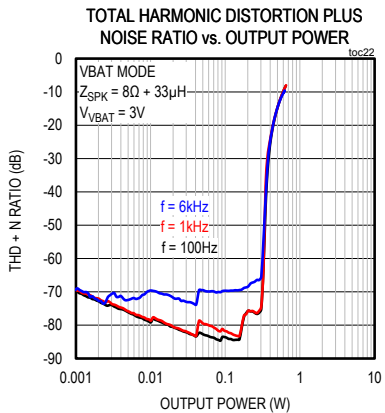
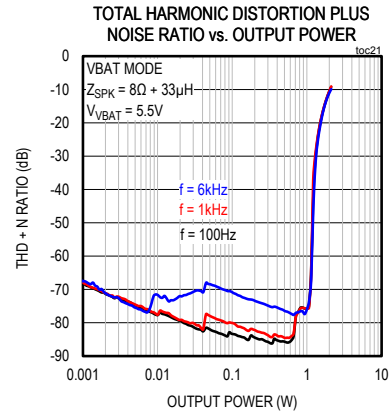
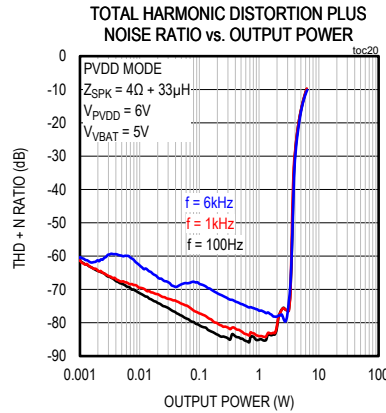
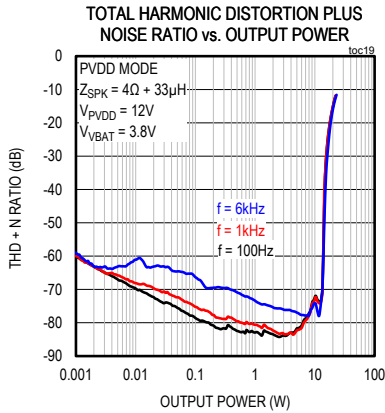

Typical Operating Characteristics (continued)

( $V_{VBAT} = 5.0V$ ,  $V_{DVDD} = 1.2V$ ,  $DVDDIO = 1.2V$ ,  $V_{AVDD} = 1.8V$ ,  $V_{GND} = 0V$ ,  $V_{PGND} = 0V$ ,  $V_{PVDD} = 19V$ ,  $C_{VBAT} = 10\mu F + 0.1\mu F$ ,  $C_{PVDD} = 0.1\mu F + 10\mu F + 220\mu F$ ,  $C_{DVDDIO} = 0.1\mu F$ ,  $C_{DVDD} = 1\mu F$ ,  $C_{VAVDD} = 1\mu F$ ,  $C_{VREFC} = 1\mu F$ ,  $A_V = 19dB$ ,  $Z_{SPK} = \infty$  between OUTP and OUTN, AC Measurement Bandwidth = 20Hz to 20kHz,  $f_S = 48kHz$ , 24-bit data,  $f_{BCLK} = 3.072MHz$ . Typical values are at  $T_A = +25^\circ C$ )

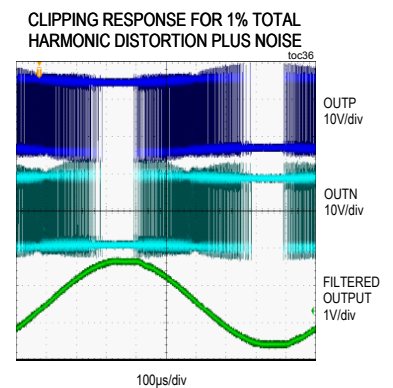
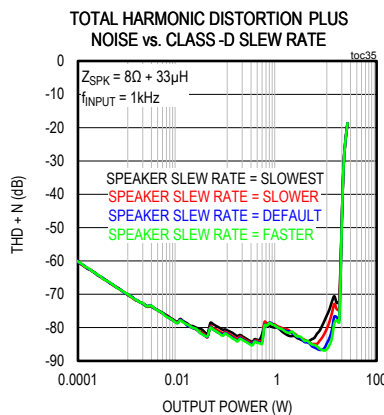
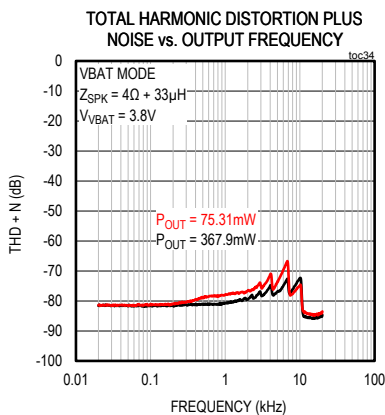
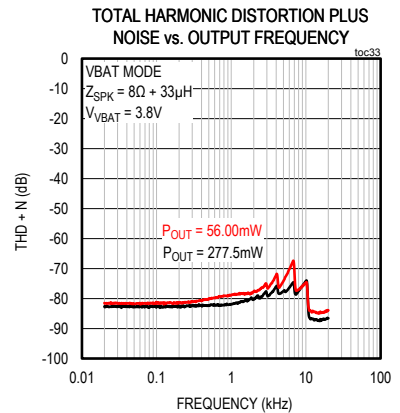
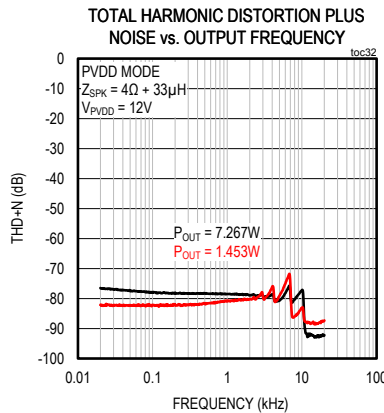
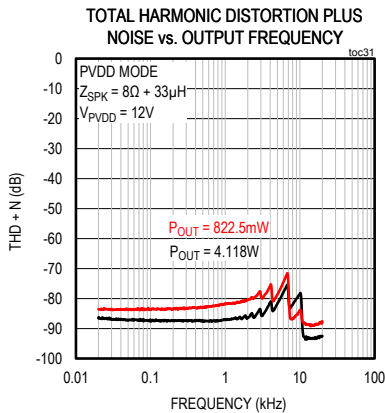
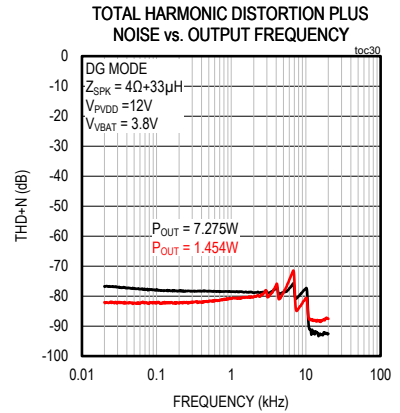
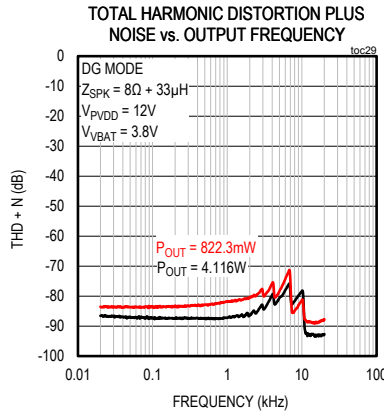
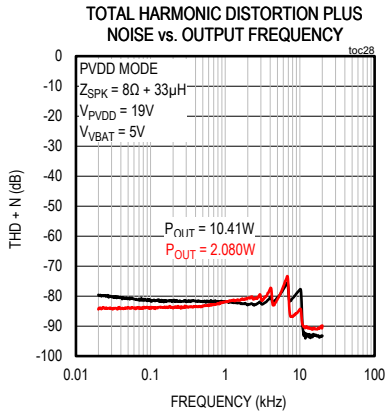

Typical Operating Characteristics (continued)

( $V_{BAT} = 5.0V$ ,  $V_{DVDD} = 1.2V$ ,  $DVDDIO = 1.2V$ ,  $V_{AVDD} = 1.8V$ ,  $V_{GND} = 0V$ ,  $V_{PGND} = 0V$ ,  $V_{PVDD} = 19V$ ,  $C_{VBAT} = 10\mu F + 0.1\mu F$ ,  $C_{PVDD} = 0.1\mu F + 10\mu F + 220\mu F$ ,  $C_{DVDDIO} = 0.1\mu F$ ,  $C_{DVDD} = 1\mu F$ ,  $C_{VAVDD} = 1\mu F$ ,  $C_{VREFC} = 1\mu F$ ,  $A_V = 19dB$ ,  $Z_{SPK} = \infty$  between OUTP and OUTN, AC Measurement Bandwidth = 20Hz to 20kHz,  $f_S = 48kHz$ , 24-bit data,  $f_{BCLK} = 3.072MHz$ . Typical values are at  $T_A = +25^\circ C$ )

CLIPPING RESPONSE FOR 10% TOTAL HARMONIC DISTORTION PLUS NOISE

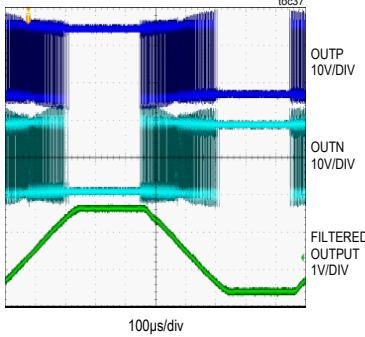

OUTPUT POWER vs. LOAD IMPEDANCE

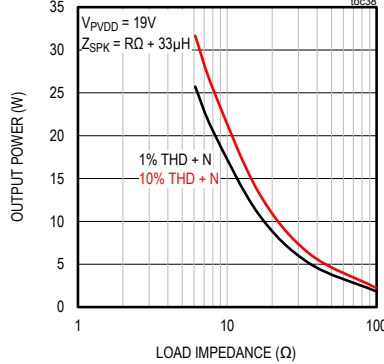

OUTPUT POWER vs. PVDD SUPPLY VOLTAGE

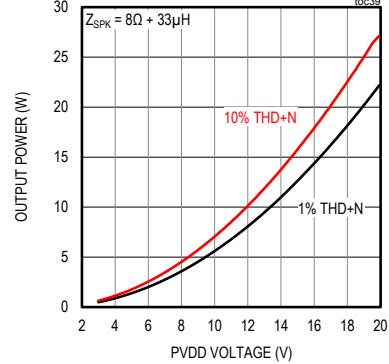

OUTPUT POWER vs. PVDD SUPPLY VOLTAGE

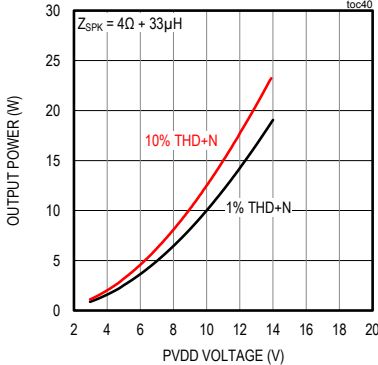

EFFICIENCY vs. OUTPUT POWER

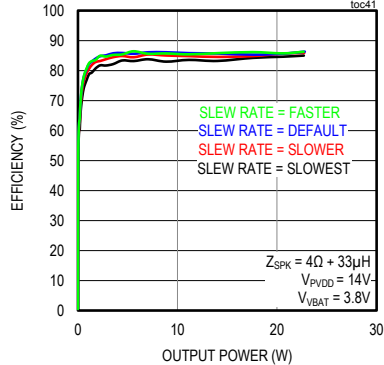

EFFICIENCY vs. OUTPUT POWER

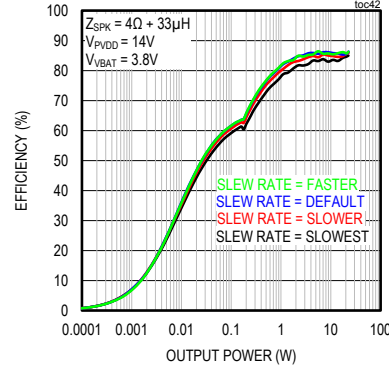

EFFICIENCY vs. OUTPUT POWER

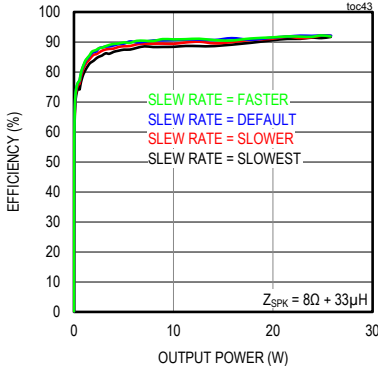

EFFICIENCY vs. OUTPUT POWER

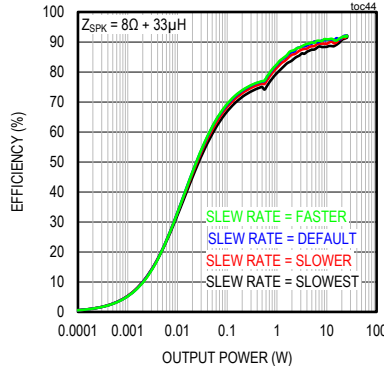

POWER DISSIPATION vs. OUTPUT POWER

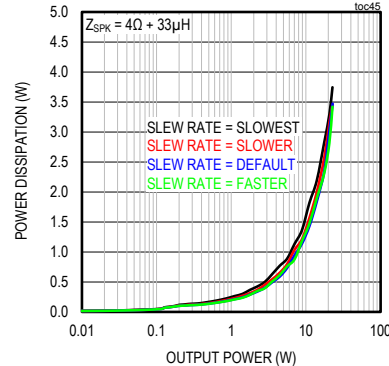

Typical Operating Characteristics (continued)

( $V_{BAT} = 5.0V$ ,  $V_{DVDD} = 1.2V$ ,  $DVDDIO = 1.2V$ ,  $V_{AVDD} = 1.8V$ ,  $V_{GND} = 0V$ ,  $V_{PGND} = 0V$ ,  $V_{PVDD} = 19V$ ,  $C_{VBAT} = 10\mu F + 0.1\mu F$ ,  $C_{PVDD} = 0.1\mu F + 10\mu F + 220\mu F$ ,  $C_{DVDDIO} = 0.1\mu F$ ,  $C_{DVDD} = 1\mu F$ ,  $C_{VAVDD} = 1\mu F$ ,  $C_{VREFC} = 1\mu F$ ,  $A_V = 19dB$ ,  $Z_{SPK} = \infty$  between OUTP and OUTN, AC Measurement Bandwidth = 20Hz to 20kHz,  $f_S = 48kHz$ , 24-bit data,  $f_{BCLK} = 3.072MHz$ . Typical values are at  $T_A = +25^\circ C$ )

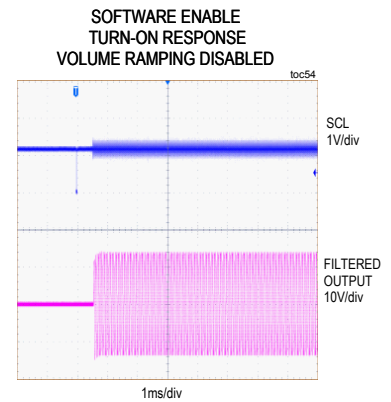
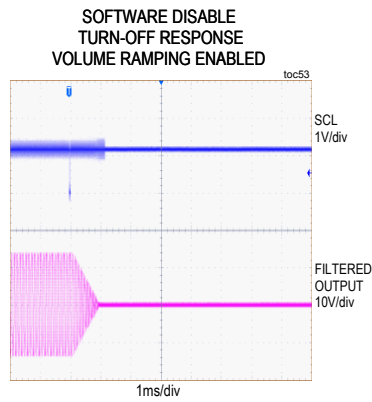
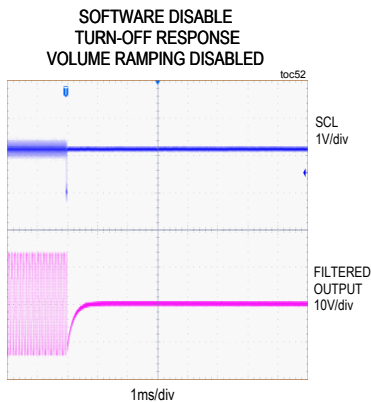
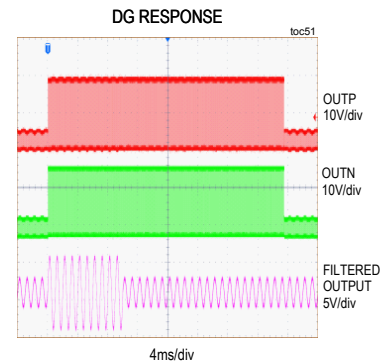
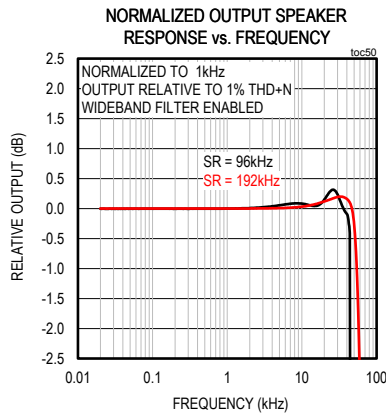
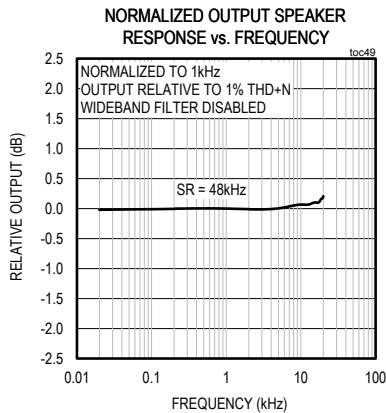
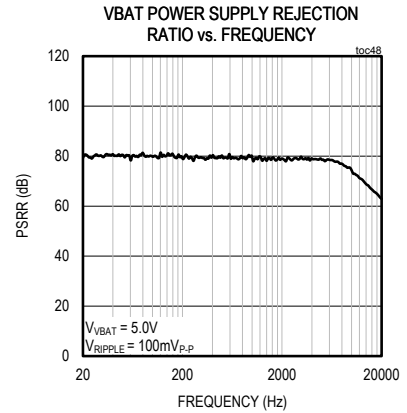
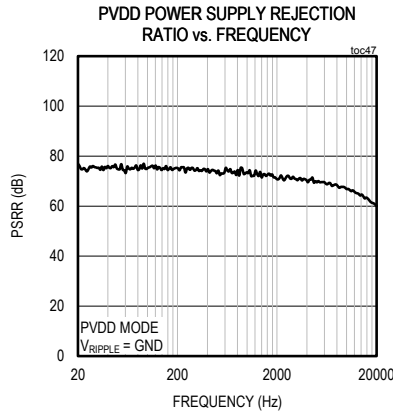
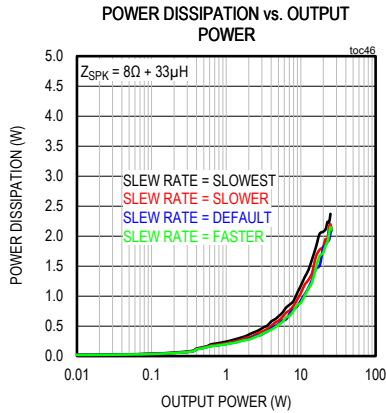

Typical Operating Characteristics (continued)

( $V_{BAT} = 5.0V$ ,  $V_{D VDD} = 1.2V$ ,  $D VDDIO = 1.2V$ ,  $V_{AVDD} = 1.8V$ ,  $V_{GND} = 0V$ ,  $V_{PGND} = 0V$ ,  $V_{PVDD} = 19V$ ,  $C_{VBAT} = 10\mu F + 0.1\mu F$ ,  $C_{PVDD} = 0.1\mu F + 10\mu F + 220\mu F$ ,  $C_{D VDDIO} = 0.1\mu F$ ,  $C_{D VDD} = 1\mu F$ ,  $C_{VAVDD} = 1\mu F$ ,  $C_{VREFC} = 1\mu F$ ,  $A_V = 19dB$ ,  $Z_{SPK} = \infty$  between OUTP and OUTN, AC Measurement Bandwidth = 20Hz to 20kHz,  $f_S = 48kHz$ , 24-bit data,  $f_{BCLK} = 3.072MHz$ . Typical values are at  $T_A = +25^\circ C$ )

SOFTWARE ENABLE  
TURN-ON RESPONSE  
VOLUME RAMPING ENABLED

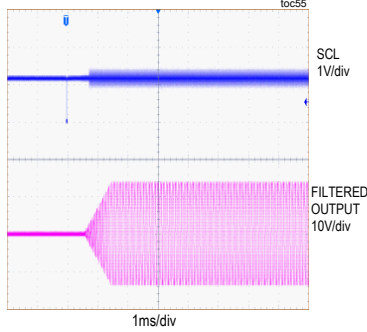

HARDWARE RESET TURN-OFF  
RESPONSE

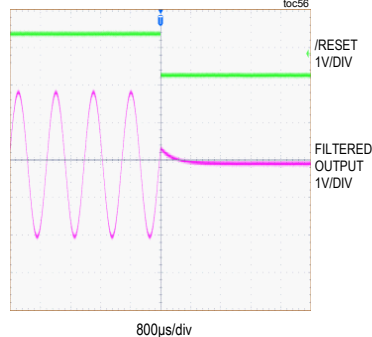

LARGE SIGNAL  
INBAND OUTPUT SPECTRUM

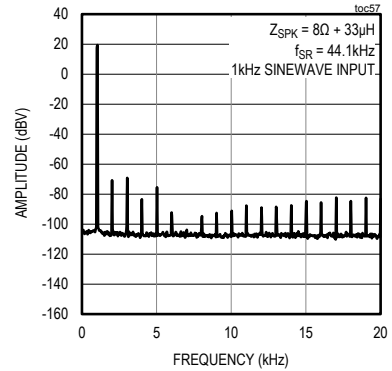

SMALL SIGNAL  
INBAND OUTPUT SPECTRUM

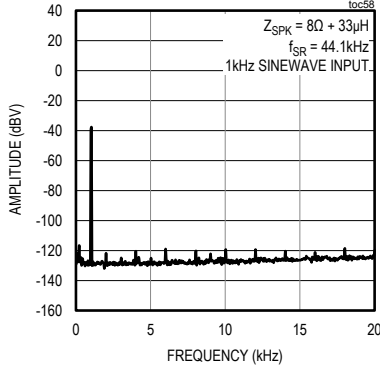

LARGE SIGNAL INBAND OUTPUT  
SPECTRUM

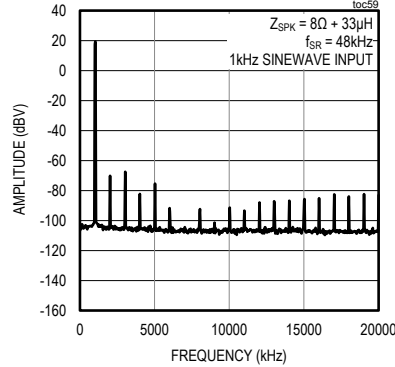

SMALL SIGNAL  
INBAND OUTPUT SPECTRUM

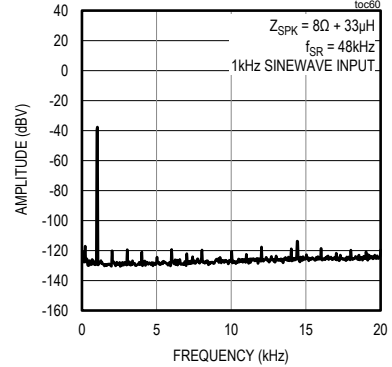

LARGE SIGNAL  
INBAND OUTPUT SPECTRUM

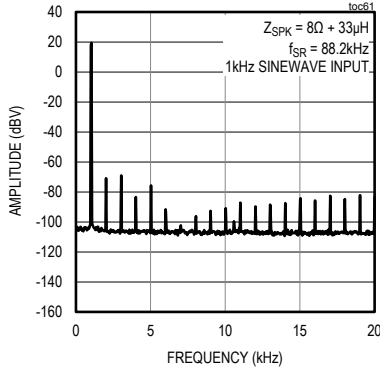

SMALL SIGNAL  
INBAND OUTPUT SPECTRUM

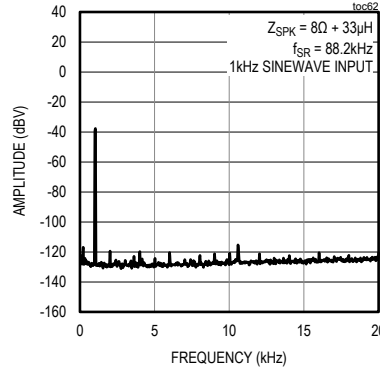

LARGE SIGNAL  
INBAND OUTPUT SPECTRUM

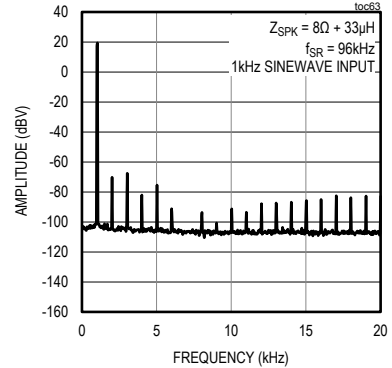



Typical Operating Characteristics (continued)

( $V_{BAT} = 5.0V$ ,  $V_{D V D D} = 1.2V$ ,  $D V D D I O = 1.2V$ ,  $V_{A V D D} = 1.8V$ ,  $V_{G N D} = 0V$ ,  $V_{P G N D} = 0V$ ,  $V_{P V D D} = 19V$ ,  $C_{V B A T} = 10\mu F + 0.1\mu F$ ,  $C_{P V D D} = 0.1\mu F + 10\mu F + 220\mu F$ ,  $C_{D V D D I O} = 0.1\mu F$ ,  $C_{D V D D} = 1\mu F$ ,  $C_{V A V D D} = 1\mu F$ ,  $C_{V R E F C} = 1\mu F$ ,  $A_V = 19dB$ ,  $Z_{S P K} = \infty$  between OUTP and OUTN, AC Measurement Bandwidth = 20Hz to 20kHz,  $f_S = 48kHz$ , 24-bit data,  $f_{B C L K} = 3.072MHz$ . Typical values are at  $T_A = +25^\circ C$ )

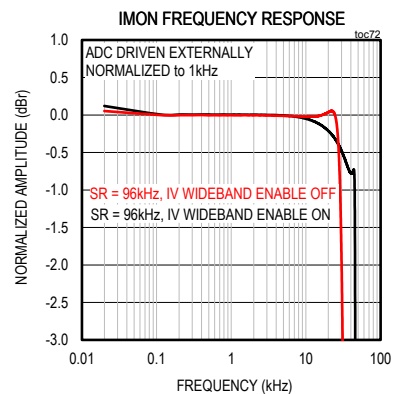
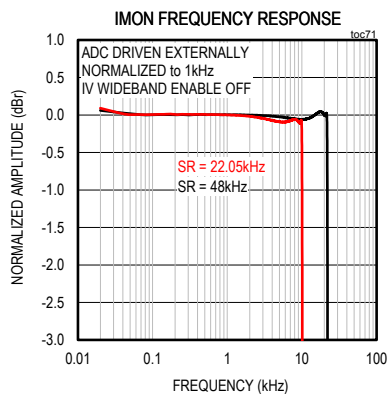
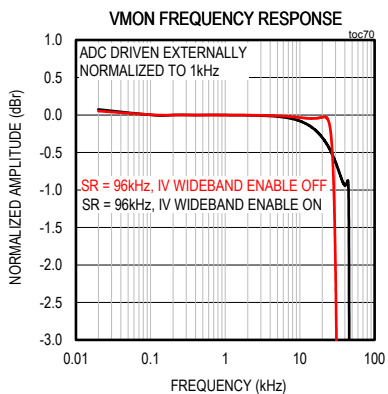
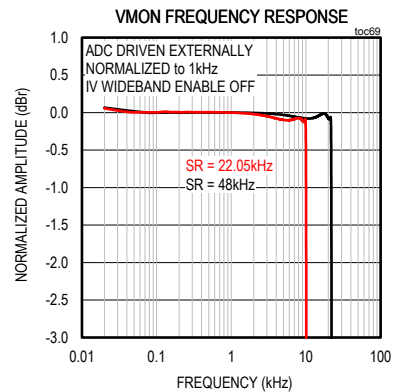
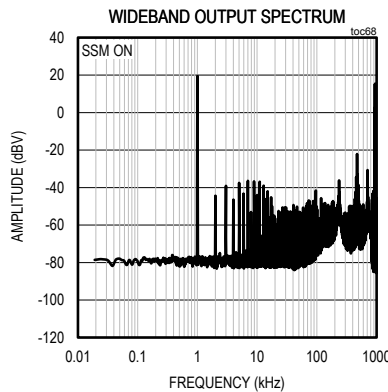
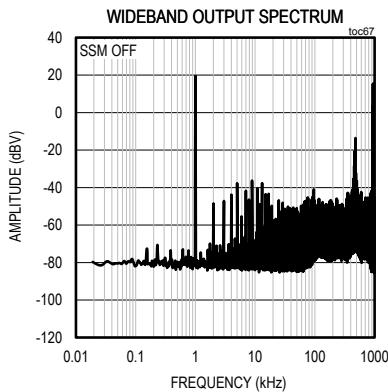
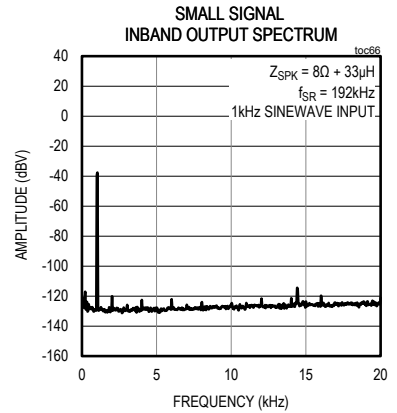
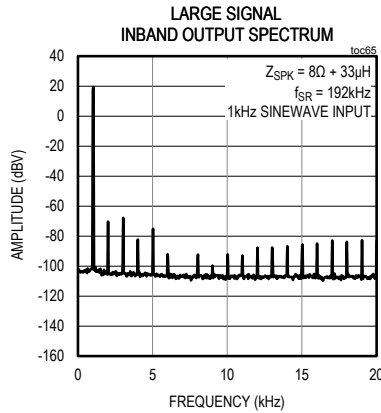
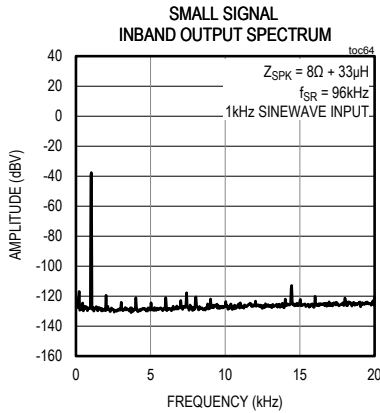

Typical Operating Characteristics (continued)

( $V_{BAT} = 5.0V$ ,  $V_{D VDD} = 1.2V$ ,  $D VDDIO = 1.2V$ ,  $V_{AVDD} = 1.8V$ ,  $V_{GND} = 0V$ ,  $V_{PGND} = 0V$ ,  $V_{PVDD} = 19V$ ,  $C_{VBAT} = 10\mu F + 0.1\mu F$ ,  $C_{PVDD} = 0.1\mu F + 10\mu F + 220\mu F$ ,  $C_{D VDDIO} = 0.1\mu F$ ,  $C_{D VDD} = 1\mu F$ ,  $C_{VAVDD} = 1\mu F$ ,  $C_{VREFC} = 1\mu F$ ,  $A_V = 19dB$ ,  $Z_{SPK} = \infty$  between OUTP and OUTN, AC Measurement Bandwidth = 20Hz to 20kHz,  $f_S = 48kHz$ , 24-bit data,  $f_{BCLK} = 3.072MHz$ . Typical values are at  $T_A = +25^\circ C$ )

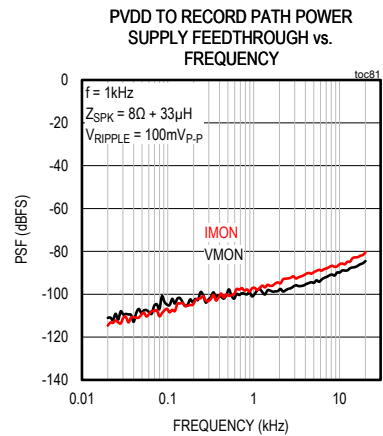
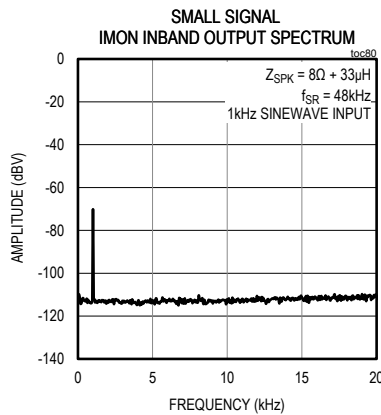
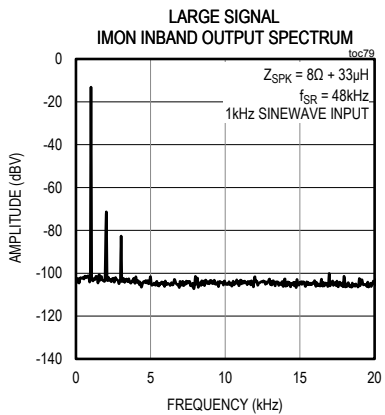
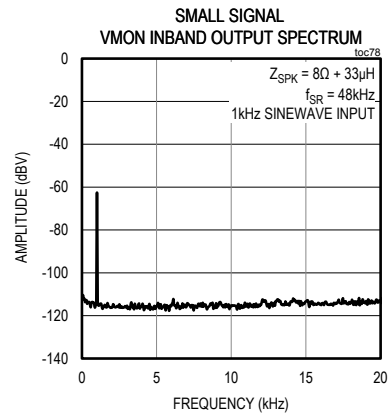
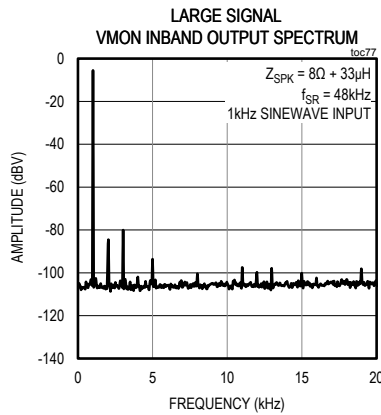
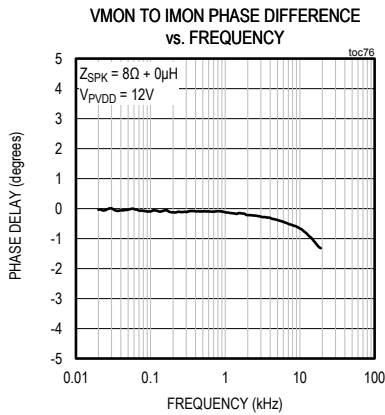
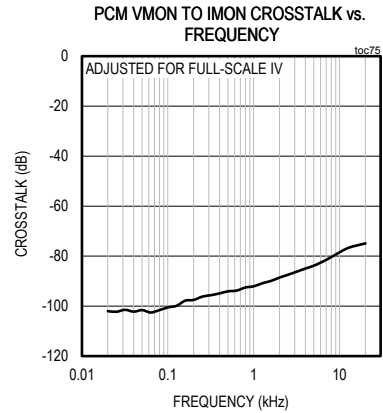
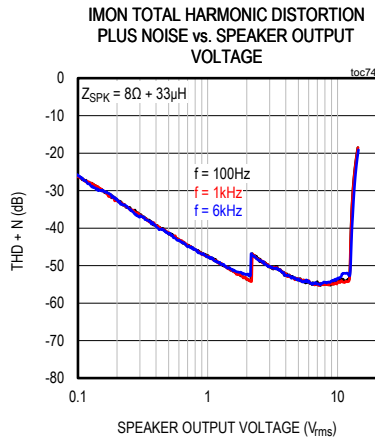
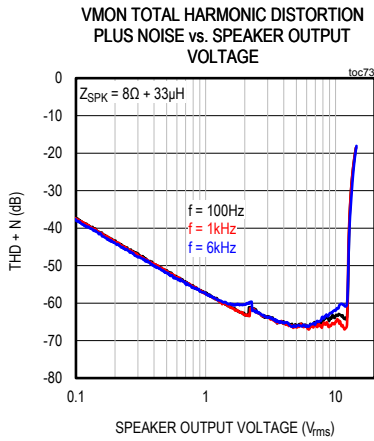

Typical Operating Characteristics (continued)

( $V_{BAT} = 5.0V$ ,  $V_{DVDD} = 1.2V$ ,  $DVDDIO = 1.2V$ ,  $V_{AVDD} = 1.8V$ ,  $V_{GND} = 0V$ ,  $V_{PGND} = 0V$ ,  $V_{PVDD} = 19V$ ,  $C_{VBAT} = 10\mu F + 0.1\mu F$ ,  $C_{PVDD} = 0.1\mu F + 10\mu F + 220\mu F$ ,  $C_{DVDDIO} = 0.1\mu F$ ,  $C_{DVDD} = 1\mu F$ ,  $C_{VAVDD} = 1\mu F$ ,  $C_{VREFC} = 1\mu F$ ,  $A_V = 19dB$ ,  $Z_{SPK} = \infty$  between OUP and OUTN, AC Measurement Bandwidth = 20Hz to 20kHz,  $f_S = 48kHz$ , 24-bit data,  $f_{BCLK} = 3.072MHz$ . Typical values are at  $T_A = +25^\circ C$ )

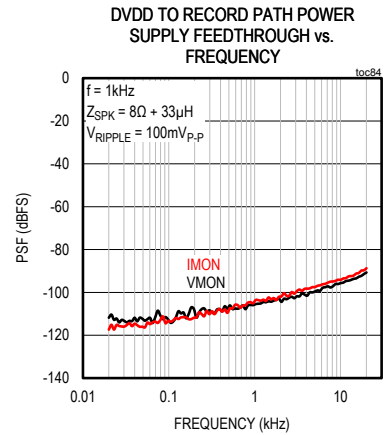
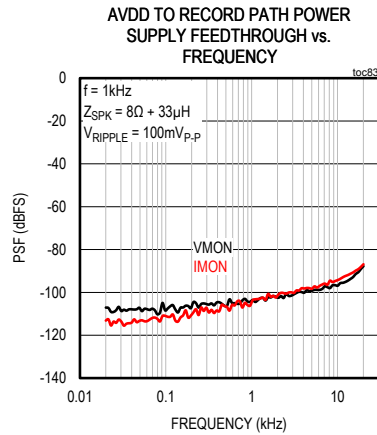
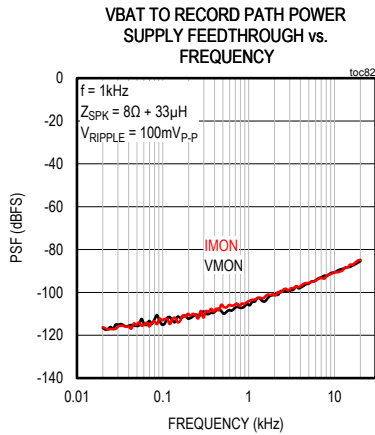

Pin Configuration

35 WLP

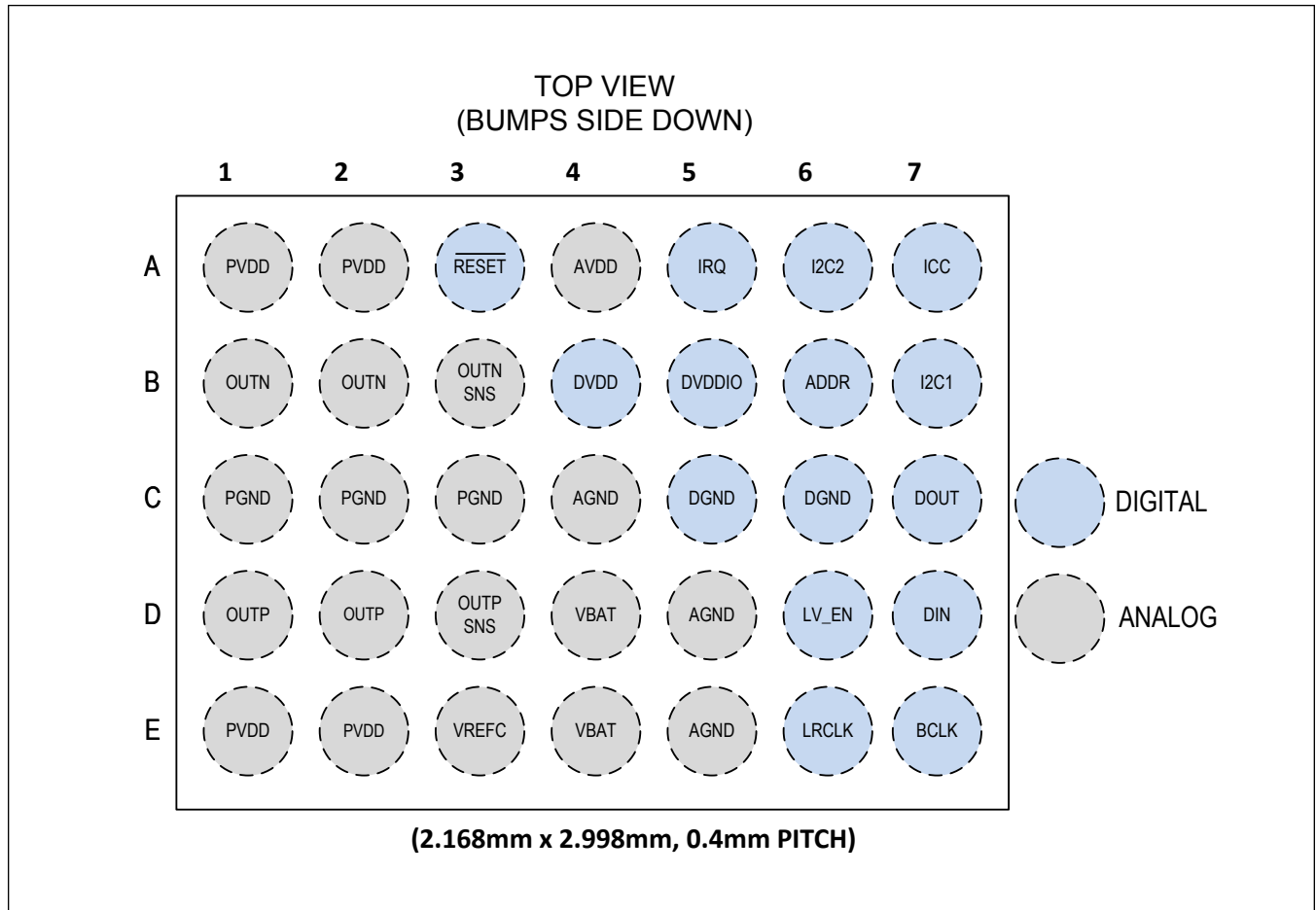

Pin Description

PIN	NAME	FUNCTION	REF SUPPLY	TYPE
B4	DVDD	Digital Core Power Supply. Bypass to GND with a 1µF capacitor.		Supply
B5	DVDDIO	Digital Core and Interface Power Supply. Bypass to DGND with a 0.1µF capacitor.		Supply
C5, C6	DGND	Digital Ground		Supply
A1, A2, E1, E2	PVDD	Speaker Amplifier Power Supply. Bypass each bump to PGND with a 0.1µF and 10µF capacitor placed as close as possible. Bypass the supply bus to PGND with a single 220µF bulk capacitor per device.		Supply
C1, C2, C3	PGND	Speaker Amplifier Ground		Supply
D4, E4	VBAT	Battery Power Supply. Bypass to PGND with a 0.1µF and 10µF capacitor placed as close as possible.		Supply

## Pin Description (continued)

PIN	NAME	FUNCTION	REF SUPPLY	TYPE
A4	AVDD	Analog Power Supply. Bypass to GND with a 1 $\mu$ F capacitor placed as close as possible.		Supply
C4, D5, E5	AGND	Analog Ground. Connect to the common ground plane of the application.		Supply
E3	VREFC	Internal Bias. Bypass to GND with a 1 $\mu$ F capacitor.	PVDD	
A3	$\overline{\text{RESET}}$	Hardware Enable (Active Low). Resets all digital portions of the device and all registers to default PoR settings.	DVDDIO	Digital Input
D1, D2	OUTP	Positive Speaker Amplifier Output	PVDD	Analog Output
D3	OUTPSNS	Voltage Sense and Speaker Amplifier Feedback Positive Input. Connect as close as possible to the positive terminal of the loudspeaker. This pin must form a complete loop with OUTP and is not intended to be driven externally.	PVDD	Analog Output
B1, B2	OUTN	Negative Speaker Amplifier Output	PVDD	Analog Output
B3	OUTNSNS	Voltage Sense and Speaker Amplifier Feedback Negative Input. Connect as close as possible to the negative terminal of the loudspeaker. This pin must form a complete loop with OUTN and is not intended to be driven externally.	PVDD	Analog Output
B7	I2C1	I <sup>2</sup> C-Compatible Serial-Data/Clock 1. This pin can be configured as either a SDA or SCL. Connect a 1.5k $\Omega$ pullup resistor to DVDDIO for full logic level swing.	DVDDIO	Digital I/O (Open drain)
A6	I2C2	I <sup>2</sup> C-Compatible Serial-Data/Clock 2. This pin can be configured as either a SDA or SCL. Connect a 1.5k $\Omega$ pullup resistor to DVDDIO for full logic level swing.	DVDDIO	Digital I/O (Open Drain)
B6	ADDR	I <sup>2</sup> C Address Select. Selects one of eight I <sup>2</sup> C slave addresses in conjunction with I2C1 and I2C2 pins.	DVDDIO	Digital Input
A5	IRQ	Hardware Interrupt Output. Interrupt polarity and pin drive mode are configurable. Connect a 1.5k $\Omega$ pullup resistor to DVDDIO for full logic level swing in open drain mode.	DVDDIO	Digital Output
E7	BCLK	PCM Interface BCLK Input. Internally pulled down to DGND through R <sub>PD</sub> .	DVDDIO	Digital Input
E6	LRCLK	PCM Interface Frame Clock Input/Output. LRCLK frequency matches the PCM interface sample rate. Internally pulled down to DGND through R <sub>PD</sub> .	DVDDIO	Digital Input
D7	DIN	PCM Interface Data Input. Internally pulled down to DGND through R <sub>PD</sub> .	DVDDIO	Digital Input
C7	DOUT	PCM Interface Data Output	DVDDIO	Digital Output
D6	LV_EN	Low Voltage Enable Output. This pin signals an external boost the active power supply used by the amplifier output stage. The pin is asserted when the amplifier uses VBAT as the supply for the output stage.	DVDDIO	Digital Output (Open Drain)
A7	ICC	Interchip Communication Data Bus. Optionally allows multiple devices to be grouped up to communicate with each other. Internally pulled down to DGND through R <sub>PD</sub> .	DVDDIO	Digital I/O

Functional Diagrams

Detailed Block Diagram

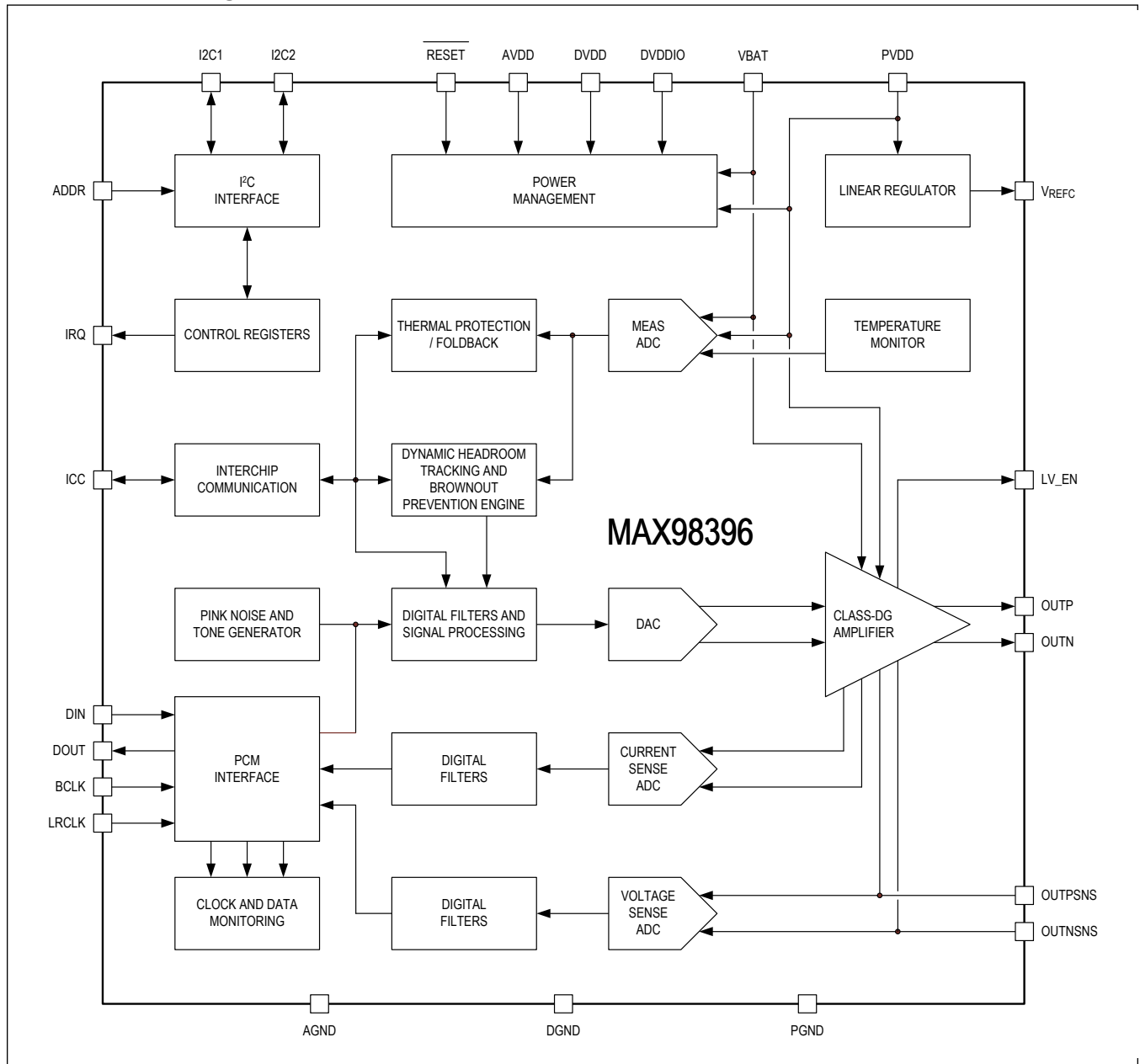

## Detailed Description

### Device State Control

The device has three distinct power states: the hardware shutdown state, software shutdown state, and active state. When transitioning between states, the device always moves from the hardware shutdown state to the software shutdown state to the active state (or the reverse) based on the state transition requirements. Normal transitions between the software shutdown state and active state are reversible without waiting for an in-progress transition to be completed. State transitions due to fault conditions, supply removal, and reset conditions are not reversible and are always completed (once initiated) to protect the device.

### Hardware Shutdown State

When the device is first powered up or after a hardware reset event, the device always initializes into the hardware shutdown state. In hardware shutdown, the device is configured to its lowest power state. Upon entering hardware shutdown, the device is globally placed into a reset condition. As a result, the I<sup>2</sup>C control interface is disabled and all device registers are returned to their PoR states. When exiting hardware shutdown, the device initializes and then transitions into the software shutdown state. During this transition (as part of initialization), the OTP register trim settings are loaded. If the OTP load routine fails to complete successfully, an [OTP\\_FAIL \\*](#) interrupt is generated once the device reaches the software shutdown state.

When the hardware reset input ( $\overline{\text{RESET}}$ ) is asserted low, the device enters (or remains in) hardware shutdown. The device is also placed into hardware shutdown anytime the AVDD, DVDD, or DVDDIO supplies drop below their respective UVLO thresholds. The device only exits hardware shutdown when the AVDD, DVDD, and DVDDIO supplies are all above their respective UVLO thresholds and the hardware reset input ( $\overline{\text{RESET}}$ ) is asserted high. Once all of these conditions are met, the device automatically exits hardware shutdown and transitions into software shutdown.

### Software Shutdown State

The device enters the software shutdown state after it transitions out of the hardware shutdown state and when exiting the active state. In the software shutdown state, all blocks are automatically disabled except for the I<sup>2</sup>C control interface. In the software shutdown state, all device registers can be programmed without restriction and all programmed register states are retained.

The global enable bit ([EN](#)) is used to transition the device into and out of software shutdown. When global enable ([EN](#)) is set high, the device transitions to the active state and a power-up done ([PWRUP\\_DONE \\*](#)) interrupt is generated. When the device is in the active state and global enable ([EN](#)) is set low, the device transitions to the software shutdown state and a power-down done ([PWRDN\\_DONE \\*](#)) interrupt is generated. Additionally, the device is reset and enters software shutdown anytime the global enable bit ([RST](#)) is written with a 1.

By default, the device supply configuration is PVDD and VBAT pins being supplied with voltages and in this scenario, regardless of the state of the global enable bit, the device cannot transition from the software shutdown state to the active state until PVDD and VBAT are all above their UVLO thresholds. If PVDD or VBAT supplies drop below their UVLO levels while the device is in the active state, the device is forced back into the software shutdown state.

In systems where the VBAT supply is not available, the device is configured to operate with PVDD only by connecting the VBAT pin to the VREFC pin on the PCB and setting the NOVBAT bit to 1. In this scenario, regardless of the state of the global enable bit, the device cannot transition from the software shutdown state to the active state until PVDD is above its UVLO thresholds. If PVDD supply drops below its UVLO levels while the device is in the active state, the device is forced back into the software shutdown state.

While in the software shutdown state, the PVDD and VBAT (if applicable) supplies can be powered down safely.

### Recovery from Software Shutdown due to Supply Faults

The device provides two forms of fault recovery in the event that either VBAT or PVDD drop below their UVLO thresholds while the device is in its active state. Based on the setting of the [VBAT\\_AUTORESTART\\_EN](#) and [PVDD\\_AUTORESTART\\_EN](#) bits, the individual supply fault recovery is either in manual mode or auto restart mode.

If the bit is set low, then the supply UVLO fault recovery is in manual mode. In manual mode, when the supply drops below its UVLO threshold, the device transitions into the software shutdown state (sets  $EN = 0$ ) and generates the appropriate UVLO fault shutdown interrupt ( $VBAT\_UVLO\_SHDN^*$  or  $PVDD\_UVLO\_SHDN^*$  respectively). Even once the supply recovers (when voltage levels exceed the UVLO thresholds), the device remains in the software shutdown state until the global enable bit ( $EN$ ) is set high by the host software.

If the bit is instead set high, then the supply UVLO fault recovery is in auto restart mode. In auto restart mode, when the supply drops below its UVLO threshold, the device is internally forced into software shutdown ( $EN$  state is preserved and remains high) and generates the appropriate UVLO fault shutdown interrupt ( $VBAT\_UVLO\_SHDN^*$  or  $PVDD\_UVLO\_SHDN^*$  respectively). Once the supply recovers (voltage levels exceed the UVLO thresholds), the device is no longer held in software shutdown and automatically restarts back into the active state (if all other conditions are met). These recovery modes do not apply when the AVDD, DVDD, or DVDDIO supplies cause a UVLO fault while the device is in the active state. If AVDD, DVDD, or DVDDIO drop below their UVLO thresholds, the device is reset and is placed into hardware shutdown.

### Active State

The device always enters the active state through a transition from the software shutdown state. In the active state, all enabled device blocks are active and speaker amplifier playback is possible. In the active state, only dynamic register settings (or those restricted to disabled blocks) can be programmed safely.

The only non-fault state transitions to or from the active state are those initiated through the global enable bit ( $EN$ ). All other transitions to or from the active state are the result of fault events, and can result in audible glitches if they occur during active playback.

### Device Sequencing

[Table 1](#) and [Table 2](#) show the recommended typical device power-up and power-down sequences.

**Table 1. Typical Power-Up Sequence**

STEP	ACTION	DETAILED DESCRIPTION
1	Power-Up Core Supplies	Power the PVDD, VBAT, DVDD, DVDDIO, and AVDD supplies above their UVLO thresholds. If the VBAT pin is unavailable in the system, connect the VBAT pin to the VREFC pin.
2	Exit Hardware Shutdown State	Assert the hardware reset input ( $\overline{RESET}$ ) to a logic high level. If $\overline{RESET}$ is tied to the DVDD/DVDDIO supply, this step is combined with step 1.
3	Enter Software Shutdown State	The device finishes the transition and enters the software shutdown state after the release from reset time ( $t_{12C\_READY}$ ) elapses.
4	Program the Device Registers/Enable the External Clocks	The I <sup>2</sup> C interface is active, and all registers can be freely configured. If the VBAT pin is unavailable in the system, set the NOVBAT bit to logic high. Start both external clocks before exiting the software shutdown state.
5	Exit Software Shutdown State	If volume ramping is disabled, the input audio data should be silent. Set the global enable to a logic high ( $EN = 1$ ).
6	Enter the Active State	Device enters the active state after the turn-on time ( $t_{ON}$ ) elapses.
7	Active State/Audio Playback	Dynamic bits (and those restricted to disabled blocks) can be programmed. The device is capable of audio playback in the active state.

**Table 2. Typical Power-Down Sequence**

STEP	ACTION	DETAILED DESCRIPTION
1	Exit the Active State	If volume ramping is disabled, the input audio data should be silent. Set the global enable bit to a logic low ( $EN = 0$ ).
2	Enter Software Shutdown State	Device enters software shutdown state after the turn-off time ( $t_{OFF}$ ) elapses.



**Table 2. Typical Power-Down Sequence (continued)**

STEP	ACTION	DETAILED DESCRIPTION
3	Reprogram Device Registers/Disable the External Clocks	The device is fully programmable, and can idle in the software shutdown state. To return to the active state, resume the power-up sequence from step 5.
4	Enter Hardware Shutdown State	For full hardware shutdown, disable the external clocks first. Assert the reset input ( $\overline{\text{RESET}}$ ) to ground or power down DVDD/DVDDIO. The AVDD/PVDD/VBAT supplies (if applicable) can be disabled.

### PCM Interface

The flexible PCM slave interface supports common audio playback sample rates from 16kHz to 192kHz and I/V sense ADC sample rates from 8kHz to 192kHz. The PCM interface also supports standard I<sup>2</sup>S, left-justified, and TDM data formats. The PCM interface is disabled and powered down when both the PCM data input (DIN) and PCM data output (DOUT) are disabled.

### PCM Clock Configuration

The PCM slave interface requires the host to supply both BCLK and LRCLK. To configure the PCM interface clock inputs, the host must program both the device interface sample rate (*PCM\_SR*) and BCLK to LRCLK (*PCM\_BSEL*) ratio. The PCM interface sample rate must be configured to match the frequency of the frame clock (LRCLK) using the *PCM\_SR* registers. The speaker path sample rate is also set by the *PCM\_SR* setting. However, the I/V sense ADC path sample rate (*IVADC\_SR*) can be set to the same rate or lower rate than the speaker path sample rate (*PCM\_SR*) according to the restrictions in Table 3. When the I/V sense ADC path is set to a lower rate than the speaker amplifier path, the output data contains repeated samples.

**Table 3. Sample Rate Selection for I/V Sense**

N/A = Not Available N/S = Not Supported	I/V SENSE ADC SAMPLE RATE (kHz)												
	192	96	88.2	48	44.1	32	24	22.05	16	12	11.025	8	
PCM Interface and Speaker Path Sample Rate (kHz)	192	1	2	N/S	4	N/S	6	8	N/S	12	16	N/S	24
	96	N/A	1	N/S	2	N/S	3	4	N/S	6	8	N/S	12
	88.2	N/A	N/A	1	N/S	2	N/S	N/S	4	N/S	N/S	8	N/S
	48	N/A	N/A	N/A	1	N/S	N/S	2	N/S	3	4	N/S	6
	44.1	N/A	N/A	N/A	N/A	1	N/S	N/S	2	N/S	N/S	4	N/S
	32	N/A	N/A	N/A	N/A	N/A	1	N/S	N/S	2	N/S	N/S	4
	24	N/A	N/A	N/A	N/A	N/A	N/A	1	N/S	N/S	2	N/S	3
	22.05	N/A	N/A	N/A	N/A	N/A	N/A	N/A	1	N/S	N/S	2	N/S
	16	N/A	N/A	N/A	N/A	N/A	N/A	N/A	N/A	1	N/S	N/S	2

The device supports a range of BCLK to LRCLK clock ratios (*PCM\_BSEL*) ranging from 32 to 512. However, based on the selected PCM interface sample rate (LRCLK frequency), the configured clock ratio cannot result in a BCLK frequency that exceeds 24.576MHz.

### PCM Data Format Configuration

The device supports the standard I<sup>2</sup>S, left-justified, and TDM data formats. The operating mode is configured using the *PCM\_FORMAT* bit field.

### I<sup>2</sup>S/Left-Justified Mode

I<sup>2</sup>S and left-justified formats support two channels that can be 16-, 24-, or 32-bits in length. The BCLK to LRCLK ratio (*PCM\_BSEL*) must be configured to be twice the desired channel length. The audio data word size is configurable to 16-, 24-, or 32-bits in length (*PCM\_CHANSZ*), but must be programmed to be less than or equal to the channel length. If

the resulting channel length exceeds the configured data word size then the data input LSBs are truncated and the data output LSBs are padded with either zero or Hi-Z data based on the [PCM\\_TX\\_EXTRA\\_HIZ](#) register bit setting.

**Table 4. Supported I<sup>2</sup>S/Left-Justified Mode Configurations**

CHANNELS	CHANNEL LENGTH	BCLK TO LRCLK RATIO ( <a href="#">PCM_BSEL</a> )	SUPPORTED DATA WORD SIZES ( <a href="#">PCM_CHANSZ</a> )
2	16	32	16
	24	48	16, 24
	32	64	16, 24, 32

With the default PCM settings, falling LRCLK indicates the left channel data (Channel 0) and the start of a new frame while rising LRCLK indicates the right channel data (Channel 1). In I<sup>2</sup>S mode, the MSB of the audio word is latched on the second active BCLK edge after an LRCLK transition. In left-justified mode, the MSB of the audio word is latched on the first active BCLK edge after an LRCLK transition.

The [PCM\\_BCLKEDGE](#) register bit selects either the rising or falling edge of BCLK as the active edge that is used for data capture (DIN) and data output (DOUT). The [PCM\\_CHANSEL](#) bit configures which LRCLK edge indicates the start of a new frame (Channel 0), and LRCLK transitions always align with the inactive BCLK edge. The data output is valid on the same active BCLK edge as the data input. The data output also transitions on the same edge as the data input.

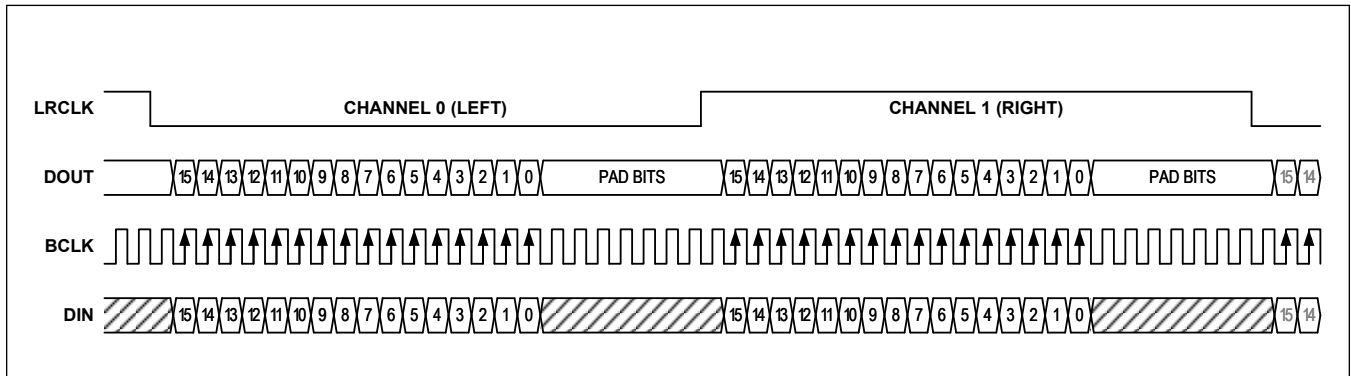

Figure 1. Standard I<sup>2</sup>S Mode

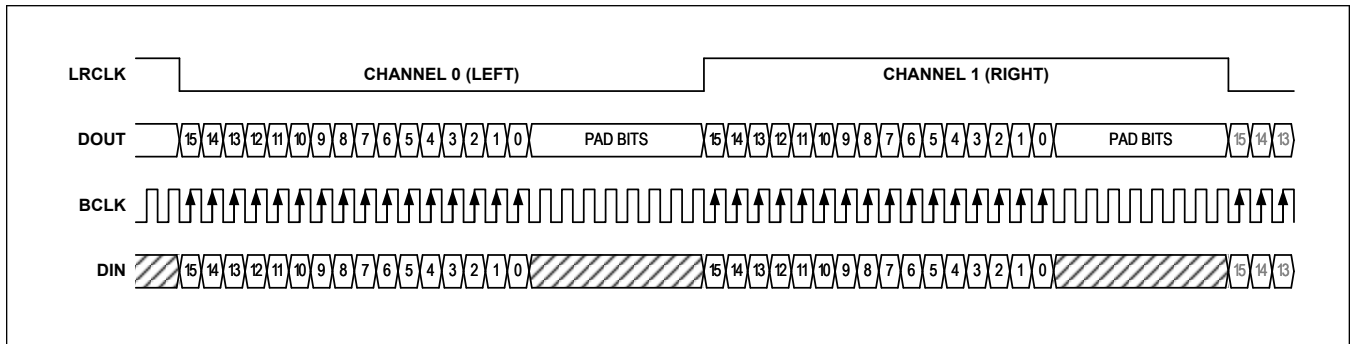

Figure 2. Left-Justified Mode

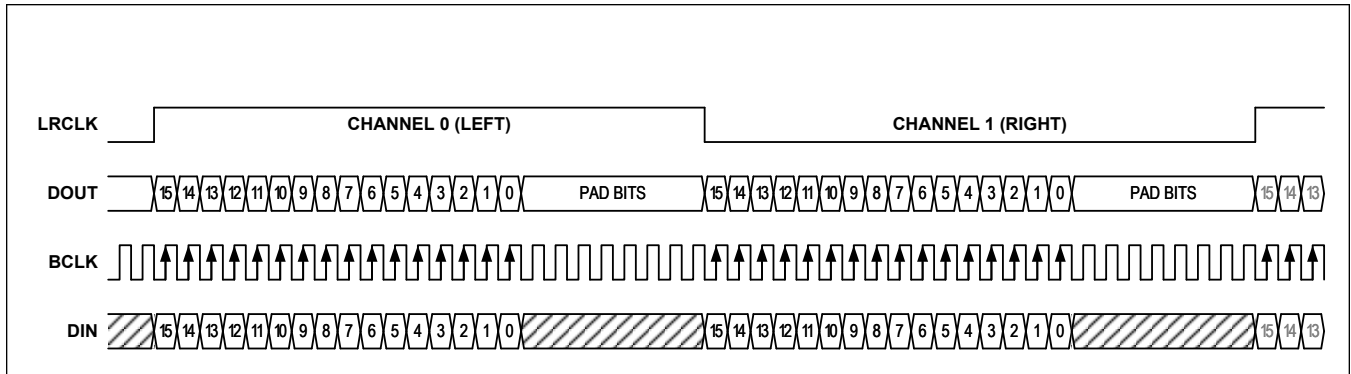

Figure 3. Left-Justified Mode (LRCLK Inverted)

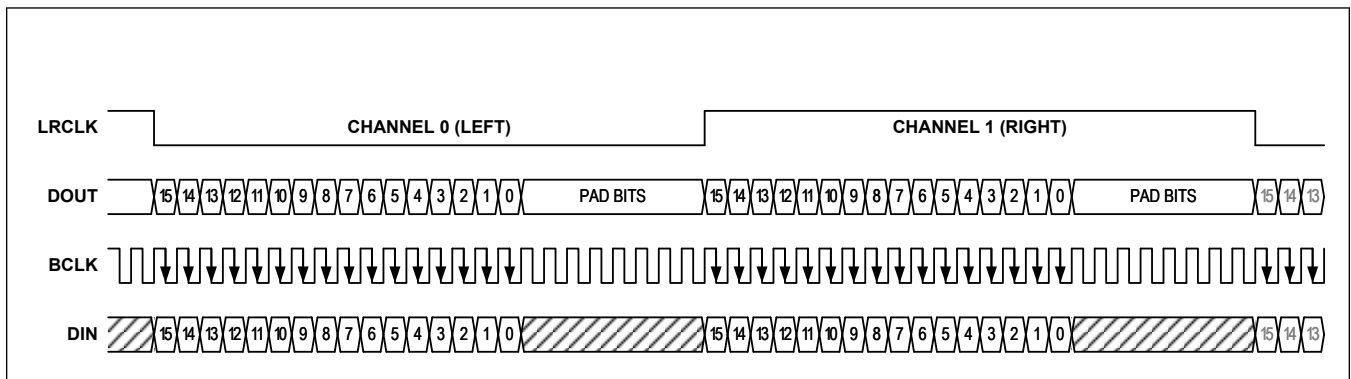

Figure 4. Left-Justified Mode (BCLK Inverted)

**TDM Modes**

The provided TDM modes support timing for up to 16 digital audio input channels (DIN), each containing 16-, 24-, or 32-bits of data. The digital audio output (DOUT) is structured into 8-bit slots, and the timing can support up to a maximum of 128 data output slots. The number of TDM input channels and output slots is determined by both the selected BCLK to LRCLK ratio ([PCM\\_BSEL](#)) and the selected data word and channel length ([PCM\\_CHANSZ](#)).

For a given valid configuration, the number of available data input channels per frame is calculated as follows:

$$\text{Number of Available Data Input Channels} = \text{BCLK to LRCLK Ratio} / \text{Channel Length}$$

For a given valid configuration, the number of available 8-bit data output slots per frame is calculated as follows:

$$\text{Number of Available Data Output Slots} = \text{BCLK to LRCLK Ratio} / 8$$

[Table 5](#) shows the supported TDM mode configurations for each combination of input data channels and output data slots. In some configurations, the maximum PCM interface and speaker amplifier playback sample rate is limited to less than 96kHz to avoid violating the BCLK frequency limit of 24.576MHz.

**Table 5. Supported TDM Mode Configurations**

INPUT DATA CHANNELS	OUTPUT DATA SLOTS	DATA WORD SIZES (PCM_DATA_WIDTH)	BCLK TO LRCLK RATIO (PCM_BSEL)	MAXIMUM SPEAKER PLAYBACK SAMPLE RATE (FLRCLK)
2	4	16	32	192kHz
	6	24	48	
	8	32	64	
3	15	32	125	

**Table 5. Supported TDM Mode Configurations (continued)**

INPUT DATA CHANNELS	OUTPUT DATA SLOTS	DATA WORD SIZES (PCM_DATA_WIDTH)	BCLK TO LRCLK RATIO (PCM_BSEL)	MAXIMUM SPEAKER PLAYBACK SAMPLE RATE (FLRCLK)
4	8	16	64	96kHz
	12	24	96	
	16	32	128	
5	15	24	125	
7	15	16	125	
2	4	16	32	
	6	24	48	
	8	32	64	
3	15	32	125	
4	8	16	64	
	12	24	96	
	16	32	128	
5	15	24	125	
7	15	16	125	
	31	32	250	
8	16	16	128	
	24	24	192	
	32	32	256	
10	31	24	250	
15	31	16	250	
16	32	16	256	
7	31	32	250	48kHz
10	31	24	250	
10	40	32	320	
15	31	16	250	
16	48	24	384	
	64	32	512	

With the default PCM interface settings in TDM mode, a rising frame clock (LRCLK) edge acts as the frame sync pulse and indicates the start of a new frame. The frame sync pulse width must be equal to at least one bit clock period. However, the falling edge can occur at any time as long as it does not violate the setup time of the next frame sync pulse rising edge. The [PCM\\_CHANSEL](#) bit can be used to invert the LRCLK edges (sync pulse) used to start a TDM frame.

In TDM mode, the MSB of the first audio word can be latched on the first (TDM Mode 0), second (TDM Mode 1), or third (TDM Mode 2) active BCLK edge after the sync pulse and is programmed by the [PCM\\_FORMAT](#) bits. Additionally, the [PCM\\_BCLKEDGE](#) register bit allows the BCLK edge (that is used for data capture and data output) to be programmed. The data output is valid on the same active BCLK edge as the data input. The data output also transitions on the same edge as the data input.

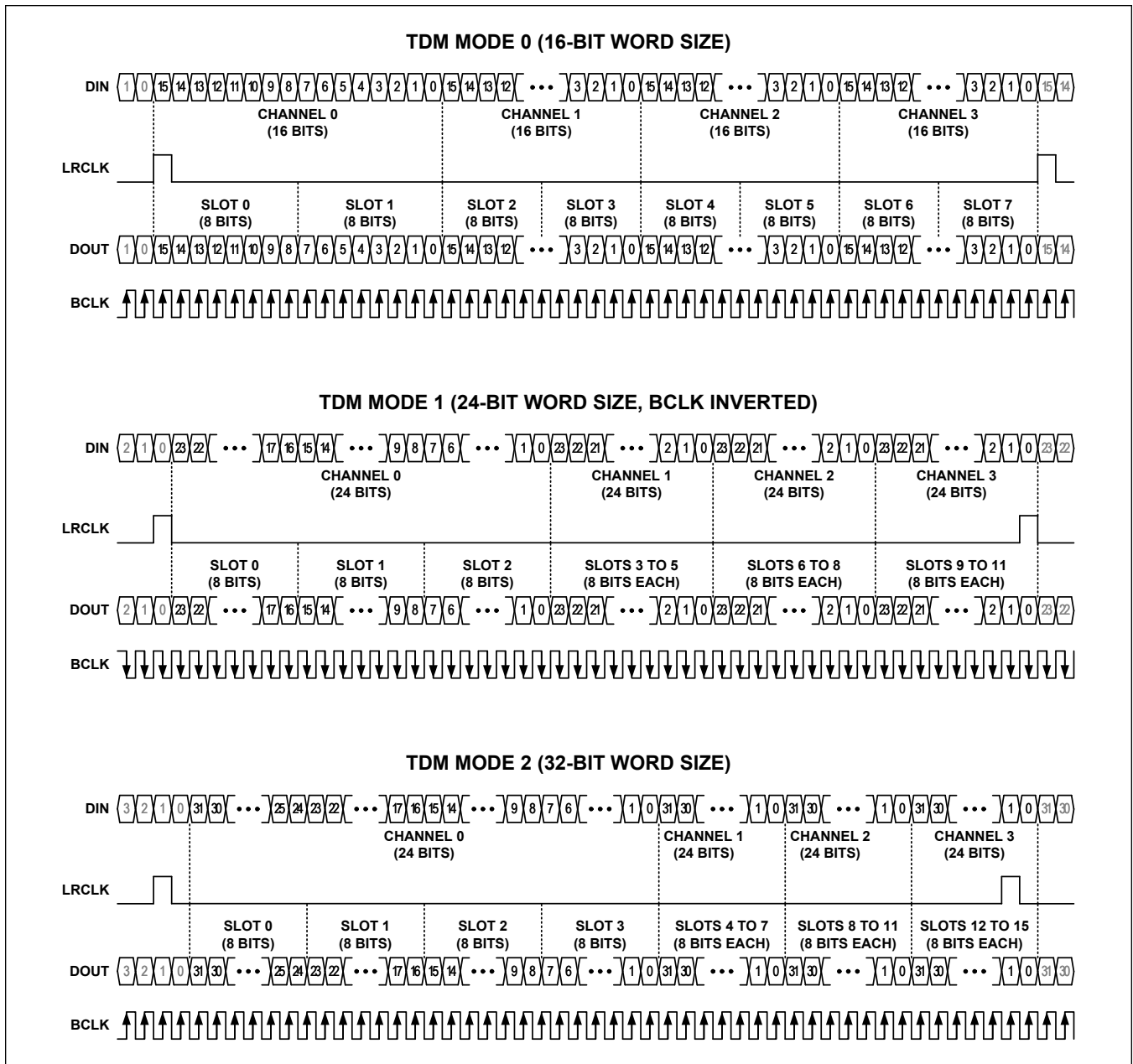

Figure 5. TDM Modes

**PCM Data Path Configuration**

The PCM interface data input (DIN) receives the source data for the speaker amplifier path and the speaker audio processing bypass path while the data output (DOUT) transmits the data from the I/V sense ADC path. In addition, the PCM data output can also transmit internal diagnostic data such as the speaker DSP monitor path, supply measurement ADC results, device status reporting, and the DHT attenuation level.

## PCM Data Input

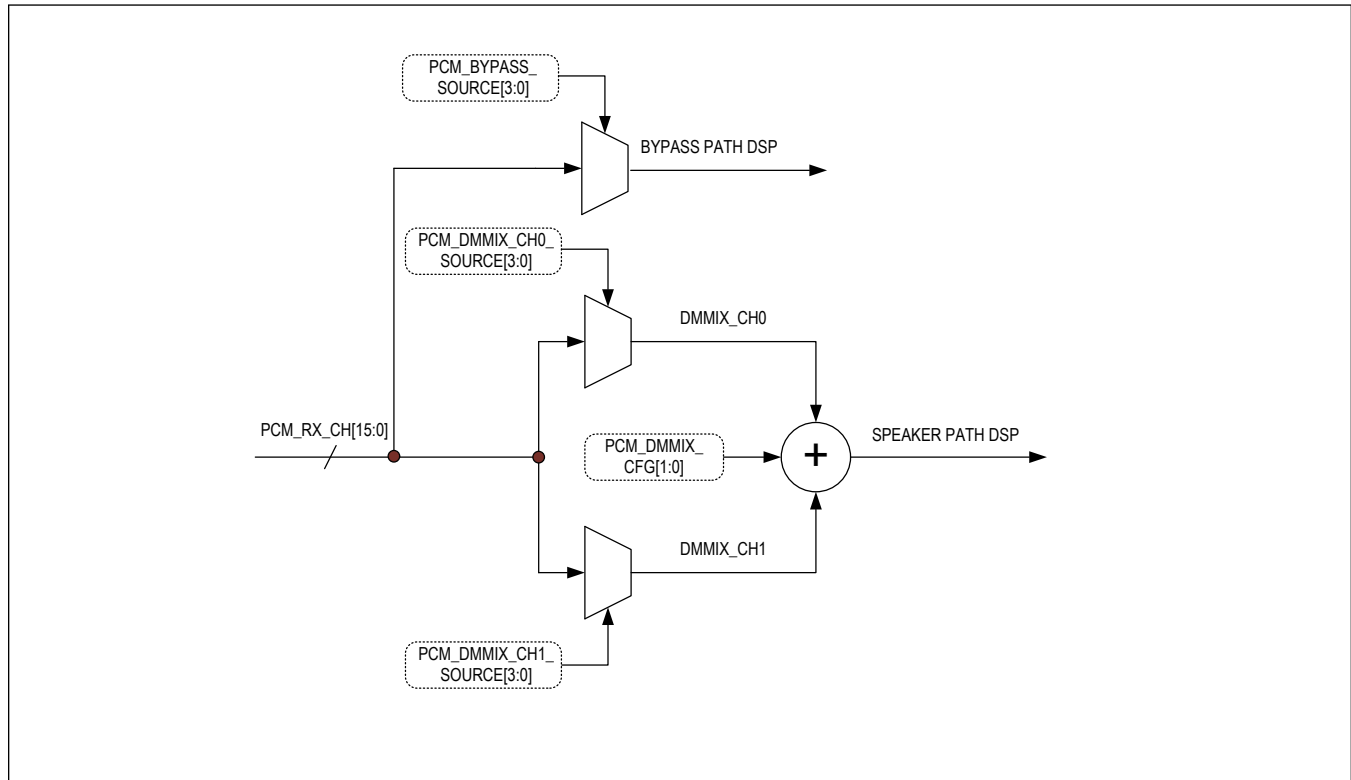

Figure 6. PCM Data Input

The PCM playback path is enabled with the `PCM_RX_EN` bit and can accept data from any valid input data channel. The device provides an input digital mono mixer that can route a single channel or mix two PCM input channels to create a mono input to the speaker playback path. The `PCM_DMMIX_CFG` bit is used to configure the mixer, while the `PCM_DMMIX_CH0_SOURCE` and `PCM_DMMIX_CH1_SOURCE` bits select which of the 16 PCM input channels are used as the input to the mono mixer. In I<sup>2</sup>S and left-justified modes, only two input data channels are available while in TDM mode up to 16 channels of input data can be available. If the PCM playback path is disabled (`PCM_RX_EN = 0`), a zero code value is driven into the speaker amplifier path.

The device also supports an audio processing bypass path from the PCM input to speaker amplifier output that bypasses the audio processing blocks like the volume control, DHT, BPE, and thermal foldback circuits. The audio processing bypass path is enabled by setting the `PCM_BYP_EN` bit field to 1. The PCM data input for the audio processing bypass path is selected with the `PCM_BYPASS_SOURCE` bit field. If the PCM audio processing bypass path is disabled (`PCM_BYP_EN = 0`), a zero code value is driven into the audio processing bypass path.

## PCM Data Output

The PCM interface data output (DOUT) is enabled by the `PCM_TX_EN` bit field, and can transmit any output data type onto any valid output channel or slot. In I<sup>2</sup>S and left-justified mode, only two data output channels are available in each output transmit frame (Channel 0 and 1). In TDM mode, each output transmit frame can contain up to 64 sequential 8-bit data output slots, each of which are numbered from 0 up to a maximum of 63.

The PCM data output can transmit several different output data types. In I<sup>2</sup>S and left-justified modes, only the speaker amplifier output voltage sense, output current sense, and DSP monitor output data types are available for data output transmission. If the word size of the data output type is longer than output channel data word (`PCM_CHANSZ`), the lowest trailing bits are truncated.

In TDM mode, all output data types are available and are individually assigned to data output slots. The output data types vary in word size from 3 bits to 32 bits, and as a result require from 1 to 4 data output slots to transmit in TDM mode. [Table 6](#) shows the supported output data types and the parameters of each data type.

**Table 6. Supported PCM Data Output Types**

OUTPUT DATA TYPE	SYMBOL	DATA WORD SIZE (BITS)	NUMBER OF TDM SLOTS	ENABLE/SLOT ASSIGNMENT
Speaker Amplifier Output Voltage Sense	VMON	16	2	<a href="#">PCM_VMON_EN/</a> <a href="#">PCM_VMON_SLOT</a>
Speaker Amplifier Output Current Sense	IMON	16	2	<a href="#">PCM_IMON_EN/</a> <a href="#">PCM_IMON_SLOT</a>
Speaker Amplifier DSP Monitor	DSPMON	32	4	<a href="#">PCM_DSPMONITOR_EN/</a> <a href="#">PCM_DSP_MONITOR_SLOT</a>
Applied DHT Attenuation	DHT_ATN	16	2	<a href="#">PCM_DHT_ATN_EN/</a> <a href="#">PCM_DHT_ATN_SLOT</a>
Battery Voltage (V <sub>VBAT</sub> )	VBAT	16	2	<a href="#">PCM_VBAT_EN/</a> <a href="#">PCM_VBAT_SLOT</a>
PVDD Voltage (V <sub>PVDD</sub> )	PVDD	16	2	<a href="#">PCM_PVDD_EN/</a> <a href="#">PCM_PVDD_SLOT</a>
BPE Level	BPELVL	3	1	<a href="#">PCM_BPE_EN/</a> <a href="#">PCM_BPE_SLOT</a>
Device Status Flags	FLAG	14	2	<a href="#">PCM_STATUS_EN/</a> <a href="#">PCM_STATUS_SLOT</a>

An individual enable and slot assignment bit field is provided for each output data type. In I<sup>2</sup>S and left-justified modes, use output slot 0 to assign data to Channel 0 and output slot 1 to assign data to Channel 1. In TDM mode, the slot assignment selects the slot where the output data type transmit begins for data output types requiring more than one slot to transmit (e.g., a two slot data type assigned to slot 6 would occupy slots 6 and 7).

In TDM mode, each data type can be assigned to any valid data output slot (or series of slots) with some restrictions. First, it is invalid for data types to be assigned such that the data word extends beyond the end of the data output frame. For example, data types that require two slots to transmit cannot be assigned to the last slot of the frame. Next, it is also invalid to assign a data output type to any slot that overlaps with the slot assignment of another data type (this also applies to channels in I<sup>2</sup>S and left-justified modes). Finally, it is invalid to assign a data type to any slots that do not exist in the frame structure of the current PCM interface configuration.

Any data output (DOUT) slots that exist in the current frame structure but have no output data type assigned to them are either Hi-Z or driven with a 0 code (as set by the [PCM\\_TX\\_SLOT\\_HIZ](#) bit field). Likewise, if a data output type is disabled, then the assigned data output slot(s) are also either Hi-Z or driven with a 0 code (as set by the [PCM\\_TX\\_SLOT\\_HIZ](#) bit field).

#### Data Output Channel-Interleaved I/V Sense Data

In I<sup>2</sup>S and left-justified use cases, the PCM interface limits the number of available data output channels to two making it impossible to fit amplifier output current and voltage sense data from stereo devices on a single shared data output (DOUT) line. For these cases, the data output can be configured to allow the current and voltage sense data types from a single device to share a single data output channel. To enable channel-interleaved mode, set the [PCM\\_TX\\_INTERLEAVE](#) bit high. Then assign the current and voltage sense data types to the same valid data channel (using [PCM\\_VMON\\_SLOT](#) and [PCM\\_IMON\\_SLOT](#)).

In this configuration, the current and voltage sense data types are frame interleaved on the assigned data output channel. The current and voltage sense data words are both 16-bits in length, and as a result if the channel length is longer than 16-bits the trailing padding bits are set to either Hi-Z or zero code depending on the state of the [PCM\\_TX\\_EXTRA\\_HIZ](#) bit field.

To identify the data type in channel-interleaved mode, the LSB of the 16-bit data word is dropped (truncated). The data word is then right shifted by a single bit, and the now vacant MSB is replaced with either a 0 to indicate voltage sense data or a 1 to indicate current sense data. For phase alignment, the voltage sense data for a single sampling instant is always transmitted in the assigned channel on the first frame, followed by the current sense data on the second frame. The MSB value and the transmission order allow the host to identify and phase-align the output data across frames.

Since the I/V sense data is frame interleaved, the sample rate for the PCM interface must be greater than that of the I/V sense ADCs by an integer ratio of 2. The example below shows a basic case where the sample rate of the PCM interface is twice that of the I/V sense ADCs.

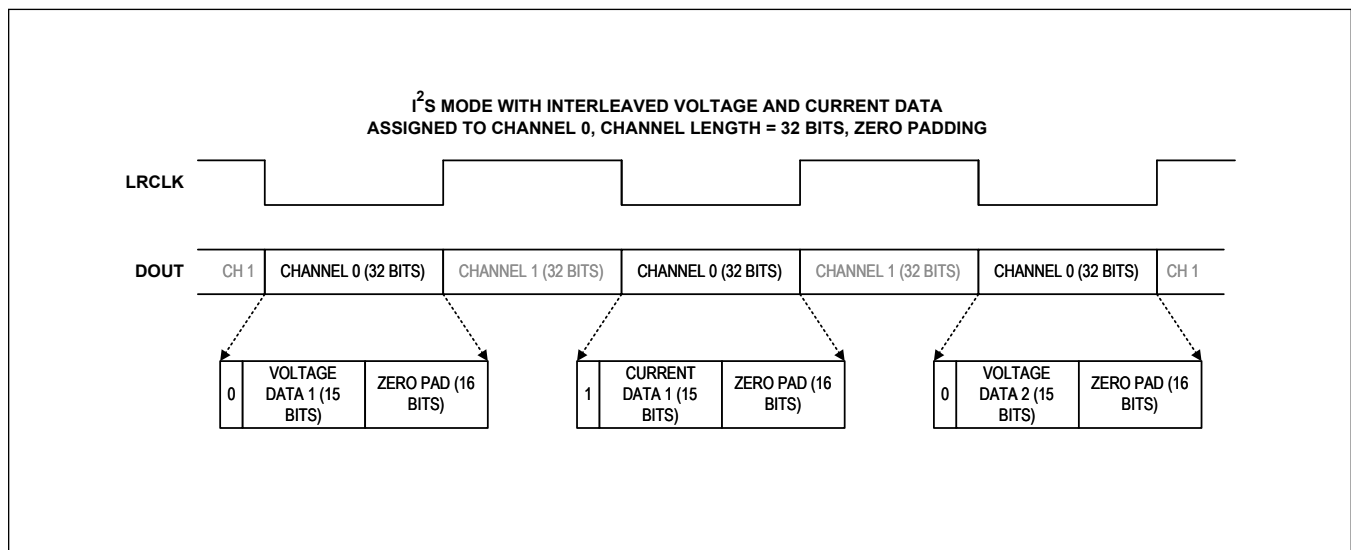

Figure 7. I/V Sense Path Data Interleaved on a Single Data Output Channel

### Data Output Status Bits

The following interrupt information is reported in the status slots:

- Bit 15: BPE level 0 begin
- Bit 14: BPE level change
- Bit 13: BPE active begin
- Bit 12: BPE active end
- Bit 11: Thermal warning 1 begin
- Bit 10: Thermal warning 1 end
- Bit 9: Thermal warning 2 begin
- Bit 8: Thermal warning 2 end
- Bit 7: Thermal foldback begin
- Bit 6: Thermal foldback end
- Bit 5: DHT active end
- Bit 4: DHT active begin
- Bit 3: Speaker overcurrent
- Bit 2: Power-up done
- Bit 1: 0
- Bit 0: 0

Each of the interrupt information above corresponds to a raw interrupt and is 1 bit wide. When a raw interrupt has a rising edge, the corresponding status bit goes high during the next LRCLK frame. The status bit goes low during the next LRCLK frame even if the raw interrupt has remained high.



**PCM Interface Timing**

Figure 8 and Figure 9 shows timing for BCLK, LRCLK, DIN, and DOUT. See the Electrical Characteristics table for more details.

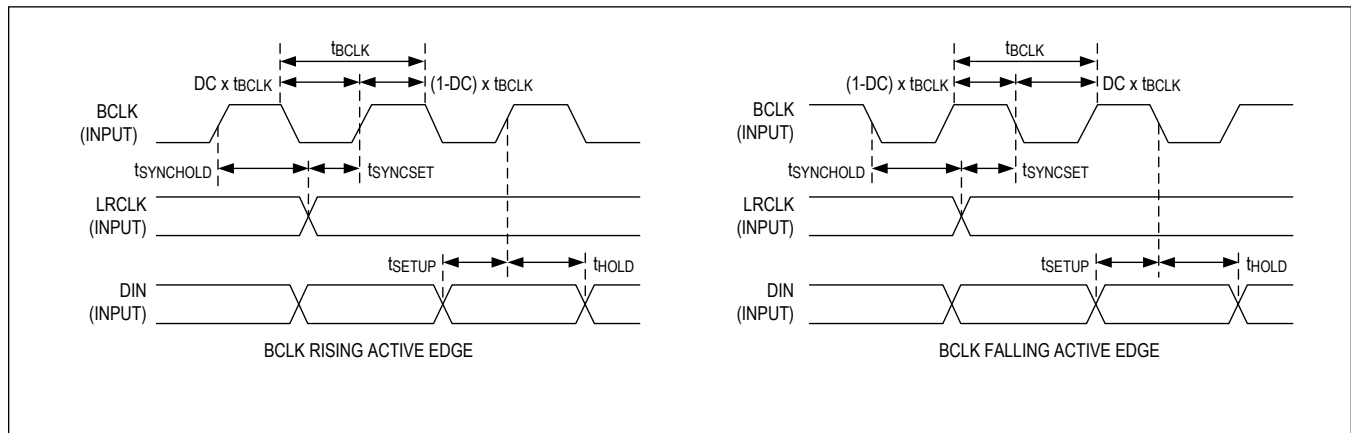

Figure 8. PCM Interface Timing/Slave Mode—LRCLK, BCLK, DIN Timing Diagram

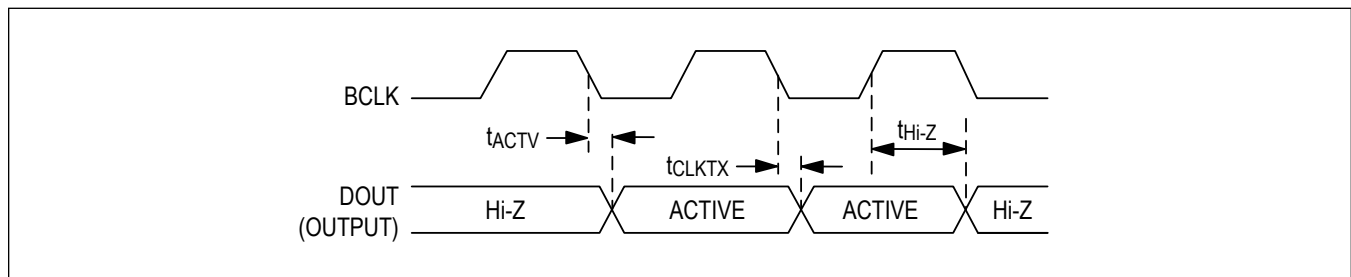

Figure 9. PCM Interface Timing/DOUT Timing Diagram

**Interrupts**

The device supports individually enabled status interrupts for sending feedback to the host about events that have occurred on-chip. When enabled, interrupts are transmitted on the IRQ output.

**Interrupt Bit Field Composition**

Each interrupt source has five individual bit field components. The function of each component is detailed as follows, and the corresponding bit fields for each source can be identified by the appended suffix (shown in parentheses).

- **Raw Status (RAW):** Each interrupt source has a read-only bit to indicate the real-time raw status of the interrupt source.
- **State (STATE):** Each interrupt source has a read-only state bit that is set whenever a rising edge occurs on the associated raw status bit. The state bit is set regardless of the setting of the source enable bit.
- **Flag (FLAG):** Each interrupt source has a read-only flag bit. If the source enable bit is set, then the flag bit is set and an interrupt can be generated whenever the source state bit is set.
- **Enable (EN):** Each interrupt source has a dynamic read/write enable bit. When the enable bit is set, the associated flag bit is set and an interrupt can be generated whenever the source state bit is set.
- **Clear (CLR):** Each interrupt source has a dynamic write-only clear bit. Writing a 1 to a clear bit resets the associated state and flag bits to 0. Writing a 0 to a clear bit has no effect. In I<sup>2</sup>C control mode, the IRQ output is deasserted if all flag bits are 0.

### Interrupt Output Configuration

The device allows the user to configure the drive mode, drive strength, and polarity of the IRQ output. The [IRQ\\_MODE](#) bit controls the drive mode. If [IRQ\\_MODE](#) is 0, the pin is configured as an open-drained output and requires an external pullup resistor. If [IRQ\\_MODE](#) is 1, then IRQ is configured as a push-pull CMOS output.

Additionally, when IRQ is configured as a push-pull CMOS output, the drive strength control ([IRQ\\_DRV](#)) bits set the drive strength of the IRQ output. Four different CMOS drive strengths are available.

The [IRQ\\_POL](#) bit controls the polarity of the IRQ bus. Interrupt events (a flag bit is set high) assert the IRQ bus low if [IRQ\\_POL](#) = 0 and high if [IRQ\\_POL](#) = 1. The IRQ bus deasserts if all flag bits are cleared (set low).

### Interrupt Sources

**Table 7. Interrupt Sources**

INTERRUPT SOURCES	BIT FIELD	DESCRIPTION
Thermal Shutdown Begin Event	<a href="#">THERMSHDN_BGN</a> *	Indicates when the thermal-shutdown threshold temperature has been exceeded.
Thermal Shutdown End Event	<a href="#">THERMSHDN_END</a> *	Indicates that the die temperature was previously above the thermal-shutdown threshold and has now dropped below the threshold.
Thermal Warning 1 Begin Event	<a href="#">THERMWARN1_BGN</a> *	Indicates when the thermal-warning1 threshold temperature has been exceeded.
Thermal Warning 1 End Event	<a href="#">THERMWARN1_END</a> *	Indicates that the die temperature was previously above the thermal-warning1 threshold and has now dropped below the threshold.
Thermal Warning 2 Begin Event	<a href="#">THERMWARN2_BGN</a> *	Indicates when the thermal-warning2 threshold temperature has been exceeded.
Thermal Warning 2 End Event	<a href="#">THERMWARN2_END</a> *	Indicates that the die temperature was previously above the thermal-warning2 threshold and has now dropped below the threshold.
Thermal Foldback Begin Event	<a href="#">THERMFEB_BGN</a> *	Indicates that the die temperature is above the thermal-warning1 threshold and the device is attenuating the output.
Thermal Foldback End Event	<a href="#">THERMFEB_END</a> *	Indicates die temperature is below thermal-warning1 threshold and device has stopped attenuating the output.
BPE Level Change Event	<a href="#">BPE_LEVEL</a> *	Indicates that the BPE has transitioned between thresholds.
BPE Active Begin Event	<a href="#">BPE_ACTIVE_BGN</a> *	Indicates that the BPE is active.
BPE Active End Event	<a href="#">BPE_ACTIVE_END</a> *	Indicates that the BPE is no longer active.
BPE Level 0 Begin Event	<a href="#">BPE_L0</a> *	Indicates that the BPE has transitioned into L0.
OTP Load Fail Event	<a href="#">OTP_FAIL</a> *	Indicates when the OTP load routine that runs when exiting hardware shutdown has failed to complete successfully. If the OTP load routine fails, the device is held in software shutdown.

**Table 7. Interrupt Sources (continued)**

Speaker Over Current Event	<u><a href="#">SPK_OVC *</a></u>	Indicates that the speaker amplifier current limit has been exceeded.
Internal CLK Error	<u><a href="#">INT_CLK_ERR *</a></u>	Indicates a clock stop error in the internal clocks of the device.
External CLK (BCLK/LRCLK) Error	<u><a href="#">CLK_ERR *</a></u>	Indicates a frequency or framing error in the input BCLK or LRCLK.
External CLK (BCLK/LRCLK) Recover	<u><a href="#">CLK_RECOVER *</a></u>	Indicates that the input BCLK or LRCLK has recovered after an error event.
Speaker Amplifier Monitor Error	<u><a href="#">INT_SPKMON_ERR *</a></u>	Indicates an amplifier output stuck high or low error.
External Data (DIN) Error	<u><a href="#">DMON_ERR *</a></u>	Indicates a data stuck or data magnitude error at the PCM data input (DIN).
Power-Up Done Event	<u><a href="#">PWRUP_DONE *</a></u>	Indicates when the device has entered the active state and the device is ready to play audio.
Power-Down Done Event	<u><a href="#">PWRDN_DONE *</a></u>	Indicates when the device has entered the software shutdown state.
PVDD UVLO Shutdown Event	<u><a href="#">PVDD_UVLO_SHDN *</a></u>	Indicates that PVDD is below the minimum allowed voltage when the device is in active state.
VBAT UVLO Shutdown Event	<u><a href="#">VBAT_UVLO_SHDN *</a></u>	Indicates that VBAT is below the minimum allowed voltage when the device is in active state.
DHT Active Begin Event	<u><a href="#">DHT_ACTIVE_BGN *</a></u>	Indicates that the DHT circuit is active and is applying attenuation to the signal.
DHT Active End Event	<u><a href="#">DHT_ACTIVE_END *</a></u>	Indicates that the DHT circuit has stopped applying attenuation to the signal.
<b>NOTE:</b> The bit fields are shown without the component suffixes. For example, OTP_FAIL_* refers to OTP_FAIL_RAW, OTP_FAIL_STATE, OTP_FAIL_FLAG, OTP_FAIL_EN, and OTP_FAIL_CLR. All interrupt sources have these five component bit fields.		

## Speaker Path

### Speaker Path Block Diagram

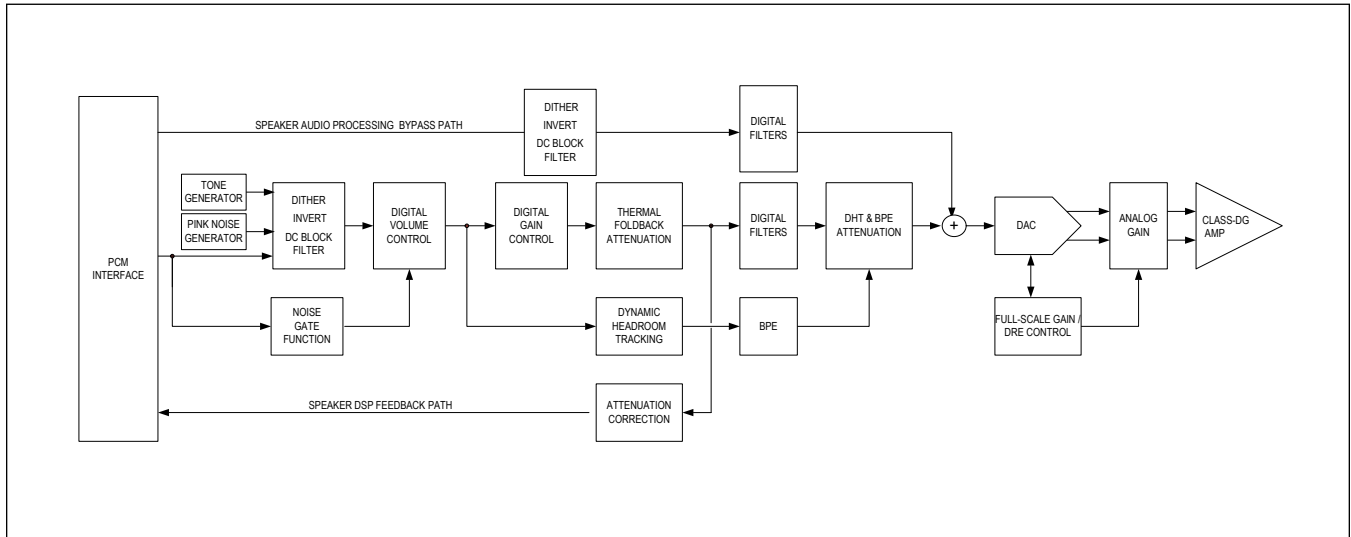

Figure 10. Speaker Signal Path Diagram

### Speaker Playback Path

The source input data to the speaker amplifier path is routed from either the PCM interface or the tone generator. The data is then routed through digital filters, signal processing, and volume/gain control blocks before reaching the Class-DG speaker amplifier.

### Speaker Path Noise Gate

The speaker path noise gate function is enabled when the device is in the active state and the noise gate enable ([NOISEGATE\\_EN](#)) is set to 1. The noise gate enable can be programmed dynamically. However, if the noise gate function is disabled ([NOISEGATE\\_EN](#) is set to 0) while the noise gate is active (speaker path actively muted), the noise gate function remains active until after it deactivates normally (unmutes the speaker path).

When the noise gate is enabled, the noise gate activates whenever the amplitude of the input audio data to the speaker path (from the PCM interface) is below the configured mute threshold ([MUTE\\_THRESH](#)) for more than 1024 consecutive data samples. When the noise gate is active, the amplifier path is muted, the current and voltage sense ADC paths output zero code data, and the device idles in a reduced power state.

The noise gate deactivates immediately if the amplitude of a single sample from the input audio data exceeds the configured unmute threshold ([UNMUTE\\_THRESH](#)). When the noise gate deactivates, the speaker path is unmuted and returns to normal operation before the input audio data (that triggered deactivation) reaches the speaker output. Once noise gate deactivation is complete, the current and voltage sense ADC paths resume operation and output data normally.

The noise gate mute and unmute threshold settings are selected in terms of the number of bits (starting from the LSB) that must be toggling (or active) in order for the input signal amplitude to exceed the thresholds. It is invalid to set the noise gate unmute threshold ([UNMUTE\\_THRESH](#)) such that it is less than the configured mute threshold ([MUTE\\_THRESH](#)). The location of the audio data LSB within the PCM input data channel is determined by the configured PCM data word size ([PCM\\_CHANSZ](#)). The supported combinations are shown in [Table 8](#).

**Table 8. Noise Gate/Idle Mode Threshold LSB Location by Input Data Configuration**

INPUT DATA WORD SIZE ( <a href="#">PCM_CHANSZ</a> )	NOISE GATE FUNCTION LSB LOCATION
16	16
24	24
32	

It is not valid to enable the speaker path noise gate function when the tone generator is enabled or when the speaker idle mode is enabled.

#### Speaker Path Dither

The input data to the speaker path can optionally have dither ( $\pm 1$ LSB peak-to-peak) applied if [SPK\\_DITH\\_EN](#) is set to 1. No dither is applied when [SPK\\_DITH\\_EN](#) is set to 0.

#### Speaker Path Data Inversion

The input data to the speaker path can optionally be inverted by setting the [SPK\\_INVERT](#) bit to 1. The input data to the speaker path can only be inverted when the speaker DC blocking filter is also enabled by setting [SPK\\_DCBLK\\_EN](#) to 1.

#### Speaker Path DC Blocking Filter

A DC blocking filter can be enabled on the speaker path by setting the [SPK\\_DCBLK\\_EN](#) bit to 1.

#### Speaker Path Digital Volume Control

The device has a dynamically programmable speaker path digital volume control. The digital volume control provides an attenuation range of 0dB to -63dB in 0.5dB steps that is configured with the [SPK\\_VOL](#) bit field. A digital mute is also provided, and is enabled when [SPK\\_VOL](#) is set to 0x7F.

Digital volume ramping during speaker path start up, speaker path shutdown, and digital mute ([SPK\\_VOL](#) = 0x7F) is disabled by default. However, both the volume ramp up and ramp down can be individually enabled with the [SPK\\_VOL\\_RMPUP\\_BYPASS](#) and [SPK\\_VOL\\_RMPDN\\_BYPASS](#) bit fields respectively. When volume ramp up or ramp down is enabled, the device turn-on and turn-off times are longer.

#### Speaker Path Digital Gain Control

The device provides a programmable speaker path digital gain control. The digital gain control provides a range of 0dB to +6dB in 0.5dB steps that is configured with the [SPK\\_GAIN](#) bit field. Unlike the digital volume control, the digital gain setting cannot be dynamically changed.

#### Speaker Path DSP Data Feedback Path

The speaker path DSP data can be routed from just before the DAC input back to the PCM interface, and can be assigned to any valid data output channel. The speaker path DSP data feedback path is enabled with the [SPK\\_FB\\_EN](#) bit.

#### Speaker Safe Mode

The device provides a safe mode bit ([SPK\\_SAFE\\_EN](#)) which applies a -18dB attenuation to the input signal when set to 1. By default, speaker safe mode is enabled to protect any speaker connected to the device on power-up. While speaker safe mode is enabled, the digital volume control ([SPK\\_VOL](#)) and speaker digital gain control ([SPK\\_GAIN](#)) settings are ignored.

#### Speaker Audio Processing Bypass Path

In applications where the audio processing in the main speaker path is not desired, the device provides a bypass path. The bypass path is selected with the [PCM\\_BYPASS\\_EN](#) bit field. The PCM data input channel for the speaker audio processing bypass path is selected with the [PCM\\_BYPASS\\_SOURCE](#) bit field.

### Bypass Path Data Inversion

The input data to the audio processing bypass path can optionally be inverted by setting the [BYP\\_INVERT](#) bit to 1. The input data to the audio processing bypass path can only be inverted when the DC blocking filter is also enabled by setting [SPK\\_DCBLK\\_EN](#) to 1.

### Bypass Path Dither

The input data to the audio processing bypass path can optionally have dither ( $\pm 1$ LSB peak-to-peak) applied if [SPK\\_DITH\\_EN](#) is set to 1. No dither is applied when [SPK\\_DITH\\_EN](#) is set to 0. The [SPK\\_DITH\\_EN](#) bit also controls the dither applied to the audio playback path.

### Bypass Path DC Blocking Filter

A DC blocking filter can be enabled on the audio processing bypass path by setting the [SPK\\_DCBLK\\_EN](#) bit to 1. The [SPK\\_DCBLK\\_EN](#) also controls the DC blocking filter in the audio playback path.

### Speaker Maximum Peak Output Voltage Scaling

The device operates over a large PVDD supply voltage range, and as a result the full-scale speaker amplifier output amplitude level is configurable to allow it to be scaled. As a baseline, the full-scale output of the speaker path DAC is 3.68dBV (typ). The speaker path no-load maximum peak output voltage level ( $V_{MPO}$ ) is then programmable relative to this baseline level. The peak output scaling range is from +4dB to +21dB, and is set with the [SPK\\_GAIN\\_MAX](#) bit field.

The speaker output signal level (in dBV) for a given digital input signal level (in dBFS) is calculated as follows:

$$\text{Output Signal Level (dBV)} = \text{Input Signal Level (dBFS)} + 3.68 \text{ (dBV)} + \text{SPK\_GAIN\_MAX (dB)}$$

(0dBFS is referenced to 0dBV)

The peak output voltage scaling is applied to the signal path using a combination of digital gain and analog gain adjustments.

### Dynamic-Headroom Tracking (DHT)

The device features dynamic-headroom tracking that can preserve consistent signal distortion and listening levels in the presence of a varying supply level. The DHT block provides both a dynamic range compressor (DRC) and limiter. The limiter can operate either as a signal distortion limiter (SDL) or a standard signal level limiter (SLL). Each of these three functions can be used independently (modes 1 through 3), and the SLL and DRC can be used simultaneously (mode 4). The DHT block is enabled with the [DHT\\_EN](#) bit. Prior to enabling the DHT, the measurement ADC, PVDD, and VBAT channels should be configured and enabled as required based on the amplifier mode of operation. The DHT block uses the measured supply levels and the current signal level to calculate the attenuation (if any) that is applied to the signal path. Also, the DHT block should not be disabled by setting [DHT\\_EN](#) bit to 0 when the DHT is active (i.e., attenuation is being applied).

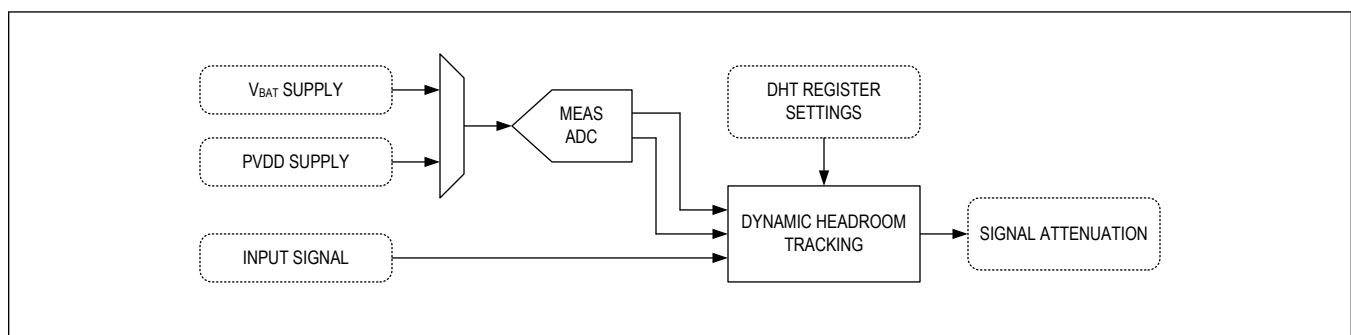

Figure 11. Simplified Dynamic-Headroom Tracking System Block Diagram

### DHT Supply Tracking and Headroom

The DHT block uses three parameters to track the target peak output level ( $V_{TPO}$ ) relative to the maximum peak output voltage ( $V_{MPO}$ ) as the active speaker amplifier supply level varies.

The first is the speaker amplifier full-scale gain setting ([SPK\\_GAIN\\_MAX](#) bit field). This control selects the maximum (no-load) peak output voltage level ( $V_{MPO}$ ) that is output by the Class-DG amplifier with a full-scale input signal (0dBFS). Most DHT thresholds and parameters are calculated relative to the full-scale  $V_{MPO}$ .

The second parameter is the measured speaker amplifier supply voltage level ( $V_{SUP}$ ). The measurement ADC provides the DHT block with the current supply voltage levels ( $V_{PVDD}$  and  $V_{VBAT}$ ). The DHT block decides which supply voltage to use for calculations based on the currently active speaker amplifier supply.

The third parameter is the speaker amplifier supply headroom ( $SUP_{HR}$ ). The supply headroom is a positive or negative percentage offset relative to the measured  $V_{SUP}$  conversion result. It is configured using the [DHT\\_HR](#) bit field, and can be set from +20% to -20% of  $V_{SUP}$  in 2.5% step sizes.

The DHT target peak output voltage level ( $V_{TPO}$ ) is equal to the measured supply voltage ( $V_{SUP}$ ) scaled to include the selected supply headroom percentage and is actively calculated with the following equation:

$V_{TPO} = V_{SUP} \times (100\% - SUP_{HR})$  The target peak output attenuation (or ratio) from  $V_{TPO}$  to  $V_{MPO}$  is calculated as follows:

$$A_{TPO} = 20 \times \log (V_{TPO}/V_{MPO})$$

If  $A_{TPO}$  exceeds 0dB ( $V_{SUP}$  with headroom  $> V_{MPO}$ ), then the DHT block assumes that there is sufficient supply voltage to reproduce the audio signals as configured without attenuation. In this case,  $A_{TPO} = 0$ dB is used for all further calculations. This is important as the DHT functions only ever apply attenuation and do not apply positive gain. Once the calculated  $V_{TPO}$  drops below  $V_{MPO}$ , the calculated target peak output attenuation ( $A_{TPO}$ ) is less than 0dB, and the DHT functions are applied appropriately as the input signal level changes.

For example, if  $V_{MPO} = 13.63$ V,  $V_{SUP} = 8.04$ V, and  $SUP_{HR} = -20\%$ , then solving for  $V_{TPO}$  yields a target peak output level of approximately 9.65V. Next, solving for the target peak output attenuation ( $A_{TPO}$ ) yields approximately -3dB.

[Figure 12](#) shows the default transfer function (with no DHT attenuation applied), where the current target peak output level ( $V_{TPO}$ ) is based on the current  $V_{SUP}$  and the supply headroom settings. The tracked  $V_{TPO}$  and the resulting peak output attenuation ( $A_{TPO}$ ) are then used in the attenuation calculations for the DHT functions. Note that this and all subsequent figures are not drawn to precise scale, and that the x-axis is input signal level (dBFS) on a linear scale, while the y-axis is peak output voltage level on a log scale.

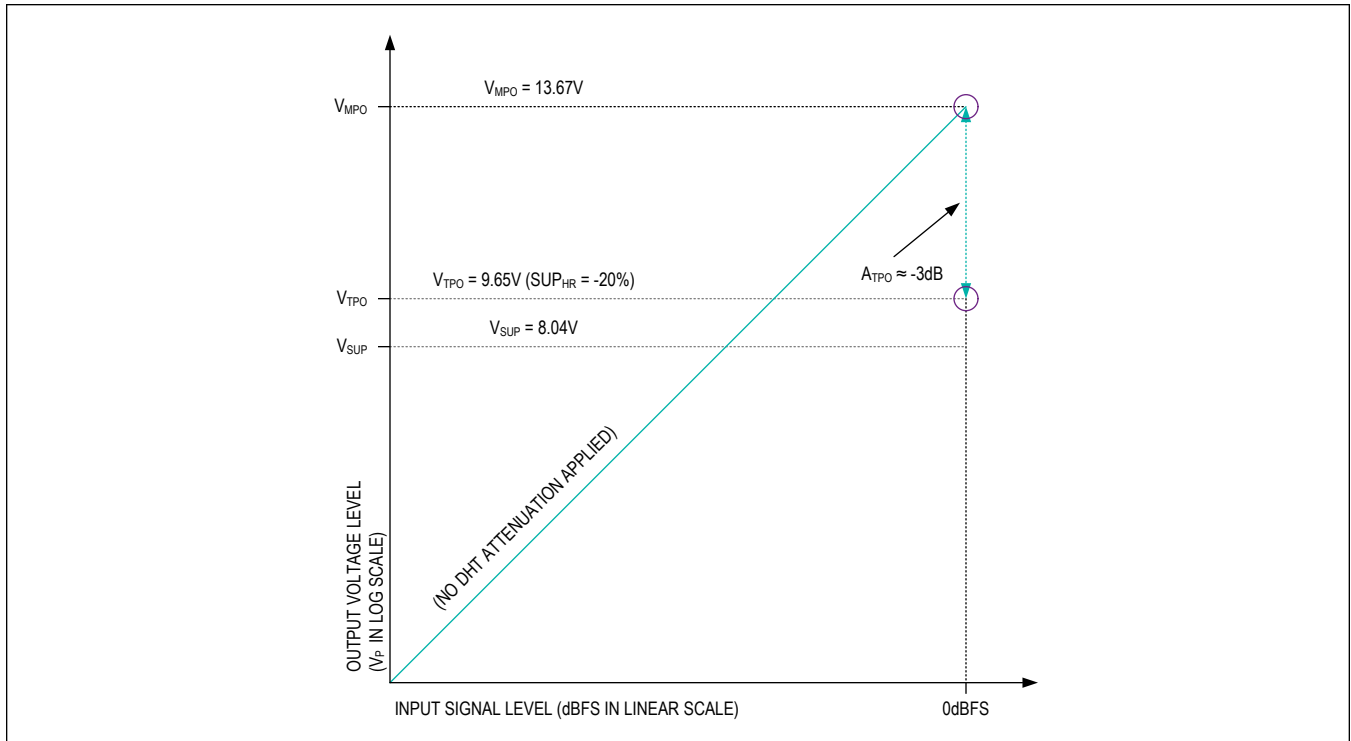

Figure 12. V<sub>TPO</sub> and A<sub>TPO</sub> Calculation Example

**DHT Mode 1 – Signal Distortion Limiter**

The DHT signal distortion limiter (SDL) maintains a consistent level of signal distortion at the amplifier output as the supply voltage (V<sub>SUP</sub>) changes. To use DHT mode 1 (just the signal distortion limiter active), set the *DHT\_LIM\_MODE* bit low (default) to place the limiter function in supply tracking mode (SDL), and set the dynamic range compressor rotation point (*DHT\_VROT\_PNT*) to 0dBFS (effectively disabling the DRC). The signal distortion limiter function is a compressor with a ratio of infinity to one that actively sets its threshold (V<sub>SDL</sub> in voltage) equal to the calculated target peak output voltage level (V<sub>TPO</sub>). The output referred SDL threshold (SDL<sub>THR</sub>) and the input referred SDL knee or rotation point (SDL<sub>RP</sub>) are equal in mode 1, and can be calculated relative to full-scale (in dBFS) as a ratio of V<sub>TPO</sub> to V<sub>MPO</sub>:

$$SDL_{RP} = SDL_{THR} = 20 \times \log(A_{TPO}) = 20 \times \log(V_{TPO} / V_{MPO})$$

The transfer function for input signal levels below the SDL rotation point (SDL<sub>RP</sub>) is unchanged. When the input signal level exceeds SDL<sub>RP</sub>, the signal distortion limiter function is applied to the signal path. As the input signal level increases, the distortion limiter attenuation continues to increase as well and can be calculated for a given input signal level (A<sub>INPUT</sub> in dBFS) as follows:

$$SDL \text{ ATTENUATION} = SDL_{RP} - A_{INPUT}$$

By actively recalculating SDL<sub>RP</sub> (or SDL<sub>THR</sub>) as the target peak output level (V<sub>TPO</sub>) changes, the DHT SDL maintains a consistent limit and level of amplifier output distortion relative to available supply voltage (V<sub>SUP</sub>).

When the target peak output voltage (V<sub>TPO</sub>) exceeds the amplifier maximum peak output voltage (V<sub>MPO</sub>) there is sufficient headroom and no SDL attenuation is applied. However, as soon as V<sub>TPO</sub> falls below V<sub>MPO</sub>, it is possible for the input signal amplitude to exceed the calculated SDL<sub>RP</sub>. The following examples show the transfer function when V<sub>SUP</sub> ≥ V<sub>MPO</sub> with the minimum (-20%), without (0%), and maximum (+20%) supply headroom (SUP<sub>HR</sub>) settings. Note that in the case with positive headroom (+20%), the SDL<sub>RP</sub> falls below the input signal full-scale level even though V<sub>SUP</sub> = V<sub>MPO</sub>.



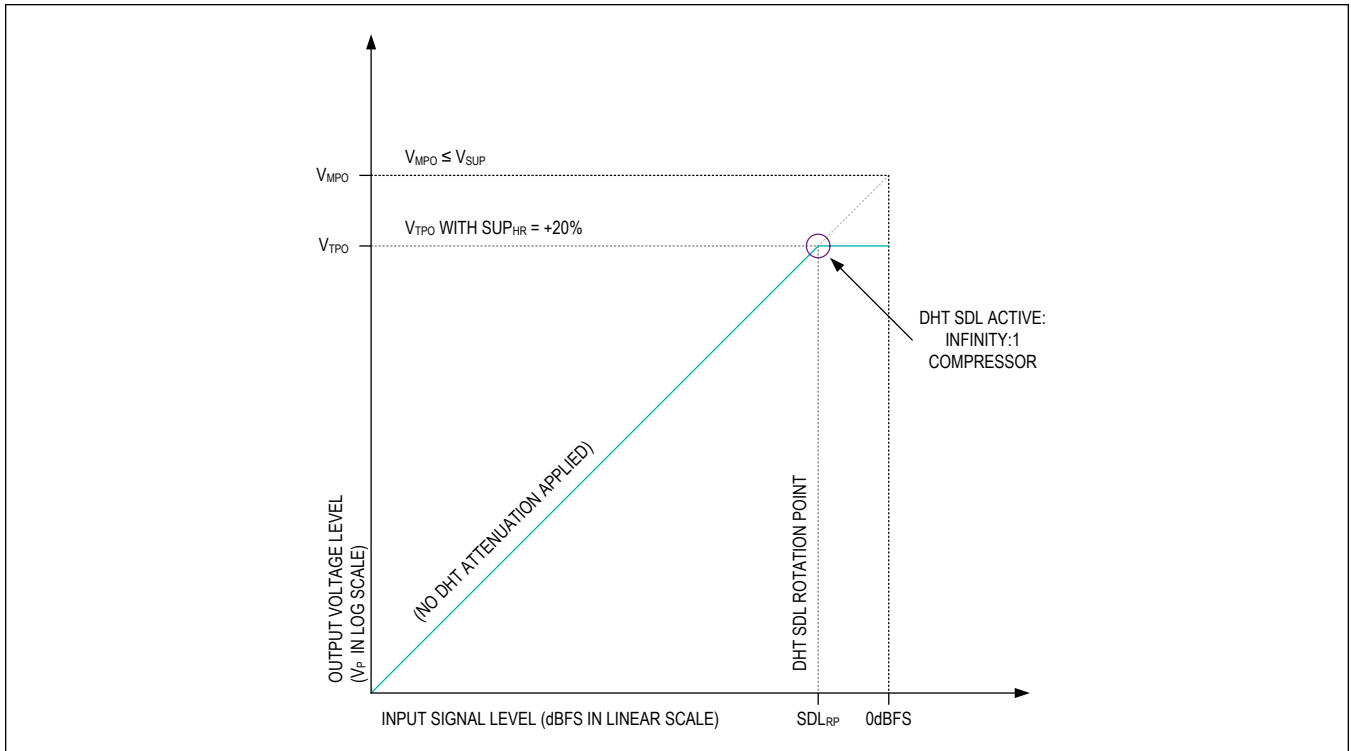

Figure 13. Signal Distortion Limiter with  $V_{MPO} \leq V_{SUP}$  and +20% Headroom ( $SUP_{HR}$ )

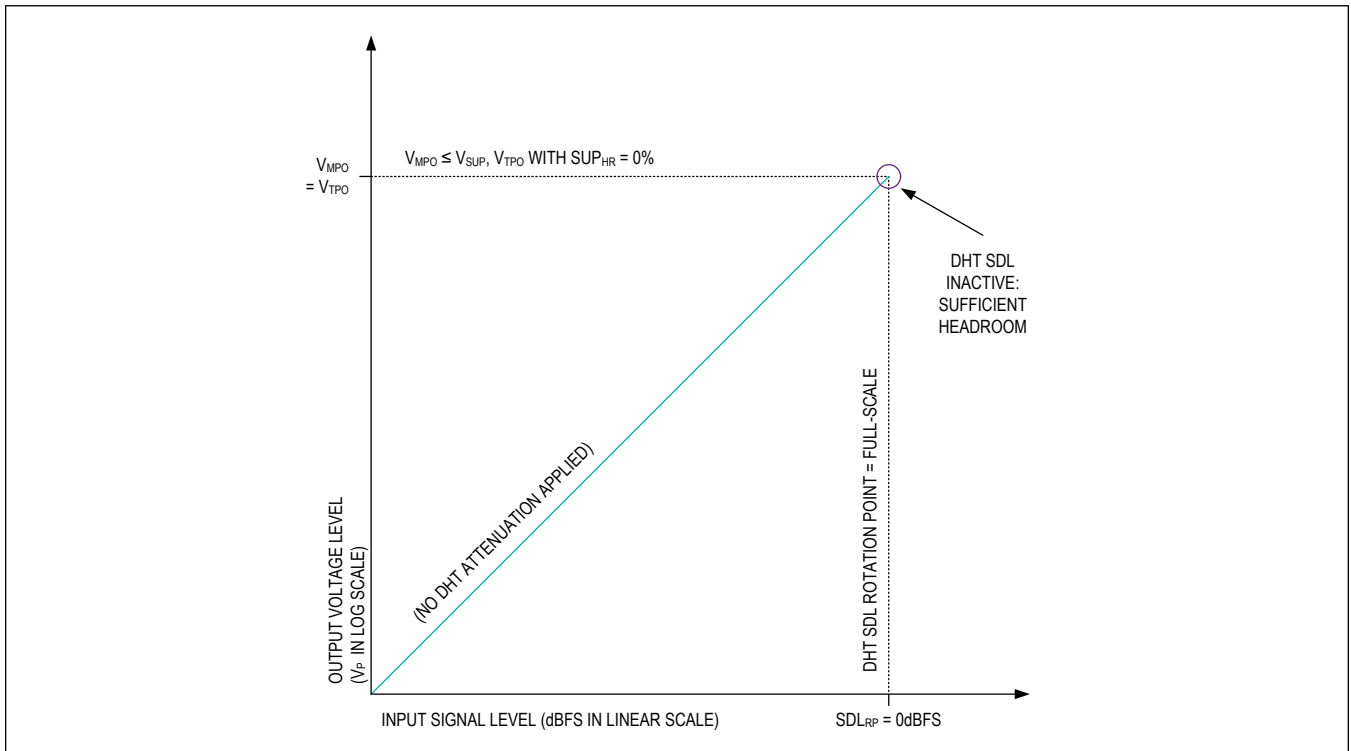

Figure 14. Signal Distortion Limiter with  $V_{MPO} \leq V_{SUP}$  and 0% Headroom ( $SUP_{HR}$ )

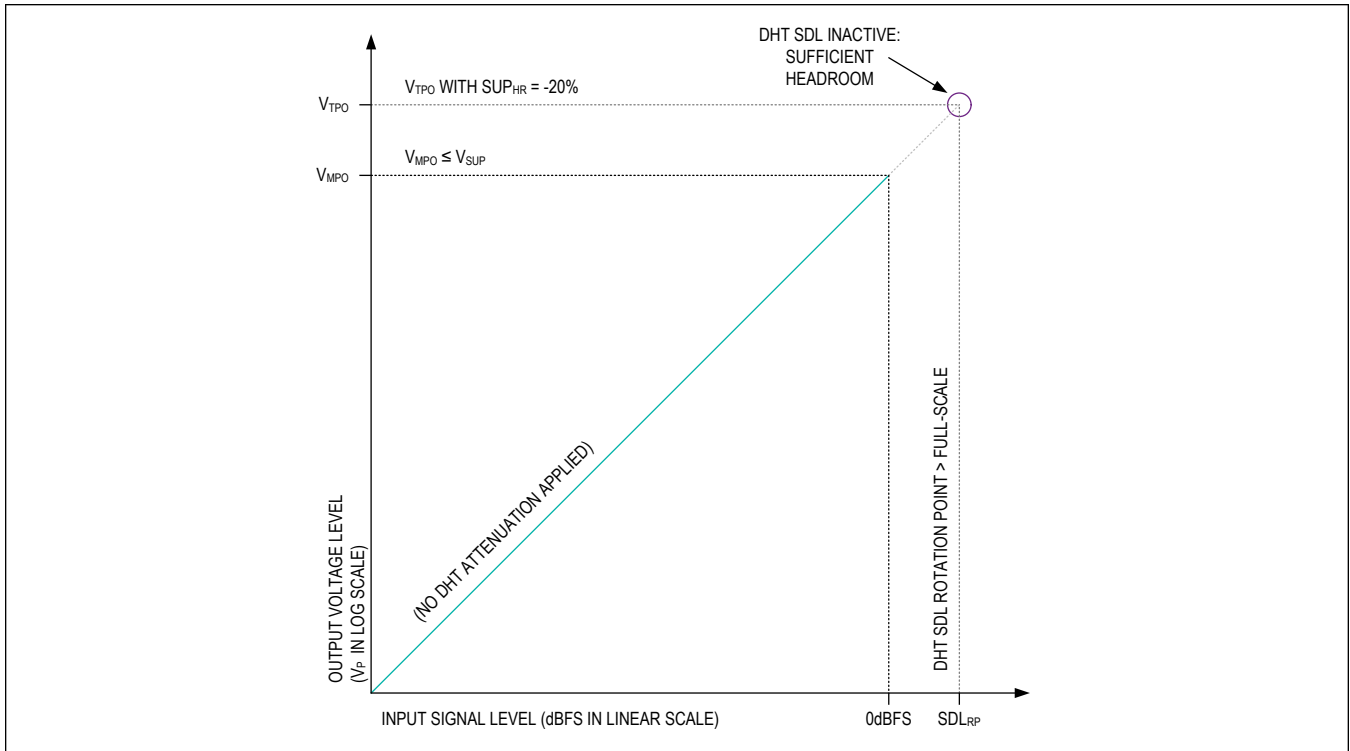

Figure 15. Signal Distortion Limiter with  $V_{MPO} \leq V_{SUP}$  and -20% Headroom ( $SUP_{HR}$ )

As the supply voltage ( $V_{SUP}$ ) drops further below the maximum peak output voltage ( $V_{MPO}$ ), the DHT target peak out voltage ( $V_{TPO}$ ) proportionally scales down. In cases with zero or positive amplifier supply headroom settings ( $+20\% \geq SUP_{HR} \geq 0\%$ ), the input signal level can exceed the SDL rotation point ( $SDL_{RP}$ ) before the peak output exceeds  $V_{SUP}$ . In this case, amplifier output clipping can be prevented.

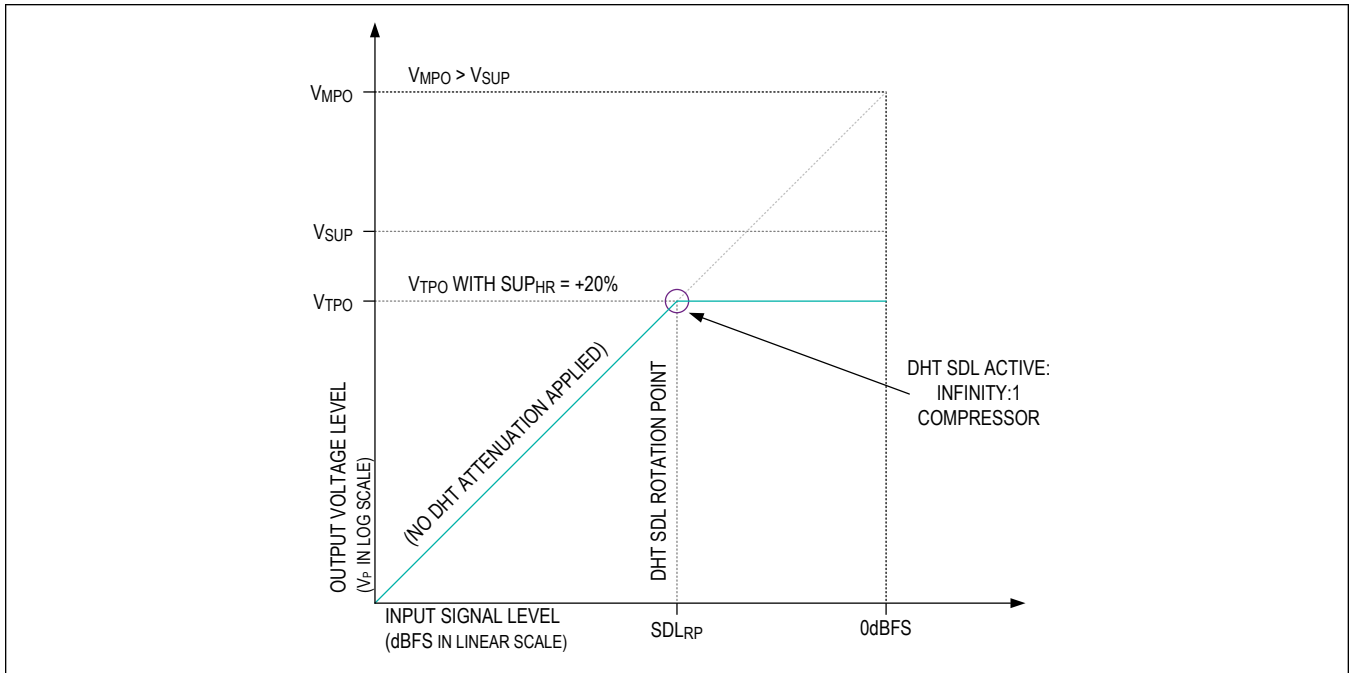

Figure 16. Signal Distortion Limiter with  $V_{MPO} > V_{SUP}$  and +20% Headroom ( $SUP_{HR}$ )

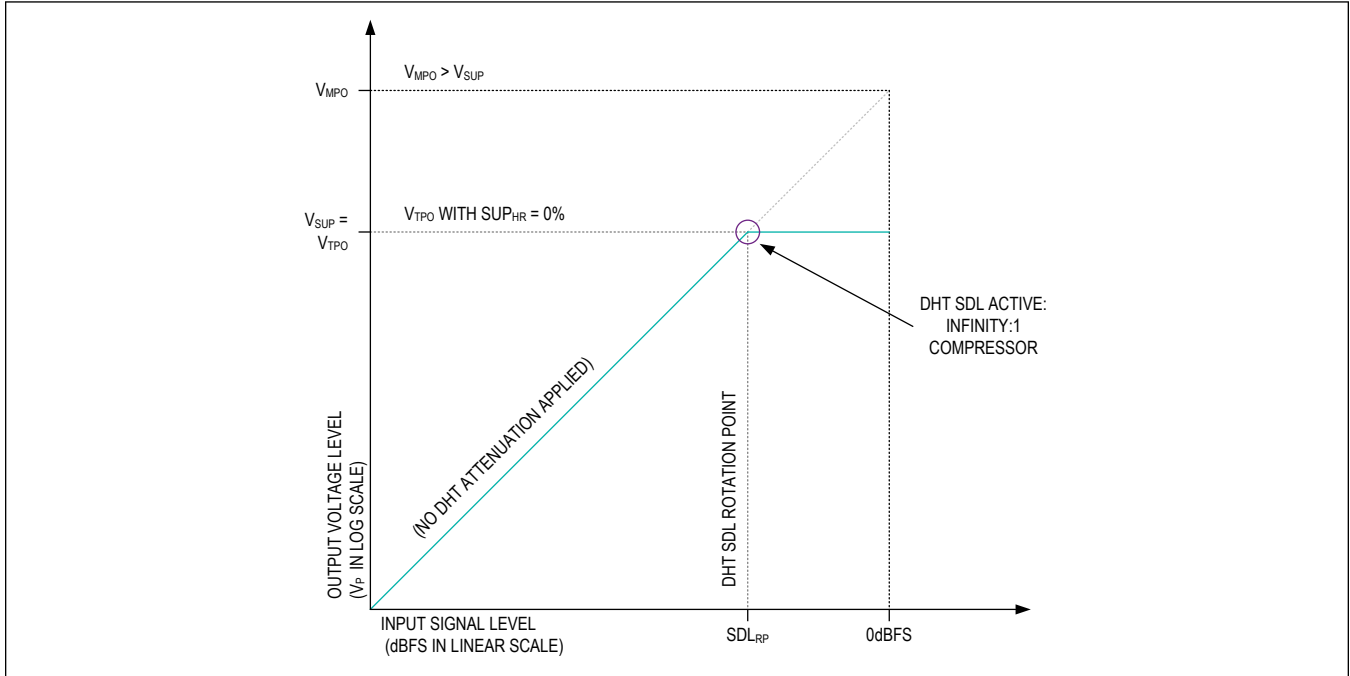

Figure 17. Signal Distortion Limiter with  $V_{MPO} > V_{SUP}$  and 0% Headroom ( $SUP_{HR}$ )

In cases with a negative supply headroom setting ( $0\% > SUP_{HR} \geq -20\%$ ), the input signal does not exceed the  $SDL_{RP}$  until after the peak output reaches  $V_{SUP}$ . As a result, clipping occurs at the amplifier output. However, once the input signal level exceeds the  $SDL_{RP}$ , the audio signal level is digitally limited by the SDL preventing the amplifier output clipping from worsening further.

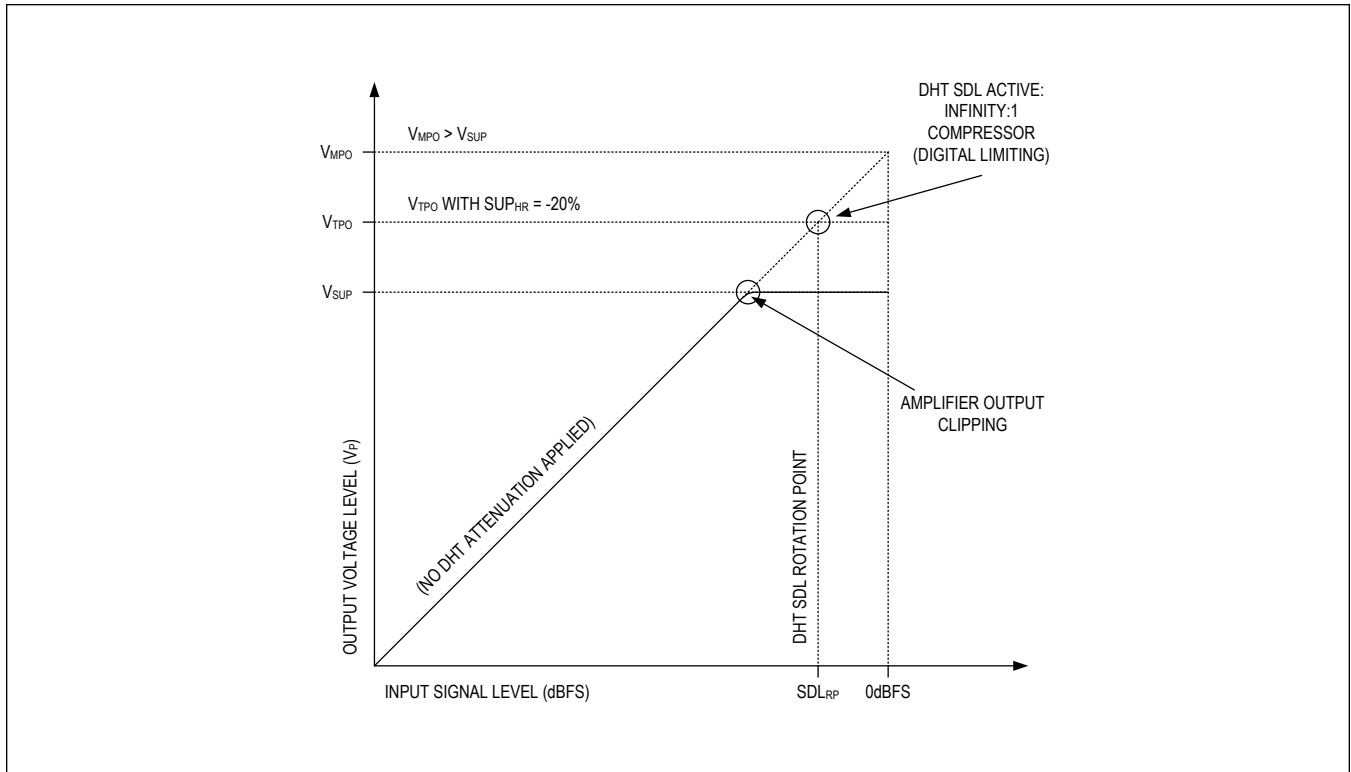

Figure 18. Signal Distortion Limiter with  $V_{MPO} > V_{SUP}$  and -20% Headroom ( $SUP_{HR}$ )

**DHT Mode 2 – Signal Level Limiter**

In DHT mode 2, the limiter is configured as a fixed threshold signal level limiter (SLL). Set the [DHT\\_LIM\\_MODE](#) bit high to place the limiter function in SLL mode, and set the dynamic range compressor rotation point to 0dBFS (effectively disabling the DRC).

Like the signal distortion limiter, the signal level limiter function is a compressor with a ratio of infinity to 1. However, unlike the SDL, the SLL output referred threshold ( $SLL_{THR}$ ) is configured to a set level. The  $SLL_{THR}$  is selected with the [DHT\\_LIM\\_THRESH](#) bit field from a range of 0dBFS to -15dBFS. The SLL threshold can also be expressed as an input referred knee or rotation point ( $SLL_{RP}$ ) which is equal to  $SLL_{THR}$  in mode 2. The SLL amplifier peak output voltage limit ( $V_{SLL}$ ) is calculated from the selected SLL threshold ( $SLL_{THR}$ ) and maximum peak output voltage ( $V_{MPO}$ ) with the following equation:

$$SLL \text{ PEAK OUTPUT VOLTAGE LIMIT} = V_{SLL} = V_{MPO} \times 10^{(SLL_{THR} / 20)}$$

The transfer function for signal levels below the SLL threshold ( $SLL_{THR}$ ) is unchanged. When the signal level exceeds the  $SLL_{THR}$ , the signal level limiter function is applied to the signal path. As the input signal level increases, the limiter attenuation continues to increase as well and can be calculated for a given input signal level ( $A_{INPUT}$  in dBFS) relative to  $SLL_{RP}$  (=  $SLL_{THR}$ ) as follows:

$$SLL \text{ ATTENUATION} = SLL_{RP} - A_{INPUT}$$

When  $V_{TPO}$  is greater than  $V_{SLL}$ , the amplifier peak output level is limited to  $V_{SLL}$  whenever the signal amplitude exceeds the SLL threshold ( $SLL_{THR}$ ). As a result of the fixed SLL threshold and rotation point, the transfer function is identical for any  $V_{SUP}$  level and corresponding  $V_{TPO}$  that is greater than  $V_{SLL}$ .

This is illustrated in [Figure 19](#) for decreasing  $V_{SUP}$  and  $V_{TPO}$  levels. As  $V_{SUP}$  decreases,  $V_{TPO}$  is recalculated and decreases as well. Three different progressively lower  $V_{TPO}$  levels are shown ( $V_{TPO1}$ ,  $V_{TPO2}$ , and  $V_{TPO3}$ ). Due to the fixed SLL threshold,  $V_{SLL}$  is the same in all three cases. Since all three  $V_{TPO}$  values are greater than  $V_{SLL}$ , the transfer function for each case is identical and is limited at  $V_{SLL}$ .

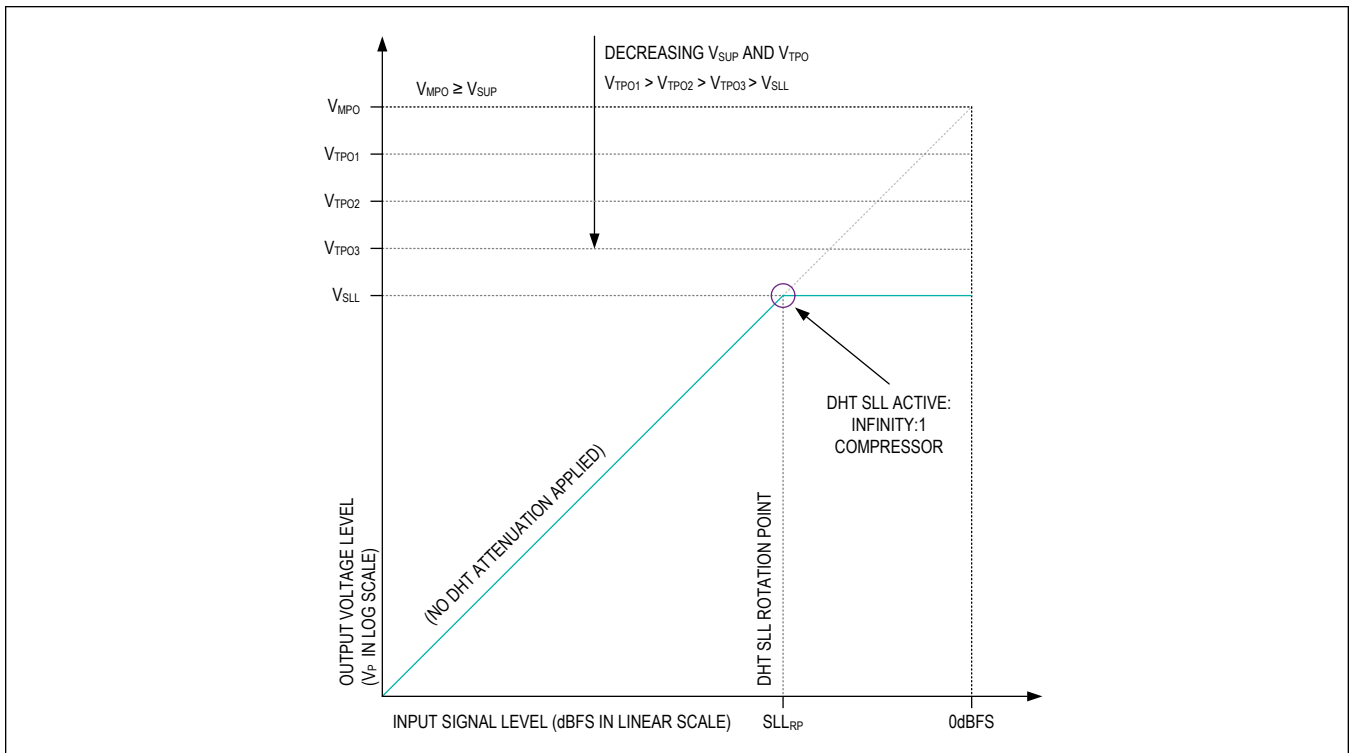

Figure 19. Signal Level Limiter with  $V_{TPO} > V_{SLL}$  as  $V_{SUP}$  Decreases

When  $V_{TPO}$  is less than  $V_{SLL}$ , the amplifier output can clip before the input signal amplitude exceeds the SLL rotation point ( $SLL_{RP} = SLL_{THR}$ ). As the input signal level continues to increase and exceed  $SLL_{RP}$ , the signal level is digitally limited which prevents the amplifier output clipping from worsening further. Because both the SLL threshold and rotation point are fixed relative to full-scale, the clipping at the amplifier output grows progressively worse prior to the input signal exceeding  $SLL_{RP}$  ( $= SLL_{THR}$ ) as  $V_{SUP}$  continues to decrease.

The following [[Signal Level Limiter with  $V_{TPO} < V_{SLL}$  Showing Amplifier Output Clipping]] has the same SLL settings as [Figure 19](#) (same  $SLL_{THR}$ ). For simplicity,  $V_{TPO} = V_{SUP}$  ( $SUP_{HR} = 0\%$ ), and  $V_{TPO}$  has decreased further and is now less than  $V_{SLL}$ . As a result, the amplifier output clips before the SLL digitally limits the signal level.

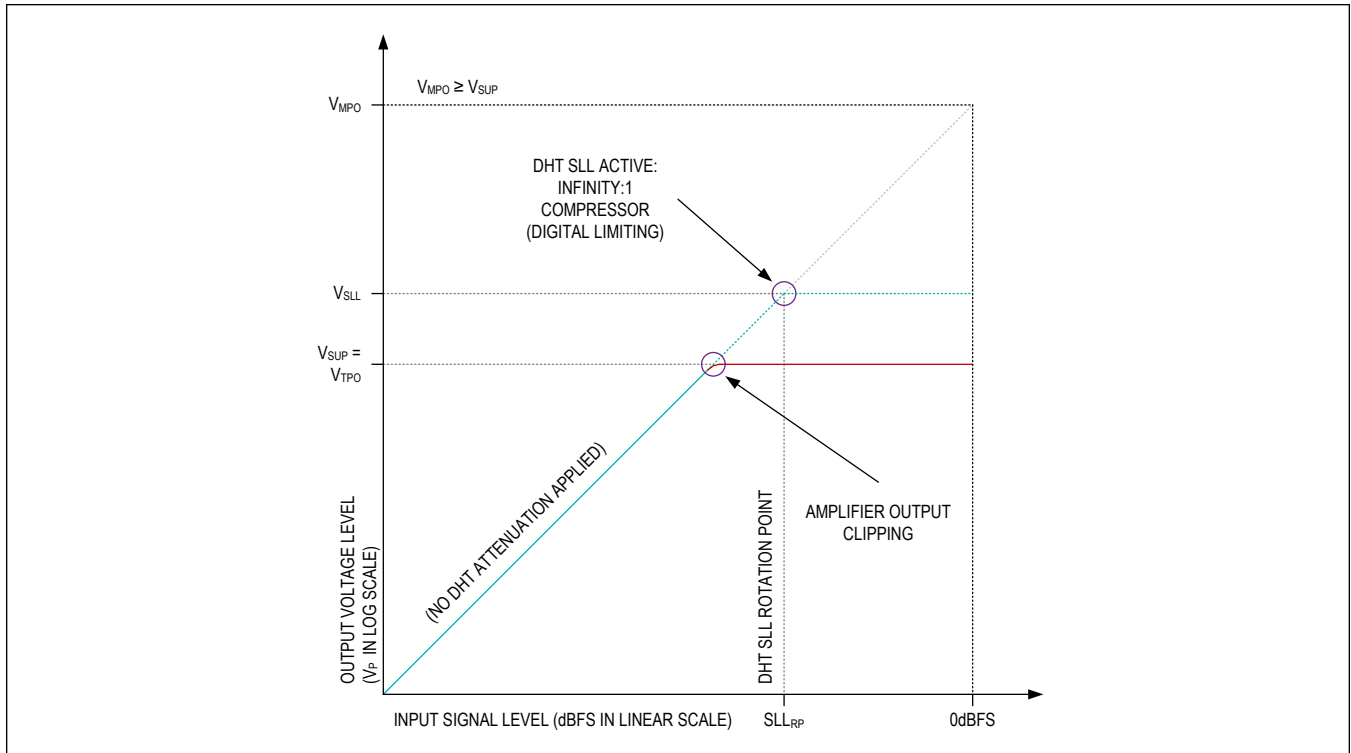

Figure 20. Signal Level Limiter with  $V_{TPO} < V_{SLL}$  Showing Amplifier Output Clipping

**DHT Mode 3: Dynamic Range Compressor**

The DHT dynamic range compressor (DRC) is configured by setting the input referred rotation point ( $DRC_{RP}$  in dBFS). The  $DRC_{RP}$  can be selected from a range from 0dBFS to -15dBFS with the [DHT\\_VROT\\_PNT](#) bit field. To calculate the DRC output referred voltage threshold ( $V_{DRC}$ ), use the following equation:

$$V_{DRC} = V_{MPO} \times 10^{(DRC_{RP}/20)}$$

For mode 3 operation, set the DRC rotation point ( $DRC_{RP}$ ) to any level lower than 0dBFS. Next, to disable limiter functions, place DHT into signal level limiter mode ([DHT\\_LIM\\_MODE](#) = 1) and set the fixed SLL threshold ( $SLL_{THR}$ ) to 0dBFS (using the [DHT\\_LIM\\_THRESH](#) bit field).

Once configured, the dynamic range compressor rotation point ( $DRC_{RP}$ ) is fixed at the selected level (or ratio) relative to the input full-scale. As  $V_{SUP}$  and  $V_{TPO}$  change, the DRC compression ratio for input signals that exceed  $DRC_{RP}$  changes as well. However, the transfer function remains unchanged for input signals below  $DRC_{RP}$ . If the amplifier is operating in class-G mode, it is recommended that the DRC rotation point ( $DRC_{RP}$ ) be set such that  $V_{DRC}$  exceeds the maximum possible VBAT voltage level. This ensures that DRC compression is only applied when PVDD is the active amplifier supply, and that the DHT cannot rapidly switch between two different ratios if the active amplifier supply toggles quickly.

The DHT tracks the target peak output voltage ( $V_{TPO}$ ) and attenuation ( $A_{TPO}$ ). As they change, the adaptive DRC compression ratio smoothly scales the listening level of the amplifier for any input signals that exceed  $DRC_{RP}$ . The DRC compression ratio is actively calculated with the following formula:

$$DRC \text{ COMPRESSION RATIO} = DRC_{RP} / (A_{TPO} - DRC_{RP})$$

The DRC attenuation for a given input signal level ( $A_{INPUT}$  in dBFS) is calculated as follows:

$$DRC \text{ ATTENUATION} = A_{TPO} - A_{INPUT} \times (A_{TPO} / DRC_{RP})$$

The following example shows the DRC transfer function with  $SUP_{HR} \geq 0\%$  as  $V_{SUP}$  (and thus  $V_{TPO}$ ) decreases. As the  $V_{TPO}$  level decreases (from  $V_{TPO1}$  to  $V_{TPO2}$  to  $V_{TPO3}$ ), the DRC compression ratio increases.

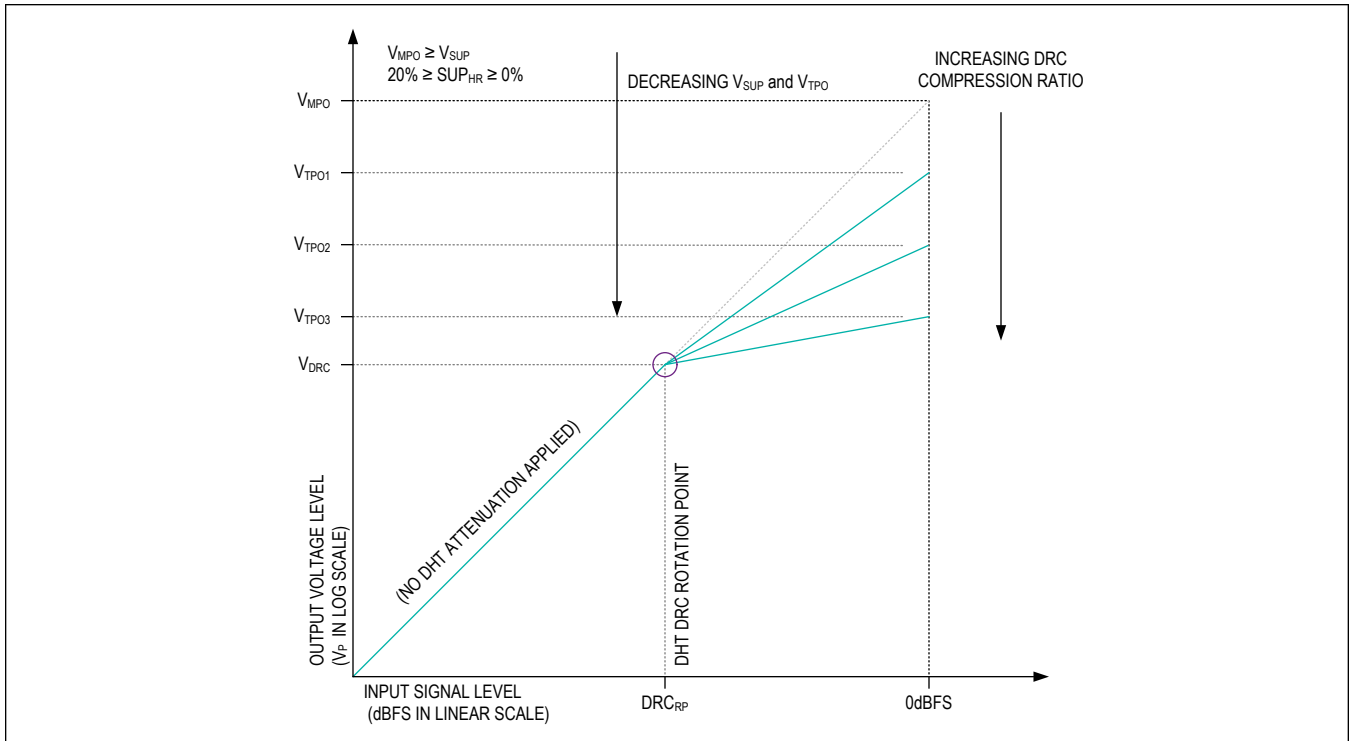

Figure 21. Dynamic Range Compression with Decreasing  $V_{SUP}$  and  $SUP_{HR} \geq 0\%$

Figure 22 shows the DRC transfer function with  $SUP_{HR} < 0\%$ . Due to the negative supply headroom,  $V_{TPO}$  is greater than  $V_{SUP}$  and the amplifier output clips before the input signal reaches full-scale.

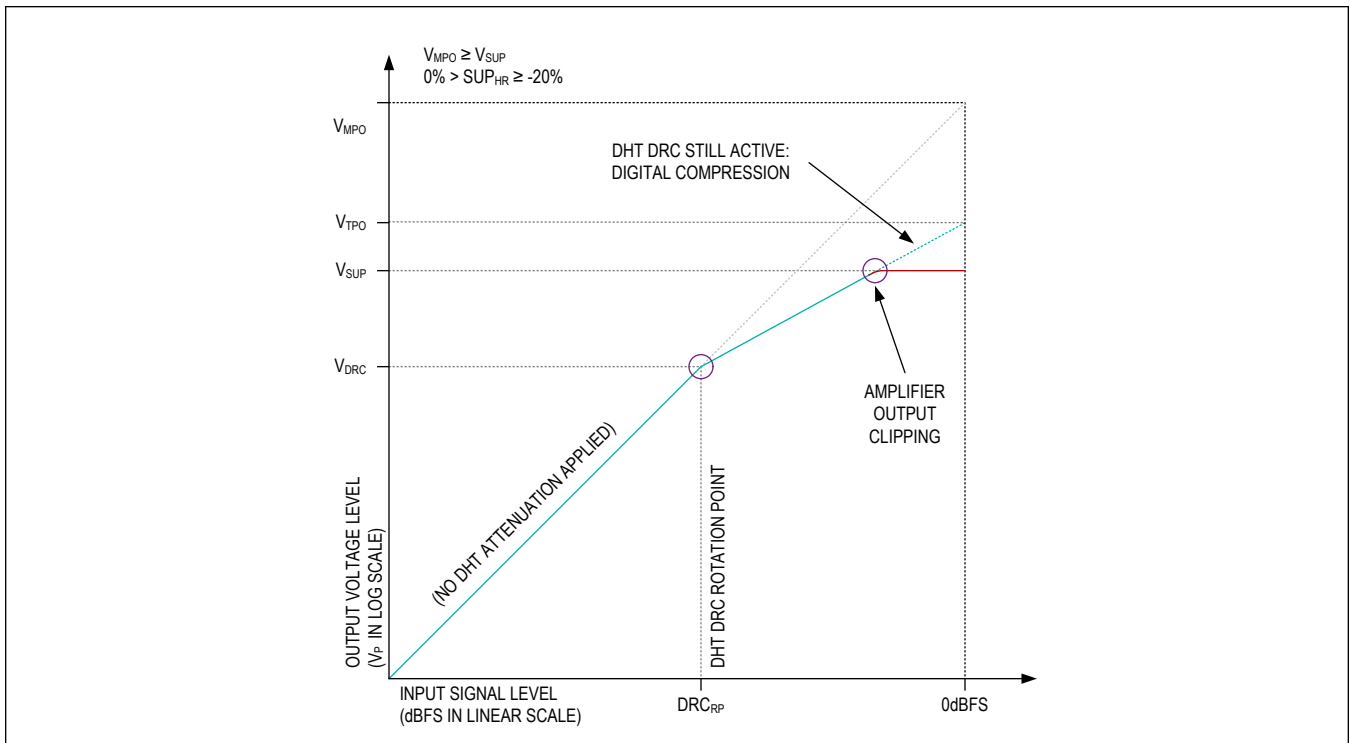

Figure 22. Dynamic Range Compressor with  $SUP_{HR} < 0\%$  and Output Clipping

#### DHT Mode 4: Dynamic Range Compressor with Signal Level Limiter

In DHT mode 4, the dynamic range compressor (DRC) and signal level limiter (SLL) are both enabled. The DRC rotation point ( $DRC_{RP}$ ) must be less than 0dBFS to enable mode 4. In addition, the DHT limiter function must be configured for SLL mode ( $DHT\_LIM\_MODE = 1$ ) with an SLL threshold ( $SLL_{THR}$ ) less than 0dBFS. Finally, to create a DHT response curve with both DRC and SLL inflection points, the SLL threshold ( $V_{SLL}$ ) must be greater than the DRC voltage threshold ( $V_{DRC}$ ). This insures that the resulting  $SLL_{RP}$  is always greater than the  $DRC_{RP}$ ; otherwise, the SLL limits the signal level before the DRC rotation point is ever reached.

Figure 23 shows three mode 4 transfer functions for three progressively lower  $V_{SUP}$  levels. The supply headroom is configured for  $SUP_{HR} > 0\%$  (positive supply headroom), and the calculated  $V_{TPO}$  value is falling such that  $V_{TPO1} > V_{TPO2} > V_{TPO3}$ . The DRC rotation point and SLL threshold are constant in all three cases, and  $SLL_{THR}$  is selected such that as  $V_{TPO}$  falls the SLL knee ( $SLL_{RP}$ ) is greater than the  $DRC_{RP}$ .

In the first two cases (for  $V_{TPO1}$  and  $V_{TPO2}$ ), the calculated SLL output voltage limit ( $V_{SLL}$ ) is less than  $V_{TPO}$ . As the signal level increases, it is first compressed by the DRC function then limited once the output level reaches  $V_{SLL}$ . In the third case, the SLL function is never applied since  $V_{SLL}$  is greater than  $V_{TPO3}$  and the signal level, while still compressed by the DRC, reaches full-scale before exceeding  $V_{SLL}$ .



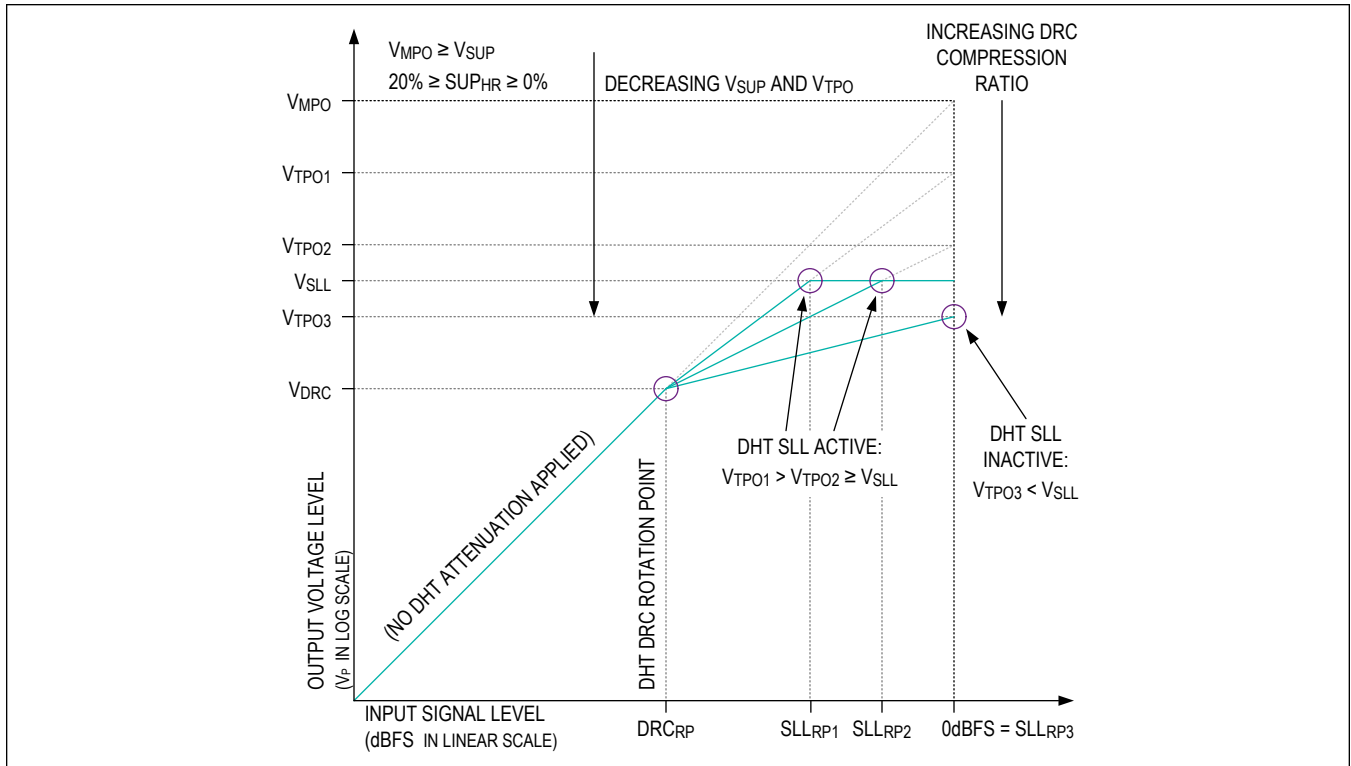

Figure 23. DHT DRC and SLL with Decreasing  $V_{SUP}$  ( $V_{TPO}$ ), and  $SUP_{HR} \geq 0\%$

Figure 24 shows a mode 4 transfer function where the supply headroom is negative ( $SUP_{HR} < 0\%$ ). As before, the SLL threshold ( $SLL_{THR}$ ) is programmed so that the resulting  $SLL_{RP}$  is greater than the  $DRC_{RP}$ . This also insures that the resulting  $V_{SLL}$  is greater than  $V_{DRC}$  and less than  $V_{TPO}$ . As the audio signal level increases, it is first compressed by the DRC function, then limited once the digital output signal level reaches  $V_{SLL}$ . However, due to the negative headroom, the amplifier output clips before the SLL function digitally limits the signal level.

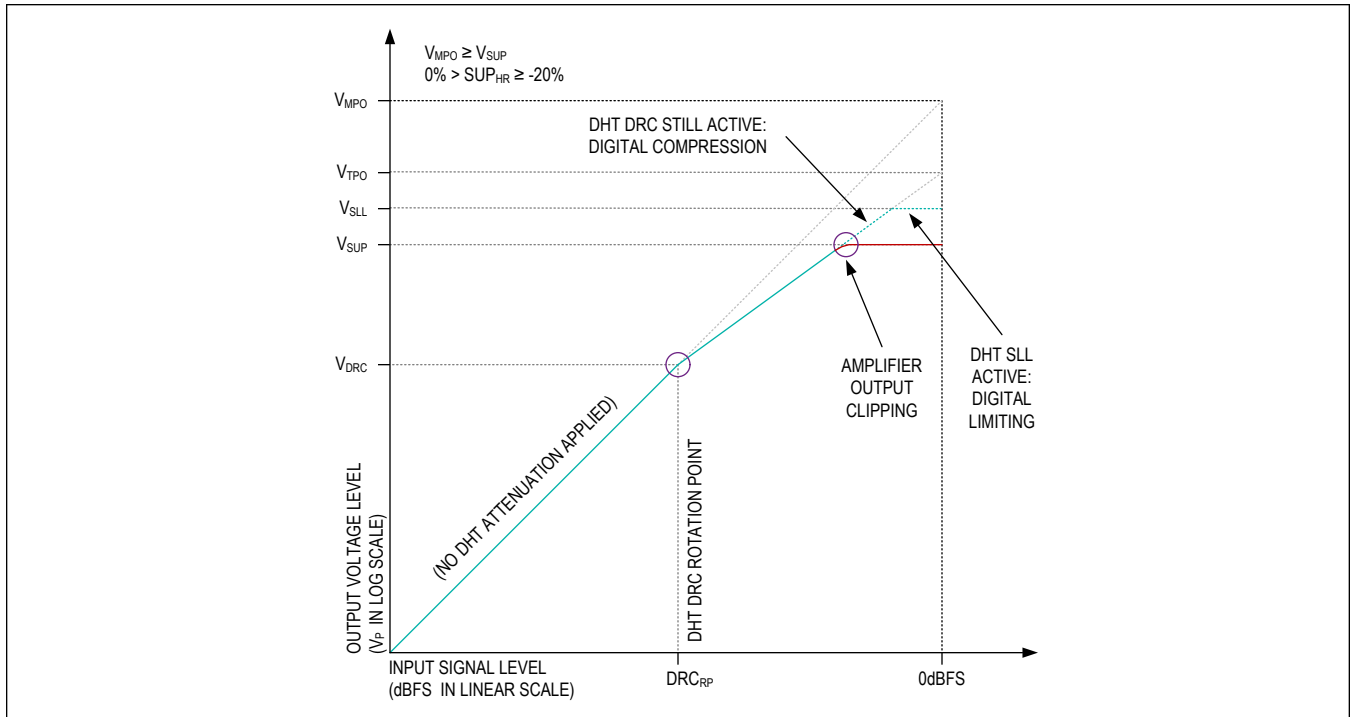

Figure 24. DHT DRC and SLL with Decreasing  $V_{SUP}$  ( $V_{TPO}$ ), and  $SUP_{HR} < 0\%$

### DHT Attenuation

An interrupt is generated ([DHT\\_ACTIVE\\_BGN\\_\\*](#)) when the DHT block first applies attenuation. When the DHT block fully releases all applied attenuation (i.e., DHT is inactive), an interrupt is generated ([DHT\\_ACTIVE\\_END\\_\\*](#)). Interrupts are not generated when DHT is actively adjusting the level of attenuation.

The maximum attenuation ( $A_{MAX}$ ) applied to the audio signal by the DHT functions is selected with the [DHT\\_MAX\\_ATN](#) bit field. The maximum attenuation can be set from -1dB to -15dB with a 1dB step size. The configured DHT functions stop further attenuation of the audio signal once the calculated attenuation (relative to the un-attenuated input signal level) reaches the selected maximum attenuation ( $A_{MAX}$ ). If the calculated attenuation (based on input signal level and measured  $V_{SUP}$ ) exceeds the selected maximum attenuation ( $A_{MAX}$ ), the applied attenuation is set equal to (limited at)  $A_{MAX}$ . This can occur anytime when the target peak output ( $V_{TPO}$ ) to maximum peak output ( $V_{MPO}$ ) ratio or peak output attenuation (denoted  $A_{TPO}$ ) is less than (or has a larger absolute value than)  $A_{MAX}$ .

All previous examples show cases where the peak output attenuation ( $A_{TPO}$ ) did not exceed the selected maximum attenuation ( $A_{MAX}$ ). The following figures show signal distortion limiter use cases where  $V_{SUP}$  has decreased until  $A_{TPO} < A_{MAX}$  (the DHT DRC function  $DRC_{RP}$  is set to  $0dBFS$  as in use case 1).

In [Figure 25](#), the  $SUP_{HR}$  is set to -20%. Since  $A_{TPO} < A_{MAX}$ , the attenuation applied by the distortion limiter reaches the programmed maximum attenuation level before the input signal reaches full-scale. For input signals past the point where calculated attenuation is equal to  $A_{MAX}$ , the attenuation stops increasing and is now fixed at  $A_{MAX}$ . As a result, the audio signal (in the digital domain) begins to increase past this point. This results in the distortion increasing at the amplifier output (which was already clipping at the limited level of distortion).

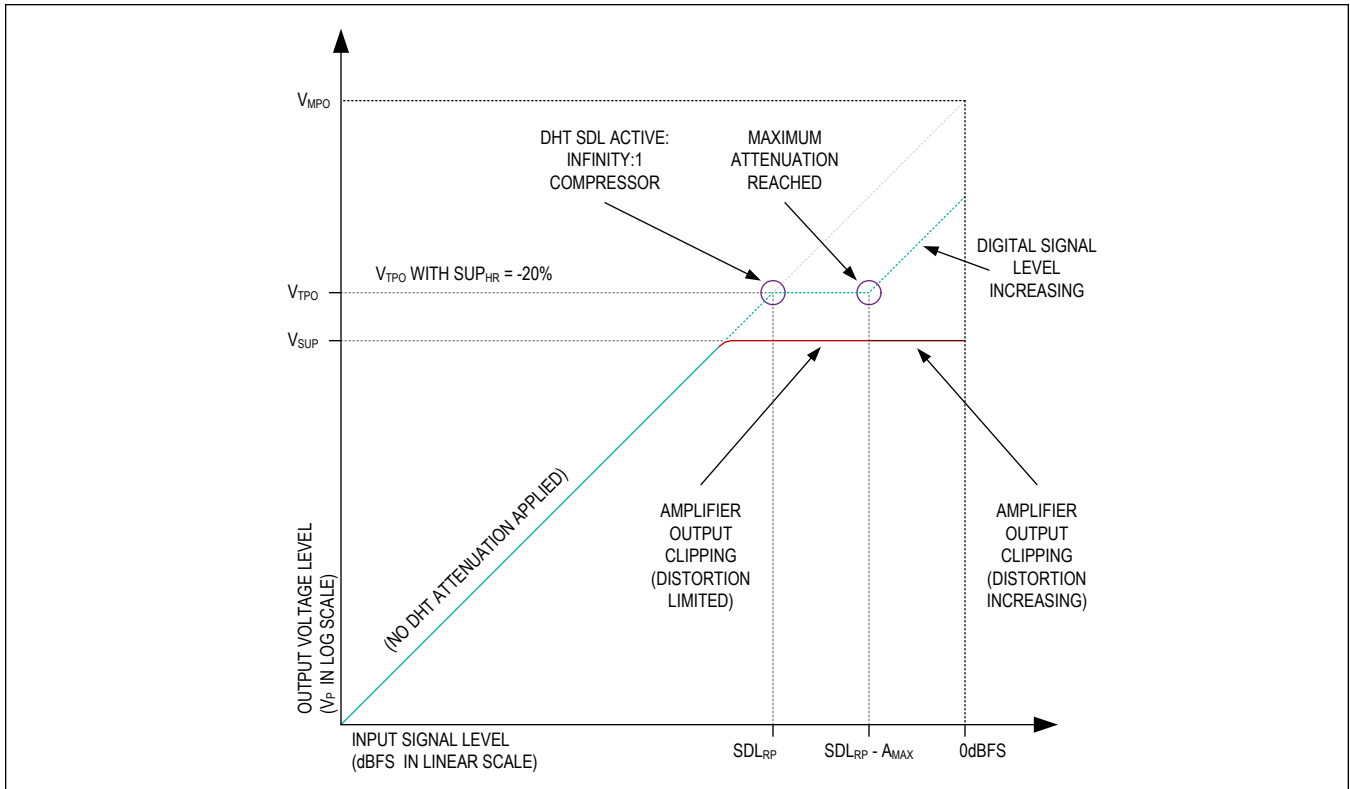

Figure 25. Distortion Limiter Case with -20% Headroom and  $A_{MAX}$  Exceeded

In Figure 26, the supply headroom is set to +20%. As before, the attenuation applied by the SDL reaches the selected maximum attenuation ( $A_{MAX}$ ) before the input signal reaches full-scale. The audio signal (in the digital domain) begins increasing past this point, and the signal level (and any distortion) at the amplifier output increases as well. In this case, the amplifier output was not clipping until after  $A_{MAX}$  was exceeded.

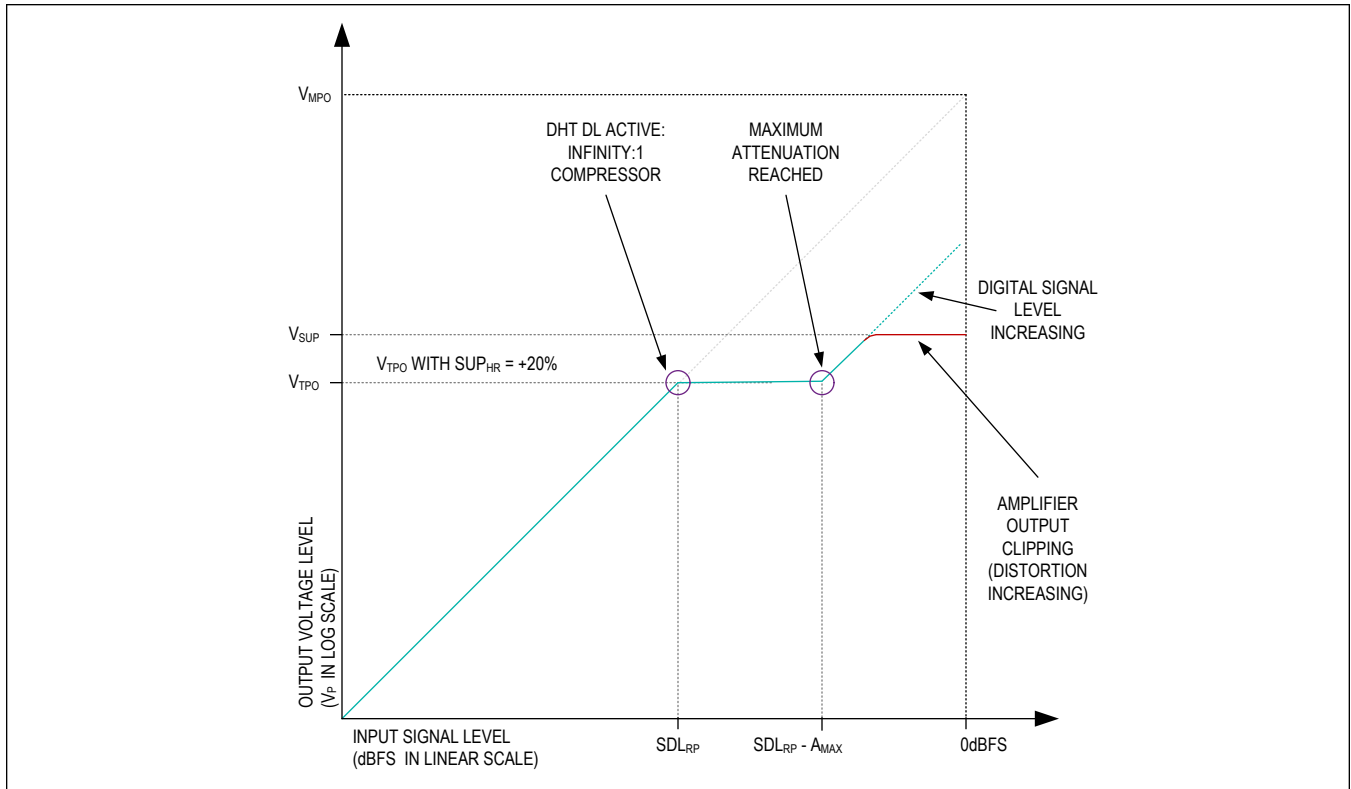

Figure 26. Distortion Limiter Case with +20% Headroom and  $A_{MAX}$  Exceeded

**DHT Attenuation Reporting**

In TDM mode, the current level of DHT attenuation is reported on the PCM data output (DOUT) when the DHT attenuation transmit enable bit is set high ( $PCM\_DHT\_ATN\_EN = 1$ ). The DHT attenuation level output is transmitted as a 14-bit unsigned binary attenuation level:

$$DOUT \text{ CURRENT DHT ATTENUATION (dB)} = 20 \times \log(14\text{-bit DOUT Value}/16383)$$

If enabled, the DHT attenuation target (in dB) is also shared between devices on the interchip communication (ICC) bus. In this case, the DHT attenuation level output requires two ICC output slots (8 bits each) and is transmitted as a 10-bit unsigned binary attenuation level (DHT\_ATN) followed by 6 bits of zero padding.

The current DHT attenuation (in dB) is calculated from the 10-bit value (DHT\_ATN) with the following equation:

$$ICC \text{ CURRENT DHT ATTENUATION (dB)} = - (DHT\_ATN[9:0] \times 0.015625\text{dB})$$

The current DHT attenuation level cannot exceed the selected DHT maximum attenuation ( $A_{MAX}$ ). Additionally, when the DHT is inactive, the reported attenuation is 0x0.

**DHT Ballistics**

When the signal level exceeds the rotation point or threshold for a configured DHT function (SDL, SLL, and/or DRC) or continues to increase beyond this point, the appropriate level of attenuation is applied to the signal level at the programmed attack rate. The DHT attack rate is selected with the  $DHT\_ATK\_RATE$  bit field.

The change in input signal level is detected by a peak detect circuit which has a fixed 3.5ms release time. When the signal level decreases or drops below the rotation point or threshold for a configured DHT function (SDL, SLL, and/or DRC), the appropriate level of applied attenuation is released. The DHT release rate is selected with the  $DHT\_RLS\_RATE$  bit field. However, due to the 3.5ms/dB peak detector, the 2ms/dB release rate is effectively 3.5ms/dB. All other release rates have a fixed delta of 3.5ms compared to the programmed release rate.

The attack and release behavior is slightly different when triggered by a change in active amplifier supply level. When the supply level decreases and triggers a DHT function attack, the attenuation is applied quickly at the configured attack rate. Likewise, as the supply level increases, the attenuation is released at the configured release rate. However, if DHT supply hysteresis is enabled ([DHT\\_SUPPLY\\_HYST\\_EN](#) = 1), then as the supply increases the applied DHT function does not release attenuation until the increase in the supply level exceeds the programmed DHT supply hysteresis level ([DHT\\_SUPPLY\\_HYST](#)). Once the supply increase exceeds the hysteresis, the appropriate level of applied attenuation is released at the configured release rate.

## Speaker Amplifier

The device features a Class-DG speaker amplifier output stage. The speaker amplifier playback path is enabled and disabled using the [SPK\\_EN](#) bit. The Class-DG multilevel amplifier generates a rail-to-rail output, pulse-width modulated (PWM) signal. By varying the PWM duty cycle, the amplifier modulates the output with the audio input signal. Because the switching frequency of the amplifier is 472kHz (typ) when the output signal is filtered by the speaker, only the audio component remains. Rail-to-rail operation ensures that power dissipation at the output is dominated by the on resistance ( $R_{ON}$ ) of the power output MOSFETs brief saturation current draw as the output switches as well as the current draw necessary to charge the output stage gates.

## Speaker Amplifier Operating Modes

The speaker amplifier can operate both in Class-DG and standard Class-D modes. In Class-DG mode, the amplifier output supply rail is switched between  $V_{PVDD}$  and  $V_{VBAT}$  based on the signal level. If Class-DG operation is disabled, the amplifier operates as a fixed supply Class-D amplifier and can be configured to use either  $V_{PVDD}$  or  $V_{VBAT}$  as the output supply rail. The speaker amplifier operating mode is selected with the [SPK\\_MODE](#) bit field.

### Class-DG Mode Enabled

Class-DG is the default speaker amplifier mode of operation ([SPK\\_MODE](#) = 0x0). In this mode, the amplifier switches the supply rail between PVDD and VBAT as needed to efficiently supply the required output power.

Additionally, if  $V_{VBAT}$  drops below the programmed threshold level [VBATLOW\\_OK\\_LVL](#) bit field, the amplifier operates from PVDD supply rail regardless of signal level.

The Class-DG signal level threshold ([VDG\\_THR](#)) at which the amplifier switches between the supply rails is programmable. The method used to program the signal level threshold is selected with the [SPK\\_DG\\_SEL](#) bit field. When [SPK\\_DG\\_SEL](#) is set to 0x0, the threshold ([VDG\\_THR](#)) is set to a fixed peak voltage level with the [SPK\\_DG\\_THRES](#) bit field. When [SPK\\_DG\\_SEL](#) is set to 0x1 (default), the threshold ([VDG\\_THR](#)) is variable relative to the current VBAT voltage (measurement ADC result). The peak voltage headroom relative to  $V_{VBAT}$  is configured with the [SPK\\_DG\\_HEADROOM](#) bit field. Finally, if [SPK\\_DG\\_SEL](#) is set to 0x2, the threshold ([VDG\\_THR](#)) is set based on whichever setting ([SPK\\_DG\\_THRES](#) or [SPK\\_DG\\_HEADROOM](#)) results in the lowest threshold for the current  $V_{VBAT}$  voltage level. As a result, as  $V_{VBAT}$  decreases, [VDG\\_THR](#) might transition from a fixed threshold to a lower  $V_{VBAT}$  headroom based variable threshold.

The Class-DG mode hold time is configured with the [SPK\\_DG\\_HOLD\\_TIME](#) bit field. VBAT is selected as the active amplifier supply to save power when the signal level drops below the threshold for longer than hold time. The amplifier switches to the VBAT supply only at signal zero cross, so the measured hold time is the register configured hold time plus the time taken for a zero cross event to occur. When VBAT is the active amplifier output supply, the [LV\\_EN](#) output asserts high. When the signal level rises above the threshold, the amplifier supply quickly switches to PVDD to provide higher output voltage swing and to avoid clipping. When PVDD is the active amplifier output supply, the [LV\\_EN](#) output asserts low.

### Delay for DG Mode

When the amplifier is operating in the automatic Class-DG mode, to avoid the potential for clipping the output signal as the PVDD supply rises, there is a programmable delay in the signal path controlled by [SPK\\_DG\\_DELAY](#). This allows the PVDD supply time to increase the output voltage before it is required to output larger signals.

### Class-DG Mode Disabled

When Class-DG mode is disabled, the speaker amplifier operates in standard Class-D mode. In this case, the active amplifier output supply is configured to either PVDD ([SPK\\_MODE = 0x1](#)) or VBAT ([SPK\\_MODE = 0x2](#)).

If the active amplifier output supply is configured to VBAT ([SPK\\_MODE = 0x2](#)), the amplifier operates from VBAT regardless of signal level. In this mode, the LV\_EN pin is asserted high.

When the active amplifier supply is set to PVDD, the amplifier always operates from PVDD regardless of the signal and supply levels. Furthermore, PVDD can be actively regulated between any levels within its standard operating range (3V to 20V) to save power. In this mode, LV\_EN pin is always asserted low.

### NOVBAT Mode

By default, the PVDD and VBAT pins must be supplied with external supplies for the amplifier to operate. In systems where the VBAT pin cannot be supplied by an external supply, the device can still operate from PVDD supply only by programming the [NOVBAT](#) bit field to 1. Additionally, the VBAT pin must be shorted to the VREFC pin on the PCB. When [NOVBAT](#) bit field is set to 1, the amplifier automatically operates in PVDD mode and the [SPK\\_MODE](#) bits have no effect.

### IDLE Mode

In customer systems where an external LC filter is used for EMI reduction, the quiescent power consumption and power consumption in Class-DG mode for low signal levels can be reduced by setting the IDLE\_MODE\_EN bit field to 1. The idle mode setting is not intended for operation in PVDD mode (with VBAT pin supplied externally) or NOVBAT mode (when the VBAT pin is not supplied externally) and therefore should not be enabled.

When the idle mode is enabled, the idle mode activates whenever the amplitude of the input audio data to the speaker path (from the PCM interface) is below the configured mute threshold ([MUTE\\_THRESH](#)) for more than 1024 consecutive data samples. When the idle mode is active, the current and voltage sense ADC paths output zero code data. The idle mode deactivates immediately if the amplitude of a single sample from the input audio data exceeds the configured unmute threshold ([UNMUTE\\_THRESH](#)). When the idle mode deactivates, the current and voltage sense ADC paths resume operation and output data normally.

The idle mode mute and unmute threshold settings are selected in terms of the number of bits (starting from the LSB) that must be toggling (or active) in order for the input signal amplitude to exceed the thresholds. It is invalid to set the noise gate unmute threshold ([MUTE\\_THRESH](#)) such that it is less than the configured mute threshold ([MUTE\\_THRESH](#)). The location of the audio data LSB within the PCM input data channel is determined by the configured PCM data word size ([PCM\\_CHANSZ](#)). The supported combinations are shown in [[Noise Gate/Idle Mode Threshold LSB Location By Input Data Configuration]]. It is not valid to enable the idle mode and noise gate function simultaneously.

### Speaker Amplifier Ultra-Low EMI Filterless Operation

Traditional Class-D amplifiers require the use of external LC filters or shielding to meet electromagnetic-interference (EMI) regulation standards. However, the device features emissions limiting circuitry that limits the output switching harmonics that can directly contribute to EMI and radiated emissions.

The programmable speaker amplifier edge rate control bits are used to adjust the switching edge rate to help tune EMI performance. As the edge rate increases, the efficiency improves slightly, while as the edge rate is decreased, the efficiency drops slightly. The speaker amplifier edge rate is configured with the [SPK\\_SL\\_RATE\\_GMODE](#), [SPK\\_SL\\_RATE\\_LS](#), and [SPK\\_SL\\_RATE\\_HS](#) bit fields.

The speaker amplifier output also supports spread-spectrum modulation (SSM). SSM is enabled by default to optimize the suppression and control of the output switching harmonics that can contribute to EMI and radiated emissions. The modulation index in spread-spectrum mode is controlled by the [SPK\\_SSM\\_MOD\\_INDEX](#) bit field, and the maximum modulation index (MMI) varies accordingly. Higher percentage settings of the modulation index result in the switching frequency of the amplifier being modulated by a wider range, spreading out-of-band energy across a wider bandwidth. Above 10MHz, the wideband spectrum looks like noise for EMI purposes.

### Speaker Amplifier Overcurrent Protection

The device features amplifier current limit protection that protects the amplifier output from both high current and short circuit events. If the [OVC\\_AUTORESTART\\_EN](#) bit is set to 1 and the speaker amplifier output current exceeds the current limit threshold (6.2A min), the device generates an interrupt and disables the amplifier output. After approximately 20ms, the amplifier output is re-enabled. If the overcurrent condition still exists, the device continues to disable and re-enable the amplifier output automatically until the fault condition is removed.

If the [OVC\\_AUTORESTART\\_EN](#) bit is set to 0, the device still generates an interrupt and disables the amplifier output when a speaker amplifier overcurrent event occurs. However, in this case the device is placed into software shutdown and the software enable ([EN](#)) bit is set to 0. As a result, the host must manually re-enable the device after an overcurrent event.

### Speaker Current and Voltage Sense ADC Path

The device provides two separate 16-bit ADCs to monitor the speaker amplifier output current and voltage (the I/V sense ADC path). The current and voltage ADC paths are independently enabled with the [IVADC\\_I\\_EN](#) and [IVADC\\_V\\_EN](#) bits, respectively.

The voltage and current digital data output are routed to the host through the PCM interface data output (DOUT), which is enabled by the [PCM\\_TX\\_EN](#) bit field. Both I and V data can be formatted in 16-/24-/32-bit 2's complement format and has a voltage sense range of  $\pm 22V$ , and a current sense range of  $\pm 6.5A$ .

When configured in 16-bit mode for Vsense, if MSB is 0 then the voltage would be  $11/(2^{15}) \times \text{DIG CODE}$ .

For example, a Vsense reading of 0111 1111 1111 1111 translates to a voltage of +22V and a reading of 1000 0000 0000 0000 would be -22V.

For 16-bit Isense, if MSB is 0, then the current would be  $3/(2^{15}) \times \text{DIG CODE}$ .

For example, an Isense reading of 0111 1111 1111 1111 translates to a voltage of +6.5A and a reading of 1000 0000 0000 0000 would be -6.5A.

See the [PCM Interface](#) section for details on configuring I/V sense-data output on DOUT. Both the current and voltage sense ADC output data can optionally have dither applied ( $\pm 1$  LSB peak-to-peak) by setting the [IVADC\\_DITH\\_EN](#) bit field to 1. No dither is applied when [IVADC\\_DITH\\_EN](#) is set to 0.

The I/V sense ADC path provides separate optional DC blocking filters (first-order highpass) in the current and voltage sense paths. The current and voltage path filters are enabled by setting the [IVADC\\_I\\_DCBLK\\_EN](#) and [IVADC\\_V\\_DCBLK\\_EN](#) bit fields to 1, respectively.

To ensure phase alignment, the current and voltage sense ADCs should be enabled either with a single write to the [IVADC\\_I\\_EN](#) and [IVADC\\_V\\_EN](#) bits ([EN](#) = 1) or by setting both bits high before exiting software shutdown. Additionally, all feedback channels (VMON, IMON, and [DSP feedback data](#)) are nominally in phase except for LRCLK sample rates of 88.2kHz/176.4kHz. For 88.2kHz/176.4kHz sample rates, VMON/IMON data is 180 degrees out of phase with the [DSP feedback data](#).

When laying out the PCB, the OUTPSNS and OUTNSNS pins should be Kelvin connected as close as possible to the load connected between OUP and OUTN for accurate voltage measurements. If a filter comprised of a ferrite bead and capacitor is installed between the speaker amplifier output pins and the load, then the sense lines should be connected between the filter and the load and as close to the load as possible. If an LC filter is installed between the amplifier output pins and the load, the OUTPSNS and OUTNSNS lines should be connected to the OUP and OUTN lines before the filter. The OUTPSNS and OUTNSNS pins are not intended to be driven by an external source. The speaker amplifier current is measured internally and requires no external connections.

### Brownout-Prevention Engine

The brownout-prevention engine (BPE) allows the device to reduce its contribution to the overall system power consumption by attenuating the amplifier output when the supply drops below a set of programmable thresholds. The BPE is enabled and disabled using the [BPE\\_EN](#) bit. The BPE can be enabled at any time by setting the [BPE\\_EN](#) bit



high. However, the BPE must not be disabled when it is active (in critical supply levels 0 through 3). The BPE can be disabled safely at any time that it is inactive. The input to the BPE controller is selected using the [BPE\\_SRC\\_SEL](#) bit. By default, the input to the BPE controller is the measurement ADC PVDD channel. If the selected measurement ADC channel is not already active, enabling the BPE will automatically enables it. The sample rate and filter settings for the measurement ADC determine the speed at which the BPE updates.

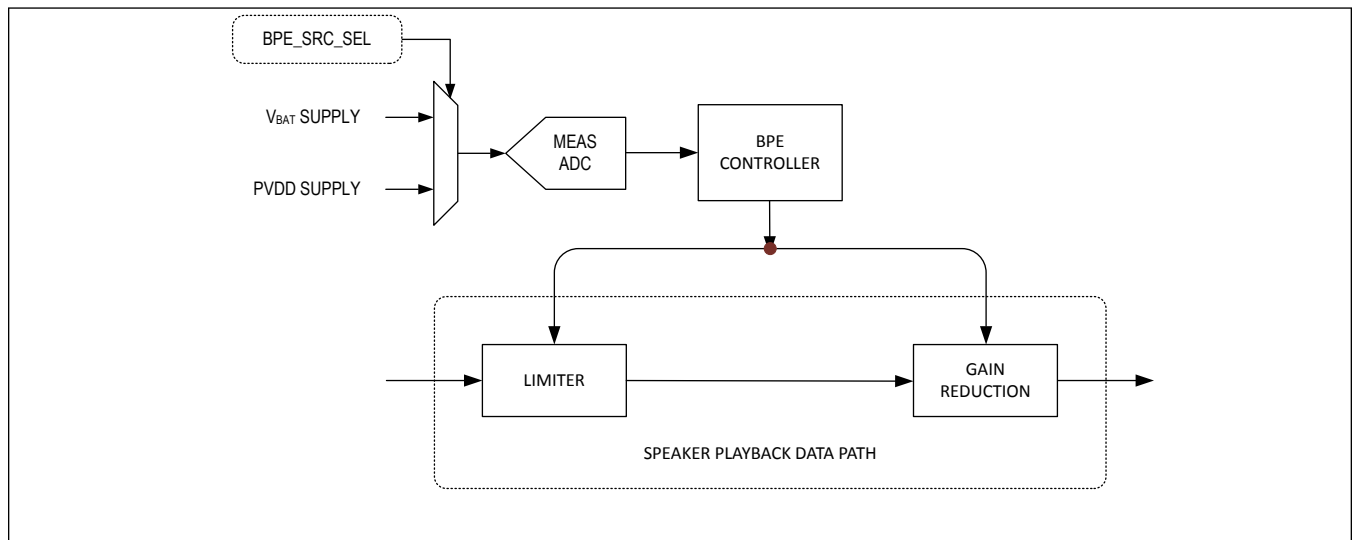

Figure 27. BPE Block Diagram

**BPE State Controller and Level Thresholds**

There are a total of four BPE critical supply levels, each with individually programmable thresholds. The thresholds for each level are configured with the [BPE\\_L0\\_VTHRESH](#) to [BPE\\_L3\\_VTHRESH](#) bit fields respectively. The BPE state controller monitors the measurement ADC channel results and automatically makes state changes.

**Table 9. Brownout-Prevention Engine Levels**

THRESHOLD NAME	CONDITION
BPE Inactive	VSUPPLY > Critical Supply Level 3
Critical Supply Level 3	Critical Supply 3 ≥ VSUPPLY > Critical Supply Level 2 + Hysteresis
Critical Supply Level 2	Critical Supply Level 2 ≥ VSUPPLY > Critical Supply Level 1 + Hysteresis
Critical Supply Level 1	Critical Supply Level 1 ≥ VSUPPLY > Critical Supply Level 0 + Hysteresis
Critical Supply Level 0	VSUPPLY ≤ Critical Supply Level 0

The brownout engine supports hysteresis on the levels. This behaves as follows:

- When in level N, transition to level N + 1 when VSUPPLY stays above (level N threshold) + (hysteresis)
- When in level N, transition to level N - 1 when VSUPPLY falls below level N threshold

The amount of hysteresis is defined by the [BPE\\_VTHRESH\\_HYST](#) register. The hysteresis is only applied to the thresholds when supply voltage is increasing. The amount of hysteresis can be defined as larger than the distance between two levels.

Thresholds must be configured so that the level N threshold is greater than the sum of the level N - 1 threshold and the hysteresis. For example, if the level 2 threshold is set to 3.15V and hysteresis is set to 25mV, then the level 3 threshold must be set to 3.1875V or higher.

The current level that the BPE is in can be read-back using the [BPE\\_STATE](#) register. The [BPE\\_LOWEST](#) register contains the lowest BPE level that the controller has visited since the last time the [BPE\\_LOWEST](#) register was read.



### BPE Level Configuration Options

For a given BPE level, the following options are configurable to reduce the overall device current draw:

Gain Attenuation Function

Limiter Function

Each of these configuration options are individually configurable for each BPE level.

### BPE Gain Attenuation Function

The speaker gain attenuation block reduces the overall current draw by the device at low supply voltages by applying smooth digital gain changes to the signal path. The maximum attenuation that can be applied can be independently configured for each BPE level. The maximum attenuation that can be applied for each level is programmable from 0 to -31dB in 1dB steps and is configured using the [BPE\\_Lx\\_MAXATTN](#) bits.

When the  $V_{SUPPLY}$  voltage level falls below the programmed level, the brownout controller waits for a time equal to the programmed dwell time for the level before applying attenuation at the programmed attack rate. The brownout controller then enters the hold time phase when the  $V_{SUPPLY}$  voltage increases and causes the brownout controller to enter the next level. After the programmed hold time for a BPE level expires, the controller enters the release phase where the controller releases the attenuation at the programmed release rate. Additionally, each BPE level has independent programmable settings for dwell time ([BPE\\_Lx\\_DWELL](#)), hold time ([BPE\\_Lx\\_HOLD](#)), attack and release step size ([BPE\\_Lx\\_STEP](#)), attack rate ([BPE\\_Lx\\_GAIN\\_ATK](#)), and release rate ([BPE\\_Lx\\_GAIN\\_RLS](#)). While the attack and release rates are independently configurable for the gain attenuation and limiter block, the attack and release step size settings are common.

The [BPE\\_LOWEST\\_GAIN](#) register contains the lowest gain (highest attenuation) applied the brownout controller. The register is updated upon reading to show the current attenuation applied by the BPE.

### BPE Limiter Function

The BPE limiter function allows the device to reduce the overall current draw at low supply levels by quickly attenuating (15 $\mu$ s) input signals that exceed a programmed threshold. When the BPE limiter is enabled ([BPE\\_LIM\\_EN](#) = 1), the device ignores the Signal Distortion Limiter and Signal Level Limiter settings in the DHT. In this state, the limiter knee threshold is determined solely by the BPE limiter setting of the current BPE level. Each BPE level has an individually configured limiter threshold (set by [BPE\\_Ln\\_LIM](#)) that is programmable from 0dBFS and -15dBFS in 1dB steps.

Input signals that exceed the limiter knee threshold are attenuated, while input signals below the threshold are not. Each BPE level has an individually configured attack and release step size ([BPE\\_Lx\\_STEP](#)), attack rates ([BPE\\_Lx\\_LIM\\_ATK](#)), and release rates ([BPE\\_Lx\\_LIM\\_RLS](#)). While the attack and release rates are independently configurable for the gain attenuation and limiter block, the attack and release step size settings are common.

The [BPE\\_LOWEST\\_LIMIT](#) register contains the lowest limiter setting applied the brownout controller. The register is updated upon reading to show the current limiter setting applied by the BPE.

### Brownout Interrupts

The BPE can generate interrupts triggered by the following conditions:

- BPE controller enters level 0 ([BPE\\_L0](#) \*)
- BPE controller changes from one level to another ([BPE\\_LEVEL](#) \*)
- BPE controller is active ([BPE\\_ACTIVE\\_BGN](#) \*)
- BPE controller is no longer active ([BPE\\_ACTIVE\\_END](#) \*)

See the [Interrupts](#) section for more information.

## Measurement ADC

The device features a configurable 9-bit measurement ADC. The measurement ADC has three channels, one for die temperature measurement (measurement ADC thermal channel), one for PVDD supply voltage measurement (measurement ADC PVDD channel), and one for VBAT supply voltage measurement (measurement ADC VBAT channel). Enabled channels are measured sequentially and continuously. The programmable measurement ADC sample rate can be set independently for each channels. Each channel separately provides an optional programmable lowpass IIR filter.

### Measurement ADC Thermal Channel

When the device is clocked in the active state ( $EN = 1$ ), the measurement ADC thermal channel automatically activates. When active, it continuously measures and reports the device die temperature over the range from  $-29^{\circ}\text{C}$  to  $+150^{\circ}\text{C}$ .

The output of the thermal ADC channel can be readback through the [MEAS\\_ADC\\_THERM\\_DATA](#) bit field and is the input to both the thermal protection and thermal foldback blocks. By default ([MEAS\\_ADC\\_THERM\\_RD\\_MODE](#) = 0), the thermal readback value is automatically updated after each conversion is completed. Setting [MEAS\\_ADC\\_THERM\\_RD\\_MODE](#) to 1 places thermal readback into manual mode. In manual mode, the thermal readback result is updated manually when 1 is written to the [MEAS\\_ADC\\_THERM\\_UPD](#) bit field. The ADC thermal channel data readback in manual mode and the data streamed through the PCM interface are 9 bits. In automatic mode, since the 9-bit data readback is from two registers, the LSB register is not guaranteed to be synchronous with the MSB register and can result in higher noise.

The thermal ADC channel also provides an optional lowpass IIR filter with a programmable bandwidth that scales relative to the measurement ADC sample rate. The filter is enabled with the [MEAS\\_ADC\\_TEMP\\_FILT\\_EN](#) bit field, and the bandwidth is set with the [MEAS\\_ADC\\_TEMP\\_FILT\\_COEFF](#) bit field.

### Measurement ADC PVDD Channel

When the device is clocked and in the active state ( $EN = 1$ ), the measurement ADC PVDD channel can be enabled. The PVDD channel is manually enabled by setting the [MEAS\\_ADC\\_PVDD\\_EN](#) bit to 1 and must be manually enabled for the DHT to operate. When the channel is enabled, it continuously measures and reports the PVDD supply voltage level over the range of 2.5V to 20V.

The output of the measurement ADC PVDD channel can be read back through the [MEAS\\_ADC\\_PVDD\\_DATA](#) bit field and is routed to the DHT. By default ([MEAS\\_ADC\\_PVDD\\_RD\\_MODE](#) = 0), the PVDD readback value is automatically updated after each conversion is completed. Setting [MEAS\\_ADC\\_PVDD\\_RD\\_MODE](#) to 1 places PVDD readback into manual mode. In manual mode, the readback result is updated when 1 is written to the [MEAS\\_ADC\\_PVDD\\_RD\\_UPD](#) bit field. The ADC PVDD channel data readback in manual mode and the data streamed through the PCM interface are 9 bits. In automatic mode, since the 9-bit data readback is from two registers, the LSB register is not guaranteed to be synchronous with the MSB register and can result in higher noise.

The lowest PVDD measurement is readback through the [LOWEST\\_PVDD\\_DATA\\_MSB](#) and [LOWEST\\_PVDD\\_DATA\\_LSB](#) bit fields. These bit fields both automatically clear and are reset to the value of the current measurement result immediately after LSB readback is completed.

The PVDD channel also provides an optional lowpass IIR filter with a programmable bandwidth that scales relative to the measurement ADC sample rate. The filter is enabled with the [MEAS\\_ADC\\_PVDD\\_FILT\\_EN](#) bit and the bandwidth is set with the [MEAS\\_ADC\\_PVDD\\_FILT\\_COEFF](#) bit field.

### Measurement ADC VBAT Channel

When the device is clocked in the active state ( $EN = 1$ ), the measurement ADC VBAT channel can be enabled. The VBAT channel is manually enabled by setting the [MEAS\\_ADC\\_VBAT\\_EN](#) bit to 1 and must be manually enabled for the DHT to operate. When the channel is enabled, it continuously measures and reports the VBAT supply voltage level over the range of 2.5V to 5.5V.

The output of the measurement ADC VBAT channel can be read back through the [MEAS\\_ADC\\_VBAT\\_DATA](#) bit field. By default ([MEAS\\_ADC\\_VBAT\\_RD\\_MODE](#) = 0), the VBAT readback value is automatically updated after each conversion

is completed. Setting [MEAS\\_ADC\\_VBAT\\_RD\\_MODE](#) to 1 places VBAT readback into manual mode. In manual mode, the readback result is updated when 1 is written to the [MEAS\\_ADC\\_VBAT\\_RD\\_UPD](#) bit field. The ADC VBAT channel data readback in manual mode and the data streamed through the PCM interface are 9 bits. In automatic mode, since the 9-bit data readback is from two registers, the LSB register is not guaranteed to be synchronous with the MSB register and can result in higher noise.

The lowest measured VBAT measurement result is readback through the [LOWEST\\_VBAT\\_DATA\\_MSB](#) and [LOWEST\\_VBAT\\_DATA\\_LSB](#) bit fields. These bit fields both automatically clear and are reset to the value of the current measurement result immediately after LSB readback is completed.

The VBAT channel also provides an optional lowpass IIR filter with a programmable bandwidth that scales relative to the measurement ADC sample rate. The filter is enabled with the [MEAS\\_ADC\\_VBAT\\_FILT\\_EN](#) bit and the bandwidth is set with the [MEAS\\_ADC\\_VBAT\\_FILT\\_COEFF](#) bit field.

### Clock and Data Monitors

The device has input data and external clock monitors that detect host and system level faults. The data monitor detects persistent stuck and high amplitude input signals while the clock monitor detects external clock failures and invalid clock configurations. Upon fault detection, these monitors automatically place the device into software shutdown to stop glitches and unwanted signals at the amplifier output and speaker load.

#### Input Data Monitor

The device has an optional input data monitor that is enabled by setting [DMON\\_MAG\\_EN](#) to 1 for the data magnitude monitor or [DMON\\_STUCK\\_EN](#) to 1 (for the data stuck monitor). Once the data monitor is enabled, it actively monitors the selected input data (from DIN) to the speaker amplifier path anytime the device exits software shutdown ([EN](#) = 1) and the amplifier is enabled ([SPK\\_EN](#) = 1). When the tone generator is enabled, the data monitor is automatically disabled.

When active, the block monitors the selected input data for the enabled data error types (data magnitude, data stuck, or both). The [DMON\\_DURATION](#) bit field selects the duration that a data stuck or magnitude error must persist before a data error is detected. Once a data error is detected, the data monitor automatically places the device into software shutdown (sets [EN](#) to 0) and generates a data monitor error interrupt ([DMON\\_ERR\\_\\*](#)).

A data stuck error is detected if the input signal repeats a fixed value with a magnitude (positive or negative) that is beyond the data stuck threshold ([DMON\\_STUCK\\_THRES](#)) for longer than the data error duration (set by [DMON\\_DURATION](#)). If the input signal repeats a fixed value for any duration with a magnitude that is within the data stuck threshold limits (such as a zero or near zero code), no data stuck error is detected.

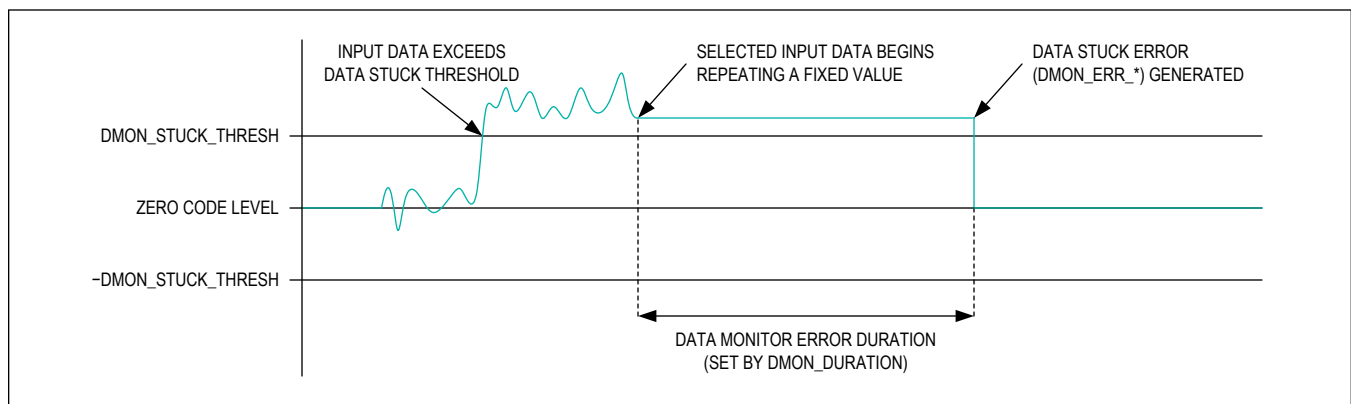

Figure 28. Data Monitor Error Generation due to Input Data Stuck Error Detection

A data magnitude error is detected if the input signal magnitude (positive or negative) is beyond the data magnitude threshold (set by [DMON\\_MAG\\_THRES](#)) for longer than the data error duration (set by [DMON\\_DURATION](#)).

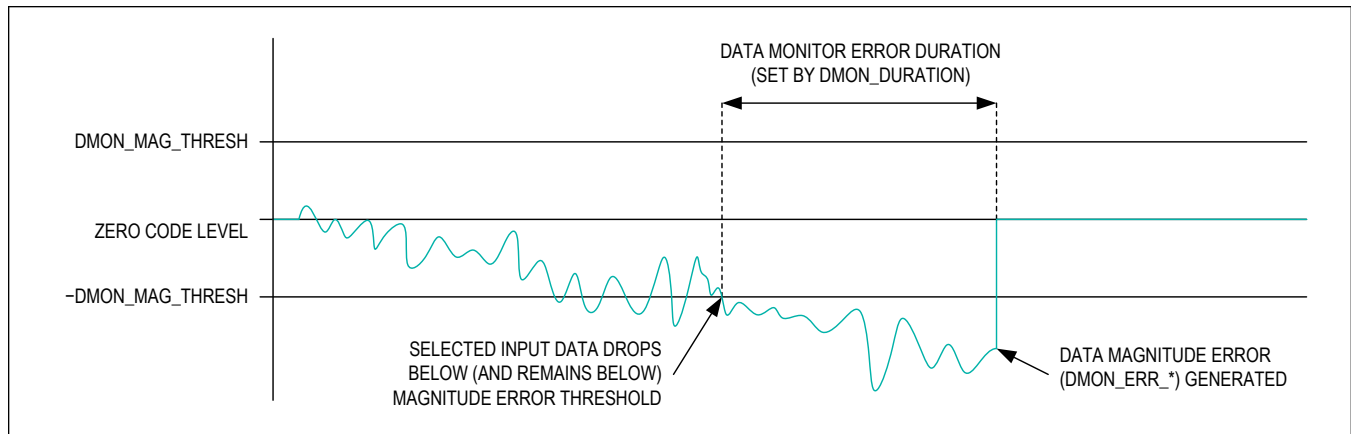

Figure 29. Monitor Error Generation due to Input Data Magnitude Error Detection

### Clock Monitor

The device provides an optional clock monitor that is enabled by setting [CMON\\_EN](#) to 1. Once enabled, it actively monitors the input BCLK and LRCLK anytime the device exits software shutdown ( $EN = 1$ ). When the tone generator is enabled, the clock monitor is automatically disabled. When active, the clock monitor detects clock activity, clock frequency, and frame timing (clock ratio). If faults are detected, the clock monitor automatically places the device into software shutdown and generates a clock error interrupt ([CLK\\_ERR\\_\\*](#)).

The clock monitor operates in automatic mode when [CMON\\_AUTORESTART\\_EN](#) = 1 and manual mode when [CMON\\_AUTORESTART\\_EN](#) = 0. In automatic mode, when a clock error places the device into software shutdown, the global enable bit ( $EN$ ) is not changed (remains 1) and the device automatically recovers from all clock errors. In automatic mode, both clock error ([CLK\\_ERR\\_\\*](#)) and clock recovery ([CLK\\_RECOVER\\_\\*](#)) interrupts are generated in pairs (a clock recovery interrupt is not possible until after a clock error has occurred).

In manual mode, when a clock error places the device into software shutdown, the global enable bit ( $EN$ ) is set to 0. Clock recovery ([CLK\\_RECOVER\\_\\*](#)) interrupts are never generated in manual mode, and the device remains in software shutdown until the host sets  $EN$  back to 1. Once the device is re-enabled ( $EN$  set to 1), the clock monitor is active and detects any new (or persisting) clock errors. If a clock error is detected, the device returns to software shutdown ( $EN = 0$ ), and a new clock error interrupt ([CLK\\_ERR\\_\\*](#)) is generated.

Clock errors are fault conditions, and audible glitches may occur on clock monitor based transitions into and out of software shutdown. When the clock monitor is enabled, no false clock error or clock recovery interrupts are generated when the host software transitions the device normally into and out of software shutdown.

### Clock Activity and Frequency Detection

When the clock monitor is enabled, the bit clock (BCLK) and frame clock (LRCLK) frequencies are monitored. The expected LRCLK frequency is equal to the PCM sample rate ([PCM\\_SR](#)). The expected BCLK frequency is based on the BCLK to LRCLK ratio ([PCM\\_BSEL](#)) relative to the PCM sample rate ([PCM\\_SR](#)).

The current frequency of each clock is measured relative to (and once per interval of) the programmed frame period (as set by [PCM\\_SR](#)). A clock frequency error is detected when the measured clock frequencies differ from programmed clock frequencies (faster or slower) by more than the frequency error threshold (45% typ). If either clock stops high or low, the frequency measurement result allows detection of the clock stop event.

The [CMON\\_ERRTOL](#) bit field sets the clock frequency error tolerance. The tolerance is the required number of consecutive frame clock periods ([PCM\\_SR](#)) with an incorrect clock frequency before a clock error is generated. If the error persists for the selected number of frame periods, a clock error interrupt ([CLK\\_ERR\\_\\*](#)) is generated and the device is placed into software shutdown.

In automatic mode, the [CMON\\_ERRTOL](#) bit field also sets the number of consecutive frame clock periods without clock frequency errors (LRCLK or BCLK) that are required for automatic restart to occur. Once the selected number of

consecutive error-free frames are detected, a clock recovery interrupt ([CLK\\_RECOVER\\_\\*](#)) is generated and the device automatically exits software shutdown.

In manual mode, no clock recovery interrupts are generated. The clock monitor remains disabled and the device remains in software shutdown until the host software sets [EN](#) back to 1.

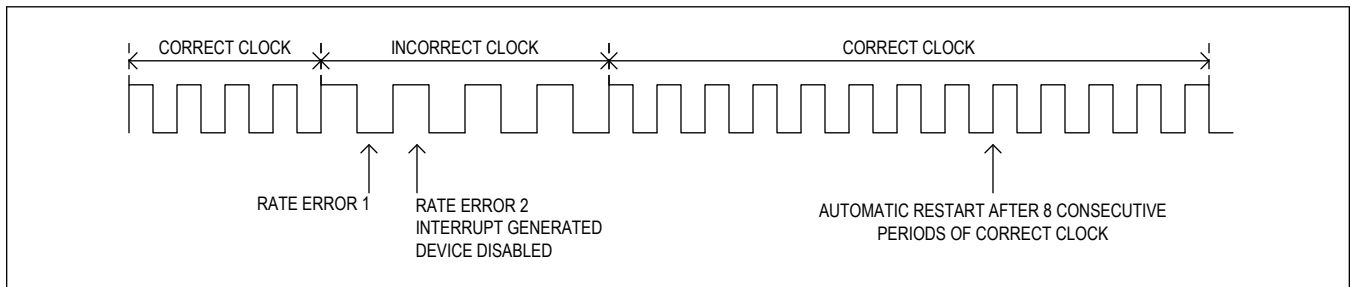

Figure 30. Clock Monitor LRCLK Rate Error Example With [CMON\\_ERRTOL](#) = 0x1

### Clock Frame Error Detection

When the clock monitor is enabled, the bit clock (BCLK) to frame clock (LRCLK) ratio is monitored. The clock monitor counts the number of BCLK periods per frame (LRCLK period) and then compares the count to the configured clock ratio ([PCM\\_BSEL](#)). In addition, in I<sup>2</sup>S and left-justified modes the clock monitor verifies the LRCLK duty cycle by checking that the number of BCLK periods per channel is equal. In TDM mode, data transport is synchronized to the active frame clock (LRCLK) edge, so no duty cycle restrictions are enforced.

A frame error is detected in each frame where the monitored clock ratio (and duty cycle in I<sup>2</sup>S and left-justified modes) differs from the configured settings. The [CMON\\_BSELTOL](#) bit field sets the number of consecutive frames with frame errors that are required before a clock error interrupt is generated ([CLK\\_ERR\\_\\*](#)) and the device is placed into software shutdown.

In automatic mode, the [CMON\\_BSELTOL](#) bit field also sets the number of consecutive frames without frame errors that are required for automatic restart to occur. Once the selected number of consecutive error-free frames are detected, a clock recover interrupt ([CLK\\_RECOVER\\_\\*](#)) is generated and the device automatically exits software shutdown.

In manual mode, no clock recovery interrupts are generated; the clock monitor remains disabled and the device remains in software shutdown until the host software sets [EN](#) back to 1.

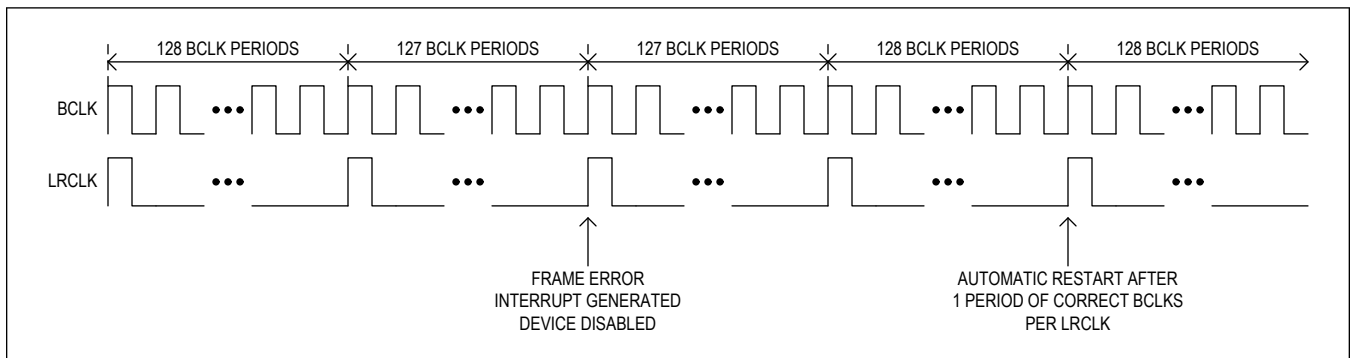

Figure 31. Clock Monitor Framing Error Example In TDM Mode With [PCM\\_BSEL](#) = 0x6 and [CMON\\_BSELTOL](#) = 0x0

### Speaker Monitor

The speaker monitor is a circuit that is designed to protect the speaker against amplifier signals that could damage it. The speaker monitor is enabled by default and can be disabled by setting the [SPKMON\\_EN](#) bit to zero. The circuit monitors the amplifier's PWM signal and shuts down the amplifier output when the signal goes above a programmed speaker

monitor threshold (set by [SPKMON\\_THRESH](#)) for a programmed amount of time (set by [SPKMON\\_DURATION](#)). Additionally, the device also generates an [INT\\_SPKMON\\_ERR](#) interrupt.

The speaker monitor circuit uses PWM signals of the amplifier, and in the case of DC signals, the amplifier accurately detects signals above the threshold. However, for a sine wave with a DC offset, the average DC detected by the circuit is lower because of the zeroes presented from the sine signal. In this case, the speaker monitor threshold (set by [SPKMON\\_THRESH](#)) and/or the speaker monitor duration (set by [SPKMON\\_DURATION](#)) can be adjusted to protect the speaker against the DC present in the signal.

## Thermal Protection

When the device is active, the measurement ADC thermal channel is automatically enabled and monitors die temperature to ensure that it does not exceed the configured thermal thresholds. Interrupt registers are provided so that the device can notify the host when the die temperature crosses either the thermal warning or thermal-shutdown threshold, or when thermal foldback starts and stops.

### Thermal Warning and Thermal Shutdown Configuration

The device features two thermal-warning thresholds. The thermal-warning thresholds are configured by [THERMWARN1\\_THRESH\[6:0\]](#) and [THERMWARN2\\_THRESH\[6:0\]](#) bit fields and the thermal shutdown threshold is configured by the [THERMSHDN\\_THRESH\[5:0\]](#) bit field. The thermal-warning2 threshold should always be set to a temperature higher than or equal to thermal-warning1 temperature. Additionally, the thermal-warning2 threshold temperature should never be configured higher than the thermal shutdown threshold temperature minus hysteresis. When the die temperature is decreasing, hysteresis is applied to thermal-shutdown, thermal-warning1, and thermal-warning2 thresholds. The temperature hysteresis is configured with [THERM\\_HYST](#) bit field.

### Thermal Shutdown Recovery Configuration

The device thermal-shutdown recovery behavior is determined by the state of [THERM\\_AUTORESTART\\_EN](#) bit. When the [THERM\\_AUTORESTART\\_EN](#) bit is set to 0, the thermal-shutdown recovery is in manual mode. In manual mode, when the die temperature exceeds the thermal shutdown threshold, an interrupt is generated and the amplifier output is automatically disabled. Once the die temperature drops below both of the thermal-shutdown threshold minus the hysteresis and the thermal-warning2 threshold minus the hysteresis, the appropriate interrupts are generated to notify the host. In addition, once the die temperature drops below the thermal-warning2 threshold minus the hysteresis, the device is placed into software shutdown ([EN](#) is set to 0) and remains in that state until the host manually re-enables the device. When the [THERM\\_AUTORESTART\\_EN](#) bit is set to 1, the thermal-shutdown recovery is in automatic mode. In automatic mode, when the die temperature exceeds the thermal-shutdown threshold, an interrupt is generated and the amplifier is automatically disabled. Once the die temperature drops below the thermal shutdown threshold minus the hysteresis, an interrupt is generated but the amplifier remains disabled. When the temperature drops below the thermal-warning2 threshold minus the hysteresis, another interrupt is generated and (unlike manual mode) the amplifier is then automatically re-enabled.

### Thermal Foldback

The device features thermal foldback to allow for a smoother audio response to high temperature events. Thermal foldback is enabled by setting the [THERMFB\\_EN](#) bit to 1. The device provides two thermal-warning thresholds that are configured by the [THERMWARN1\\_THRESH\[6:0\]](#) and [THERMWARN2\\_THRESH\[6:0\]](#) bit fields. They should be set such that thermal-warning2 threshold temperature is higher than or equal to thermal-warning1 threshold temperature. Additionally, the thermal-warning2 threshold temperature should never be configured higher than the thermal shutdown threshold temperature minus hysteresis.

Once enabled, thermal foldback begins when the die temperature exceeds the configured thermal-warning1 threshold, interrupts are generated ([THERMFB\\_BGN \\*](#) and [THERMWARN1\\_BGN \\*](#)), and attenuation is applied to the speaker amplifier path. The slope of the thermal foldback attenuation is programmed with the [THERMFB\\_SLOPE1](#) bit field.

If the die temperature continues to increase and exceeds the configured thermal-warning2 threshold, an interrupt ([THERMWARN2\\_BGN \\*](#)) is generated and attenuation continues to be applied to the speaker amplifier path. The slope of the attenuation applied to the speaker amplifier path is programmed with the [THERMFB\\_SLOPE2](#) bit field. As the die



temperature increases, the level of attenuation also increases proportionally up to a maximum level of -12dB (unless the thermal shutdown threshold is exceeded first). When thermal foldback is active, the attack time for a gain change can be a maximum of two samples. Additionally, there is a sample delay in the signal path attenuation due to the group delay of the amplifier.

When the die temperature starts to decrease and drops below the thermal-warning2 threshold minus the programmed hysteresis level and remains there for longer than the programmed hold time (set with the [THERMFB\\_HOLD](#) bit field), the attenuation starts to release and an interrupt ([THERMWARN2\\_END](#) \*) is generated. If the die temperature continues to reduce and drops below the thermal-warning1 threshold temperature minus the programmed hysteresis level, thermal foldback ends and interrupts ([THERMFB\\_END](#) \* and [THERMWARN1\\_END](#) \*) are generated. The attenuation release rate (for decreasing temperature) is programmable and configured with the [THERMFB\\_RLS](#) bit field.

### Tone Generator

The device includes a tone generator which is enabled using the [TONE\\_EN](#) bit field and replaces the PCM interface as the input source to the speaker playback path. When the tone generator is enabled, both it and the speaker playback path operate without the need for any external clocks.

The tone generator output is configured to generate sine wave or DC tones (using the [TONE\\_CONFIG](#) bit field).

The tone generator can create sine waves with either a 1kHz fixed frequency or a variable sample rate dependent frequency. When a sample rate based sinewave output is selected, the tone generator output frequency is set by the playback sample rate setting ([PCM\\_SR](#)) divided by the selected ratio (as set by [TONE\\_CONFIG](#)). For the playback sample rate of 44.1kHz and its multiples, the tone generator output frequency can vary by up to 9%. The tone generator supports all available sample rate settings ([PCM\\_SR](#)). The amplitude of the output sine wave relative to full-scale is selected with the [TONE\\_AMPLITUDE](#) bit field.

The tone generator can output either a fixed or a programmable DC output level (as set by [TONE\\_CONFIG](#)). Fixed DC output levels of zero code, positive half-scale, and negative half-scale are provided for quick configuration. If the programmable DC output level is selected ([TONE\\_CONFIG](#)), the DC level is configured as a signed two's complement value with the [TONE\\_DC](#) bit field.

### Pink Noise Generator

The device includes a pink noise generator, which is enabled using the [PINK\\_NOISE\\_EN](#) bit field and replaces the PCM interface as the input source to the speaker playback path. The pink noise generator and the tone generator cannot be enabled at the same time. When the pink noise generator is enabled, both it and the speaker playback path operate without the need for any external clocks. The output level of the generator is fixed, so the amplifier gain and speaker volume must be used to adjust the level.

### Interchip Communication

The device features an interchip communication (ICC) interface that uses a shared data bus to facilitate synchronized speaker amplifier path attenuation adjustments across groups of devices. Depending on the configuration, the ICC interface can synchronize brownout-prevention engine (BPE), DHT, and thermal foldback. Each device receives the data of the other grouped devices and reacts accordingly.

### ICC Operation and Data Format

The bidirectional ICC bus is used to synchronize the responses of grouped devices. To create the ICC bus, the ICC interface pins of each device are externally connected together (whether or not the devices are in the same group). The ICC bus operates with the same clock sources and data format configuration as the PCM interface data input (DIN), and can support a maximum of 16 channels. For a given valid PCM interface configuration, the number of available ICC data channels per frame is calculated as follows (based on the [PCM\\_CHANSZ](#), [PCM\\_BSEL](#), and [PCM\\_FORMAT](#) settings):

$$\text{Number of Available Data Input Channels} = \text{BCLK to LRCLK Ratio} / \text{Channel Length}$$

The ICC interface is disabled when both the ICC data transmit output ([ICC\\_TX\\_EN](#)) and the ICC data link ([ICC\\_LINK\\_EN](#)) are disabled. To enable the ICC interface, both [ICC\\_TX\\_EN](#) and [ICC\\_LINK\\_EN](#) must be set to

1. It is invalid to set these controls to different values, and both must always be set to the same state (either enabled or disabled). Once the ICC link and data transmit are enabled, the ICC data output channel is assigned with the [ICC\\_TX\\_DEST](#) bit field. The ICC pin is Hi-Z during all other data channels, and can be configured (with the [ICC\\_RX\\_CHn\\_EN](#) bits) to accept data from the output data channels of grouped devices.

The transmitted ICC data is always the same size as the configured PCM data input word size (set by [PCM\\_CHANSZ](#)). When a 16-bit data word is selected, the ICC data word is not long enough to synchronize BPE, DHT, and thermal foldback. In this case, the [ICC\\_DATA\\_SEL](#) bit is used to choose whether the DHT function or thermal foldback function is synchronized in addition to BPE state. When a 24-bit or 32-bit data word size is selected, ICC can synchronize BPE, DHT, and thermal foldback across a given group. In these cases, the [ICC\\_DATA\\_SEL](#) bit has no effect. Active ICC data channels always contain ICC data words followed by zero padding bit up to the ICC data channel length (which is equal to PCM input data channel length). If BPE, DHT, or thermal foldback is disabled for any given group, then the transmitted ICC data for the disabled function(s) is always zero code.

### Multiamplifier Grouping

The ICC interface allows multiple devices to be grouped so that BPE, DHT, and thermal foldback behavior can be synchronized. The receive channel enables ([ICC\\_RX\\_CHn\\_EN](#)) are used to define groups. A given device monitors all selected channels (when [ICC\\_RX\\_CHn\\_EN](#) = 1, and n denotes the channel number) on the ICC data bus. The configured set of receive channels must also include the assigned transmit channel (as set by [ICC\\_TX\\_DEST](#)) for any given device. Each device in a given group must have identical settings for all ICC receive channel enables ([ICC\\_RX\\_CHn\\_EN](#)). Furthermore, all devices in the same group must have identical DHT, thermal protection, and thermal foldback settings to achieve a synchronized response across the group. The behavior of a group as a whole is undefined if any given device in a group has different settings.

The ICC bus can support a maximum of 16 data channels. The minimum size of a group is two devices, and as a result the maximum number of concurrent groups on a single ICC bus is eight. A group can contain as many as 16 devices, but then only a single group is possible on a single ICC bus.

### ICC Multi-Group Example

Consider a system design that includes four devices that require DHT synchronization, and that two distinct groups of two devices each (with different DHT settings) must share single ICC bus. The PCM interface (and thus ICC bus) is configured in TDM mode 1 with four 16-bit data channels available. One possible configuration (among many) is to assign devices 1 and 3 to the first group (denoted group A), and to assign devices 2 and 4 to the second group (denoted group B).

To configure group A, both devices 1 and 3 are set to monitor channels 0 and 2 by programming [ICC\\_RX\\_CH0\\_EN](#) = 1 and [ICC\\_RX\\_CH2\\_EN](#) = 1 on both devices (all other ICC receive bit fields are 0). Device 1 transmits on channel 0 ([ICC\\_TX\\_DEST](#) = 0x0) and device 3 transmits on channel 2 ([ICC\\_TX\\_DEST](#) = 0x2).

To configure group B, both devices 2 and 4 are set to monitor channels 1 and 3 by programming [ICC\\_RX\\_CH1\\_EN](#) = 1 and [ICC\\_RX\\_CH3\\_EN](#) = 1 on both devices (all other ICC receive bit fields are 0). Device 2 transmits on channel 1 ([ICC\\_TX\\_DEST](#) = 0x1) and device 4 transmits on channel 3 ([ICC\\_TX\\_DEST](#) = 0x3).

Since the ICC channel length and data word size is limited to 16 bits, the [ICC\\_DATA\\_SEL](#) bit field in all four devices must be set to 0 to select DHT target attenuation synchronization. Finally, on all four devices set [ICC\\_LINK\\_EN](#) = 1 and [ICC\\_TX\\_EN](#) = 1 to enable the ICC interfaces.



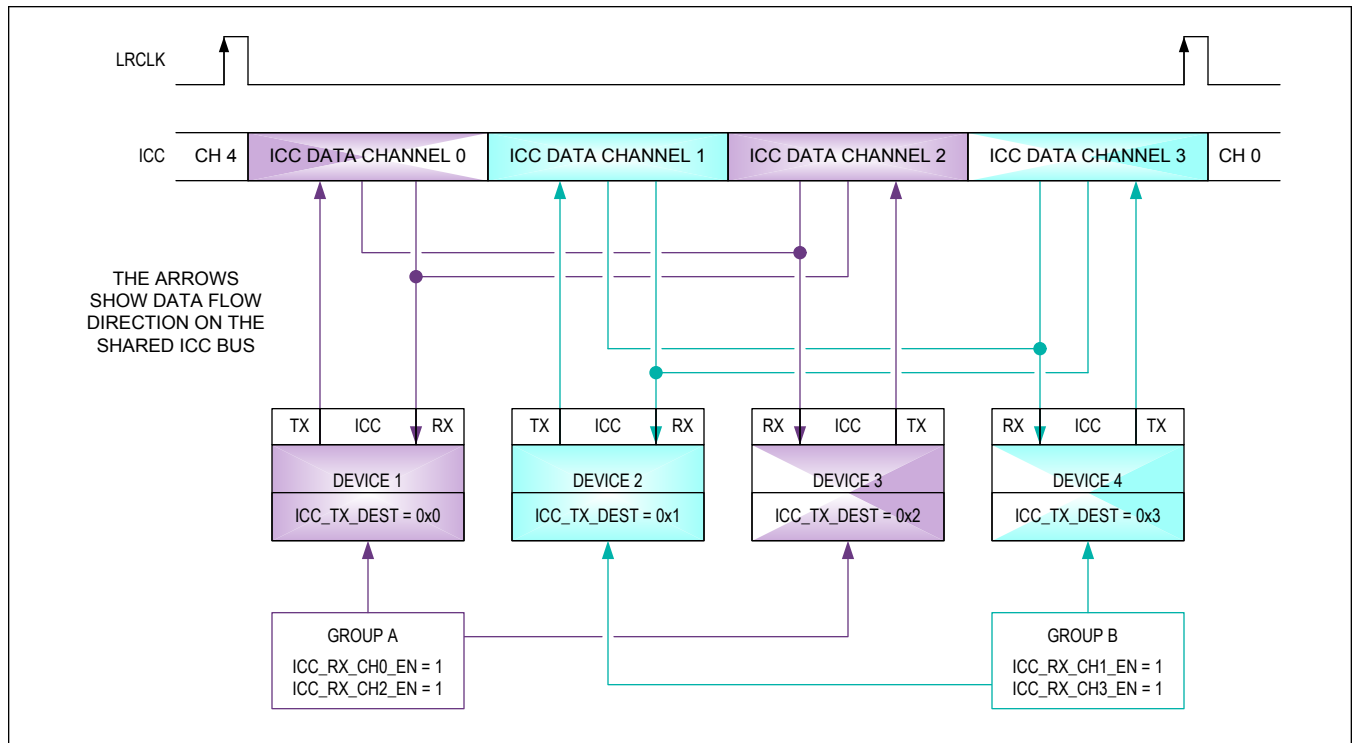

Figure 32. ICC Multi-Group Example with 2 Groups and 4 Total Devices

### I<sup>2</sup>C Serial Interface

The I<sup>2</sup>C serial control interface is activated when the device detects a valid I<sup>2</sup>C start condition at the I2C1 and I2C2 pins. The I2C1 and I2C2 pins can each act as either SCL or SDA respectively, and the start condition configures the device address and state of each pin. After the first I<sup>2</sup>C transaction, the I<sup>2</sup>C interface configuration should remain fixed.

### Slave Address

The slave address is defined as the seven most significant bits (MSBs) followed by the read/write bit. The seven most significant bits are programmable through the ADDR connection, and the required I2C1 and I2C2 connections for each address are shown in Table 10. The device does not communicate if ADDR is floating. Setting the read/write bit to 1 configures the device for read mode. Setting the read/write bit to 0 configures the device for write mode. The address is the first byte of information sent to the IC after the START condition.

Table 10. I<sup>2</sup>C Slave Address

I2C1	I2C2	ADDR CONNECTION	I <sup>2</sup> C SLAVE ADDRESS (BINARY)	I <sup>2</sup> C WRITE ADDRESS (BINARY)	I <sup>2</sup> C READ ADDRESS (BINARY)
SDA	SCL	Connected to DVDDIO	0111000x	01110000	01110001
SDA	SCL	Connected to GND	0111001x	01110010	01110011
SDA	SCL	Connected to SDA	0111010x	01110100	01110101
SDA	SCL	Connected to SCL	0111011x	01110110	01110111
SCL	SDA	Connected to DVDDIO	0111100x	01111000	01111001
SCL	SDA	Connected to GND	0111101x	01111010	01111011
SCL	SDA	Connected to SDA	0111110x	01111100	01111101
SCL	SDA	Connected to SCL	0111111x	01111110	01111111

The IC features an I<sup>2</sup>C/SMBus™-compatible, 2-wire serial interface consisting of a serial data line (SDA) and a serial clock line (SCL). SDA and SCL facilitate communication between the IC and the master at clock rates up to 1MHz. [Figure 33](#) shows the 2-wire interface timing diagram. The master generates SCL and initiates data transfer on the bus. The master device writes data to the IC by transmitting the proper slave address followed by two register address bytes (most significant byte first) and then the data word. Each transmit sequence is framed by a START (S) or REPEATED START (Sr) condition and a STOP (P) condition. Each word transmitted to the IC is 8 bits long and is followed by an acknowledge clock pulse. A master reading data from the IC transmits the proper slave address followed by a series of nine SCL pulses. The IC transmits data on SDA in sync with the master-generated SCL pulses. The master acknowledges receipt of each byte of data. Each read sequence is framed by a START (S) or REPEATED START (Sr) condition, a not acknowledge, and a STOP (P) condition. SDA operates as both an input and an open-drain output. A pullup resistor, typically greater than 500Ω, is required on SDA. SCL operates only as an input. A pullup resistor, typically greater than 500Ω, is required on SCL if there are multiple masters on the bus, or if the single master has an open-drain SCL output. Series resistors in line with SDA and SCL are optional. Series resistors protect the digital inputs of the IC from high voltage spikes on the bus lines, and minimize crosstalk and undershoot of the bus signals.

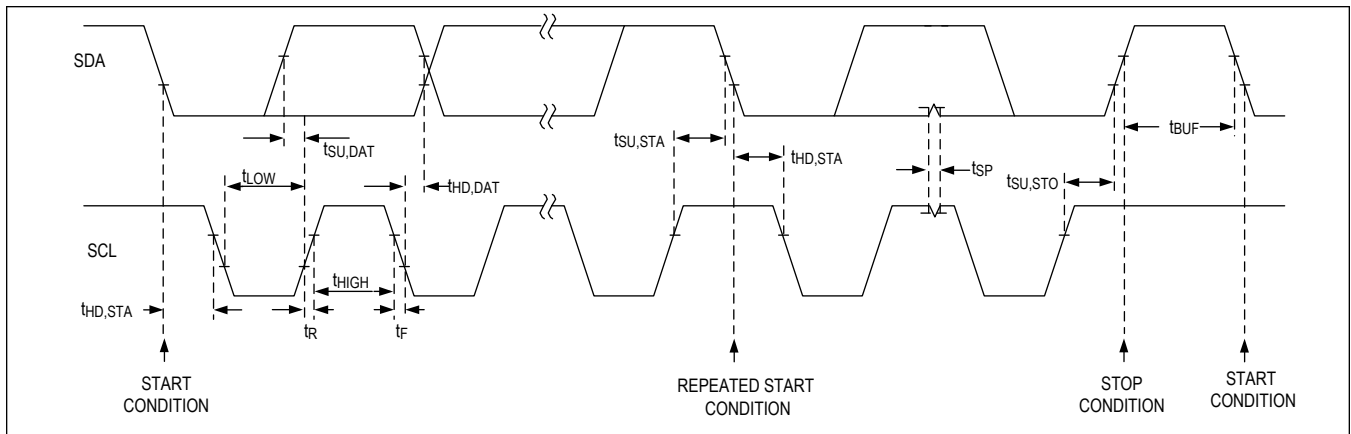

Figure 33. I<sup>2</sup>C Interface Timing Diagram

### Bit Transfer

One data bit is transferred during each SCL cycle. The data on SDA must remain stable during the high period of the SCL pulse. Changes in SDA while SCL is high are control signals (see the [START and STOP Conditions](#) section).

### START and STOP Conditions

SDA and SCL idle high when the bus is not in use. A master initiates communication by issuing a START condition. A START condition is a high-to-low transition on SDA with SCL high. A STOP condition is a low-to-high transition on SDA while SCL is high. A START condition from the master signals the beginning of a transmission to the IC. The master terminates transmission and frees the bus by issuing a STOP condition. The bus remains active if a REPEATED START condition is generated instead of a STOP condition.

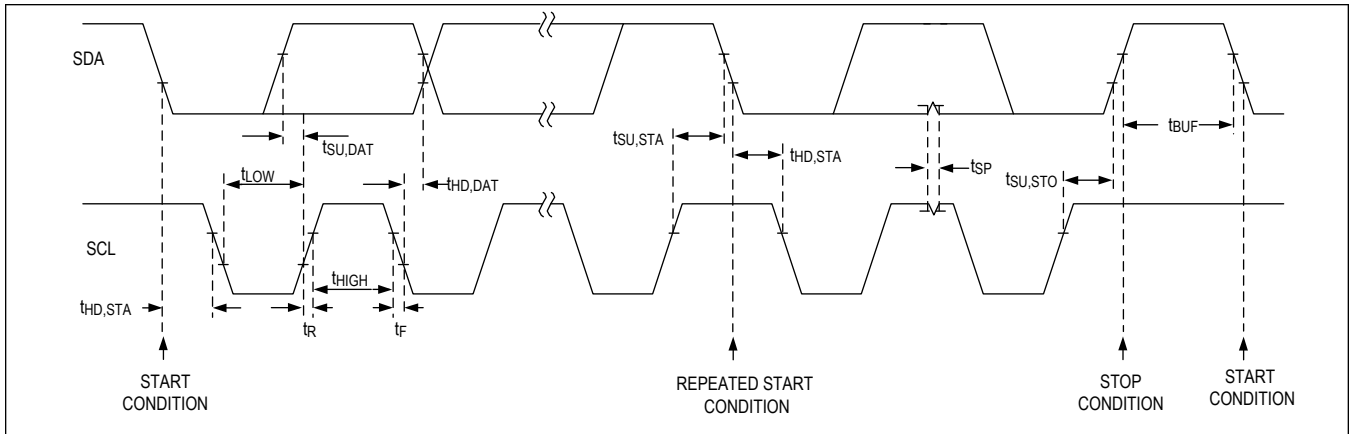

Figure 34. I<sup>2</sup>C START, STOP, and REPEATED START Conditions

**Early STOP Conditions**

The IC recognizes a STOP condition at any point during data transmission except if the STOP condition occurs in the same high pulse as a START condition. For proper operation, do not send a STOP condition during the same SCL high pulse as the START condition.

**Acknowledge**

The acknowledge bit (ACK) is a clocked 9th bit that the IC uses to handshake receipt each byte of data when in write mode. The IC pulls down SDA during the entire master-generated 9th clock pulse if the previous byte is successfully received. Monitoring ACK allows for detection of unsuccessful data transfers. An unsuccessful data transfer occurs if a receiving device is busy or if a system fault has occurred. In the event of an unsuccessful data transfer, the bus master retries communication. The master pulls down SDA during the 9th clock cycle to acknowledge receipt of data when the IC is in read mode. An acknowledge is sent by the master after each read byte to allow data transfer to continue. A not-acknowledge is sent when the master reads the final byte of data from the IC, followed by a STOP condition.

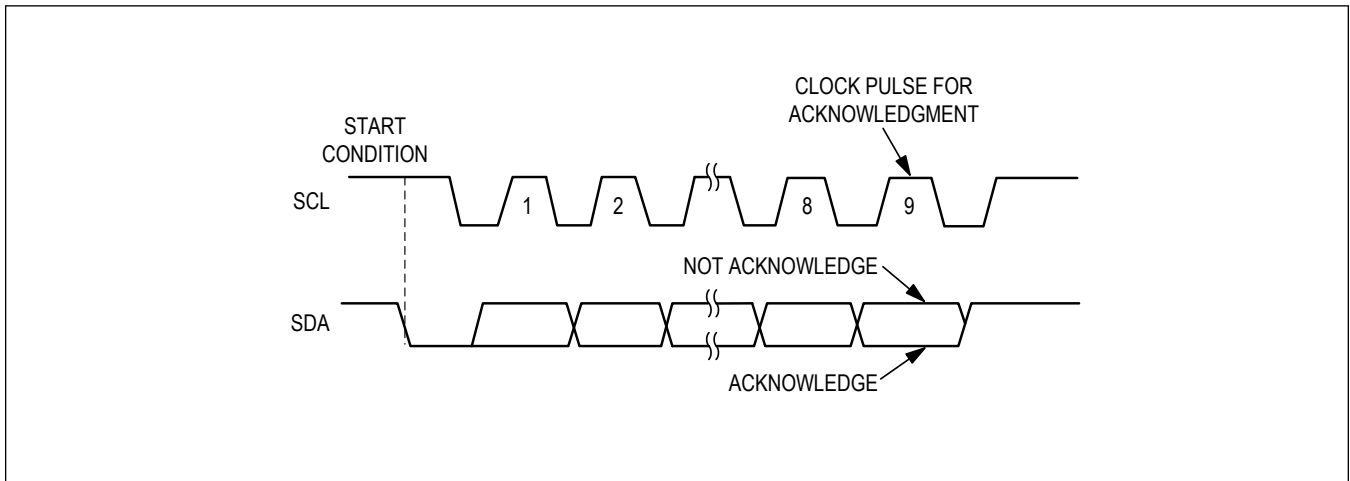

Figure 35. I<sup>2</sup>C Acknowledge

**Write Data Format**

A write to the IC includes transmission of a START condition, the slave address with the R/W bit set to 0, two bytes of data to configure the internal register address pointer, one or more bytes of data, and a STOP condition.

The slave address with the R/W bit set to 0 indicates that the master intends to write data to the IC. The IC acknowledges receipt of the address byte during the master-generated 9th SCL pulse.

The second and third bytes transmitted from the master configure the ICs internal register address pointer. The pointer tells the IC where to write the next byte of data. An acknowledge pulse is sent by the IC upon receipt of the address pointer data.

The third byte sent to the IC contains the data that is written to the chosen register. An acknowledge pulse from the IC signals receipt of the data byte. The address pointer auto-increments to the next register address after each received data byte. This auto-increment feature allows the master to write to sequential registers within one continuous frame. The master signals the end of transmission by issuing a STOP condition.

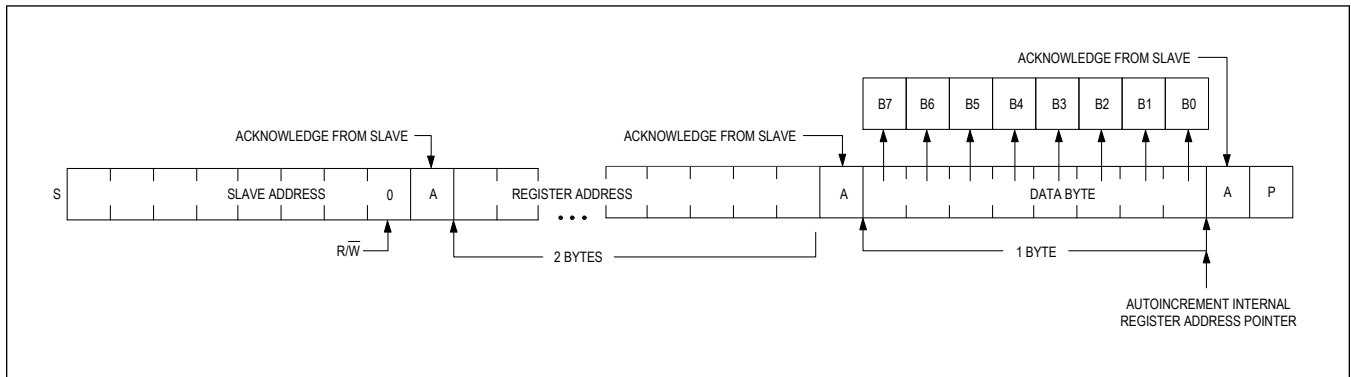

Figure 36. I<sup>2</sup>C Writing One Byte of Data to the Slave

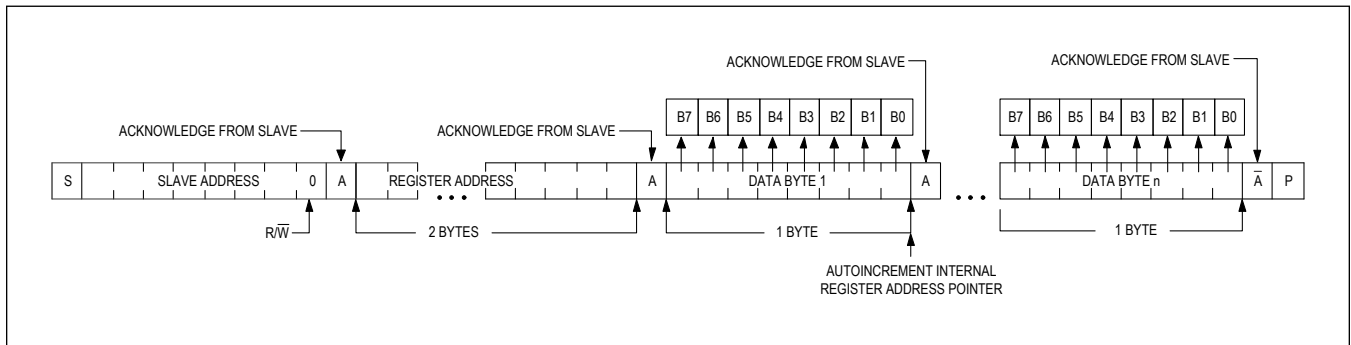

Figure 37. I<sup>2</sup>C Writing n-Bytes of Data to the Slave

**Read Data Format**

Initiate a read operation by sending the slave address with the R/W bit set to 1. The IC acknowledges receipt of its slave address by pulling SDA low during the 9th SCL clock pulse. A START command followed by a read command resets the address pointer to register 0x2000.

The first byte transmitted from the IC is the content of register 0x00. Transmitted data is valid on the rising edge of SCL. The address pointer auto-increments after each read data byte. This auto-increment feature allows all registers to be read sequentially within one continuous frame. A STOP condition can be issued after any number of read data bytes. If a STOP condition is issued followed by another read operation, the first data byte to be read is from register 0x00.

The address pointer can be preset to a specific register before a read command is issued. The master presets the address pointer by first sending the ICs slave address with the R/W bit set to 0 followed by the two byte register address. A REPEATED START condition is then sent followed by the slave address with the R/W bit set to 1. The IC then transmits the contents of the specified register. The address pointer auto-increments after transmitting the first byte.

The master acknowledges receipt of each read byte during the acknowledge clock pulse. The master must acknowledge

all correctly received bytes except the last byte. The final byte must be followed by a not acknowledge from the master and then a STOP condition.

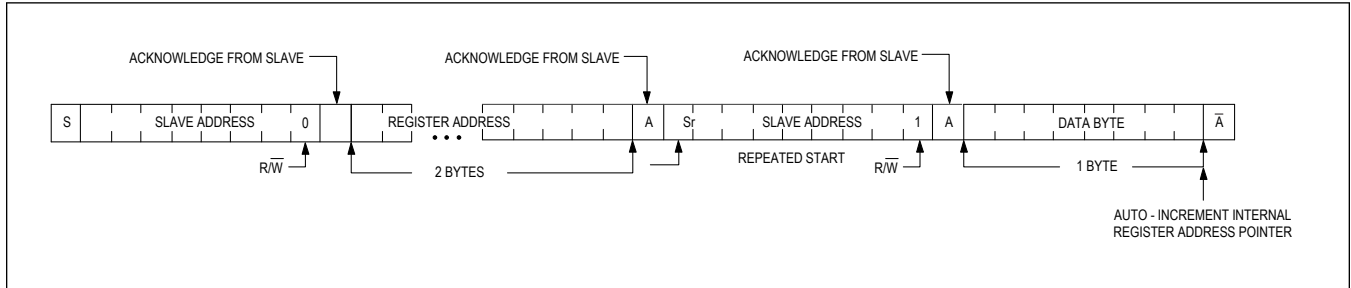

Figure 38. I<sup>2</sup>C Reading One Byte of Data from the Slave

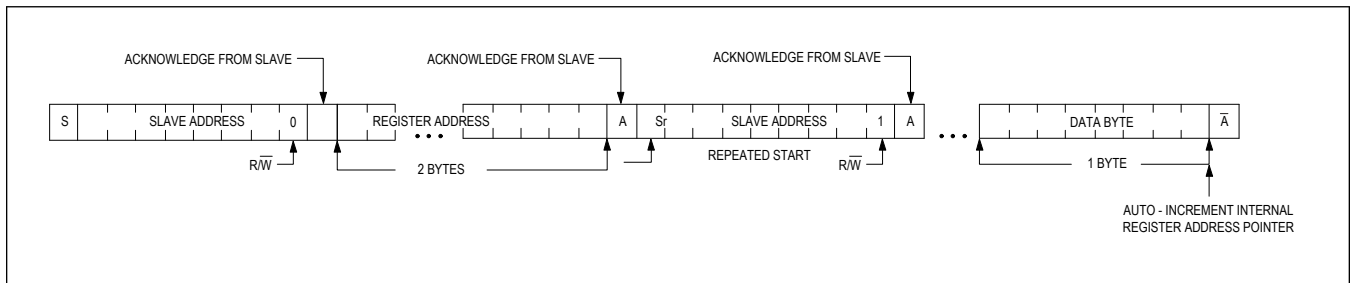

Figure 39. I<sup>2</sup>C Reading n-Bytes of Data from the Slave

## I<sup>2</sup>C Register Map

### Control Bit Field Types and Write Access Restrictions

The device control bit fields fall into one of three basic types: read, write, or read and write. There are no read restrictions, and any read enabled bit field can be read back anytime the I<sup>2</sup>C control interface is active. However, there are write restrictions, and every write enabled bit field falls into one of two write access subtypes.

The first write access subtype is dynamic. Dynamic bit fields effectively have no write access restrictions, and can be safely changed (written) in any device state where the I<sup>2</sup>C control interface is active. The second bit field access subtype is restricted. Restricted bit fields should only be changed (written) when the related functional block (as shown in [Table 11](#)) is powered down.

If the write access is restricted to the global enable (restrictions EN and ENL), then the restricted bit field should only be changed (written) when the device is in software-shutdown. As a form of system protection, write access to some critical global enable restricted bit fields (ENL) is locked out by the hardware when the device is not in the software-shutdown state. Attempting to change (write to) these locked restricted bit fields when the device is not in the software-shutdown state has no effect (read access is still allowed).

The bit field type and write access subtype is provided for every bit field in the detailed register description tables. For all bit fields with the restricted subtype, the dependency is also denoted in the "RES" column.

[Table 11](#) provides a detailed description of all device register types, access subtypes, and restriction dependencies that are used by this device. The write access restrictions describe the specific device condition(s) that should be met (and the corresponding bit field settings) before the system attempts to change (write to) bit fields with that restriction type.

**Table 11. Control Bit Types and Write Access Restrictions**

BIT FIELD TYPE	WRITE ACCESS	WRITE ACCESS RESTRICTIONS		"RES" SYMBOL
		DESCRIPTION	CONDITION	

**Table 11. Control Bit Types and Write Access Restrictions (continued)**

Read	Read Only	—	—	—
Write or Read/ Write	Dynamic	—	—	—
	Restricted	Device in Software Shutdown	EN = 0	<b>EN</b>
		Write Access Locked Out by Hardware Unless the Device in Software Shutdown	EN = 0	<b>ENL</b>
		Speaker Amplifier Output and Feedback Disabled	SPK_EN = 0 and SPK_FB_EN = 0	<b>SPK</b>
		Voltage and Current Sense ADCs Disabled	IVADC_V_EN = 0 and IVADC_I_EN = 0	<b>IVS</b>
		Thermal Foldback Disabled	THERMFB_EN = 0	<b>TFB</b>
		Noise Gate Disabled	NOISEGATE_EN = 0	<b>NG</b>
		Dynamic-Headroom Tracking Disabled	DHT_EN = 0	<b>DHT</b>
		Brownout-Prevention Engine Disabled	BPE_EN = 0	<b>BPE</b>
		PCM Interface Data Input and Output Disabled	PCM_RX_EN = 0 and PCM_TX_EN = 0	<b>PCM</b>
		PCM Data Output Disabled	PCM_TX_EN = 0	<b>TXEN</b>
		IRQ Bus Output Disabled	IRQ_EN = 0	<b>IRQ</b>
	Interchip Communication (ICC) Interface Disabled	ICC_LINK_EN = 0 and ICC_TX_EN = 0	<b>ICC</b>	

## Register Map

## Register Map

ADDRESS	NAME	MSB							LSB
<b>Reset</b>									
0x2000	<a href="#">Software Reset[7:0]</a>	-	-	-	-	-	-	-	RST
<b>Interrupts</b>									
0x2001	<a href="#">Interrupt Raw 1[7:0]</a>	THERM_SHDN_BGN_RAW	THERM_SHDN_END_RAW	THERM_WARN1_BGN_RAW	THERM_WARN1_END_RAW	THERMF_B_BGN_RAW	THERMF_B_END_RAW	OTP_FAIL_RAW	SPK_OVC_RAW
0x2002	<a href="#">Interrupt Raw 2[7:0]</a>	THERM_WARN2_BGN_RAW	THERM_WARN2_END_RAW	INT_SPK_MON_ERR_RAW	INT_CLK_ERR_RAW	-	CLK_RECOVER_RAW	CLK_ERR_RAW	DMON_ERR_RAW
0x2003	<a href="#">Interrupt Raw 3[7:0]</a>	-	-	PWRUP_DONE_RAW	PWRDN_DONE_RAW	PVDD_UVLO_SHDN_RAW	VBAT_UVLO_SHDN_RAW	DHT_ACTIVE_BGN_RAW	DHT_ACTIVE_END_RAW
0x2004	<a href="#">Interrupt Raw 4[7:0]</a>	-	-	-	-	BPE_LO_RAW	BPE_LEVEL_RAW	BPE_ACTIVE_BGN_RAW	BPE_ACTIVE_END_RAW
0x2006	<a href="#">Interrupt State 1[7:0]</a>	THERM_SHDN_BGN_STATE	THERM_SHDN_END_STATE	THERM_WARN1_BGN_STATE	THERM_WARN1_END_STATE	THERMF_B_BGN_STATE	THERMF_B_END_STATE	OTP_FAIL_STATE	SPK_OVC_STATE
0x2007	<a href="#">Interrupt State 2[7:0]</a>	THERM_WARN2_BGN_STATE	THERM_WARN2_END_STATE	INT_SPK_MON_ERR_STATE	INT_CLK_ERR_STATE	-	CLK_RECOVER_STATE	CLK_ERR_STATE	DMON_ERR_STATE
0x2008	<a href="#">Interrupt State 3[7:0]</a>	-	-	PWRUP_DONE_STATE	PWRDN_DONE_STATE	PVDD_UVLO_SHDN_STATE	VBAT_UVLO_SHDN_STATE	DHT_ACTIVE_BGN_STATE	DHT_ACTIVE_END_STATE
0x2009	<a href="#">Interrupt State 4[7:0]</a>	-	-	-	-	BPE_LO_STATE	BPE_LEVEL_STATE	BPE_ACTIVE_BGN_STATE	BPE_ACTIVE_END_STATE
0x200B	<a href="#">Interrupt Flag 1[7:0]</a>	THERM_SHDN_BGN_FLAG	THERM_SHDN_END_FLAG	THERM_WARN1_BGN_FLAG	THERM_WARN1_END_FLAG	THERMF_B_BGN_FLAG	THERMF_B_END_FLAG	OTP_FAIL_FLAG	SPK_OVC_FLAG
0x200C	<a href="#">Interrupt Flag 2[7:0]</a>	THERM_WARN2_BGN_FLAG	THERM_WARN2_END_FLAG	INT_SPK_MON_ERR_FLAG	INT_CLK_ERR_FLAG	-	CLK_RECOVER_FLAG	CLK_ERR_FLAG	DMON_ERR_FLAG

ADDRESS	NAME	MSB							LSB
0x200D	<a href="#">Interrupt Flag 3[7:0]</a>	-	-	PWRUP_DONE_FLAG	PWRDN_DONE_FLAG	PVDD_UVLO_SHDN_FLAG	VBAT_UVLO_SHDN_FLAG	DHT_ACTIVE_BGN_FLAG	DHT_ACTIVE_END_FLAG
0x200E	<a href="#">Interrupt Flag 4[7:0]</a>	-	-	-	-	BPE_L0_FLAG	BPE_LEL_FLAG	BPE_ACTIVE_BGN_FLAG	BPE_ACTIVE_END_FLAG
0x2010	<a href="#">Interrupt Enable 1[7:0]</a>	THERM_SHDN_BGN_EN	THERM_SHDN_END_EN	THERM_WARN1_BGN_EN	THERM_WARN1_END_EN	THERMF_B_BGN_EN	THERMF_B_END_EN	OTP_FAIL_EN	SPK_OVC_EN
0x2011	<a href="#">Interrupt Enable 2[7:0]</a>	THERM_WARN2_BGN_EN	THERM_WARN2_END_EN	INT_SPK_MON_ERR_EN	INT_CLK_ERR_EN	-	CLK_RECOVER_EN	CLK_ERR_EN	DMON_ERR_EN
0x2012	<a href="#">Interrupt Enable 3[7:0]</a>	-	-	PWRUP_DONE_EN	PWRDN_DONE_EN	PVDD_UVLO_SHDN_EN	VBAT_UVLO_SHDN_EN	DHT_ACTIVE_BGN_EN	DHT_ACTIVE_END_EN
0x2013	<a href="#">Interrupt Enable 4[7:0]</a>	-	-	-	-	BPE_L0_EN	BPE_LEL_EN	BPE_ACTIVE_BGN_EN	BPE_ACTIVE_END_EN
0x2015	<a href="#">Interrupt Flag Clear 1[7:0]</a>	THERM_SHDN_BGN_CLR	THERM_SHDN_END_CLR	THERM_WARN1_BGN_CLR	THERM_WARN1_END_CLR	THERMF_B_BGN_CLR	THERMF_B_END_CLR	OTP_FAIL_CLR	SPK_OVC_CLR
0x2016	<a href="#">Interrupt Flag Clear 2[7:0]</a>	THERM_WARN2_BGN_CLR	THERM_WARN2_END_CLR	INT_SPK_MON_ERR_CLR	INT_CLK_ERR_CLR	-	CLK_RECOVER_CLR	CLK_ERR_CLR	DMON_ERR_CLR
0x2017	<a href="#">Interrupt Flag Clear 3[7:0]</a>	-	-	PWRUP_DONE_CLR	PWRDN_DONE_CLR	PVDD_UVLO_SHDN_CLR	VBAT_UVLO_SHDN_CLR	DHT_ACTIVE_BGN_CLR	DHT_ACTIVE_END_CLR
0x2018	<a href="#">Interrupt Flag Clear 4[7:0]</a>	-	-	-	-	BPE_L0_CLR	BPE_LEL_CLR	BPE_ACTIVE_BGN_CLR	BPE_ACTIVE_END_CLR
0x201F	<a href="#">IRQ Control[7:0]</a>	-	-	-	-	-	IRQ_MODE	IRQ_PO_L	IRQ_EN
<b>Thermal Protection</b>									
0x2020	<a href="#">Thermal Warning Threshold[7:0]</a>	-	THERMWARN1_THRESH[6:0]						
0x2021	<a href="#">Warning Threshold 2[7:0]</a>	-	THERMWARN2_THRESH[6:0]						
0x2022	<a href="#">Thermal Shutdown Threshold[7:0]</a>	-	THERMSHDN_THRESH[6:0]						
0x2023	<a href="#">Thermal Hysteresis[7:0]</a>	-	-	-	-	-	-	THERM_HYST[1:0]	
0x2024	<a href="#">Thermal Foldback Settings[7:0]</a>	THERMFB_HOLD[1:0]		THERMFB_RLS[1:0]		THERMFB_SLOPE2[1:0]		THERMFB_SLOPE1[1:0]	
0x2027	<a href="#">Thermal Foldback Enable[7:0]</a>	-	-	-	-	-	-	-	THERMF_B_EN



ADDRESS	NAME	MSB							LSB
<b>Noise Gate and Idle Mode</b>									
0x2030	<a href="#">Noise Gate/Idle Mode Control[7:0]</a>	UNMUTE_THRESH[3:0]				MUTE_THRESH[3:0]			
0x2033	<a href="#">Noise Gate/Idle Mode Enables[7:0]</a>	-	-	-	-	-	-	-	NOISEGATE_EN
<b>Clock and Data Monitor Control</b>									
0x2038	<a href="#">Clock Monitor Control[7:0]</a>	-	CMON_BSELTOL[2:0]			CMON_ERRTOL[2:0]			CMON_AUTORESTART_EN
0x2039	<a href="#">Data Monitor Control[7:0]</a>	-	-	DMON_MAG_THRESH[1:0]	DMON_STUCK_THRES[1:0]	DMON_DURATION[1:0]			
0x203A	<a href="#">Speaker Monitor Threshold[7:0]</a>	SPKMON_THRESH[7:0]							
0x203B	<a href="#">Speaker Monitor Duration[7:0]</a>	-	-	-	-	SPKMON_DURATION[3:0]			
0x203F	<a href="#">Enable Controls[7:0]</a>	-	-	-	-	SPKMON_EN	DMON_MAG_EN	DMON_STUCK_EN	CMON_EN
<b>PCM Registers</b>									
0x2040	<a href="#">Pin Config[7:0]</a>	LV_EN_DRV[1:0]		ICC_DRV[1:0]		IRQ_DRV[1:0]		DOUT_DRV[1:0]	
0x2041	<a href="#">PCM Mode Config[7:0]</a>	PCM_CHANSZ[1:0]		PCM_FORMAT[2:0]			PCM_TX_INTERLEAVE	PCM_CHANSEL	PCM_TX_EXTRA_HIZ
0x2042	<a href="#">PCM Clock Setup[7:0]</a>	-	-	-	PCM_BCLKEDGE	PCM_BSEL[3:0]			
0x2043	<a href="#">PCM Sample Rate Setup 1[7:0]</a>	IVADC_SR[3:0]				PCM_SR[3:0]			
0x2044	<a href="#">PCM TX Control 1[7:0]</a>	-	-	PCM_VMON_SLOT[5:0]					
0x2045	<a href="#">PCM TX Control 2[7:0]</a>	-	-	PCM_IMON_SLOT[5:0]					
0x2046	<a href="#">PCM TX Control 3[7:0]</a>	-	-	PCM_PVDD_SLOT[5:0]					
0x2047	<a href="#">PCM TX Control 4[7:0]</a>	-	-	PCM_VBAT_SLOT[5:0]					
0x2048	<a href="#">PCM TX Control 5[7:0]</a>	-	-	PCM_DHT_ATN_SLOT[5:0]					
0x2049	<a href="#">PCM TX Control 6[7:0]</a>	-	-	PCM_STATUS_SLOT[5:0]					
0x204A	<a href="#">PCM TX Control 7[7:0]</a>	-	-	PCM_DSP_MONITOR_SLOT[5:0]					
0x204B	<a href="#">PCM TX Control 8[7:0]</a>	-	-	PCM_BPE_SLOT[5:0]					
0x204C	<a href="#">PCM Tx HiZ Control 1[7:0]</a>	PCM_TX_SLOT_HIZ[63:56]							
0x204D	<a href="#">PCM Tx HiZ Control 2[7:0]</a>	PCM_TX_SLOT_HIZ[55:48]							
0x204E	<a href="#">PCM Tx HiZ Control 3[7:0]</a>	PCM_TX_SLOT_HIZ[47:40]							
0x204F	<a href="#">PCM Tx HiZ Control 4[7:0]</a>	PCM_TX_SLOT_HIZ[39:32]							
0x2050	<a href="#">PCM Tx HiZ Control 5[7:0]</a>	PCM_TX_SLOT_HIZ[31:24]							

ADDRESS	NAME	MSB							LSB	
0x2051	<a href="#">PCM Tx HiZ Control6[7:0]</a>	PCM_TX_SLOT_HIZ[23:16]								
0x2052	<a href="#">PCM Tx HiZ Control 7[7:0]</a>	PCM_TX_SLOT_HIZ[15:8]								
0x2053	<a href="#">PCM Tx HiZ Control 8[7:0]</a>	PCM_TX_SLOT_HIZ[7:0]								
0x2055	<a href="#">PCM RX Source 1[7:0]</a>	-	-	-	-	-	-	PCM_DMMIX_CFG[1:0]		
0x2056	<a href="#">PCM RX Source 2[7:0]</a>	PCM_DMMIX_CH1_SOURCE[3:0]				PCM_DMMIX_CH0_SOURCE[3:0]				
0x2058	<a href="#">PCM Bypass Source[7:0]</a>	-	-	-	-	PCM_BYPASS_SOURCE[3:0]				
0x205D	<a href="#">PCM TX Source Enables[7:0]</a>	PCM_BP E_EN	PCM_ST ATUS_E N	PCM_D HT_ATN _EN	PCM_VB AT_EN	PCM_PV DD_EN	PCM_DS P MONIT OR_EN	PCM_IM ON_EN	PCM_V MON_E N	
0x205E	<a href="#">PCM Rx Enables[7:0]</a>	-	-	-	-	-	-	PCM_BY P_EN	PCM_RX _EN	
0x205F	<a href="#">PCM Tx Enables[7:0]</a>	-	-	-	-	-	-	-	PCM_TX _EN	
<b>Interchip Communication</b>										
0x2070	<a href="#">ICC Rx Enables A[7:0]</a>	ICC_RX _CH7_E N	ICC_RX _CH6_E N	ICC_RX _CH5_E N	ICC_RX _CH4_E N	ICC_RX _CH3_E N	ICC_RX _CH2_E N	ICC_RX _CH1_E N	ICC_RX _CH0_E N	
0x2071	<a href="#">ICC Rx Enables B[7:0]</a>	ICC_RX _CH15_ EN	ICC_RX _CH14_ EN	ICC_RX _CH13_ EN	ICC_RX _CH12_ EN	ICC_RX _CH11_ EN	ICC_RX _CH10_ EN	ICC_RX _CH9_E N	ICC_RX _CH8_E N	
0x2072	<a href="#">ICC Tx Control[7:0]</a>	-	ICC_INT ERLEAV E_MOD E	ICC_DA TA_SEL	-	ICC_TX_DEST[3:0]				
0x207F	<a href="#">ICC Enables[7:0]</a>	-	-	-	-	-	-	ICC_LIN K_EN	ICC_TX_ EN	
<b>Tone Generator Control</b>										
0x2083	<a href="#">Tone Generator and DC Config[7:0]</a>	-	-	TONE_AMPLITUDE[1:0]		TONE_CONFIG[3:0]				
0x2084	<a href="#">Tone Generator DC Level 1[7:0]</a>	TONE_DC[23:16]								
0x2085	<a href="#">Tone Generator DC Level 2[7:0]</a>	TONE_DC[15:8]								
0x2086	<a href="#">Tone Generator DC Level 3[7:0]</a>	TONE_DC[7:0]								
0x208F	<a href="#">Tone Generator Enable[7:0]</a>	-	-	-	-	-	-	-	TONE_E N	
<b>Speaker Path Control</b>										
0x2090	<a href="#">AMP volume control[7:0]</a>	-	SPK_VOL[6:0]							
0x2091	<a href="#">AMP Path Gain[7:0]</a>	-	-	-	SPK_GAIN_MAX[4:0]					

ADDRESS	NAME	MSB							LSB
0x2092	<a href="#">AMP DSP Config[7:0]</a>	-	SPK_WB AND_FIL T_EN	SPK_SA FE_EN	SPK_VO L_RMPD N_BYPA SS	SPK_VO L_RMPU P_BYPA SS	SPK_IN VERT	SPK_DIT H_EN	SPK_DC BLK_EN
0x2093	<a href="#">SSM Configuration[7:0]</a>	-	-	-	-	SPK_SS M_EN	SPK_SSM_MOD_INDEX[2:0]		
0x2094	<a href="#">SPK Class DG Threshold[7:0]</a>	-	-	-	SPK_DG_THRES[4:0]				
0x2095	<a href="#">SPK Class DG Headroom[7:0]</a>	-	-	SPK_DG_SEL[1:0]		SPK_DG_HEADROOM[3:0]			
0x2096	<a href="#">SPK Class DG Hold Time[7:0]</a>	-	SPK_DG_PEAK_HYST[2:0]			SPK_DG_HOLD_TIME[3:0]			
0x2097	<a href="#">SPK Class DG Delay[7:0]</a>	-	-	SPK_DG_DELAY[5:0]					
0x2098	<a href="#">SPK Class DG Mode[7:0]</a>	-	-	-	-	-	-	SPK_MODE[1:0]	
0x2099	<a href="#">SPK Class DG VBAT Level[7:0]</a>	-	-	-	-	-	VBATLOW_OK_LVL[2:0]		
0x209A	<a href="#">SPK Edge Control[7:0]</a>	-	-	-	-	-	SPK_FS W_SEL	-	-
0x209B	<a href="#">SPK Path Wideband Only Enable[7:0]</a>	-	-	-	-	-	-	-	SPK_WI DEBAND _ONLY_ _EN
0x209C	<a href="#">SPK Edge Control 1[7:0]</a>	-	-	-	-	SPK_SL_RATE_GMODE[3:0]			
0x209D	<a href="#">SPK Edge Control 2[7:0]</a>	SPK_SL_RATE_LS[3:0]				SPK_SL_RATE_HS[3:0]			
0x209E	<a href="#">Amp Clip Gain[7:0]</a>	-	-	-	-	SPK_GAIN[3:0]			
0x209F	<a href="#">Bypass Path Config[7:0]</a>	-	-	-	-	-	-	BYP_WB AND_FIL T_EN	BYP_IN VERT
0x20A0	<a href="#">Amplifier Supply Control[7:0]</a>	-	-	-	-	-	-	-	NOVBAT
0x20AF	<a href="#">AMP enables[7:0]</a>	-	-	-	-	-	-	SPK_FB _EN	SPK_EN
<b>Meas ADC</b>									
0x20B0	<a href="#">Meas ADC Sample Rate[7:0]</a>	-	-	MEAS_ADC_TEMP _SR[1:0]		MEAS_ADC_PVDD _SR[1:0]		MEAS_ADC_VBAT_ SR[1:0]	
0x20B1	<a href="#">Meas ADC PVDD Config[7:0]</a>	-	-	-	MEAS_A DC_PVD D_FILT_ EN	MEAS_ADC_PVDD_FILT_COEFF[3:0]			
0x20B2	<a href="#">Meas ADC VBAT Config[7:0]</a>	-	-	-	MEAS_A DC_VBA T_FILT_ EN	MEAS_ADC_VBAT_FILT_COEFF[3:0]			

ADDRESS	NAME	MSB							LSB
0x20B3	<a href="#">Meas ADC Thermal Config[7:0]</a>	-	-	-	MEAS_A DC_TEM P_FILT_ EN	MEAS_ADC_TEMP_FILT_COEFF[3:0]			
0x20B4	<a href="#">Meas ADC Readback Control 1[7:0]</a>	-	-	-	-	-	MEAS_A DC_THE RM_RD_ MODE	MEAS_A DC_VBA T_RD_M ODE	MEAS_A DC_PVD D_RD_M ODE
0x20B5	<a href="#">Meas ADC Readback Control 2[7:0]</a>	-	-	-	-	-	MEAS_A DC_THE RM_RD_ UPD	MEAS_A DC_VBA T_RD_U PD	MEAS_A DC_PVD D_RD_U PD
0x20B6	<a href="#">Meas ADC PVDD Readback MSB[7:0]</a>	MEAS_ADC_PVDD_DATA[8:1]							
0x20B7	<a href="#">Meas ADC PVDD Readback LSB[7:0]</a>	-	-	-	-	-	-	-	MEAS_A DC_PVD D_DATA [0]
0x20B8	<a href="#">Meas ADC VBAT Readback MSB[7:0]</a>	MEAS_ADC_VBAT_DATA[8:1]							
0x20B9	<a href="#">Meas ADC VBAT Readback LSB[7:0]</a>	-	-	-	-	-	-	-	MEAS_A DC_VBA T_DATA[ 0]
0x20BA	<a href="#">Meas ADC Temp Readback MSB[7:0]</a>	MEAS_ADC_THERM_DATA[8:1]							
0x20BB	<a href="#">Meas ADC Temp Readback LSB[7:0]</a>	-	-	-	-	-	-	-	MEAS_A DC_THE RM_DAT A[0]
0x20BC	<a href="#">Meas ADC Lowest PVDD Readback MSB[7:0]</a>	LOWEST_PVDD_DATA[8:1]							
0x20BD	<a href="#">Meas ADC Lowest PVDD Readback LSB[7:0]</a>	-	-	-	-	-	-	-	LOWES T_PVDD _DATA[0 ]
0x20BE	<a href="#">Meas ADC Lowest VBAT Readback MSB[7:0]</a>	LOWEST_VBAT_DATA[8:1]							
0x20BF	<a href="#">Meas ADC Lowest VBAT Readback LSB[7:0]</a>	-	-	-	-	-	-	-	LOWES T_VBAT _DATA[0 ]
0x20C7	<a href="#">Meas ADC Config[7:0]</a>	-	-	-	-	-	-	MEAS_A DC_VBA T_EN	MEAS_A DC_PVD D_EN
<b>Dynamic Headroom Tracking</b>									
0x20D0	<a href="#">DHT Configuration 1[7:0]</a>	-	-	-	-	DHT_VROT_PNT[3:0]			

ADDRESS	NAME	MSB							LSB
0x20D1	<a href="#">Limiter Configuration 1[7:0]</a>	-	-	-	DHT_HR[4:0]				
0x20D2	<a href="#">Limiter Configuration 2[7:0]</a>	-	-	DHT_LIM_THRESH[4:0]					DHT_LIM_MODE
0x20D3	<a href="#">DHT Configuration 2[7:0]</a>	-	-	-	DHT_MAX_ATN[4:0]				
0x20D4	<a href="#">DHT Configuration 3[7:0]</a>	-	-	-	-	DHT_ATK_RATE[3:0]			
0x20D5	<a href="#">DHT Configuration 4[7:0]</a>	-	-	-	-	DHT_RLS_RATE[3:0]			
0x20D6	<a href="#">DHT Supply Hysteresis Configuration[7:0]</a>	-	-	-	-	DHT_SUPPLY_HYST[2:0]			DHT_SUPPLY_HYST_EN
0x20DF	<a href="#">DHT Enable[7:0]</a>	-	-	-	-	-	-	-	DHT_EN
<b>I_V Sense Path Control</b>									
0x20E0	<a href="#">I_V Sense Path Config[7:0]</a>	-	-	-	-	IVADC_WBAND_FILTER_EN	IVADC_DITH_EN	IVADC_I_DCBLK_EN	IVADC_V_DCBLK_EN
0x20E4	<a href="#">I_V Sense Path Enables[7:0]</a>	-	-	-	-	-	-	IVADC_I_EN	IVADC_V_EN
<b>Brownout Prevention Engine</b>									
0x20E5	<a href="#">BPE State[7:0]</a>	-	-	-	-	-	BPE_STATE[2:0]		
0x20E6	<a href="#">BPE L3 Threshold MSB[7:0]</a>	BPE_L3_VTHRESH[8:1]							
0x20E7	<a href="#">BPE L3 Threshold LSB[7:0]</a>	-	-	-	-	-	-	-	BPE_L3_VTHRESH[0]
0x20E8	<a href="#">BPE L2 Threshold MSB[7:0]</a>	BPE_L2_VTHRESH[8:1]							
0x20E9	<a href="#">BPE L2 Threshold LSB[7:0]</a>	-	-	-	-	-	-	-	BPE_L2_VTHRESH[0]
0x20EA	<a href="#">BPE L1 Threshold MSB[7:0]</a>	BPE_L1_VTHRESH[8:1]							
0x20EB	<a href="#">BPE L1 Threshold LSB[7:0]</a>	-	-	-	-	-	-	-	BPE_L1_VTHRESH[0]
0x20EC	<a href="#">BPE L0 Threshold MSB[7:0]</a>	BPE_L0_VTHRESH[8:1]							
0x20ED	<a href="#">BPE L0 Threshold LSB[7:0]</a>	-	-	-	-	-	-	-	BPE_L0_VTHRESH[0]
0x20EE	<a href="#">BPE L3 Dwell and Hold Time[7:0]</a>	-	-	BPE_L3_DWELL[2:0]			BPE_L3_HOLD[2:0]		
0x20EF	<a href="#">BPE L2 Dwell and Hold Time[7:0]</a>	-	-	BPE_L2_DWELL[2:0]			BPE_L2_HOLD[2:0]		

ADDRESS	NAME	MSB						LSB
0x20F0	<a href="#">BPE L1 Dwell and Hold Time[7:0]</a>	-	-	BPE_L1_DWELL[2:0]			BPE_L1_HOLD[2:0]	
0x20F1	<a href="#">BPE L0 Hold Time[7:0]</a>	-	-	-	-	-	BPE_L0_HOLD[2:0]	
0x20F2	<a href="#">BPE L3 Attack and Release Step[7:0]</a>	-	-	-	-	BPE_L3_STEP[3:0]		
0x20F3	<a href="#">BPE L2 Attack and Release Step[7:0]</a>	-	-	-	-	BPE_L2_STEP[3:0]		
0x20F4	<a href="#">BPE L1 Attack and Release Step[7:0]</a>	-	-	-	-	BPE_L1_STEP[3:0]		
0x20F5	<a href="#">BPE L0 Attack and Release Step[7:0]</a>	-	-	-	-	BPE_L0_STEP[3:0]		
0x20F6	<a href="#">BPE L3 Max Gain Attn[7:0]</a>	-	-	-	BPE_L3_MAXATTN[4:0]			
0x20F7	<a href="#">BPE L2 Max Gain Attn[7:0]</a>	-	-	-	BPE_L2_MAXATTN[4:0]			
0x20F8	<a href="#">BPE L1 Max Gain Attn[7:0]</a>	-	-	-	BPE_L1_MAXATTN[4:0]			
0x20F9	<a href="#">BPE L0 Max Gain Attn[7:0]</a>	-	-	-	BPE_L0_MAXATTN[4:0]			
0x20FA	<a href="#">BPE L3 Gain Attack and Rls Rates[7:0]</a>	-	-	BPE_L3_GAIN_RLS[2:0]		BPE_L3_GAIN_ATK[2:0]		
0x20FB	<a href="#">BPE L2 Gain Attack and Rls Rates[7:0]</a>	-	-	BPE_L2_GAIN_RLS[2:0]		BPE_L2_GAIN_ATK[2:0]		
0x20FC	<a href="#">BPE L1 Gain Attack and Rls Rates[7:0]</a>	-	-	BPE_L1_GAIN_RLS[2:0]		BPE_L1_GAIN_ATK[2:0]		
0x20FD	<a href="#">BPE L0 Gain Attack and Rls Rates[7:0]</a>	-	-	BPE_L0_GAIN_RLS[2:0]		BPE_L0_GAIN_ATK[2:0]		
0x20FE	<a href="#">BPE L3 Limiter Config[7:0]</a>	-	-	-	-	BPE_L3_LIM[3:0]		
0x20FF	<a href="#">BPE L2 Limiter Config[7:0]</a>	-	-	-	-	BPE_L2_LIM[3:0]		
0x2100	<a href="#">BPE L1 Limiter Config[7:0]</a>	-	-	-	-	BPE_L1_LIM[3:0]		
0x2101	<a href="#">BPE L0 Limiter Config[7:0]</a>	-	-	-	-	BPE_L0_LIM[3:0]		
0x2102	<a href="#">BPE L3 Limiter Attack and Release Rates[7:0]</a>	-	-	BPE_L3_LIM_RLS[2:0]		BPE_L3_LIM_ATK[2:0]		
0x2103	<a href="#">BPE L2 Limiter Attack and Release Rates[7:0]</a>	-	-	BPE_L2_LIM_RLS[2:0]		BPE_L2_LIM_ATK[2:0]		
0x2104	<a href="#">BPE L1 Limiter Attack and Release Rates[7:0]</a>	-	-	BPE_L1_LIM_RLS[2:0]		BPE_L1_LIM_ATK[2:0]		
0x2105	<a href="#">BPE L0 Limiter Attack and Release Rates[7:0]</a>	-	-	BPE_L0_LIM_RLS[2:0]		BPE_L0_LIM_ATK[2:0]		
0x2106	<a href="#">BPE Threshold Hysteresis[7:0]</a>	BPE_VTHRESH_HYST[7:0]						
0x2107	<a href="#">BPE Infinite Hold Clear[7:0]</a>	-	-	-	-	-	-	BPE_HL D_RLS

ADDRESS	NAME	MSB							LSB
0x2108	<a href="#">BPE Supply Source[7:0]</a>	-	-	-	-	-	-	-	BPE_SRC_SEL
0x2109	<a href="#">BPE Lowest State[7:0]</a>	-	-	-	-	-	BPE_LOWEST[2:0]		
0x210A	<a href="#">BPE Lowest Gain[7:0]</a>	BPE_LOWEST_GAIN[7:0]							
0x210B	<a href="#">BPE Lowest Limiter[7:0]</a>	BPE_LOWEST_LIMIT[7:0]							
0x210D	<a href="#">BPE Enable[7:0]</a>	-	-	-	-	-	-	BPE_LIM_EN	BPE_EN
<b>System Configuration</b>									
0x210E	<a href="#">Auto-Restart Behavior[7:0]</a>	-	-	-	-	OVC_AUTORESTART_EN	THERM_AUTORESTART_EN	VBAT_AUTORESTART_EN	PVDD_AUTORESTART_EN
0x210F	<a href="#">Global Enable[7:0]</a>	-	-	-	-	-	-	-	EN
<b>Device and Revision ID</b>									
0x21FF	<a href="#">Revision ID[7:0]</a>	REV_ID[7:0]							

**Register Details**

**Software Reset (0x2000)**

BIT	7	6	5	4	3	2	1	0
Field	-	-	-	-	-	-	-	RST
Reset	-	-	-	-	-	-	-	0b0
Access Type	-	-	-	-	-	-	-	Write Only

BITFIELD	BITS	RES	DESCRIPTION	DECODE
RST	0	-	This bit field is used to trigger a software reset event. Writing a 1 resets the device and returns the control registers to their power-on reset states. Writing a 0 has no effect, and readback always returns 0.	0: No action 1: Triggers a software reset event

**Interrupt Raw 1 (0x2001)**

BIT	7	6	5	4	3	2	1	0
Field	THERMSH_DN_BGN_RAW	THERMSH_DN_END_RAW	THERMWA_RN1_BGN_RAW	THERMWA_RN1_END_RAW	THERMFB_BGN_RAW	THERMFB_END_RAW	OTP_FAIL_RAW	SPK_OVC_RAW
Reset	0b0	0b0	0b0	0b0	0b0	0b0	0b0	0b0
Access Type	Read Only	Read Only	Read Only	Read Only	Read Only	Read Only	Read Only	Read Only

BITFIELD	BITS	RES	DESCRIPTION	DECODE
THERMSH_DN_BGN_RAW	7	-	Raw value of thermal shutdown begin indicator	0: Die temperature below thermal shutdown limit 1: Die temperature above thermal shutdown limit

BITFIELD	BITS	RES	DESCRIPTION	DECODE
THERMSH DN_END_ RAW	6	–	Raw value of thermal shutdown end indicator	0: Die temperature above thermal shutdown limit 1: Die temperature has dropped below thermal shutdown limit
THERMWA RN1_BGN_ RAW	5	–	Raw value of thermal-warning1 begin indicator	0: Die temperature below thermal-warning1 limit 1: Die temperature above thermal-warning1 limit
THERMWA RN1_END_ RAW	4	–	Raw value of thermal-warning1 end indicator	0: Die temperature above thermal-warning1 limit 1: Die temperature has dropped below thermal-warning1 limit
THERMFB_ BGN_RAW	3	–	Raw value of thermal foldback begin	0: Thermal foldback is not active 1: Thermal foldback is active
THERMFB_ END_RAW	2	–	Raw value of thermal foldback end	0: Thermal foldback is active 1: Thermal foldback has ended
OTP_FAIL_ RAW	1	–	Raw status of OTP load fail	0: No OTP load failure 1: OTP load routine did not complete successfully
SPK_OVC_ RAW	0	–	Raw value of speaker overcurrent limit	0: Speaker overcurrent limit inactive 1: Speaker overcurrent limit active

**Interrupt Raw 2 (0x2002)**

BIT	7	6	5	4	3	2	1	0
<b>Field</b>	THERMWA RN2_BGN_ RAW	THERMWA RN2_END_ RAW	INT_SPKM ON_ERR_ RAW	INT_CLK_E RR_RAW	–	CLK_RECO VER_RAW	CLK_ERR_ RAW	DMON_ER R_RAW
<b>Reset</b>	0b0	0b0	0b0	0x0	–	0x0	0x0	0b0
<b>Access Type</b>	Read Only	Read Only	Read Only	Read Only	–	Read Only	Read Only	Read Only

BITFIELD	BITS	RES	DESCRIPTION	DECODE
THERMWA RN2_BGN_ RAW	7	–	Raw value of thermal-warning2 begin indicator	0: Die temperature below thermal-warning2 limit 1: Die temperature above thermal-warning2 limit
THERMWA RN2_END_ RAW	6	–	Raw value of thermal-warning2 end indicator	0: Die temperature above thermal-warning2 limit 1: Die temperature has dropped below thermal-warning2 limit
INT_SPKM ON_ERR_ RAW	5	–	Raw value of the internal speaker monitor status indicator	0: Internal speaker monitor not reporting data error 1: Internal speaker monitor reporting data error
INT_CLK_E RR_RAW	4	–	Raw value of internal clock error indicator	0: Internal clock monitor not reporting clock error 1: Internal clock monitor reporting clock error



BITFIELD	BITS	RES	DESCRIPTION	DECODE
CLK_RECOVER_RAW	2	–	Raw value of the external clock monitor error recovery indicator	0: Clock monitor not reporting clock error recovery 1: Clock monitor reporting clock error recovery
CLK_ERR_RAW	1	–	Raw value of the external clock monitor error indicator	0: No external clock error detected 1: Clock monitor reporting clock error
DMON_ERR_RAW	0	–	Raw value of external data monitor error indicator	0: No external data error detected 1: Data monitor reporting data error

**Interrupt Raw 3 (0x2003)**

BIT	7	6	5	4	3	2	1	0
Field	–	–	PWRUP_DONE_RAW	PWRDN_DONE_RAW	PVDD_UVLO_SHDN_RAW	VBAT_UVLO_SHDN_RAW	DHT_ACTIVE_BGN_RAW	DHT_ACTIVE_END_RAW
Reset	–	–	0b0	0b0	0b0	0b0	0b0	0b0
Access Type	–	–	Read Only	Read Only	Read Only	Read Only	Read Only	Read Only

BITFIELD	BITS	RES	DESCRIPTION	DECODE
PWRUP_DONE_RAW	5	–	Raw value of power-up done	0: Device is not reporting a power-up event 1: Device is reporting a power-up into the active state with the speaker amplifier enabled
PWRDN_DONE_RAW	4	–	Raw value of power-down done	0: Device is not reporting a power-down into software shutdown event 1: Device is reporting a power-down into software shutdown event
PVDD_UVLO_SHDN_RAW	3	–	Raw value of PVDD UVLO error indicator	0: No PVDD UVLO error 1: PVDD below UVLO threshold in the active state
VBAT_UVLO_SHDN_RAW	2	–	Raw value of VBAT UVLO error indicator	0: No VBAT UVLO error 1: VBAT below UVLO threshold in the active state
DHT_ACTIVE_BGN_RAW	1	–	Raw value of DHT active begin	0: DHT is not active 1: DHT is active
DHT_ACTIVE_END_RAW	0	–	Raw value of DHT active end	0: DHT is currently active or has not yet applied attenuation 1: DHT activity has ended

**Interrupt Raw 4 (0x2004)**

BIT	7	6	5	4	3	2	1	0
Field	–	–	–	–	BPE_LO_RAW	BPE_LEVEL_RAW	BPE_ACTIVE_BGN_RAW	BPE_ACTIVE_END_RAW
Reset	–	–	–	–	0x0	0x0	0x0	0x0
Access Type	–	–	–	–	Read Only	Read Only	Read Only	Read Only

BITFIELD	BITS	RES	DESCRIPTION	DECODE
BPE_L0_RAW	3	–	Indicates that BPE has transitioned into level 0	0: BPE controller is not in level 0 1: BPE controller has transitioned into level 0
BPE_LEVEL_RAW	2	–	Indicates that BPE has transitioned between levels	0: BPE is static 1: BPE level is changing
BPE_ACTIVE_BGN_RAW	1	–	Indicates that the BPE is active	0: BPE is inactive 1: BPE is active
BPE_ACTIVE_END_RAW	0	–	Indicates that the BPE is no longer active	0: BPE is active 1: BPE is inactive

### Interrupt State 1 (0x2006)

BIT	7	6	5	4	3	2	1	0
Field	THERMSHDN_BGN_STATE	THERMSHDN_END_STATE	THERMWARN1_BGN_STATE	THERMWARN1_END_STATE	THERMFB_BGN_STATE	THERMFB_END_STATE	OTP_FAIL_STATE	SPK_OVC_STATE
Reset	0b0	0b0	0b0	0b0	0b0	0b0	0b0	0b0
Access Type	Read Only	Read Only	Read Only	Read Only	Read Only	Read Only	Read Only	Read Only

BITFIELD	BITS	RES	DESCRIPTION	DECODE
THERMSHDN_BGN_STATE	7	–	Unmaskable interrupt state, cleared by THERMSHDN_BGN_CLR.	0: No rising edge of THERMSHDN_BGN_RAW since last THERMSHDN_BGN_CLR 1: Rising edge of THERMSHDN_BGN_RAW since last THERMSHDN_BGN_CLR
THERMSHDN_END_STATE	6	–	Unmaskable interrupt state, cleared by THERMSHDN_END_CLR.	0: No rising edge of THERMSHDN_END_RAW since last THERMSHDN_END_CLR 1: Rising edge of THERMSHDN_END_RAW since last THERMSHDN_END_CLR
THERMWARN1_BGN_STATE	5	–	Unmaskable interrupt state, cleared by THERMWARN1_BGN_CLR.	0: No rising edge of THERMWARN1_BGN_RAW since last THERMWARN1_BGN_CLR 1: Rising edge of THERMWARN1_BGN_RAW since last THERMWARN1_BGN_CLR
THERMWARN1_END_STATE	4	–	Unmaskable interrupt state, cleared by THERMWARN1_END_CLR.	0: No rising edge of THERMWARN1_END_RAW since last THERMWARN1_END_CLR 1: Rising edge of THERMWARN1_END_RAW since last THERMWARN1_END_CLR
THERMFB_BGN_STATE	3	–	Unmaskable interrupt state, cleared by THERMFB_BGN_CLR.	0: No rising edge of THERMFB_BGN_RAW since last THERMFB_BGN_CLR 1: Rising edge of THERMFB_BGN_RAW since last THERMFB_BGN_CLR

BITFIELD	BITS	RES	DESCRIPTION	DECODE
THERMFB_END_STATE	2	–	Unmaskable interrupt state, cleared by THERMFB_END_CLR.	0: No rising edge of THERMFB_END_RAW since last THERMFB_END_CLR 1: Rising edge of THERMFB_END_RAW since last THERMFB_END_CLR
OTP_FAIL_STATE	1	–	Unmaskable interrupt state, cleared by OTP_FAIL_CLR.	0: No rising edge of OTP_FAIL_RAW since last OTP_FAIL_CLR 1: Rising edge of OTP_FAIL_RAW since last OTP_FAIL_CLR
SPK_OVC_STATE	0	–	Unmaskable interrupt state, cleared by SPK_OVC_CLR.	0: No rising edge of SPK_OVC_RAW since last SPK_OVC_CLR 1: Rising edge of SPK_OVC_RAW since last SPK_OVC_CLR

### Interrupt State 2 (0x2007)

BIT	7	6	5	4	3	2	1	0
Field	THERMWAR N2_BGN_ STATE	THERMWAR N2_END_ STATE	INT_SPKM ON_ERR_S TATE	INT_CLK_E RR_STATE	–	CLK_RECO VER_STAT E	CLK_ERR_ STATE	DMON_ER R_STATE
Reset	0b0	0b0	0b0	0x0	–	0x0	0x0	0b0
Access Type	Read Only	Read Only	Read Only	Read Only	–	Read Only	Read Only	Read Only

BITFIELD	BITS	RES	DESCRIPTION	DECODE
THERMWAR N2_BGN_ STATE	7	–	Unmaskable interrupt state, cleared by THERMWAR N2_BGN_CLR.	0: No rising edge of THERMWAR N2_BGN_RAW since last THERMWAR N2_BGN_CLR 1: Rising edge of THERMWAR N2_BGN_RAW since last THERMWAR N2_BGN_CLR
THERMWAR N2_END_ STATE	6	–	Unmaskable interrupt state, cleared by THERMWAR N2_END_CLR.	0: No rising edge of THERMWAR N2_END_RAW since last THERMWAR N2_END_CLR 1: Rising edge of THERMWAR N2_END_RAW since last THERMWAR N2_END_CLR
INT_SPKM ON_ERR_S TATE	5	–	Unmaskable interrupt state, cleared by INT_SPKM ON_ERR_CLR.	0: No rising edge of INT_SPKM ON_ERR_RAW since last INT_SPKM ON_ERR_CLR 1: Rising edge of INT_SPKM ON_ERR_RAW since last INT_SPKM ON_ERR_CLR
INT_CLK_E RR_STATE	4	–	Unmaskable interrupt state, cleared by INT_CLK_E RR_CLR.	0: No rising edge of INT_CLK_E RR_RAW since last INT_CLK_E RR_CLR 1: Rising edge of INT_CLK_E RR_RAW since last INT_CLK_E RR_CLR
CLK_RECO VER_STAT E	2	–	Unmaskable interrupt state, cleared by CLK_RECO VER_CLR.	0: No rising edge of CLK_RECO VER_RAW since last CLK_RECO VER_CLR 1: Rising edge of CLK_RECO VER_RAW since last CLK_RECO VER_CLR

BITFIELD	BITS	RES	DESCRIPTION	DECODE
CLK_ERR_STATE	1	–	Unmaskable interrupt state, cleared by CLK_ERR_CLR.	0: No rising edge of CLK_ERR_RAW since last CLK_ERR_CLR 1: Rising edge of CLK_ERR_RAW since last CLK_ERR_CLR
DMON_ERR_STATE	0	–	Unmaskable interrupt state, cleared by DMON_ERR_CLR.	0: No rising edge of DMON_ERR_RAW since last DMON_ERR_CLR 1: Rising edge of DMON_ERR_RAW since last DMON_ERR_CLR

**Interrupt State 3 (0x2008)**

BIT	7	6	5	4	3	2	1	0
Field	–	–	PWRUP_DONE_STATE	PWRDN_DONE_STATE	PVDD_UVLO_SHDN_STATE	VBAT_UVLO_SHDN_STATE	DHT_ACTIVE_BGN_STATE	DHT_ACTIVE_END_STATE
Reset	–	–	0b0	0b0	0b0	0b0	0b0	0b0
Access Type	–	–	Read Only	Read Only	Read Only	Read Only	Read Only	Read Only

BITFIELD	BITS	RES	DESCRIPTION	DECODE
PWRUP_DONE_STATE	5	–	Unmaskable interrupt state, cleared by PWRUP_DONE_CLR.	0: No rising edge of PWRUP_DONE_RAW since last PWRUP_DONE_CLR 1: Rising edge of PWRUP_DONE_RAW since last PWRUP_DONE_CLR
PWRDN_DONE_STATE	4	–	Unmaskable interrupt state, cleared by PWRDN_DONE_CLR.	0: No rising edge of PWRDN_DONE_RAW since last PWRDN_DONE_CLR 1: Rising edge of PWRDN_DONE_RAW since last PWRDN_DONE_CLR
PVDD_UVLO_SHDN_STATE	3	–	Unmaskable interrupt state, cleared by PVDD_UVLO_SHDN_CLR.	0: No rising edge of PVDD_UVLO_SHDN_RAW since last PVDD_UVLO_SHDN_CLR 1: Rising edge of PVDD_UVLO_SHDN_RAW since last PVDD_UVLO_SHDN_CLR
VBAT_UVLO_SHDN_STATE	2	–	Unmaskable interrupt state, cleared by VBAT_UVLO_SHDN_CLR.	0: No rising edge of VBAT_UVLO_SHDN_RAW since last VBAT_UVLO_SHDN_CLR 1: Rising edge of VBAT_UVLO_SHDN_RAW since last VBAT_UVLO_SHDN_CLR
DHT_ACTIVE_BGN_STATE	1	–	Unmaskable interrupt state, cleared by DHT_ACTIVE_BGN_CLR.	0: No rising edge of DHT_ACTIVE_BGN_RAW since last DHT_ACTIVE_BGN_CLR 1: Rising edge of DHT_ACTIVE_BGN_RAW since last DHT_ACTIVE_BGN_CLR
DHT_ACTIVE_END_STATE	0	–	Unmaskable interrupt state, cleared by DHT_ACTIVE_END_CLR.	0: No rising edge of DHT_ACTIVE_END_RAW since last DHT_ACTIVE_END_CLR 1: Rising edge of DHT_ACTIVE_END_RAW since last DHT_ACTIVE_END_CLR

Interrupt State 4 (0x2009)

BIT	7	6	5	4	3	2	1	0
Field	–	–	–	–	BPE_L0_ST ATE	BPE_LEVE L_STATE	BPE_ACTIV E_BGN_ST ATE	BPE_ACTIV E_END_ST ATE
Reset	–	–	–	–	0x0	0x0	0x0	0x0
Access Type	–	–	–	–	Read Only	Read Only	Read Only	Read Only

BITFIELD	BITS	RES	DESCRIPTION	DECODE
BPE_L0_ST ATE	3	–	Unmaskable interrupt state, cleared by BPE_L0_CLR.	0: No rising edge of BPE_L0_RAW since last BPE_L0_CLR 1: Rising edge of BPE_L0_RAW since last BPE_L0_CLR
BPE_LEVE L_STATE	2	–	Unmaskable interrupt state, cleared by BPE_LEVEL_CLR.	0: No rising edge of BPE_LEVEL_RAW since last BPE_LEVEL_CLR 1: Rising edge of BPE_LEVEL_RAW since last BPE_LEVEL_CLR
BPE_ACTIV E_BGN_ST ATE	1	–	Unmaskable interrupt state, cleared by BPE_ACTIVE_END_CLR.	0: No rising edge of BPE_ACTIVE_BGN_RAW since last BPE_ACTIVE_BGN_CLR 1: Rising edge of BPE_ACTIVE_BGN_RAW since last BPE_ACTIVE_BGN_CLR
BPE_ACTIV E_END_ST ATE	0	–	Unmaskable interrupt state, cleared by BPE_ACTIVE_END_CLR.	0: No rising edge of BPE_ACTIVE_END_RAW since last BPE_ACTIVE_END_CLR 1: Rising edge of BPE_ACTIVE_END_RAW since last BPE_ACTIVE_END_CLR

Interrupt Flag 1 (0x200B)

BIT	7	6	5	4	3	2	1	0
Field	THERMSH DN_BGN_F LAG	THERMSH DN_END_F LAG	THERMWA RN1_BGN_ FLAG	THERMWA RN1_END_ FLAG	THERMFB BGN_FLAG	THERMFB END_FLAG	OTP_FAIL_ FLAG	SPK_OVC_ FLAG
Reset	0b0	0b0	0b0	0b0	0b0	0b0	0b0	0b0
Access Type	Read Only	Read Only	Read Only	Read Only	Read Only	Read Only	Read Only	Read Only

BITFIELD	BITS	RES	DESCRIPTION	DECODE
THERMSH DN_BGN_F LAG	7	–	Thermal shutdown begin event maskable interrupt flag. Masked by THERMSHDN_END_EN and cleared by THERMSHDN_END_CLR. If IRQ is enabled, an interrupt is generated on a flag bit rising edge.	0: No rising edge of THERMSHDN_BGN_RAW since last THERMSHDN_BGN_CLR or THERMSHDN_BGN_EN is low 1: THERMSHDN_BGN_EN is high and rising edge of THERMSHDN_BGN_RAW since last THERMSHDN_BGN_CLR

BITFIELD	BITS	RES	DESCRIPTION	DECODE
THERMSH DN_END_F LAG	6	–	Thermal shutdown end event maskable interrupt flag. Masked by THERMSHDN_END_EN and cleared by THERMSHDN_END_CLR. If IRQ is enabled, an interrupt is generated on a flag bit rising edge.	0: No rising edge of THERMSHDN_END_RAW since last THERMSHDN_END_CLR or THERMSHDN_END_EN is low 1: THERMSHDN_END_EN is high and rising edge of THERMSHDN_END_RAW since last THERMSHDN_END_CLR
THERMWA RN1_BGN_ FLAG	5	–	Thermal-warning1 begin event maskable interrupt flag. Masked by THERMWARN1_BGN_EN and cleared by THERMWARN1_BGN_CLR. If IRQ is enabled, an interrupt is generated on a flag bit rising edge.	0: No rising edge of THERMWARN1_BGN_RAW since last THERMWARN1_BGN_CLR or THERMWARN1_BGN_EN is low 1: THERMWARN1_BGN_EN is high and rising edge of THERMWARN1_BGN_RAW since last THERMWARN1_BGN_CLR
THERMWA RN1_END_ FLAG	4	–	Thermal-warning1 end event maskable interrupt flag. Masked by THERMWARN1_END_EN and cleared by THERMWARN1_END_CLR. If IRQ is enabled, an interrupt is generated on a flag bit rising edge.	0: No rising edge of THERMWARN1_END_RAW since last THERMWARN1_END_CLR or THERMWARN1_END_EN is low 1: THERMWARN1_END_EN is high and rising edge of THERMWARN1_END_RAW since last THERMWARN1_END_CLR
THERMFB_ BGN_FLAG	3	–	Thermal foldback begin event maskable interrupt flag. Masked by THERMFB_BGN_EN and cleared by THERMFB_BGN_CLR. If IRQ is enabled, an interrupt is generated on a flag bit rising edge.	0: No rising edge of THERMFB_BGN_RAW since last THERMFB_BGN_CLR or THERMFB_BGN_EN is low 1: THERMFB_BGN_EN is high and rising edge of THERMFB_BGN_RAW since last THERMFB_BGN_CLR
THERMFB_ END_FLAG	2	–	Thermal foldback end event maskable interrupt flag. Masked by THERMFB_END_EN and cleared by THERMFB_END_CLR. If IRQ is enabled, an interrupt is generated on a flag bit rising edge.	0: No rising edge of THERMFB_END_RAW since last THERMFB_END_CLR or THERMFB_END_EN is low 1: THERMFB_END_EN is high and rising edge of THERMFB_END_RAW since last THERMFB_END_CLR
OTP_FAIL_ FLAG	1	–	OTP load routine fail event maskable interrupt flag. Masked by OTP_FAIL_EN and cleared by OTP_FAIL_CLR. If IRQ is enabled, an interrupt is generated on a flag bit rising edge.	0: No rising edge of OTP_FAIL_RAW since last OTP_FAIL_CLR or OTP_FAIL_EN is low 1: OTP_FAIL_EN is high and rising edge of OTP_FAIL_RAW since last OTP_FAIL_CLR
SPK_OVC_ FLAG	0	–	Speaker overcurrent event maskable interrupt flag. Masked by SPK_OVC_EN and cleared by SPK_OVC_CLR. If IRQ is enabled, an interrupt is generated on a flag bit rising edge.	0: No rising edge of SPK_OVC_RAW since last SPK_OVC_CLR or SPK_OVC_EN is low 1: SPK_OVC_EN is high and rising edge of SPK_OVC_RAW since last SPK_OVC_CLR

Interrupt Flag 2 (0x200C)

BIT	7	6	5	4	3	2	1	0
Field	THERMWAR N2_BGN_ FLAG	THERMWAR N2_END_ FLAG	INT_SPKM ON_ERR_F LAG	INT_CLK_E RR_FLAG	–	CLK_RECO VER_FLAG	CLK_ERR_ FLAG	DMON_ER R_FLAG
Reset	0b0	0b0	0b0	0x0	–	0x0	0x0	0b0
Access Type	Read Only	Read Only	Read Only	Read Only	–	Read Only	Read Only	Read Only

BITFIELD	BITS	RES	DESCRIPTION	DECODE
THERMWAR N2_BGN_ FLAG	7	–	Thermal-warning2 begin event maskable interrupt flag. Masked by THERMWAR N2_BGN_EN and cleared by THERMWAR N2_BGN_CLR. If IRQ is enabled, an interrupt is generated on a flag bit rising edge.	0: No rising edge of THERMWAR N2_BGN_RAW since last THERMWAR N2_BGN_CLR or THERMWAR N2_BGN_EN is low 1: THERMWAR N2_BGN_EN is high and rising edge of THERMWAR N2_BGN_RAW since last THERMWAR N2_BGN_CLR
THERMWAR N2_END_ FLAG	6	–	Thermal-warning2 end event maskable interrupt flag. Masked by THERMWAR N2_END_EN and cleared by THERMWAR N2_END_CLR. If IRQ is enabled, an interrupt is generated on a flag bit rising edge.	0: No rising edge of THERMWAR N2_END_RAW since last THERMWAR N2_END_CLR or THERMWAR N2_END_EN is low 1: THERMWAR N2_END_EN is high and rising edge of THERMWAR N2_END_RAW since last THERMWAR N2_END_CLR
INT_SPKM ON_ERR_F LAG	5	–	Internal speaker data monitor error event maskable interrupt flag. Masked by INT_SPKMON_ERR_EN and cleared by INT_SPKMON_ERR_CLR. If IRQ is enabled, an interrupt is generated on a flag bit rising edge.	0: No rising edge of INT_SPKMON_ERR_RAW since last INT_SPKMON_ERR_CLR or INT_SPKMON_ERR_EN is low 1: INT_SPKMON_ERR_EN high and rising edge of INT_SPKMON_ERR_RAW since last INT_SPKMON_ERR_CLR
INT_CLK_E RR_FLAG	4	–	Internal clock monitor error event maskable interrupt flag. Masked by INT_CLK_ERR_EN and cleared by INT_CLK_ERR_CLR. If IRQ is enabled, an interrupt is generated on a flag bit rising edge.	0: No rising edge of INT_CLK_ERR_RAW since last INT_CLK_ERR_CLR or INT_CLK_ERR_EN is low 1: INT_CLK_ERR_EN high and rising edge of INT_CLK_ERR_RAW since last INT_CLK_ERR_CLR
CLK_RECO VER_FLAG	2	–	PCM input clock error recovery event maskable interrupt flag. Masked by CLK_RECOVER_EN and cleared by CLK_RECOVER_CLR. If IRQ is enabled, an interrupt is generated on a flag bit rising edge.	0: No rising edge of CLK_RECOVER_RAW since last CLK_RECOVER_CLR or CLK_RECOVER_EN is low 1: BCLK_RECOVER_EN high and rising edge of BCLK_RECOVER_RAW since last BCLK_RECOVER_CLR
CLK_ERR_ FLAG	1	–	PCM input clock error event maskable interrupt flag. Masked by CLK_ERR_EN and cleared by CLK_ERR_CLR. If IRQ is enabled, an interrupt is generated on a flag bit rising edge.	0: No rising edge of CLK_ERR_RAW since last CLK_ERR_CLR or CLK_ERR_EN is low 1: CLK_ERR_EN high and rising edge of CLK_ERR_RAW since last CLK_ERR_CLR

BITFIELD	BITS	RES	DESCRIPTION	DECODE
DMON_ERR_FLAG	0	–	PCM data input error event maskable interrupt flag. Masked by DMON_ERR_EN and cleared by DMON_ERR_CLR. If IRQ is enabled, an interrupt is generated on a flag bit rising edge.	0: No rising edge of DMON_ERR_RAW since last DMON_ERR_CLR or DMON_ERR_EN is low 1: DMON_ERR_EN high and rising edge of DMON_ERR_RAW since last DMON_ERR_CLR

**Interrupt Flag 3 (0x200D)**

BIT	7	6	5	4	3	2	1	0
Field	–	–	PWRUP_DONE_FLAG	PWRDN_DONE_FLAG	PVDD_UVLO_SHDN_FLAG	VBAT_UVLO_SHDN_FLAG	DHT_ACTIVE_BGN_FLAG	DHT_ACTIVE_END_FLAG
Reset	–	–	0b0	0b0	0b0	0b0	0b0	0b0
Access Type	–	–	Read Only	Read Only	Read Only	Read Only	Read Only	Read Only

BITFIELD	BITS	RES	DESCRIPTION	DECODE
PWRUP_DONE_FLAG	5	–	Device power-up done event maskable interrupt flag. Masked by PWRUP_DONE_EN and cleared by PWRUP_DONE_CLR. If IRQ is enabled, an interrupt is generated on a flag bit rising edge.	0: No rising edge of PWRUP_DONE_RAW since last PWRUP_DONE_CLR or PWRUP_DONE_EN is low 1: PWRUP_DONE_EN is high and rising edge of PWRUP_DONE_RAW since last PWRUP_DONE_CLR
PWRDN_DONE_FLAG	4	–	Device power-down done event maskable interrupt flag. Masked by PWRDN_DONE_EN and cleared by PWRDN_DONE_CLR. If IRQ is enabled, an interrupt is generated on a flag bit rising edge.	0: No rising edge of PWRDN_DONE_RAW since last PWRDN_DONE_CLR or PWRDN_DONE_EN is low 1: PWRDN_DONE_EN is high and rising edge of PWRDN_DONE_RAW since last PWRDN_DONE_CLR
PVDD_UVLO_SHDN_FLAG	3	–	PVDD supply UVLO event maskable interrupt flag. Masked by PVDD_UVLO_SHDN_EN and cleared by PVDD_UVLO_SHDN_CLR. If IRQ is enabled, an interrupt is generated on a flag bit rising edge.	0: No rising edge of PVDD_UVLO_SHDN_RAW since last PVDD_UVLO_SHDN_CLR or PVDD_UVLO_SHDN_EN is low 1: PVDD_UVLO_SHDN_EN is high and rising edge of PVDD_UVLO_SHDN_RAW since last PVDD_UVLO_SHDN_CLR
VBAT_UVLO_SHDN_FLAG	2	–	VBAT supply UVLO event maskable interrupt flag. Masked by VBAT_UVLO_SHDN_EN and cleared by VBAT_UVLO_SHDN_CLR. If IRQ is enabled, an interrupt is generated on a flag bit rising edge.	0: No rising edge of VBAT_UVLO_SHDN_RAW since last VBAT_UVLO_SHDN_CLR or VBAT_UVLO_SHDN_EN is low 1: VBAT_UVLO_SHDN_EN is high and rising edge of VBAT_UVLO_SHDN_RAW since last VBAT_UVLO_SHDN_CLR
DHT_ACTIVE_BGN_FLAG	1	–	DHT active begin event maskable interrupt flag. Masked by DHT_ACTIVE_BGN_EN and cleared by DHT_ACTIVE_BGN_CLR. If IRQ is enabled, an interrupt is generated on a flag bit rising edge.	0: No rising edge of DHT_ACTIVE_BGN_RAW since last DHT_ACTIVE_BGN_CLR or DHT_ACTIVE_BGN_EN is low 1: DHT_ACTIVE_BGN_EN is high and rising edge of DHT_ACTIVE_BGN_RAW since last DHT_ACTIVE_BGN_CLR



BITFIELD	BITS	RES	DESCRIPTION	DECODE
DHT_ACTIVE_END_FLAG	0	–	DHT active end event maskable interrupt flag. Masked by DHT_ACTIVE_END_EN and cleared by DHT_ACTIVE_END_CLR. If IRQ is enabled, an interrupt is generated on a flag bit rising edge.	0: No rising edge of DHT_ACTIVE_END_RAW since last DHT_ACTIVE_END_CLR or DHT_ACTIVE_END_EN is low 1: DHT_ACTIVE_END_EN is high and rising edge of DHT_ACTIVE_END_RAW since last DHT_ACTIVE_END_CLR

#### Interrupt Flag 4 (0x200E)

BIT	7	6	5	4	3	2	1	0
Field	–	–	–	–	BPE_L0_FLAG	BPE_LEVEL_FLAG	BPE_ACTIVE_BGN_FLAG	BPE_ACTIVE_END_FLAG
Reset	–	–	–	–	0x0	0x0	0x0	0x0
Access Type	–	–	–	–	Read Only	Read Only	Read Only	Read Only

BITFIELD	BITS	RES	DESCRIPTION	DECODE
BPE_L0_FLAG	3	–	Brownout-prevention engine level 0 entry event maskable interrupt flag. Masked by BPE_L0_EN and cleared by BPE_L0_CLR. If IRQ is enabled, an interrupt is generated on a flag bit rising edge.	0: No rising edge of BPE_L0_RAW since last BPE_L0_CLR or BPE_L0_EN is low 1: BPE_L0_EN high and rising edge of BPE_L0_RAW since last BPE_L0_CLR
BPE_LEVEL_FLAG	2	–	Brownout-prevention engine level change maskable interrupt flag. Masked by BPE_LEVEL_EN and cleared by BPE_LEVEL_CLR. If IRQ is enabled, an interrupt is generated on a flag bit rising edge.	0: No rising edge of BPE_LEVEL_RAW since last BPE_LEVEL_CLR or BPE_LEVEL_EN is low 1: BPE_LEVEL_EN high and rising edge of BPE_LEVEL_RAW since last BPE_LEVEL_CLR
BPE_ACTIVE_BGN_FLAG	1	–	Brownout-prevention engine active end maskable interrupt flag. Masked by BPE_ACTIVE_BGN_EN and cleared by BPE_ACTIVE_BGN_CLR. If IRQ is enabled, an interrupt is generated on a flag bit rising edge.	0: No rising edge of BPE_ACTIVE_BGN_RAW since last BPE_ACTIVE_BGN_CLR or BPE_ACTIVE_BGN_EN is low 1: BPE_ACTIVE_BGN_EN high and rising edge of BPE_ACTIVE_BGN_RAW since last BPE_ACTIVE_BGN_CLR
BPE_ACTIVE_END_FLAG	0	–	Brownout-prevention engine active end maskable interrupt flag. Masked by BPE_ACTIVE_END_EN and cleared by BPE_ACTIVE_END_CLR. If IRQ is enabled, an interrupt is generated on a flag bit rising edge.	0: No rising edge of BPE_ACTIVE_END_RAW since last BPE_ACTIVE_END_CLR or BPE_ACTIVE_END_EN is low 1: BPE_ACTIVE_END_EN high and rising edge of BPE_ACTIVE_END_RAW since last BPE_ACTIVE_END_CLR

Interrupt Enable 1 (0x2010)

BIT	7	6	5	4	3	2	1	0
Field	THERMSH DN_BGN_E N	THERMSH DN_END_E N	THERMWA RN1_BGN_ EN	THERMWA RN1_END_ EN	THERMFB_ BGN_EN	THERMFB_ END_EN	OTP_FAIL_ EN	SPK_OVC_ EN
Reset	0b0	0b0	0b0	0b0	0b0	0b0	0b1	0b0
Access Type	Write, Read	Write, Read	Write, Read	Write, Read	Write, Read	Write, Read	Write, Read	Write, Read

BITFIELD	BITS	RES	DESCRIPTION	DECODE
THERMSH DN_BGN_E N	7	–	Enable (unmask) control for THERMSHDN_BGN_FLAG.	0: THERMSHDN_BGN_FLAG cannot go high 1: THERMSHDN_BGN_FLAG goes high if there is a rising edge on THERMSHDN_BGN_RAW since last THERMSHDN_BGN_CLR.
THERMSH DN_END_E N	6	–	Enable (unmask) control for THERMSHDN_END_FLAG.	0: THERMSHDN_END_FLAG cannot go high 1: THERMSHDN_END_FLAG goes high if there is a rising edge on THERMSHDN_END_RAW since last THERMSHDN_END_CLR.
THERMWA RN1_BGN_ EN	5	–	Enable (unmask) control for THERMWARIN1_BGN_FLAG.	0: THERMWARIN1_BGN_FLAG cannot go high 1: THERMWARIN1_BGN_FLAG goes high if there is a rising edge on THERMWARIN1_BGN_RAW since last THERMWARIN1_BGN_CLR.
THERMWA RN1_END_ EN	4	–	Enable (unmask) control for THERMWARIN1_END_FLAG.	0: THERMWARIN1_END_FLAG cannot go high 1: THERMWARIN1_END_FLAG goes high if there is a rising edge on THERMWARIN1_END_RAW since last THERMWARIN1_END_CLR.
THERMFB_ BGN_EN	3	–	Enable (unmask) control for THERMFB_BGN_FLAG.	0: THERMFB_BGN_FLAG cannot go high 1: THERMFB_BGN_FLAG goes high if there is a rising edge on THERMFB_BGN_RAW since last THERMFB_BGN_CLR.
THERMFB_ END_EN	2	–	Enable (unmask) control for THERMFB_END_FLAG.	0: THERMFB_END_FLAG cannot go high 1: THERMFB_END_FLAG goes high if there is a rising edge on THERMFB_END_RAW since last THERMFB_END_CLR.
OTP_FAIL_ EN	1	–	Enable (unmask) control for OTP_FAIL_FLAG.	0: OTP_FAIL_FLAG cannot go high 1: OTP_FAIL_FLAG goes high if there is a rising edge on OTP_FAIL_RAW since last OTP_FAIL_CLR.
SPK_OVC_ EN	0	–	Enable (unmask) control for SPK_OVC_FLAG.	0: SPK_OVC_FLAG cannot go high 1: SPK_OVC_FLAG goes high if there is a rising edge on SPK_OVC_RAW since last SPK_OVC_CLR.

Interrupt Enable 2 (0x2011)

BIT	7	6	5	4	3	2	1	0
Field	THERMWAR N2_BGN_ EN	THERMWAR N2_END_ EN	INT_SPKM ON_ERR_E N	INT_CLK_E RR_EN	–	CLK_RECO VER_EN	CLK_ERR_ EN	DMON_ER R_EN
Reset	0b0	0b0	0b0	0x0	–	0x0	0x0	0b0
Access Type	Write, Read	Write, Read	Write, Read	Write, Read	–	Write, Read	Write, Read	Write, Read

BITFIELD	BITS	RES	DESCRIPTION	DECODE
THERMWAR N2_BGN_ EN	7	–	Enable (unmask) control for THERMWAR N2_BGN_FLAG.	0: THERMWAR N2_BGN_FLAG cannot go high 1: THERMWAR N2_BGN_FLAG goes high if there is a rising edge on THERMWAR N2_BGN_RAW since last THERMWAR N2_BGN_CLR.
THERMWAR N2_END_ EN	6	–	Enable (unmask) control for THERMWAR N2_END_FLAG.	0: THERMWAR N2_END_FLAG cannot go high 1: THERMWAR N2_END_FLAG goes high if there is a rising edge on THERMWAR N2_END_RAW since last THERMWAR N2_END_CLR.
INT_SPKM ON_ERR_E N	5	–	Enable (unmask) control for INT_SPKM ON_ERR_FLAG.	0: INT_SPKM ON_ERR_FLAG cannot go high 1: INT_SPKM ON_ERR_FLAG goes high if there is a rising edge on INT_SPKM ON_ERR_RAW since last INT_SPKM ON_ERR_CLR.
INT_CLK_E RR_EN	4	–	Enable (unmask) control for INT_CLK_E RR_FLAG.	0: INT_CLK_E RR_FLAG cannot go high 1: INT_CLK_E RR_FLAG goes high if there is a rising edge on INT_CLK_E RR_RAW since last INT_CLK_E RR_CLR.
CLK_RECO VER_EN	2	–	Enable (unmask) control for CLK_RECO VER_FLAG.	0: CLK_RECO VER_FLAG cannot go high 1: CLK_RECO VER_FLAG goes high if there is a rising edge on CLK_RECO VER_RAW since last CLK_RECO VER_CLR.
CLK_ERR_ EN	1	–	Enable (unmask) control for CLK_ERR_ EN_FLAG.	0: CLK_ERR_ EN_FLAG cannot go high 1: CLK_ERR_ EN_FLAG goes high if there is a rising edge on CLK_ERR_ EN_RAW since last CLK_ERR_ EN_CLR.
DMON_ER R_EN	0	–	Enable (unmask) control for DMON_ER R_FLAG.	0: DMON_ER R_FLAG cannot go high 1: DMON_ER R_FLAG goes high if there is a rising edge on DMON_ER R_RAW since last DMON_ER R_CLR.

Interrupt Enable 3 (0x2012)

BIT	7	6	5	4	3	2	1	0
Field	–	–	PWRUP_D ONE_EN	PWRDN_D ONE_EN	PVDD_UVL O_SHDN_E N	VBAT_UVL O_SHDN_E N	DHT_ACTI VE_BGN_E N	DHT_ACTI VE_END_E N
Reset	–	–	0b0	0b0	0b0	0b0	0b0	0b0
Access Type	–	–	Write, Read	Write, Read	Write, Read	Write, Read	Write, Read	Write, Read

BITFIELD	BITS	RES	DESCRIPTION	DECODE
PWRUP_D ONE_EN	5	–	Enable (unmask) control for PWRUP_DONE_FLAG.	0: PWRUP_DONE_FLAG cannot go high 1: PWRUP_DONE_FLAG goes high if there is a rising edge on PWRUP_DONE_RAW since last PWRUP_DONE_CLR.
PWRDN_D ONE_EN	4	–	Enable (unmask) control for PWRDN_DONE_FLAG.	0: PWRDN_DONE_FLAG cannot go high 1: PWRDN_DONE_FLAG goes high if there is a rising edge on PWRDN_DONE_RAW since last PWRDN_DONE_CLR.
PVDD_UVL O_SHDN_E N	3	–	Enable (unmask) control for PVDD_UVLO_SHDN_FLAG.	0: PVDD_UVLO_SHDN_FLAG cannot go high 1: PVDD_UVLO_SHDN_FLAG goes high if there is a rising edge on PVDD_UVLO_SHDN_RAW since last PVDD_UVLO_SHDN_CLR.
VBAT_UVL O_SHDN_E N	2	–	Enable (unmask) control for VBAT_UVLO_SHDN_FLAG.	0: VBAT_UVLO_SHDN_FLAG cannot go high 1: VBAT_UVLO_SHDN_FLAG goes high if there is a rising edge on VBAT_UVLO_SHDN_RAW since last VBAT_UVLO_SHDN_CLR.
DHT_ACTI VE_BGN_E N	1	–	Enable (unmask) control for DHT_ACTIVE_BGN_FLAG.	0: DHT_ACTIVE_BGN_FLAG cannot go high 1: DHT_ACTIVE_BGN_FLAG goes high if there is a rising edge on DHT_ACTIVE_BGN_RAW since last DHT_ACTIVE_BGN_CLR.
DHT_ACTI VE_END_E N	0	–	Enable (unmask) control for DHT_ACTIVE_END_FLAG.	0: DHT_ACTIVE_END_FLAG cannot go high 1: DHT_ACTIVE_END_FLAG goes high if there is a rising edge on DHT_ACTIVE_END_RAW since last DHT_ACTIVE_END_CLR.

Interrupt Enable 4 (0x2013)

BIT	7	6	5	4	3	2	1	0
Field	–	–	–	–	BPE_L0_EN	BPE_LEVEL_EN	BPE_ACTIVE_BGN_EN	BPE_ACTIVE_END_EN
Reset	–	–	–	–	0x0	0x0	0x0	0x0
Access Type	–	–	–	–	Write, Read	Write, Read	Write, Read	Write, Read

BITFIELD	BITS	RES	DESCRIPTION	DECODE
BPE_L0_EN	3	–	Enable (unmask) control for BPE_L0_FLAG.	0: BPE_L0_FLAG cannot go high 1: BPE_L0_FLAG goes high if there is a rising edge on BPE_L0_RAW since last BPE_L0_CLR.
BPE_LEVEL_EN	2	–	Enable (unmask) control for BPE_LEVEL_FLAG.	0: BPE_LEVEL_FLAG cannot go high 1: BPE_LEVEL_FLAG goes high if there is a rising edge on BPE_LEVEL_RAW since last BPE_LEVEL_CLR.
BPE_ACTIVE_BGN_EN	1	–	Enable (unmask) control for BPE_ACTIVE_BGN_FLAG.	0: BPE_ACTIVE_BGN_FLAG cannot go high 1: BPE_ACTIVE_BGN_FLAG goes high if there is a rising edge on BPE_ACTIVE_BGN_RAW since last BPE_ACTIVE_BGN_CLR.
BPE_ACTIVE_END_EN	0	–	Enable (unmask) control for BPE_ACTIVE_END_FLAG.	0: BPE_ACTIVE_END_FLAG cannot go high 1: BPE_ACTIVE_END_FLAG goes high if there is a rising edge on BPE_ACTIVE_END_RAW since last BPE_ACTIVE_END_CLR.

Interrupt Flag Clear 1 (0x2015)

BIT	7	6	5	4	3	2	1	0
Field	THERMSHDN_BGN_CLR	THERMSHDN_END_CLR	THERMWARN1_BGN_CLR	THERMWARN1_END_CLR	THERMFB_BGN_CLR	THERMFB_END_CLR	OTP_FAIL_CLR	SPK_OVC_CLR
Reset	0b0	0b0	0b0	0b0	0b0	0b0	0b0	0b0
Access Type	Write Only	Write Only	Write Only	Write Only	Write Only	Write Only	Write Only	Write Only

BITFIELD	BITS	RES	DESCRIPTION	DECODE
THERMSHDN_BGN_CLR	7	–	Clears associated FLAG and STATE bits.	0: Writing zero has no effect 1: Writing one clears THERMSHDN_BGN_STATE and THERMSHDN_BGN_FLAG to zero
THERMSHDN_END_CLR	6	–	Clears associated FLAG and STATE bits.	0: Writing zero has no effect 1: Writing one clears THERMSHDN_END_STATE and THERMSHDN_END_FLAG to zero

BITFIELD	BITS	RES	DESCRIPTION	DECODE
THERMWAR N1_BGN_ CLR	5	–	Clears associated FLAG and STATE bits.	0: Writing zero has no effect 1: Writing one clears THERMWAR N1_BGN_STATE and THERMWAR N1_BGN_FLAG to zero
THERMWAR N1_END_ CLR	4	–	Clears associated FLAG and STATE bits.	0: Writing zero has no effect 1: Writing one clears THERMWAR N1_END_STATE and THERMWAR N1_END_FLAG to zero
THERMFB_ BGN_CLR	3	–	Clears associated FLAG and STATE bits.	0: Writing zero has no effect 1: Writing one clears THERMFB_BGN_STATE and THERMFB_BGN_FLAG to zero
THERMFB_ END_CLR	2	–	Clears associated FLAG and STATE bits.	0: Writing zero has no effect 1: Writing one clears THERMFB_END_STATE and THERMFB_END_FLAG to zero
OTP_FAIL_ CLR	1	–	Clears associated FLAG and STATE bits.	0: Writing zero has no effect 1: Writing one clears OTP_FAIL_STATE and OTP_FAIL_FLAG to zero
SPK_OVC_ CLR	0	–	Clears associated FLAG and STATE bits.	0: Writing zero has no effect 1: Writing one clears SPK_OVC_STATE and SPK_OVC_FLAG to zero

**Interrupt Flag Clear 2 (0x2016)**

BIT	7	6	5	4	3	2	1	0
<b>Field</b>	THERMWA RN2_BGN_ CLR	THERMWA RN2_END_ CLR	INT_SPKM ON_ERR_C LR	INT_CLK_E RR_CLR	–	CLK_RECO VER_CLR	CLK_ERR_ CLR	DMON_ER R_CLR
<b>Reset</b>	0b0	0b0	0b0	0x0	–	0x0	0x0	0b0
<b>Access Type</b>	Write Only	Write Only	Write Only	Write Only	–	Write Only	Write Only	Write Only

BITFIELD	BITS	RES	DESCRIPTION	DECODE
THERMWA RN2_BGN_ CLR	7	–	Clears associated FLAG and STATE bits.	0: Writing zero has no effect 1: Writing one clears THERMWAR N2_BGN_STATE and THERMWAR N2_BGN_FLAG to zero
THERMWA RN2_END_ CLR	6	–	Clears associated FLAG and STATE bits.	0: Writing zero has no effect 1: Writing one clears THERMWAR N2_END_STATE and THERMWAR N2_END_FLAG to zero
INT_SPKM ON_ERR_C LR	5	–	Clears associated FLAG and STATE bits.	0: Writing zero has no effect 1: Writing one clears INT_SPKMON_ERR_STATE and INT_SPKMON_ERR_FLAG to zero
INT_CLK_E RR_CLR	4	–	Clears associated FLAG and STATE bits.	0: Writing zero has no effect 1: Writing one clears INT_CLK_ERR_STATE and INT_CLK_ERR_FLAG to zero

BITFIELD	BITS	RES	DESCRIPTION	DECODE
CLK_RECOVER_CLR	2	–	Clears associated FLAG and STATE bits.	0: Writing zero has no effect 1: Writing one clears CLK_RECOVER_STATE and CLK_RECOVER_FLAG to zero
CLK_ERR_CLR	1	–	Clears associated FLAG and STATE bits.	0: Writing zero has no effect 1: Writing one clears CLK_ERR_STATE and CLK_ERR_FLAG to zero
DMON_ERR_CLR	0	–	Clears associated FLAG and STATE bits.	0: Writing zero has no effect 1: Writing one clears DMON_ERR_STATE and DMON_ERR_FLAG to zero

**Interrupt Flag Clear 3 (0x2017)**

BIT	7	6	5	4	3	2	1	0
Field	–	–	PWRUP_DONE_CLR	PWRDN_DONE_CLR	PVDD_UVLO_SHDN_CLR	VBAT_UVLO_SHDN_CLR	DHT_ACTIVE_BGN_CLR	DHT_ACTIVE_END_CLR
Reset	–	–	0b0	0b0	0b0	0b0	0b0	0b0
Access Type	–	–	Write Only	Write Only	Write Only	Write Only	Write Only	Write Only

BITFIELD	BITS	RES	DESCRIPTION	DECODE
PWRUP_DONE_CLR	5	–	Clears associated FLAG and STATE bits.	0: Writing zero has no effect 1: Writing one clears PWRUP_DONE_STATE and PWRUP_DONE_FLAG to zero
PWRDN_DONE_CLR	4	–	Clears associated FLAG and STATE bits.	0: Writing zero has no effect 1: Writing one clears PWRDN_DONE_STATE and PWRDN_DONE_FLAG to zero
PVDD_UVLO_SHDN_CLR	3	–	Clears associated FLAG and STATE bits.	0: Writing zero has no effect 1: Writing one clears PVDD_UVLO_SHDN_STATE and PVDD_UVLO_SHDN_FLAG to zero
VBAT_UVLO_SHDN_CLR	2	–	Clears associated FLAG and STATE bits.	0: Writing zero has no effect 1: Writing one clears VBAT_UVLO_SHDN_STATE and VBAT_UVLO_SHDN_FLAG to zero
DHT_ACTIVE_BGN_CLR	1	–	Clears associated FLAG and STATE bits.	0: Writing zero has no effect 1: Writing one clears DHT_ACTIVE_BGN_STATE and DHT_ACTIVE_BGN_FLAG to zero
DHT_ACTIVE_END_CLR	0	–	Clears associated FLAG and STATE bits.	0: Writing zero has no effect 1: Writing one clears DHT_ACTIVE_END_STATE and DHT_ACTIVE_END_FLAG to zero

Interrupt Flag Clear 4 (0x2018)

BIT	7	6	5	4	3	2	1	0
Field	–	–	–	–	BPE_L0_CLR	BPE_LEVEL_CLR	BPE_ACTIVE_BGN_CLR	BPE_ACTIVE_END_CLR
Reset	–	–	–	–	0x0	0x0	0x0	0x0
Access Type	–	–	–	–	Write Only	Write Only	Write Only	Write Only

BITFIELD	BITS	RES	DESCRIPTION	DECODE
BPE_L0_CLR	3	–	Clears associated FLAG and STATE bits.	0: Writing zero has no effect 1: Writing one clears BPE_L0_STATE and BPE_L0_FLAG to zero
BPE_LEVEL_CLR	2	–	Clears associated FLAG and STATE bits.	0: Writing zero has no effect 1: Writing one clears BPE_LEVEL_STATE and BPE_LEVEL_FLAG to zero
BPE_ACTIVE_BGN_CLR	1	–	Clears associated FLAG and STATE bits.	0: Writing zero has no effect 1: Writing one clears BPE_ACTIVE_BGN_STATE and BPE_ACTIVE_BGN_FLAG to zero
BPE_ACTIVE_END_CLR	0	–	Clears associated FLAG and STATE bits.	0: Writing zero has no effect 1: Writing one clears BPE_ACTIVE_END_STATE and BPE_ACTIVE_END_FLAG to zero

IRQ Control (0x201F)

BIT	7	6	5	4	3	2	1	0
Field	–	–	–	–	–	IRQ_MODE	IRQ_POL	IRQ_EN
Reset	–	–	–	–	–	0b0	0b0	0b0
Access Type	–	–	–	–	–	Write, Read	Write, Read	Write, Read

BITFIELD	BITS	RES	DESCRIPTION	DECODE
IRQ_MODE	2	IRQ	Controls the drive mode of the IRQ output.	0: Open-drain output (an external pullup resistor is required) 1: CMOS push-pull output
IRQ_POL	1	IRQ	Controls the IRQ output assert polarity.	0: IRQ output is low when any interrupt FLAG bits are high (i.e., active-low) 1: IRQ output is high when any interrupt FLAG bits are high (i.e., active-high)
IRQ_EN	0	–	Enables the IRQ Output.	0: IRQ output is disabled and is Hi-Z 1: IRQ output is enabled and controlled by the interrupt controller



Thermal Warning Threshold (0x2020)

BIT	7	6	5	4	3	2	1	0
<b>Field</b>	–	THERMWARN1_THRESH[6:0]						
<b>Reset</b>	–	0x46						
<b>Access Type</b>	–	Write, Read						
BITFIELD	BITS	RES	DESCRIPTION			DECODE		
THERMWARN1_THRESHOLD	6:0	EN	Sets the first thermal-warning threshold temperature.			0x00: 50°C 0x01: 51°C 0x02: 52°C ... .. 0x62: 148°C 0x63: 149°C 0x64-0x7F: 150°C		

Warning Threshold 2 (0x2021)

BIT	7	6	5	4	3	2	1	0
<b>Field</b>	–	THERMWARN2_THRESH[6:0]						
<b>Reset</b>	–	0x46						
<b>Access Type</b>	–	Write, Read						
BITFIELD	BITS	RES	DESCRIPTION			DECODE		
THERMWARN2_THRESHOLD	6:0	EN	Sets the second thermal-warning threshold temperature.			0x00: 50°C 0x01: 51°C 0x02: 52°C ... .. 0x62: 148°C 0x63: 149°C 0x64-0x7F: 150°C		

Thermal Shutdown Threshold (0x2022)

BIT	7	6	5	4	3	2	1	0
<b>Field</b>	–	THERMSHDN_THRESHOLD[6:0]						
<b>Reset</b>	–	0x64						
<b>Access Type</b>	–	Write, Read						
BITFIELD	BITS	RES	DESCRIPTION			DECODE		
THERMSHDN_THRESHOLD	6:0	EN	Sets the thermal-shutdown threshold temperature.			0x00: 50°C 0x01: 51°C 0x02: 52°C ... .. 0x30: 98°C 0x31: 99°C 0x64 to 0x7F: 150°C		

Thermal Hysteresis (0x2023)

BIT	7	6	5	4	3	2	1	0
Field	–	–	–	–	–	–	THERM_HYST[1:0]	
Reset	–	–	–	–	–	–	0x2	
Access Type	–	–	–	–	–	–	Write, Read	

BITFIELD	BITS	RES	DESCRIPTION	DECODE
THERM_HYST	1:0	EN	Controls the amount of hysteresis applied to the thermal threshold measurements.	0x0: 2°C 0x1: 5°C 0x2: 7°C 0x3: 10°C

Thermal Foldback Settings (0x2024)

BIT	7	6	5	4	3	2	1	0
Field	THERMFB_HOLD[1:0]		THERMFB_RLS[1:0]		THERMFB_SLOPE2[1:0]		THERMFB_SLOPE1[1:0]	
Reset	0x3		0x0		0x1		0x1	
Access Type	Write, Read		Write, Read		Write, Read		Write, Read	

BITFIELD	BITS	RES	DESCRIPTION	DECODE
THERMFB_HOLD	7:6	TFB	The thermal foldback hold time controls how long the device temperature must remain below the configured thermal threshold hysteresis before thermal foldback release begins.	0x0: 0ms 0x1: 20ms 0x2: 40ms 0x3: 80ms
THERMFB_RLS	5:4	TFB	This sets the release rate of the thermal foldback attenuation.	0x0: 3ms/dB 0x1: 10ms/dB 0x2: 100ms/dB 0x3: 300ms/dB
THERMFB_SLOPE2	3:2	TFB	This sets the slope of the thermal foldback attenuation when die temperature exceeds THERMWARN2_THRESH.	0x0: 0.25dB/°C 0x1: 0.5dB/°C 0x2: 1.0dB/°C 0x3: 2.0dB/°C
THERMFB_SLOPE1	1:0	TFB	This sets the slope of the thermal foldback attenuation when die temperature exceeds thermal-warning1 threshold (THERMWARN1_THRESH) but is lower than thermal-warning2 threshold (THERMWARN2_THRESH).	0x0: 0.25dB/°C 0x1: 0.5dB/°C 0x2: 1.0dB/°C 0x3: 2.0dB/°C

**Thermal Foldback Enable (0x2027)**

BIT	7	6	5	4	3	2	1	0
Field	–	–	–	–	–	–	–	THERMFB_EN
Reset	–	–	–	–	–	–	–	0b1
Access Type	–	–	–	–	–	–	–	Write, Read

BITFIELD	BITS	RES	DESCRIPTION	DECODE
THERMFB_EN	0	–	Enables Thermal Foldback.	0: Thermal foldback disabled 1: Thermal foldback enabled

**Noise Gate/Idle Mode Control (0x2030)**

BIT	7	6	5	4	3	2	1	0
Field	UNMUTE_THRESH[3:0]				MUTE_THRESH[3:0]			
Reset	0x3				0x2			
Access Type	Write, Read				Write, Read			

BITFIELD	BITS	RES	DESCRIPTION	DECODE
UNMUTE_THRESH	7:4	NG	Sets the threshold (number of LSBs toggling) at which the noise gate/idle mode deactivates.	0x0: 1 LSB 0x1: 2 LSBs 0x2: 3 LSBs 0x3: 4 LSBs 0x4: 5 LSBs 0x5: 6 LSBs 0x6: 7 LSBs 0x7: 8 LSBs 0x8: 9 LSBs 0x9: 10 LSBs 0xA to 0xF: Reserved
MUTE_THRESHOLD	3:0	NG	Sets the threshold (number of LSBs toggling) at which the noise gate/idle mode is activated.	0x0: 1 LSB 0x1: 2 LSBs 0x2: 3 LSBs 0x3: 4 LSBs 0x4: 5 LSBs 0x5: 6 LSBs 0x6: 7 LSBs 0x7: 8 LSBs 0x8: 9 LSBs 0x9: 10 LSBs 0xA to 0xF: Reserved

**Noise Gate/Idle Mode Enables (0x2033)**

BIT	7	6	5	4	3	2	1	0
Field	–	–	–	–	–	–	–	NOISEGAT E_EN
Reset	–	–	–	–	–	–	–	0x0
Access Type	–	–	–	–	–	–	–	Write, Read

BITFIELD	BITS	RES	DESCRIPTION	DECODE
NOISEGAT E_EN	0	–	Enables the noise gate.	0: Noise gate disabled 1: Noise gate enabled

**Clock Monitor Control (0x2038)**

BIT	7	6	5	4	3	2	1	0
Field	–	CMON_BSELTOL[2:0]			CMON_ERRTOL[2:0]			CMON_AU TORESTAR T_EN
Reset	–	0b0			0x0			0x0
Access Type	–	Write, Read			Write, Read			Write, Read

BITFIELD	BITS	RES	DESCRIPTION	DECODE
CMON_BS ELTOL	6:4	EN	The number of frames of incorrect or correct clock ratio (BCLKs per LRCLK) needed to trigger or recover from a framing error.	0x0: Trigger after 1 incorrect LRCLK frame, recover after 1 correct LRCLK frame 0x1: Trigger after 2 incorrect LRCLK frames, recover after 16 correct LRCLK frames 0x2: Trigger after 3 incorrect LRCLK frames, recover after 24 correct LRCLK frame 0x3: Trigger after 4 incorrect LRCLK frames, recover after 32 correct LRCLK frames 0x4: Trigger after 5 incorrect LRCLK frames, recover after 40 correct LRCLK frames 0x5: Trigger after 6 incorrect LRCLK frames, recover after 48 correct LRCLK frames 0x6: Trigger after 7 incorrect LRCLK frames, recover after 56 correct LRCLK frames 0x7: Trigger after 8 incorrect LRCLK frames, recover after 64 correct LRCLK frames

BITFIELD	BITS	RES	DESCRIPTION	DECODE
CMON_ER RTOL	3:1	EN	Selects the number of incorrect or correct LRCLK periods needed to trigger or recover from a frame clock rate error.	0x0: Trigger after 1 incorrect LRCLK frame, recover after 1 correct LRCLK frame 0x1: Trigger after 2 incorrect LRCLK frames, recover after 16 correct LRCLK frames 0x2: Trigger after 3 incorrect LRCLK frames, recover after 24 correct LRCLK frames 0x3: Trigger after 4 incorrect LRCLK frames, recover after 32 correct LRCLK frames 0x4: Trigger after 5 incorrect LRCLK frames, recover after 40 correct LRCLK frames 0x5: Trigger after 6 incorrect LRCLK frames, recover after 48 correct LRCLK frames 0x6: Trigger after 7 incorrect LRCLK frames, recover after 56 correct LRCLK frames 0x7: Trigger after 8 incorrect LRCLK frames, recover after 64 correct LRCLK frames
CMON_AU TORESTAR T_EN	0	EN	Controls whether or not the device automatically resumes playback when the clocks become valid after the device is disabled due to a clock monitor error.	0: Device does not automatically restart after valid clocks are reapplied. 1: Device automatically restarts after valid clocks are reapplied.

**Data Monitor Control (0x2039)**

BIT	7	6	5	4	3	2	1	0
Field	–	–	DMON_MAG_THRES[1:0]		DMON_STUCK_THRES[1:0]		DMON_DURATION[1:0]	
Reset	–	–	0x0		0x0		0x0	
Access Type	–	–	Write, Read		Write, Read		Write, Read	

BITFIELD	BITS	RES	DESCRIPTION	DECODE
DMON_MA G_THRES	5:4	EN	Sets the data magnitude error threshold that the input PCM amplitude level is compared against. If the input signal is above this threshold for longer than the DMON_DURATION, data monitor error is asserted.	0x0: -30.1030dB (5-bits) 0x1: -24.0824dB (4-bits) 0x2: -18.0618dB (3-bits) 0x3: -12.0412dB (2-bits)
DMON_ST UCK_THRE S	3:2	EN	Sets the data stuck error threshold that the input PCM amplitude level is compared against. If the input signal is stuck at the same value above this threshold for longer than the DMON_DURATION, data monitor error is asserted.	0x0: 15-bits (-90.3090dBFS) 0x1: 13-bits (-78.2678dBFS) 0x2: 11-bits (-66.2266dBFS) 0x3: 9-bits (-54.1854dBFS)

BITFIELD	BITS	RES	DESCRIPTION	DECODE
DMON_DURATION	1:0	EN	Sets the time duration over which the Data Monitor must consecutively detect erroneous input PCM data before asserting a data monitor error.	0x0: 64ms 0x1: 256ms 0x2: 1024ms 0x3: 4096ms

### Speaker Monitor Threshold (0x203A)

BIT	7	6	5	4	3	2	1	0
Field	SPKMON_THRESH[7:0]							
Reset	0d58							
Access Type	Write, Read							

BITFIELD	BITS	RES	DESCRIPTION	DECODE
SPKMON_THRESHOLD	7:0	–	<p>Sets the speaker power threshold. If the signal power recovered by the circuit is above this threshold for longer than the DMON_DURATION, speaker monitor error is asserted. Threshold is calculated as % of <math>f_s</math>. Full-scale means the output voltage hit the rails. The voltage threshold can be calculated from the register setting using the following equation:</p> <p><b>Threshold (voltage) = (SPKMON_THRESH/160) x Active Class-D Supply Voltage</b></p>	Threshold = (SPKMON_THRESH*2)/320

### Speaker Monitor Duration (0x203B)

BIT	7	6	5	4	3	2	1	0
Field	–	–	–	–	SPKMON_DURATION[3:0]			
Reset	–	–	–	–	0x2			
Access Type	–	–	–	–	Write, Read			

BITFIELD	BITS	RES	DESCRIPTION	DECODE
SPKMON_DURATION	3:0	–	Sets the time duration over which the speaker monitor must consecutively detect power above threshold before asserting a speaker monitor error.	<b>Value: Decode</b> 0x0: 10ms 0x1: 25ms 0x2: 50ms 0x3: 75ms 0x4: 100ms 0x5: 200ms 0x6: 300ms 0x7: 400ms 0x8: 500ms 0x9: 600ms 0xA: 700ms 0xB: 800ms 0xC: 900ms 0xD: 1000ms 0xE: 1100ms 0xF: 1200ms

#### Enable Controls (0x203F)

BIT	7	6	5	4	3	2	1	0
Field	–	–	–	–	SPKMON_EN	DMON_MAG_EN	DMON_STUCK_EN	CMON_EN
Reset	–	–	–	–	0x1	0x1	0x1	0x1
Access Type	–	–	–	–	Write, Read	Write, Read	Write, Read	Write, Read

BITFIELD	BITS	RES	DESCRIPTION	DECODE
SPKMON_EN	3	ENL	Enables the internal speaker protection monitor	0x0: Disable internal speaker data monitor 0x1: Enable internal speaker data monitor
DMON_MAG_EN	2	ENL	Enables the data monitor circuit to monitor PCM input data for large magnitude (DC) audio	0: Data magnitude check disabled 1: Data magnitude check enabled
DMON_STUCK_EN	1	ENL	Enables the data monitor circuit to monitor PCM input for stuck data.	0: Data Stuck-AT monitor disabled 1: Data Stuck-AT monitor enabled
CMON_EN	0	ENL	Enables the clock monitor to monitor PCM input clocks for clock errors.	0: Clock monitor disabled 1: Clock monitor enabled

#### Pin Config (0x2040)

BIT	7	6	5	4	3	2	1	0
Field	LV_EN_DRV[1:0]		ICC_DRV[1:0]		IRQ_DRV[1:0]		DOUT_DRV[1:0]	
Reset	0x1		0x1		0x1		0x1	
Access Type	Write, Read		Write, Read		Write, Read		Write, Read	

BITFIELD	BITS	RES	DESCRIPTION	DECODE
LV_EN_DRV	7:6	–	Configures the output drive strength of LV_EN pin.	0x0: Reduced drive mode 0x1: Normal drive mode 0x2: High drive mode 0x3: Maximum drive mode

BITFIELD	BITS	RES	DESCRIPTION	DECODE
ICC_DRV	5:4	ICC	Configures the output drive strength of ICC pin.	00: Reduced drive mode 01: Normal drive mode 10: High drive mode 11: Maximum drive mode
IRQ_DRV	3:2	IRQ	Configures the output drive strength of IRQ pin.	00: Reduced drive mode 01: Normal drive mode 10: High drive mode 11: Maximum drive mode
DOUT_DRV	1:0	TXEN	Configures the output drive strength of DOUT pin.	00: Reduced drive mode 01: Normal drive mode 10: High drive mode 11: Maximum drive mode

### PCM Mode Config (0x2041)

BIT	7	6	5	4	3	2	1	0
Field	PCM_CHANSZ[1:0]		PCM_FORMAT[2:0]			PCM_TX_I NTERLEAV E	PCM_CHA NSEL	PCM_TX_E XTRA_HIZ
Reset	0x3		0x0			0x0	0b0	0b0
Access Type	Write, Read		Write, Read			Write, Read	Write, Read	Write, Read

BITFIELD	BITS	RES	DESCRIPTION	DECODE
PCM_CHAN NSZ	7:6	ENL	Configures the PCM data word size for each channel.	00: Reserved 01: 16-bit 10: 24-bit 11: 32-bit
PCM_FOR MAT	5:3	ENL	Selects the PCM data format.	0x0: I <sup>2</sup> S mode 0x1: Left-justified 0x2: Reserved 0x3: TDM mode 0 (0 BCLK delay from LRCLK) 0x4: TDM mode 1 (1 BCLK delay from LRCLK) 0x5: TDM mode 2 (2 BCLK delay from LRCLK) 0x6 to 0x7: Reserved
PCM_TX_I NTERLEAV E	2	ENL	Controls whether or not I/V sense data assigned to the same channel is frame interleaved on the PCM data output (DOUT).	0: Disable interleave mode 1: Enable interleave mode
PCM_CHA NSEL	1	ENL	Selects which LRCK edge starts a new frame (Channel 0 or Slot 0).	0: I <sup>2</sup> S and left-justified mode: Falling LRCLK edge starts a new frame. In TDM modes: Rising LRCLK edge starts a new frame. 1: In I <sup>2</sup> S and left-justified mode: Rising LRCLK edge starts a new frame. In TDM modes: Falling LRCLK edge starts a new frame.



BITFIELD	BITS	RES	DESCRIPTION	DECODE
PCM_TX_E XTRA_HIZ	0	ENL	Select whether DOUT is driven to zero or Hi-Z during extra BCLK cycles in I <sup>2</sup> S and left-justified mode.	0: Drive DOUT to zero for extra BCLK cycles 1: Drive DOUT to Hi-Z for extra BCLK cycles

### PCM Clock Setup (0x2042)

BIT	7	6	5	4	3	2	1	0
Field	–	–	–	PCM_BCLK EDGE	PCM_BSEL[3:0]			
Reset	–	–	–	0b0	0x4			
Access Type	–	–	–	Write, Read	Write, Read			

BITFIELD	BITS	RES	DESCRIPTION	DECODE
PCM_BCLK EDGE	4	ENL	Selects the active BCLK edge.	0: Input data captured and output data valid on rising edge of BCLK 1: Input data captured and output data valid on falling edge of BCLK
PCM_BSEL	3:0	ENL	Selects the number of BCLKs per LRCLK expected by the PCM Interface.	0x0: Reserved 0x1: Reserved 0x2: 32 0x3: 48 0x4: 64 0x5: 96 0x6: 128 0x7: 192 0x8: 256 0x9: 384 0xA: 512 0xB: 320 0xC: 250 0xD: 125 0xE to 0xF: Reserved

### PCM Sample Rate Setup 1 (0x2043)

BIT	7	6	5	4	3	2	1	0
Field	IVADC_SR[3:0]				PCM_SR[3:0]			
Reset	0x8				0x8			
Access Type	Write, Read				Write, Read			

BITFIELD	BITS	RES	DESCRIPTION	DECODE
IVADC_SR	7:4	ENL	Sets the sample rate of the I/V sense ADC path.	0x0: 8kHz 0x1: 11.025kHz 0x2: 12kHz 0x3: 16kHz 0x4: 22.05kHz 0x5: 24kHz 0x6: 32kHz 0x7: 44.1kHz 0x8: 48kHz 0x9: 88.2kHz 0xA: 96kHz 0xB: 176.4kHz 0xC: 192kHz 0xD to 0xF: Reserved
PCM_SR	3:0	ENL	Sets the sample rate of the PCM interface. This corresponds to the expected LRCLK frequency.	0x0: 8kHz 0x1: 11.025kHz 0x2: 12kHz 0x3: 16kHz 0x4: 22.05kHz 0x5: 24kHz 0x6: 32kHz 0x7: 44.1kHz 0x8: 48kHz 0x9: 88.2kHz 0xA: 96kHz 0xB: 176.4kHz 0xC: 192kHz 0xD to 0xF: Reserved

**PCM TX Control 1 (0x2044)**

BIT	7	6	5	4	3	2	1	0
Field	–	–	PCM_VMON_SLOT[5:0]					
Reset	–	–	0x0					
Access Type	–	–	Write, Read					

BITFIELD	BITS	RES	DESCRIPTION	DECODE
PCM_VMON_SLOT	5:0	TXEN	Selects the data output (DOUT) slots for the voltage sense output data. In non-TDM mode, only Slot 0 and Slot 1 are valid.	0x0: Slot 00/01 0x1: Slot 01/02 0x2: Slot 02/03 0x22 to 0x3D: ... 0x3E: Slot 62/63 0x3F: Reserved

**PCM TX Control 2 (0x2045)**

BIT	7	6	5	4	3	2	1	0
Field	–	–	PCM_IMON_SLOT[5:0]					
Reset	–	–	0x0					
Access Type	–	–	Write, Read					

BITFIELD	BITS	RES	DESCRIPTION	DECODE
PCM_IMON_SLOT	5:0	TXEN	IMON Data Output Slot Select. IMON data requires two slots. In non-TDM mode, only Slot 0 and Slot 1 are valid.	0x0: Slot 00/01 0x1: Slot 01/02 0x2: Slot 02/03 0x22 to 0x3D: ... 0x3E: Slot 62/63 0x3F: Reserved

**PCM TX Control 3 (0x2046)**

BIT	7	6	5	4	3	2	1	0
Field	–	–	PCM_PVDD_SLOT[5:0]					
Reset	–	–	0x0					
Access Type	–	–	Write, Read					

BITFIELD	BITS	RES	DESCRIPTION	DECODE
PCM_PVDD_SLOT	5:0	TXEN	PVDD Data (ADC) Output Slot Select. PVDD data requires two slots.	0x0: Slot 00/01 0x1: Slot 01/02 0x2: Slot 02/03 0x22 to 0x3D: ... 0x3E: Slot 62/63 0x3F: Reserved

**PCM TX Control 4 (0x2047)**

BIT	7	6	5	4	3	2	1	0
Field	–	–	PCM_VBAT_SLOT[5:0]					
Reset	–	–	0x0					
Access Type	–	–	Write, Read					

BITFIELD	BITS	RES	DESCRIPTION	DECODE
PCM_VBAT_SLOT	5:0	TXEN	VBAT Data (ADC) Output Slot Select. VBAT data requires two slots.	0x0: Slot 00/01 0x1: Slot 01/02 0x2: Slot 02/03 0x22 to 0x3D: ... 0x3E: Slot 62/63 0x3F: Reserved

**PCM TX Control 5 (0x2048)**

BIT	7	6	5	4	3	2	1	0
Field	–	–	PCM_DHT_ATN_SLOT[5:0]					
Reset	–	–	0x0					
Access Type	–	–	Write, Read					

BITFIELD	BITS	RES	DESCRIPTION	DECODE
PCM_DHT_ATN_SLOT	5:0	TXEN	DHT Attenuation Data Output Slot Select. DHT attenuation data requires two slots.	0x0: Slot 00/01 0x1: Slot 01/02 0x2: Slot 02/03 0x22 to 0x3D: ... 0x3E: Slot 62/63 0x3F: Reserved

**PCM TX Control 6 (0x2049)**

BIT	7	6	5	4	3	2	1	0
Field	–	–	PCM_STATUS_SLOT[5:0]					
Reset	–	–	0x0					
Access Type	–	–	Write, Read					

BITFIELD	BITS	RES	DESCRIPTION	DECODE
PCM_STAT_US_SLOT	5:0	TXEN	Device Satus Data Output Slot Select. Device status requires two slots.	0x00: Slot 00/01 0x01: Slot 01/02 0x02 to 0x3D: .... 0x3E: Slot 62/63 0x3F: Reserved

**PCM TX Control 7 (0x204A)**

BIT	7	6	5	4	3	2	1	0
Field	–	–	PCM_DSP_MONITOR_SLOT[5:0]					
Reset	–	–	0x0					
Access Type	–	–	Write, Read					

BITFIELD	BITS	RES	DESCRIPTION	DECODE
PCM_DSP_MONITOR_SLOT	5:0	TXEN	DSP Monitor Data Output Slot Select. DSP montior data requires 4 slots.	0x0: Slot 00/01/02/03 0x1: Slot 01/02/03/04 0x2: Slot 02/03/04/05 0x3 to 0x3B: .... 0x3C: Slot 60/61/62/63 0x3D: Reserved 0x3E: Reserved 0x3F: Reserved

**PCM TX Control 8 (0x204B)**

BIT	7	6	5	4	3	2	1	0
Field	–	–	PCM_BPE_SLOT[5:0]					
Reset	–	–	0x0					
Access Type	–	–	Write, Read					

BITFIELD	BITS	RES	DESCRIPTION	DECODE
PCM_BPE_SLOT	5:0	TXEN	BPE State Output Slot Select. BPE state requires one slot.	0x0: Slot 00 0x1: Slot 01 0x2: Slot 02 0x22 to 0x3D: ... 0x3E: Slot 62 0x3F: Slot 62

**PCM Tx HiZ Control 1 (0x204C)**

BIT	7	6	5	4	3	2	1	0
Field	PCM_TX_SLOT_HI_Z[63:56]							
Reset	0xFF							
Access Type	Write, Read							

BITFIELD	BITS	RES	DESCRIPTION	DECODE
PCM_TX_SLOT_HI_Z	7:0	TXEN	Configures the unused PCM data output slots to transmit either Hi-Z or 0.	Value: Decode 0: Output 0 on idle slots from 63 to 56 1: Output Hi-Z on slots from 63 to 56

**PCM Tx HiZ Control 2 (0x204D)**

BIT	7	6	5	4	3	2	1	0
Field	PCM_TX_SLOT_HI_Z[55:48]							
Reset	0xFF							
Access Type	Write, Read							

BITFIELD	BITS	RES	DESCRIPTION	DECODE
PCM_TX_SLOT_HI_Z	7:0	TXEN	Configures the unused PCM slots to set them to Hi-Z or 0.	0: Output 0 on idle slots from 55 to 48 1: Output Hi-Z on slots from 55 to 48

**PCM Tx HiZ Control 3 (0x204E)**

BIT	7	6	5	4	3	2	1	0
Field	PCM_TX_SLOT_HI_Z[47:40]							
Reset	0xFF							
Access Type	Write, Read							

BITFIELD	BITS	RES	DESCRIPTION	DECODE
PCM_TX_SLOT_HI_Z	7:0	TXEN	Configures the unused PCM slots to set them all to Hi-Z or 0.	0: Output 0 on idle slots from 47 to 40 1: Output Hi-Z on slots from 47 to 40

**PCM Tx HiZ Control 4 (0x204F)**

BIT	7	6	5	4	3	2	1	0
<b>Field</b>	PCM_TX_SLOT_HIZ[39:32]							
<b>Reset</b>	0xFF							
<b>Access Type</b>	Write, Read							
BITFIELD	BITS	RES	DESCRIPTION			DECODE		
PCM_TX_SLOT_HIZ	7:0	TXEN	Configures the unused PCM slots to set them all to Hi-Z or 0.			0: Output 0 on idle slots from 39 to 32 1: Output Hi-Z on slots from 39 to 32		

**PCM Tx HiZ Control 5 (0x2050)**

BIT	7	6	5	4	3	2	1	0
<b>Field</b>	PCM_TX_SLOT_HIZ[31:24]							
<b>Reset</b>	0xFF							
<b>Access Type</b>	Write, Read							
BITFIELD	BITS	RES	DESCRIPTION			DECODE		
PCM_TX_SLOT_HIZ	7:0	TXEN	Configures the unused PCM slots to set them all to Hi-Z or 0.			0: Output 0 on slots from 31 to 24 1: Output Hi-Z on idle slots from 31 to 24		

**PCM Tx HiZ Control6 (0x2051)**

BIT	7	6	5	4	3	2	1	0
<b>Field</b>	PCM_TX_SLOT_HIZ[23:16]							
<b>Reset</b>	0xFF							
<b>Access Type</b>	Write, Read							
BITFIELD	BITS	RES	DESCRIPTION			DECODE		
PCM_TX_SLOT_HIZ	7:0	TXEN	Configures the unused PCM slots to set them all to Hi-Z or 0.			0: Output 0 on idle slots from 23 to 16 1: Output Hi-Z on slots from 23 to 16		

**PCM Tx HiZ Control 7 (0x2052)**

BIT	7	6	5	4	3	2	1	0
<b>Field</b>	PCM_TX_SLOT_HIZ[15:8]							
<b>Reset</b>	0xFF							
<b>Access Type</b>	Write, Read							

BITFIELD	BITS	RES	DESCRIPTION	DECODE
PCM_TX_S LOT_HIZ	7:0	TXEN	Configures the unused PCM slots to set them all to Hi-Z or 0.	0: Output 0 on slots from 15 to 8 1: Output Hi-Z on idle slots from 15 to 8

**PCM Tx HiZ Control 8 (0x2053)**

BIT	7	6	5	4	3	2	1	0
Field	PCM_TX_SLOT_HIZ[7:0]							
Reset	0xFF							
Access Type	Write, Read							

BITFIELD	BITS	RES	DESCRIPTION	DECODE
PCM_TX_S LOT_HIZ	7:0	TXEN	Configures the unused PCM slots to set them all to Hi-Z or 0.	0: Output 0 on idle slots from 7 to 0 1: Output Hi-Z on slots from 7 to 0

**PCM RX Source 1 (0x2055)**

BIT	7	6	5	4	3	2	1	0
Field	-	-	-	-	-	-	PCM_DMMIX_CFG[1:0]	
Reset	-	-	-	-	-	-	0x0	
Access Type	-	-	-	-	-	-	Write, Read	

BITFIELD	BITS	RES	DESCRIPTION	DECODE
PCM_DMMI X_CFG	1:0	PCM	Determines the behavior of the mono mixer circuit.	0x0: Output of monomixer is Channel 0 0x1: Output of monomixer is Channel 1 0x2: Output of monomixer is (Channel 0 + Channel1)/2 0x3: Reserved

**PCM RX Source 2 (0x2056)**

BIT	7	6	5	4	3	2	1	0
Field	PCM_DMMIX_CH1_SOURCE[3:0]				PCM_DMMIX_CH0_SOURCE[3:0]			
Reset	0x0				0x0			
Access Type	Write, Read				Write, Read			

BITFIELD	BITS	RES	DESCRIPTION	DECODE
PCM_DMMI X_CH1_SO URCE	7:4	PCM	Selects the PCM data input channel that is routed to the channel 1 of the digital mono mixer.	0x0: PCM Input Channel 0 0x1: PCM Input Channel 1 0x2: PCM Input Channel 2 ..... 0xE: PCM Input Channel 14 0xF: PCM Input Channel 15

BITFIELD	BITS	RES	DESCRIPTION	DECODE
PCM_DMMIX_CH0_SOURCE	3:0	PCM	Selects the PCM data input channel that is routed to the channel 0 of the digital mono mixer.	0x0: PCM Input Channel 0 0x1: PCM Input Channel 1 0x2: PCM Input Channel 2 ... .. 0xE: PCM Input Channel 14 0xF: PCM Input Channel 15

**PCM Bypass Source (0x2058)**

BIT	7	6	5	4	3	2	1	0
Field	-	-	-	-	PCM_BYPASS_SOURCE[3:0]			
Reset	-	-	-	-	0x0			
Access Type	-	-	-	-	Write, Read			

BITFIELD	BITS	RES	DESCRIPTION	DECODE
PCM_BYPASS_SOURCE	3:0	PCM	Selects the PCM data input channel that is routed to the speaker audio processing bypass path.	0x0: PCM Input Channel 0 0x1: PCM Input Channel 1 0x2: PCM Input Channel 2 ... .. 0xE: PCM Input Channel 14 0xF: PCM Input Channel 15

**PCM TX Source Enables (0x205D)**

BIT	7	6	5	4	3	2	1	0
Field	PCM_BPE_EN	PCM_STAT_US_EN	PCM_DHT_ATN_EN	PCM_VBAT_EN	PCM_PVD_D_EN	PCM_DSP_MONITOR_EN	PCM_IMON_EN	PCM_VMON_EN
Reset	0x0	0x0	0x0	0x0	0x0	0x0	0x0	0x0
Access Type	Write, Read	Write, Read	Write, Read	Write, Read	Write, Read	Write, Read	Write, Read	Write, Read

BITFIELD	BITS	RES	DESCRIPTION	DECODE
PCM_BPE_EN	7	TXEN	Enables transmit of the BPE (brownout-prevention engine) state on the assigned data output (DOUT) slot. This output data can be transmitted only in TDM mode.	0: Disable BPE state transmit 1: Enable BPE state transmit
PCM_STAT_US_EN	6	TXEN	Enables transmit of the device status on the assigned data output (DOUT) slots. This output data can be transmitted only in TDM mode.	0: Disable device status transmit 1: Enable device status transmit
PCM_DHT_ATN_EN	5	TXEN	Enables transmit of the applied DHT attenuation on the assigned data output (DOUT) slot. This output data can be transmitted only in TDM mode.	0: Disable DHT attenuation data transmit 1: Enable DHT attenuation data transmit
PCM_VBAT_EN	4	TXEN	Enables transmit of the measured VBAT supply voltage on the assigned data output (DOUT) slot. This output data can be transmitted only in TDM mode.	0: Disable VBAT supply voltage data transmit 1: Enable VBAT supply voltage data transmit



BITFIELD	BITS	RES	DESCRIPTION	DECODE
PCM_PVD D_EN	3	TXEN	Enables transmit of the measured PVDD supply voltage on the assigned data output (DOUT) slot. This output data can be transmitted only in TDM mode.	0: Disable PVDD supply voltage data transmit 1: Enable PVDD supply voltage data transmit
PCM_DSP MONITOR_ EN	2	TXEN	Enables transmit of the playback path DSP output data on the assigned data output (DOUT) slot.	0: Disable playback path data transmit 1: Enable playback path data transmit
PCM_IMON _EN	1	TXEN	Enables transmit of the current sense output data on the assigned data output (DOUT) slot.	0: Disable current sense data transmit 1: Enable current sense data transmit
PCM_VMO N_EN	0	TXEN	Enables transmit of the voltage sense output data on the assigned data output (DOUT) slot.	0: Disable voltage sense data transmit 1: Enable voltage sense data transmit

**PCM Rx Enables (0x205E)**

BIT	7	6	5	4	3	2	1	0
Field	–	–	–	–	–	–	PCM_BYP_ EN	PCM_RX_ E N
Reset	–	–	–	–	–	–		0b0
Access Type	–	–	–	–	–	–	Write, Read	Write, Read

BITFIELD	BITS	RES	DESCRIPTION	DECODE
PCM_BYP_ EN	1	–	Enables the PCM data input to speaker amplifier through the bypass path. This path bypasses the speaker playback path audio processing features like—volume control, gains, DHT, BPE and Thermal Foldback.	0x0: Audio processing bypass path disabled 0x1: Audio processing bypass path enabled
PCM_RX_ E N	0	–	Enables the speaker amplifier playback path.	0: PCM data input disabled 1: PCM data input enabled

**PCM Tx Enables (0x205F)**

BIT	7	6	5	4	3	2	1	0
Field	–	–	–	–	–	–	–	PCM_TX_ E N
Reset	–	–	–	–	–	–	–	0b0
Access Type	–	–	–	–	–	–	–	Write, Read

BITFIELD	BITS	RES	DESCRIPTION	DECODE
PCM_TX_ E N	0	TXEN	Enables the data output (DOUT) of the PCM interface.	0: PCM data output disabled 1: PCM data output enabled

ICC Rx Enables A (0x2070)

BIT	7	6	5	4	3	2	1	0
Field	ICC_RX_C H7_EN	ICC_RX_C H6_EN	ICC_RX_C H5_EN	ICC_RX_C H4_EN	ICC_RX_C H3_EN	ICC_RX_C H2_EN	ICC_RX_C H1_EN	ICC_RX_C H0_EN
Reset	0b0	0b0	0b0	0b0	0b0	0b0	0b0	0b0
Access Type	Write, Read	Write, Read	Write, Read	Write, Read	Write, Read	Write, Read	Write, Read	Write, Read

BITFIELD	BITS	RES	DESCRIPTION	DECODE
ICC_RX_C H7_EN	7	ICC	Configures whether or not the ICC interface accepts data from this channel.	0: ICC receive channel 7 is disabled 1: ICC receive channel 7 is enabled
ICC_RX_C H6_EN	6	ICC	Configures whether or not the ICC interface accepts data from this channel.	0: ICC receive channel 6 is disabled 1: ICC receive channel 6 is enabled
ICC_RX_C H5_EN	5	ICC	Configures whether or not the ICC interface accepts data from this channel.	0: ICC receive channel 5 is disabled 1: ICC receive channel 5 is enabled
ICC_RX_C H4_EN	4	ICC	Configures whether or not the ICC interface accepts data from this channel.	0: ICC receive channel 4 is disabled 1: ICC receive channel 4 is enabled
ICC_RX_C H3_EN	3	ICC	Configures whether or not the ICC interface accepts data from this channel.	0: ICC receive channel 3 is disabled 1: ICC receive channel 3 is enabled
ICC_RX_C H2_EN	2	ICC	Configures whether or not the ICC interface accepts data from this channel.	0: ICC receive channel 2 is disabled 1: ICC receive channel 2 is enabled
ICC_RX_C H1_EN	1	ICC	Configures whether or not the ICC interface accepts data from this channel.	0: ICC receive channel 1 is disabled 1: ICC receive channel 1 is enabled
ICC_RX_C H0_EN	0	ICC	Configures whether or not the ICC interface accepts data from this channel.	0: ICC receive channel 0 is disabled 1: ICC receive channel 0 is enabled

ICC Rx Enables B (0x2071)

BIT	7	6	5	4	3	2	1	0
Field	ICC_RX_C H15_EN	ICC_RX_C H14_EN	ICC_RX_C H13_EN	ICC_RX_C H12_EN	ICC_RX_C H11_EN	ICC_RX_C H10_EN	ICC_RX_C H9_EN	ICC_RX_C H8_EN
Reset	0b0	0b0	0b0	0b0	0b0	0b0	0b0	0b0
Access Type	Write, Read	Write, Read	Write, Read	Write, Read	Write, Read	Write, Read	Write, Read	Write, Read

BITFIELD	BITS	RES	DESCRIPTION	DECODE
ICC_RX_C H15_EN	7	ICC	Configures whether or not the ICC interface accepts data from this channel.	0: ICC receive channel 15 is disabled 1: ICC receive channel 15 is enabled
ICC_RX_C H14_EN	6	ICC	Configures whether or not the ICC interface accepts data from this channel.	0: ICC receive channel 14 is disabled 1: ICC receive channel 14 is enabled
ICC_RX_C H13_EN	5	ICC	Configures whether or not the ICC interface accepts data from this channel.	0: ICC receive channel 13 is disabled 1: ICC receive channel 13 is enabled
ICC_RX_C H12_EN	4	ICC	Configures whether or not the ICC interface accepts data from this channel.	0: ICC receive channel 12 is disabled 1: ICC receive channel 12 is enabled
ICC_RX_C H11_EN	3	ICC	Configures whether or not the ICC interface accepts data from this channel.	0: ICC receive channel 11 is disabled 1: ICC receive channel 11 is enabled
ICC_RX_C H10_EN	2	ICC	Configures whether or not the ICC interface accepts data from this channel.	0: ICC receive channel 10 is disabled 1: ICC receive channel 10 is enabled

BITFIELD	BITS	RES	DESCRIPTION	DECODE
ICC_RX_C H9_EN	1	ICC	Configures whether or not the ICC interface accepts data from this channel.	0: ICC receive channel 9 is disabled 1: ICC receive channel 9 is enabled
ICC_RX_C H8_EN	0	ICC	Configures whether or not the ICC interface accepts data from this channel.	0: ICC receive channel 8 is disabled 1: ICC receive channel 8 is enabled

**ICC Tx Control (0x2072)**

BIT	7	6	5	4	3	2	1	0
Field	–	ICC_INTER LEAVE_MODE	ICC_DATA_SEL	–	ICC_TX_DEST[3:0]			
Reset	–	0x0	0x0	–	0x0			
Access Type	–	Write, Read	Write, Read	–	Write, Read			

BITFIELD	BITS	RES	DESCRIPTION	DECODE
ICC_INTER LEAVE_MODE	6	ICC	Select whether the ICC pin transmits DHT and thermal foldback data in interleaving fashion when PCM data word size (data width) is only 16-bits. This has no effect when the data word size is 24- or 32-bits.	0: ICC transmits either DHT or thermal foldback data based on ICC_DATA_SEL 1: ICC transmits in interleaved mode which DHT and thermal foldback data are sent alternatively
ICC_DATA_SEL	5	ICC	Select whether the ICC pin transmits DHT or thermal foldback data when PCM data word size (data width) is only 16-bits. This has no effect when the data word size is 24- or 32-bits.	0: ICC transmits DHT data + BPE state 1: ICC transmits thermal foldback data + BPE state
ICC_TX_DEST	3:0	ICC	Selects the device transmit channel for ICC data.	0x0: ICC Channel 0 0x1: ICC Channel 1 ...: ... 0xE: ICC Channel 14 0xF: ICC Channel 15

**ICC Enables (0x207F)**

BIT	7	6	5	4	3	2	1	0
Field	–	–	–	–	–	–	ICC_LINK_EN	ICC_TX_EN
Reset	–	–	–	–	–	–	0b0	0x0
Access Type	–	–	–	–	–	–	Write, Read	Write, Read

BITFIELD	BITS	RES	DESCRIPTION	DECODE
ICC_LINK_EN	1	–	Enables ICC link between devices.	0: ICC thermal link disabled 1: ICC thermal link enabled
ICC_TX_EN	0	–	Select whether the ICC pin transmitter is enabled/disabled.	0: ICC transmit disabled 1: ICC transmit enabled

**Tone Generator and DC Config (0x2083)**

BIT	7	6	5	4	3	2	1	0
Field	–	–	TONE_AMPLITUDE[1:0]		TONE_CONFIG[3:0]			
Reset	–	–	0x0		0x4			
Access Type	–	–	Write, Read		Write, Read			

BITFIELD	BITS	RES	DESCRIPTION	DECODE
TONE_AMPLITUDE	5:4	EN	Sets the sine wave amplitude. This register is not used when programming the tone generator to output DC signals.	0x0: -6dBFS 0x1: -4.8dBFS 0x2: 0dBFS 0x3: Reserved
TONE_CONFIG	3:0	EN	Configures the output of the tone generator. For signal outputs, the frequency is a division of the sample rate (fs).	0x0: DC value programmed by TONE_DC[23:0] 0x1: DC = 0x0000 = 0 0x2: DC = +FullScale/2 0x3: DC = -FullScale/2 0x4: 1 KHz tone at all sample rates 0x5: fs/4 0x6: fs/6 0x7 to 0xF: Reserved

**Tone Generator DC Level 1 (0x2084)**

BIT	7	6	5	4	3	2	1	0
Field	TONE_DC[23:16]							
Reset	0x0							
Access Type	Write, Read							

BITFIELD	BITS	RES	DESCRIPTION
TONE_DC	7:0	EN	Sets the tone generator DC output level as a signed binary relative to full-scale.

**Tone Generator DC Level 2 (0x2085)**

BIT	7	6	5	4	3	2	1	0
Field	TONE_DC[15:8]							
Reset	0x0							
Access Type	Write, Read							

BITFIELD	BITS	RES	DESCRIPTION
TONE_DC	7:0	EN	Sets the tone generator DC output level as a signed binary relative to full-scale.

**Tone Generator DC Level 3 (0x2086)**

BIT	7	6	5	4	3	2	1	0
Field	TONE_DC[7:0]							
Reset	0x0							
Access Type	Write, Read							

BITFIELD	BITS	RES	DESCRIPTION
TONE_DC	7:0	EN	Sets the tone generator DC output level as a signed binary relative to full-scale.

**Tone Generator Enable (0x208F)**

BIT	7	6	5	4	3	2	1	0
Field	–	–	–	–	–	–	–	TONE_EN
Reset	–	–	–	–	–	–	–	0b0
Access Type	–	–	–	–	–	–	–	Write, Read

BITFIELD	BITS	RES	DESCRIPTION	DECODE
TONE_EN	0	ENL	Enables the tone generator. When enabled, it replaces the PCM interface as the input to the speaker amplifier path.	0: Tone generator disabled 1: Tone generate enabled

**AMP volume control (0x2090)**

BIT	7	6	5	4	3	2	1	0
Field	–	SPK_VOL[6:0]						
Reset	–	0x0						
Access Type	–	Write, Read						

BITFIELD	BITS	RES	DESCRIPTION	DECODE
SPK_VOL	6:0	–	Sets the digital volume level of the speaker amplifier path.	0x00: 0dB 0x01: -0.5dB 0x02: -1.0dB ...: (-0.5dB steps) 0x7C: -62.0dB 0x7D: -62.5dB 0x7E: -63dB 0x7F: Mute

**AMP Path Gain (0x2091)**

BIT	7	6	5	4	3	2	1	0
Field	–	–	–	SPK_GAIN_MAX[4:0]				
Reset	–	–	–	0xB				
Access Type	–	–	–	Write, Read				

BITFIELD	BITS	RES	DESCRIPTION	DECODE
SPK_GAIN_MAX	4:0	SPK	Sets the maximum peak output voltage level ( $V_{MPO}$ ) for the speaker path (no-load). Values in dB are relative to the baseline speaker path DAC full-scale output level of 3.68dBV.	0x00: 3.43V <sub>P</sub> (4dB) 0x01: 3.84V <sub>P</sub> (5dB) 0x02: 4.31V <sub>P</sub> (5dB) 0x03: 4.84V <sub>P</sub> (7dB) 0x04: 5.43V <sub>P</sub> (8dB) 0x05: 6.09V <sub>P</sub> (9dB) 0x06: 6.84V <sub>P</sub> (10dB) 0x07: 7.67V <sub>P</sub> (11dB) 0x08: 8.61V <sub>P</sub> (12dB) 0x09: 9.66V <sub>P</sub> (13dB) 0x0A: 10.84V <sub>P</sub> (14dB) 0x0B: 12.16V <sub>P</sub> (15dB) 0x0C: 13.64V <sub>P</sub> (16dB) 0x0D: 15.31V <sub>P</sub> (17dB) 0x0E: 17.17V <sub>P</sub> (18dB) 0x0F: 19.25V <sub>P</sub> (19dB) 0x10: 21.60V <sub>P</sub> (20dB) 0x11: 24.24V <sub>P</sub> (21dB) 0x12-0x1F: Reserved

**AMP DSP Config (0x2092)**

BIT	7	6	5	4	3	2	1	0
Field	–	SPK_WBA ND_FILT_E N	SPK_SAFE _EN	SPK_VOL_ RMPDN_B YPASS	SPK_VOL_ RMPUP_BY PASS	SPK_INVE RT	SPK_DITH_ EN	SPK_DCBL K_EN
Reset	–	0x0	0x1	0b0	0b0	0b0	0b1	0b0
Access Type	–	Write, Read	Write, Read	Write, Read	Write, Read	Write, Read	Write, Read	Write, Read

BITFIELD	BITS	RES	DESCRIPTION	DECODE
SPK_WBA ND_FILT_E N	6	SPK	Enables the wideband filters in the speaker amplifier path with increased passband for sample rates higher than 50kHz.	0: Higher passband filters disabled 1: Higher passband filters enabled
SPK_SAFE _EN	5	SPK	The Safe Mode bit protects any speaker connected to the device on power up. When this setting is enabled, the SPK_VOL and SPK_GAIN_MAX settings are ignored and the amplifier output is set to -18dBFS.	0: Speaker safe mode disabled 1: Speaker safe mode enabled
SPK_VOL_ RMPDN_B YPASS	4	SPK	Controls whether the speaker amplifier path volume is internally ramped down during shutdown and during volume changes.	0: Volume ramp enabled 1: Volume ramp bypassed
SPK_VOL_ RMPUP_BY PASS	3	SPK	Controls whether the speaker amplifier path volume is internally ramped up during startup and during volume changes.	0: Volume ramp enabled 1: Volume ramp bypassed
SPK_INVE RT	2	–	Inverts the speaker amplifier path output.	0: Output is normal 1: Output is inverted
SPK_DITH_ EN	1	SPK	Selects whether or not dither is applied to the data in the speaker amplifier path.	0: Dither disabled 1: Dither enabled

BITFIELD	BITS	RES	DESCRIPTION	DECODE
SPK_DCBLK_EN	0	SPK	Controls the DC blocking filter in the speaker amplifier path.	0: DC blocking filter disabled 1: DC blocking filter enabled

**SSM Configuration (0x2093)**

BIT	7	6	5	4	3	2	1	0
Field	–	–	–	–	SPK_SSM_EN	SPK_SSM_MOD_INDEX[2:0]		
Reset	–	–	–	–	0x1	0x5		
Access Type	–	–	–	–	Write, Read	Write, Read		

BITFIELD	BITS	RES	DESCRIPTION	DECODE
SPK_SSM_EN	3	SPK	Enables Spread-Spectrum Clocking.	0: Spread-spectrum clocking is disabled 1: Spread-spectrum clocking is enabled
SPK_SSM_MOD_INDEX	2:0	SPK	Selects the modulation index for the Class-D amplifier spread-spectrum clocks. The modulation index can be varied as follows:	0x0: MMI 0x1: MMI * 5/6 0x2: MMI * 4/6 0x3: MMI * 3/6 0x4: MMI * 2/6 0x5: MMI * 1/6 0x6 to 0x7: Reserved

**SPK Class DG Threshold (0x2094)**

BIT	7	6	5	4	3	2	1	0
Field	–	–	–	SPK_DG_THRES[4:0]				
Reset	–	–	–	0x12				
Access Type	–	–	–	Write, Read				

BITFIELD	BITS	RES	DESCRIPTION	DECODE
SPK_DG_THRES	4:0	SPK	Sets the DG mode fixed peak signal level threshold (active when SPK_DG_SEL = 0x0 or 0x2).	0x00: 3.8V 0x01: 3.7V 0x02: 3.6V 0x03 to 0x1D: ... (0.1V steps) 0x1E: 0.8V 0x1F: 0.7V

**SPK Class DG Headroom (0x2095)**

BIT	7	6	5	4	3	2	1	0
Field	–	–	SPK_DG_SEL[1:0]		SPK_DG_HEADROOM[3:0]			
Reset	–	–	0x1		0x7			
Access Type	–	–	Write, Read		Write, Read			

BITFIELD	BITS	RES	DESCRIPTION	DECODE
SPK_DG_SEL	5:4	SPK	Selects the method used for speaker amplifier DG mode operation.	0x0: Class-DG mode uses a fixed peak signal level threshold (SPK_DG_THRES) 0x1: Class-DG mode uses supply headroom relative to measured VBAT voltage (SPK_DG_HEADROOM) 0x2: Class-DG mode uses the lower of fixed peak signal level threshold (SPK_DG_THRES) and VBAT supply headroom (SPK_DG_HEADROOM) 0x3: Reserved
SPK_DG_HEADROOM	3:0	SPK	Sets the DG mode headroom relative to the measured V <sub>VBAT</sub> supply level (active when SPK_DG_SEL = 0x1 or 0x2).	0x0: 0V 0x1: 0.25V 0x2: 0.5V 0x3 to 0xD: ... (0.25V steps) 0xE: 3.5V 0xF: 3.75V

**SPK Class DG Hold Time (0x2096)**

BIT	7	6	5	4	3	2	1	0
Field	–	SPK_DG_PEAK_HYST[2:0]			SPK_DG_HOLD_TIME[3:0]			
Reset	–	0x1			0x7			
Access Type	–	Write, Read			Write, Read			

BITFIELD	BITS	RES	DESCRIPTION	DECODE
SPK_DG_PEAK_HYST	6:4	SPK	Sets the signal peak hysteresis relative to the measured V <sub>VBAT</sub> supply level. In order to switch from D to G, signal peak must be less than VBAT - hysteresis.	0x0: 0.5dB 0x1: 1.0dB 0x2: 1.5dB 0x3: 2.0dB 0x4: 2.5dB 0x5: 3.0dB 0x6: 4.0dB 0x7: 5.0dB
SPK_DG_HOLD_TIME	3:0	SPK	Sets the speaker amplifier DG mode hold time. When the peak signal level falls below the DG mode threshold for longer than this time, VBAT is selected as the active amplifier supply.	0x0: 0.15ms 0x1: 0.25ms 0x2: 0.5ms 0x3: 1.0ms 0x4: 2.5ms 0x5: 5.0ms 0x6: 10ms 0x7: 20ms 0x8: 30ms 0x9: 40ms 0xA: 50ms 0xB: 125ms 0xC: 250ms 0xD: 500ms 0xE: 750ms 0xF: 1.0s



**SPK Class DG Delay (0x2097)**

BIT	7	6	5	4	3	2	1	0
Field	–	–	SPK_DG_DELAY[5:0]					
Reset	–	–	0x0					
Access Type	–	–	Write, Read					

BITFIELD	BITS	RES	DESCRIPTION	DECODE
SPK_DG_DELAY	5:0	SPK	Selects the speaker amplifier path signal delay for DG mode operation. Delays the audio output by N samples ( $N \times f_S$ ).	0x0: No delay 0x1: Delay 1 sample 0x2: Delay 2 samples 0x3 to 0x1D: ... (1 sample step) 0x1E: Delay 30 samples 0x1F: Delay 31 samples 0x20: Delay 32 samples

**SPK Class DG Mode (0x2098)**

BIT	7	6	5	4	3	2	1	0
Field	–	–	–	–	–	–	SPK_MODE[1:0]	
Reset	–	–	–	–	–	–	0x0	
Access Type	–	–	–	–	–	–	Write, Read	

BITFIELD	BITS	RES	DESCRIPTION	DECODE
SPK_MODE	1:0	–	Selects the speaker amplifier operating mode.	0x0: DG mode is enabled. 0x1: DG mode is disabled and amplifier is always supplied from PVDD pin. 0x2: DG mode is disabled and amplifier is supplied from VBAT pin when supply conditions are met. 0x3: Reserved

**SPK Class DG VBAT Level (0x2099)**

BIT	7	6	5	4	3	2	1	0
Field	–	–	–	–	–	VBATLOW_OK_LVL[2:0]		
Reset	–	–	–	–	–	0x3		
Access Type	–	–	–	–	–	Write, Read		

BITFIELD	BITS	RES	DESCRIPTION	DECODE
VBATLOW_OK_LVL	2:0	–	Sets the threshold for VBAT level below which the amplifier is forced to operate in PVDD mode only (i.e., the active amplifier supply is PVDD only).	0x0: 2.5V 0x1: 2.6V 0x2: 2.7V 0x3: 2.8V 0x4: 2.9V 0x5: 3.0V 0x6: Reserved 0x7: Reserved

**SPK Edge Control (0x209A)**

BIT	7	6	5	4	3	2	1	0
Field	–	–	–	–	–	SPK_FSW_SEL	–	–
Reset	–	–	–	–	–	0x0	–	–
Access Type	–	–	–	–	–	Write, Read	–	–

BITFIELD	BITS	RES	DESCRIPTION	DECODE
SPK_FSW_SEL	2	SPK	Controls the nominal switching frequency of the speaker amplifier.	0: 472kHz 1: 666kHz

**SPK Path Wideband Only Enable (0x209B)**

BIT	7	6	5	4	3	2	1	0
Field	–	–	–	–	–	–	–	SPK_WIDE_BAND_ONL_Y_EN
Reset	–	–	–	–	–	–	–	0b00
Access Type	–	–	–	–	–	–	–	Write, Read

BITFIELD	BITS	RES	DESCRIPTION	DECODE
SPK_WIDE_BAND_ONL_Y_EN	0	SPK	When enabled, only wideband signal is sent to the Amplifier	0x0: Ultrasound Signal Mode Disable 0x1: Ultrasound Signal Mode Enable

**SPK Edge Control 1 (0x209C)**

BIT	7	6	5	4	3	2	1	0
Field	–	–	–	–	SPK_SL_RATE_GMODE[3:0]			
Reset	–	–	–	–	0xA			
Access Type	–	–	–	–	Write, Read			

BITFIELD	BITS	RES	DESCRIPTION	DECODE
SPK_SL_RATE_GMODE	3:0	–	These bits control the on/off time of high side power FET connected to the VBAT supply pin. This in effect strongly controls rise time at OUTx nodes in VBAT mode, and weakly controls fall time at OUTx nodes in VBAT mode, as fall time is strongly controlled by SPK_SL_RATE_LS<3:0>.	Previous four codes are preferred choices.

**SPK Edge Control 2 (0x209D)**

BIT	7	6	5	4	3	2	1	0
Field	SPK_SL_RATE_LS[3:0]				SPK_SL_RATE_HS[3:0]			
Reset	0xA				0xA			
Access Type	Write, Read				Write, Read			

BITFIELD	BITS	RES	DESCRIPTION	DECODE
SPK_SL_RATE_LS	7:4	–	These bits control the on/off time of the low side power FET. This in effect strongly controls fall time at OUTx node, and weakly controls rise time at OUTx nodes. Rise times are strongly controlled by SPK_SL_RATE_GMODE in VBAT mode and SPK_SL_RATE_HS in PVDD mode.	Previous table shows four preferred codes.
SPK_SL_RATE_HS	3:0	–	These bits control the on/off time of high side power FET connected to the PVDD supply pin. This in effect strongly controls rise time at OUTx nodes, and weakly controls fall time of OUTx nodes in PVDD mode. Fall time is strongly controlled by SPK_SL_RATE_LS.	Previous table shows the preferred four codes.

**Amp Clip Gain (0x209E)**

BIT	7	6	5	4	3	2	1	0
Field	–	–	–	–	SPK_GAIN[3:0]			
Reset	–	–	–	–	0x0			
Access Type	–	–	–	–	Write, Read			

BITFIELD	BITS	RES	DESCRIPTION	DECODE
SPK_GAIN	3:0	–	Sets the digital clip gain level of the speaker amplifier path.	0x00: 0dB 0x01: 0.5dB 0x02: 1.0dB 0x03: 1.5dB 0x04: 2.0dB 0x05: 2.5dB 0x06: 3.0dB 0x07: 3.5dB 0x08: 4.0dB 0x09: 5.0dB 0x0A: 6.0dB 0x0B to 0x0F: Reserved

**Bypass Path Config (0x209F)**

BIT	7	6	5	4	3	2	1	0
Field	–	–	–	–	–	–	BYP_WBA ND_FILT_E N	BYP_INVE RT
Reset	–	–	–	–	–	–	0x0	0b0
Access Type	–	–	–	–	–	–	Write, Read	Write, Read

BITFIELD	BITS	RES	DESCRIPTION	DECODE
BYP_WBA ND_FILT_E N	1	SPK	Enables the wideband filters with increased passband for sample rates higher than 50kHz in the amplifier audio processing bypass path.	0x0: Higher passband filters disabled 0x1: Higher passband filters enabled
BYP_INVE RT	0	–	Inverts the bypass amplifier path output.	0: Output is normal 1: Output is inverted

**Amplifier Supply Control (0x20A0)**

BIT	7	6	5	4	3	2	1	0
Field	–	–	–	–	–	–	–	NOVBAT
Reset	–	–	–	–	–	–	–	0x0
Access Type	–	–	–	–	–	–	–	Write, Read

BITFIELD	BITS	RES	DESCRIPTION	DECODE
NOVBAT	0	–	Selects whether the VBAT pin is supplied from an external supply or not.	0: Do not manually enable the measurement ADC channel (can be automatically enabled) 1: Manually force the measurement ADC channel to be enabled anytime the device is in the active state

**AMP enables (0x20AF)**

BIT	7	6	5	4	3	2	1	0
Field	–	–	–	–	–	–	SPK_FB_E N	SPK_EN
Reset	–	–	–	–	–	–	0b0	0b0
Access Type	–	–	–	–	–	–	Write, Read	Write, Read

BITFIELD	BITS	RES	DESCRIPTION	DECODE
SPK_FB_E N	1	TXEN	Enables PCM data output from the end of the speaker amplifier path DSP.	0: Speaker amplifier path DSP feedback disabled 1: Speaker amplifier path DSP feedback enabled
SPK_EN	0	TXEN	Enables the speaker amplifier path.	0: Speaker amplifier is disabled 1: Speaker amplifier is enabled

Meas ADC Sample Rate (0x20B0)

BIT	7	6	5	4	3	2	1	0
Field	–	–	MEAS_ADC_TEMP_SR[1:0]		MEAS_ADC_PVDD_SR[1:0]		MEAS_ADC_VBAT_SR[1:0]	
Reset	–	–	0x3		0x0		0x0	
Access Type	–	–	Write, Read		Write, Read		Write, Read	

BITFIELD	BITS	RES	DESCRIPTION	DECODE
MEAS_ADC_TEMP_SR	5:4	EN	Configures the sample rate of the thermal channel of the measurement ADC.	0x0: 300kHz 0x1: 150kHz 0x2: 75kHz 0x3: 37.5kHz
MEAS_ADC_PVDD_SR	3:2	EN	Configures the sample rate of the PVDD channel of the measurement ADC.	00: 300kHz 01: 150kHz 10: 75kHz 11: 37.5kHz
MEAS_ADC_VBAT_SR	1:0	EN	Configures the sample rate of the VBAT channel of the measurement ADC.	0x0: 300kHz 0x1: 150kHz 0x2: 75kHz 0x3: 37.5kHz

Meas ADC PVDD Config (0x20B1)

BIT	7	6	5	4	3	2	1	0
Field	–	–	–	MEAS_ADC_PVDD_FILTER_T_EN	MEAS_ADC_PVDD_FILTER_COEFF[3:0]			
Reset	–	–	–	0x0	0x0			
Access Type	–	–	–	Write, Read	Write, Read			

BITFIELD	BITS	RES	DESCRIPTION	DECODE
MEAS_ADC_PVDD_FILTER_T_EN	4	EN	Controls whether filtering is applied to the PVDD channel output.	0: Filter is bypassed 1: Filter is applied
MEAS_ADC_PVDD_FILTER_COEFF	3:0	EN	Sets the PVDD channel lowpass filter bandwidth.	Value: Decode 0x0: 0.4kHz (Across all sample rates) 0x1: 2.5kHz (Across all sample rates) 0x2: 7.5kHz (Across all sample rates) 0x3: 50kHz (Only 150kHz and 300kHz sample rate) 0x4: 150kHz (Only 300kHz sample rate) 0x5 to 0xF: Reserved

Meas ADC VBAT Config (0x20B2)

BIT	7	6	5	4	3	2	1	0
Field	–	–	–	MEAS_ADC_VBAT_FILTER_EN	MEAS_ADC_VBAT_FILTER_COEFF[3:0]			
Reset	–	–	–	0x0	0x00			
Access Type	–	–	–	Write, Read	Write, Read			

BITFIELD	BITS	RES	DESCRIPTION	DECODE
MEAS_ADC_VBAT_FILTER_EN	4	EN	Controls whether filtering is applied to the VBAT channel output.	0: Filter is bypassed 1: Filter is applied
MEAS_ADC_VBAT_FILTER_COEFF	3:0	EN	Sets the VBAT channel lowpass filter bandwidth.	Value: Decode 0x0: 0.4kHz (Across all sample rates) 0x1: 2.5kHz (Across all sample rates) 0x2: 7.5kHz (Across all sample rates) 0x3: 50kHz (Only 150kHz and 300kHz sample rate) 0x4: 150kHz (Only 300kHz sample rate) 0x5 to 0xF: Reserved

Meas ADC Thermal Config (0x20B3)

BIT	7	6	5	4	3	2	1	0
Field	–	–	–	MEAS_ADC_TEMP_FILTER_EN	MEAS_ADC_TEMP_FILTER_COEFF[3:0]			
Reset	–	–	–	0x0	0x00			
Access Type	–	–	–	Write, Read	Write, Read			

BITFIELD	BITS	RES	DESCRIPTION	DECODE
MEAS_ADC_TEMP_FILTER_EN	4	EN	Controls whether filtering is applied to the thermal channel output.	0: Filter is bypassed 1: Filter is applied
MEAS_ADC_TEMP_FILTER_COEFF	3:0	EN	Sets the thermal channel lowpass filter bandwidth.	Value: Decode 0x0: 0.4kHz (Across all sample rates) 0x1: 2.5kHz (Across all sample rates) 0x2: 7.5kHz (Across all sample rates) 0x3: 50kHz (Only 150kHz and 300kHz sample rate) 0x4: 150kHz (Only 300kHz sample rate) 0x5 to 0xF: Reserved

Meas ADC Readback Control 1 (0x20B4)

BIT	7	6	5	4	3	2	1	0
Field	–	–	–	–	–	MEAS_ADC_THERM_RD_MODE	MEAS_ADC_VBAT_RD_MODE	MEAS_ADC_PVDD_RD_MODE
Reset	–	–	–	–	–	0x0	0x0	0x0
Access Type	–	–	–	–	–	Write, Read	Write, Read	Write, Read

BITFIELD	BITS	RES	DESCRIPTION	DECODE
MEAS_ADC_THERM_RD_MODE	2	–	Controls whether the thermal ADC channel output readback is updated automatically or manually after each conversion is completed.	0: Measurement ADC channel readback data is automatically updated 1: Initiates a measurement and locks the result into the measurement ADC channel readback register
MEAS_ADC_VBAT_RD_MODE	1	–	Controls whether the VBAT ADC channel output readback is updated automatically or manually after each conversion is completed.	0: Measurement ADC channel readback data is automatically updated 1: Initiates a measurement and locks the result into the measurement ADC channel readback register
MEAS_ADC_PVDD_RD_MODE	0	–	Controls whether the PVDD ADC channel output readback is updated automatically or manually after each conversion is completed.	0: Measurement ADC channel readback data is automatically updated 1: Initiates a measurement and locks the result into the measurement ADC channel readback register

Meas ADC Readback Control 2 (0x20B5)

BIT	7	6	5	4	3	2	1	0
Field	–	–	–	–	–	MEAS_ADC_THERM_RD_UPD	MEAS_ADC_VBAT_RD_UPD	MEAS_ADC_PVDD_RD_UPD
Reset	–	–	–	–	–	0x0	0x0	0x0
Access Type	–	–	–	–	–	Write Only	Write Only	Write Only

BITFIELD	BITS	RES	DESCRIPTION	DECODE
MEAS_ADC_THERM_RD_UPD	2	–	Write 1 to initiate a measurement and lock the result into the measurement ADC thermal channel readback register	0: No effect 1: Initiates a measurement and locks the result into the measurement ADC channel readback register
MEAS_ADC_VBAT_RD_UPD	1	–	Write 1 to initiate a measurement and locks the result into the measurement ADC VBAT channel readback register	0: No effect 1: Initiates a measurement and locks the result into the measurement ADC channel readback register
MEAS_ADC_PVDD_RD_UPD	0	–	Write 1 to initiate a measurement and lock the result into the measurement ADC PVDD channel readback register	0: No effect 1: Initiates a measurement and locks the result into the measurement ADC channel readback register

**Meas ADC PVDD Readback MSB (0x20B6)**

BIT	7	6	5	4	3	2	1	0
Field	MEAS_ADC_PVDD_DATA[8:1]							
Reset	0x0							
Access Type	Read Only							

BITFIELD	BITS	RES	DESCRIPTION
MEAS_ADC_PVDD_DATA	7:0	–	Provides the measured PVDD value. To convert the 9-bit code into a real voltage, use the following: Measured $V_{PVDD}$ (V) = 2.5V + MEAS_ADC_PVDD_DATA[8:0] x 0.038085V

**Meas ADC PVDD Readback LSB (0x20B7)**

BIT	7	6	5	4	3	2	1	0
Field	–	–	–	–	–	–	–	MEAS_ADC_PVDD_DATA[0]
Reset	–	–	–	–	–	–	–	0x0
Access Type	–	–	–	–	–	–	–	Read Only

BITFIELD	BITS	RES	DESCRIPTION
MEAS_ADC_PVDD_DATA	0	–	Provides the measured PVDD value. To convert the 9-bit code into a real voltage, use the following: Measured $V_{PVDD}$ (V) = 2.5V + MEAS_ADC_PVDD_DATA[8:0] x 0.038085V

**Meas ADC VBAT Readback MSB (0x20B8)**

BIT	7	6	5	4	3	2	1	0
Field	MEAS_ADC_VBAT_DATA[8:1]							
Reset	0x0							
Access Type	Read Only							

BITFIELD	BITS	RES	DESCRIPTION
MEAS_ADC_VBAT_DATA	7:0	–	Provides the measured VBAT value. To convert the 9-bit code into a real voltage, use the following: Measured $V_{VBAT}$ (V) = 1.25V + MEAS_ADC_VBAT_DATA[8:0] x 0.01904V



Meas ADC VBAT Readback LSB (0x20B9)

BIT	7	6	5	4	3	2	1	0
Field	–	–	–	–	–	–	–	MEAS_ADC_VBAT_DATA[0]
Reset	–	–	–	–	–	–	–	0x0
Access Type	–	–	–	–	–	–	–	Read Only

BITFIELD	BITS	RES	DESCRIPTION
MEAS_ADC_VBAT_DATA	0	–	Provides the measured VBAT value. To convert the 9-bit code into a real voltage, use the following: Measured $V_{VBAT}$ (V) = 1.25V + MEAS_ADC_VBAT_DATA[8:0] x 0.01904V

Meas ADC Temp Readback MSB (0x20BA)

BIT	7	6	5	4	3	2	1	0
Field	MEAS_ADC_THERM_DATA[8:1]							
Reset	0x0							
Access Type	Read Only							

BITFIELD	BITS	RES	DESCRIPTION
MEAS_ADC_THERM_DATA	7:0	–	Provides the measured temperature value. To convert the 9-bit code into a real temperature, use the following: Measured Temperature (°C) = (MEAS_ADC_THERM_DATA[8:0] x 1.0°C) - 208°C

Meas ADC Temp Readback LSB (0x20BB)

BIT	7	6	5	4	3	2	1	0
Field	–	–	–	–	–	–	–	MEAS_ADC_THERM_DATA[0]
Reset	–	–	–	–	–	–	–	0x0
Access Type	–	–	–	–	–	–	–	Read Only

BITFIELD	BITS	RES	DESCRIPTION
MEAS_ADC_THERM_DATA	0	–	Provides the measured temperature value. To convert the 9-bit code into a real temperature, use the following: Measured Temperature (°C) = (MEAS_ADC_THERM_DATA[8:0] x 1.0°C) - 208°C

Meas ADC Lowest PVDD Readback MSB (0x20BC)

BIT	7	6	5	4	3	2	1	0
Field	LOWEST_PVDD_DATA[8:1]							
Reset	0xFF							
Access Type	Read Only							

BITFIELD	BITS	RES	DESCRIPTION
LOWEST_PVDD_DATA	7:0	–	Provides the lowest measured PVDD value. To convert the 9-bit code into a real voltage, use the following: Measured $V_{PVDD}$ (V) = 2.5V + MEAS_ADC_PVDD_DATA[8:0] x 0.038085V

Meas ADC Lowest PVDD Readback LSB (0x20BD)

BIT	7	6	5	4	3	2	1	0
Field	–	–	–	–	–	–	–	LOWEST_PVDD_DATA[0]
Reset	–	–	–	–	–	–	–	0x1
Access Type	–	–	–	–	–	–	–	Read, Ext

BITFIELD	BITS	RES	DESCRIPTION
LOWEST_PVDD_DATA	0	–	Provides the lowest measured PVDD value. To convert the 9-bit code into a real voltage, use the following: Measured $V_{PVDD}$ (V) = 2.5V + MEAS_ADC_PVDD_DATA[8:0] x 0.038085V

Meas ADC Lowest VBAT Readback MSB (0x20BE)

BIT	7	6	5	4	3	2	1	0
Field	LOWEST_VBAT_DATA[8:1]							
Reset	0xFF							
Access Type	Read Only							

BITFIELD	BITS	RES	DESCRIPTION
LOWEST_VBAT_DATA	7:0	–	Provides the measured VBAT value. To convert the 9-bit code into a real voltage, use the following: Measured $V_{VBAT}$ (V) = 1.25V + MEAS_ADC_VBAT_DATA[8:0] x 0.01904V

Meas ADC Lowest VBAT Readback LSB (0x20BF)

BIT	7	6	5	4	3	2	1	0
Field	–	–	–	–	–	–	–	LOWEST_VBAT_DATA[0]
Reset	–	–	–	–	–	–	–	0x1
Access Type	–	–	–	–	–	–	–	Read, Ext

BITFIELD	BITS	RES	DESCRIPTION
LOWEST_VBAT_DATA	0	–	Provides the measured VBAT value. To convert the 9-bit code into a real voltage, use the following:  Measured $V_{VBAT}$ (V) = 1.25V + MEAS_ADC_VBAT_DATA[8:0] x 0.01904V

Meas ADC Config (0x20C7)

BIT	7	6	5	4	3	2	1	0
Field	–	–	–	–	–	–	MEAS_ADC_VBAT_EN	MEAS_ADC_PVDD_EN
Reset	–	–	–	–	–	–	0x0	0x0
Access Type	–	–	–	–	–	–	Write, Read	Write, Read

BITFIELD	BITS	RES	DESCRIPTION	DECODE
MEAS_ADC_VBAT_EN	1	–	Manually enables the measurement ADC VBAT channel.	0: Do not manually enable the measurement ADC channel (may be automatically enabled) 1: Manually force the measurement ADC channel to be enabled anytime the device is in the active state
MEAS_ADC_PVDD_EN	0	–	Manually enables the measurement ADC PVDD channel.	0: Do not manually enable the measurement ADC channel (may be automatically enabled) 1: Manually force the measurement ADC channel to be enabled anytime the device is in the active state

DHT Configuration 1 (0x20D0)

BIT	7	6	5	4	3	2	1	0
Field	–	–	–	–	DHT_VROT_PNT[3:0]			
Reset	–	–	–	–	0x0			
Access Type	–	–	–	–	Write, Read			

BITFIELD	BITS	RES	DESCRIPTION	DECODE
DHT_VROT_PNT	3:0	DHT	Sets the DRC rotation point.	0x0: 0dBFS 0x1: -1dBFS 0x2: -2dBFS 0x3: -3dBFS 0x4: -4dBFS 0x5: -5dBFS 0x6: -6dBFS 0x7: -8dBFS 0x8: -10dBFS 0x9: -12dBFS 0xA: -15dBFS 0xB: Reserved 0xC: Reserved 0xD: Reserved 0xE: Reserved 0xF: Reserved

**Limiters Configuration 1 (0x20D1)**

BIT	7	6	5	4	3	2	1	0
Field	-	-	-	DHT_HR[4:0]				
Reset	-	-	-	0x8				
Access Type	-	-	-	Write, Read				

BITFIELD	BITS	RES	DESCRIPTION	DECODE
DHT_HR	4:0	-	Selects the DHT supply headroom for the DRC and limiter functions.	0x0: -20% 0x1: -17.5% 0x2: -15% 0x3: -12.5% 0x4: -10% 0x5: -7.5% 0x6: -5.0% 0x7: -2.5% 0x8: 0% 0x9: +2.5% 0xA: +5.0% 0xB: +7.5% 0xC: +10% 0xD: +12.5% 0xE: +15% 0xF: +17.5% 010: +20%

**Limiters Configuration 2 (0x20D2)**

BIT	7	6	5	4	3	2	1	0
Field	-	-	DHT_LIM_THRESH[4:0]					DHT_LIM_MODE
Reset	-	-	0x0					0x0
Access Type	-	-	Write, Read					Write, Read

BITFIELD	BITS	RES	DESCRIPTION	DECODE
DHT_LIM_T HRESH	5:1	DHT	Selects the fixed threshold level for signal level limiter mode (SLL). Has no effect in signal distortion limiter mode (SDL).	00000: 0dBFS 00001: -1dBFS 00010: -2dBFS ...: (-1dBFS steps) 01110: -14dBFS 01111: -15dBFS 10000 to 11111: Reserved
DHT_LIM_ MODE	0	DHT	Selects whether the DHT limiter is in signal distortion or signal level limiter mode.	0: Signal distortion limiter mode where limiter threshold tracks supply 1: Signal level limiter mode where limiter uses fixed thresholds

**DHT Configuration 2 (0x20D3)**

BIT	7	6	5	4	3	2	1	0
Field	-	-	-	DHT_MAX_ATN[4:0]				
Reset	-	-	-	0x14				
Access Type	-	-	-	Write, Read				

BITFIELD	BITS	RES	DESCRIPTION	DECODE
DHT_MAX_ ATN	4:0	DHT	Selects the maximum attenuation that can be applied to the audio signal by the DHT.	0x0: Reserved 0x1: -1dB 0x2: -2dB 0x3: -3dB 0x4: -4dB 0x5: -5dB 0x6: -6dB 0x7: -7dB 0x8: -8dB 0x9: -9dB 0xA: -10dB 0xB: -11dB 0xC: -12dB 0xD: -13dB 0xE: -14dB 0xF: -15dB 0x10: -16dB 0x11: -17dB 0x12: -18dB 0x13: -19dB 0x14: -20dB 0x15-0x1F: Reserved

**DHT Configuration 3 (0x20D4)**

BIT	7	6	5	4	3	2	1	0
Field	-	-	-	-	DHT_ATK_RATE[3:0]			
Reset	-	-	-	-	0x2			
Access Type	-	-	-	-	Write, Read			

BITFIELD	BITS	RES	DESCRIPTION	DECODE
DHT_ATK_RATE	3:0	–	Selects the DHT attack rate.	0x0: 20µs/dB 0x1: 40µs/dB 0x2: 80µs/dB 0x3: 160µs/dB 0x4: 320µs/dB 0x5: 640µs/dB 0x6: 1.28ms/dB 0x7: 2.56ms/dB 0x8: 5.12ms/dB 0x9: 10.24ms/dB 0xA: 20.48ms/dB 0xB: 40.96ms/dB 0xC: 81.92ms/dB 0xD: 163.84ms/dB 0xE: Reserved 0xF: Reserved

**DHT Configuration 4 (0x20D5)**

BIT	7	6	5	4	3	2	1	0
Field	–	–	–	–	DHT_RLS_RATE[3:0]			
Reset	–	–	–	–	0x4			
Access Type	–	–	–	–	Write, Read			

BITFIELD	BITS	RES	DESCRIPTION	DECODE
DHT_RLS_RATE	3:0	–	Selects the DHT release rate.	0x0: 2ms/dB 0x1: 4ms/dB 0x2: 8ms/dB 0x3: 16ms/dB 0x4: 32ms/dB 0x5: 64ms/dB 0x6: 128ms/dB 0x7: 256ms/dB 0x8: 512ms/dB 0x9: 1.024s/dB 0xA: 2.048s/dB 0xB: 4.096s/dB 0xC: 8.192s/dB 0xD: 16.384s/dB 0xE: Reserved 0xF: Reserved

**DHT Supply Hysteresis Configuration (0x20D6)**

BIT	7	6	5	4	3	2	1	0
Field	–	–	–	–	DHT_SUPPLY_HYST[2:0]			DHT_SUPPLY_HYST_EN
Reset	–	–	–	–	0x3			0x1
Access Type	–	–	–	–	Write, Read			Write, Read

BITFIELD	BITS	RES	DESCRIPTION	DECODE
DHT_SUPPLY_HYST	3:1	DHT	Selects the supply hysteresis for DHT attenuation release when supply increases.	0x0: 1 LSB 0x1: 2 LSB 0x2: 3 LSB 0x3: 4 LSB 0x4: 6 LSB 0x5: 8 LSB 0x6: 10 LSB 0x7: 12 LSB 0x8: RSVD
DHT_SUPPLY_HYST_EN	0	DHT	Select whether PVDD DHT hysteresis is enabled or disabled.	0: DHT is disabled 1: DHT is enabled

**DHT Enable (0x20DF)**

BIT	7	6	5	4	3	2	1	0
Field	–	–	–	–	–	–	–	DHT_EN
Reset	–	–	–	–	–	–	–	0x0
Access Type	–	–	–	–	–	–	–	Write, Read

BITFIELD	BITS	RES	DESCRIPTION	DECODE
DHT_EN	0	SPK	Select whether DHT is enabled or disabled.	0: DHT is disabled 1: DHT is enabled

**I/V Sense Path Config (0x20E0)**

BIT	7	6	5	4	3	2	1	0
Field	–	–	–	–	IVADC_WB AND_FILT_ EN	IVADC_DIT H_EN	IVADC_I_D CBLK_EN	IVADC_V_ DCBLK_EN
Reset	–	–	–	–	0x0	0b1	0b0	0b0
Access Type	–	–	–	–	Write, Read	Write, Read	Write, Read	Write, Read

BITFIELD	BITS	RES	DESCRIPTION	DECODE
IVADC_WB AND_FILT_ EN	3	IVS	Enables the wideband filters with increased passband for sample rates higher than 50kHz in the IV ADC path	0x0: Higher passband filters disabled 0x1: Higher passband filters enabled
IVADC_DIT H_EN	2	IVS	Select whether or not dither is applied to the I/V sense ADC path.	0: Dither disabled 1: Dither enabled
IVADC_I_D CBLK_EN	1	IVS	Enables the DC blocking filter in the current sense ADC path.	0: DC blocker disabled 1: DC blocker enabled
IVADC_V_ DCBLK_EN	0	IVS	Enables the DC blocking filter in the voltage sense ADC path.	0: DC blocker disabled 1: DC blocker enabled

I/V Sense Path Enables (0x20E4)

BIT	7	6	5	4	3	2	1	0
Field	–	–	–	–	–	–	IVADC_I_EN	IVADC_V_EN
Reset	–	–	–	–	–	–	0b0	0b0
Access Type	–	–	–	–	–	–	Write, Read	Write, Read

BITFIELD	BITS	RES	DESCRIPTION	DECODE
IVADC_I_EN	1	–	Enables the speaker current sense ADC path. When this bit is set to 1, the current sense ADC path is powered up if the device is in the active state (EN = 1).	0: Speaker current sense ADC path disabled 1: Speaker current sense ADC path enabled
IVADC_V_EN	0	–	Enables the speaker voltage sense ADC path. When this bit is set to 1, the voltage sense ADC path is powered up if the device is in the active state (EN = 1).	0: Speaker voltage sense ADC path disabled 1: Speaker voltage sense ADC path enabled

BPE State (0x20E5)

BIT	7	6	5	4	3	2	1	0
Field	–	–	–	–	–	BPE_STATE[2:0]		
Reset	–	–	–	–	–	0x0		
Access Type	–	–	–	–	–	Read Only		

BITFIELD	BITS	RES	DESCRIPTION	DECODE
BPE_STATE	2:0	–	Current level of brownout controller. Reads-back 000 when EN = 0.	000: Brownout inactive—normal operation 001: Level 3 010: Level 2 011: Level 1 100: Level 0 101 to 111: Reserved

BPE L3 Threshold MSB (0x20E6)

BIT	7	6	5	4	3	2	1	0
Field	BPE_L3_VTHRESH[8:1]							
Reset	0x0							
Access Type	Write, Read							

BITFIELD	BITS	RES	DESCRIPTION
BPE_L3_VTHRESH	7:0	BPE	BPE_Ln_VTHRESH[8:0] Sets the trigger level for each threshold in the brownout controller.  Refer to the Measurement ADC CH0 (PVDD) Result register to set these levels. A value of 0000 0000 (all zeros) means that state is not used and is entirely bypassed.



**BPE L3 Threshold LSB (0x20E7)**

BIT	7	6	5	4	3	2	1	0
Field	–	–	–	–	–	–	–	BPE_L3_VTHRESH[0]
Reset	–	–	–	–	–	–	–	0x0
Access Type	–	–	–	–	–	–	–	Write, Read

BITFIELD	BITS	RES	DESCRIPTION
BPE_L3_VTHRESH	0	BPE	

**BPE L2 Threshold MSB (0x20E8)**

BIT	7	6	5	4	3	2	1	0
Field	BPE_L2_VTHRESH[8:1]							
Reset	0x0							
Access Type	Write, Read							

BITFIELD	BITS	RES	DESCRIPTION
BPE_L2_VTHRESH	7:0	BPE	BPE_Ln_VTHRESH[8:0] Sets the trigger level for each threshold in the brownout controller.  Refer to the Measurement ADC CH0 (PVDD) Result register to set these levels. A value of 0000 0000 (all zeros) means that state is not used and is entirely bypassed.

**BPE L2 Threshold LSB (0x20E9)**

BIT	7	6	5	4	3	2	1	0
Field	–	–	–	–	–	–	–	BPE_L2_VTHRESH[0]
Reset	–	–	–	–	–	–	–	0x0
Access Type	–	–	–	–	–	–	–	Write, Read

BITFIELD	BITS	RES	DESCRIPTION
BPE_L2_VTHRESH	0	BPE	

**BPE L1 Threshold MSB (0x20EA)**

BIT	7	6	5	4	3	2	1	0
Field	BPE_L1_VTHRESH[8:1]							
Reset	0x0							
Access Type	Write, Read							

BITFIELD	BITS	RES	DESCRIPTION
BPE_L1_VTHRESH	7:0	BPE	BPE_Ln_VTHRESH[8:0] Sets the trigger level for each threshold in the brownout controller.  Refer to the Measurement ADC CH0 (PVDD) Result register to set these levels. A value of 0000 0000 (all zeros) means that state is not used and is entirely bypassed.

**BPE L1 Threshold LSB (0x20EB)**

BIT	7	6	5	4	3	2	1	0
Field	–	–	–	–	–	–	–	BPE_L1_VTHRESH[0]
Reset	–	–	–	–	–	–	–	0x0
Access Type	–	–	–	–	–	–	–	Write, Read

BITFIELD	BITS	RES	DESCRIPTION
BPE_L1_VTHRESH	0	BPE	

**BPE L0 Threshold MSB (0x20EC)**

BIT	7	6	5	4	3	2	1	0
Field	BPE_L0_VTHRESH[8:1]							
Reset	0x0							
Access Type	Write, Read							

BITFIELD	BITS	RES	DESCRIPTION
BPE_L0_VTHRESH	7:0	BPE	BPE_Ln_VTHRESH[7:0] Sets the trigger level for each threshold in the brownout controller.  Refer to the Measurement ADC CH0 (PVDD) Result register to set these levels. BA value of 0000 0000 (all zeros) means that state is not used and is entirely bypassed (no hold times). Level 0 cannot be bypassed by writing all zeros.

**BPE L0 Threshold LSB (0x20ED)**

BIT	7	6	5	4	3	2	1	0
Field	–	–	–	–	–	–	–	BPE_L0_VTHRESH[0]
Reset	–	–	–	–	–	–	–	0x0
Access Type	–	–	–	–	–	–	–	Write, Read

BITFIELD	BITS	RES	DESCRIPTION
BPE_L0_VTHRESH	0	BPE	

**BPE L3 Dwell and Hold Time (0x20EE)**

BIT	7	6	5	4	3	2	1	0
<b>Field</b>	–	–	BPE_L3_DWELL[2:0]			BPE_L3_HOLD[2:0]		
<b>Reset</b>	–	–	0x0			0x0		
<b>Access Type</b>	–	–	Write, Read			Write, Read		

BITFIELD	BITS	RES	DESCRIPTION	DECODE
BPE_L3_DWELL	5:3	BPE	Sets BPE level 3 gain attenuation dwell time.	0x0: 0µs 0x1: 100µs 0x2: 250µs 0x3: 500µs 0x4: 1000µs 0x5: 2000µs 0x6: 4000µs 0x7: 8000µs
BPE_L3_HOLD	2:0	BPE	Sets BPE level 3 gain attenuation hold time.	0x0: 0ms 0x1: 10ms 0x2: 100ms 0x3: 250ms 0x4: 500ms 0x5: 1000ms 0x6: 2000ms 0x7: Infinite

**BPE L2 Dwell and Hold Time (0x20EF)**

BIT	7	6	5	4	3	2	1	0
<b>Field</b>	–	–	BPE_L2_DWELL[2:0]			BPE_L2_HOLD[2:0]		
<b>Reset</b>	–	–	0x0			0x0		
<b>Access Type</b>	–	–	Write, Read			Write, Read		

BITFIELD	BITS	RES	DESCRIPTION	DECODE
BPE_L2_DWELL	5:3	BPE	Sets BPE level 2 gain attenuation dwell time.	0x0: 0µs 0x1: 100µs 0x2: 250µs 0x3: 500µs 0x4: 1000µs 0x5: 2000µs 0x6: 4000µs 0x7: 8000µs
BPE_L2_HOLD	2:0	BPE	Sets BPE level 2 gain attenuation hold time.	0x0: 0ms 0x1: 10ms 0x2: 100ms 0x3: 250ms 0x4: 500ms 0x5: 1000ms 0x6: 2000ms 0x7: Infinite

**BPE L1 Dwell and Hold Time (0x20F0)**

BIT	7	6	5	4	3	2	1	0
Field	–	–	BPE_L1_DWELL[2:0]			BPE_L1_HOLD[2:0]		
Reset	–	–	0x0			0x0		
Access Type	–	–	Write, Read			Write, Read		

BITFIELD	BITS	RES	DESCRIPTION	DECODE
BPE_L1_DWELL	5:3	BPE	Sets BPE level 1 gain attenuation dwell time.	0x0: 0µs 0x1: 100µs 0x2: 250µs 0x3: 500µs 0x4: 1000µs 0x5: 2000µs 0x6: 4000µs 0x7: 8000µs
BPE_L1_HOLD	2:0	BPE	Sets BPE level 1 gain attenuation hold time.	0x0: 0ms 0x1: 10ms 0x2: 100ms 0x3: 250ms 0x4: 500ms 0x5: 1000ms 0x6: 2000ms 0x7: Infinite

**BPE L0 Hold Time (0x20F1)**

BIT	7	6	5	4	3	2	1	0
Field	–	–	–	–	–	BPE_L0_HOLD[2:0]		
Reset	–	–	–	–	–	0x0		
Access Type	–	–	–	–	–	Write, Read		

BITFIELD	BITS	RES	DESCRIPTION	DECODE
BPE_L0_HOLD	2:0	BPE	Sets BPE level 0 gain attenuation hold time.	0x0: 0ms 0x1: 10ms 0x2: 100ms 0x3: 250ms 0x4: 500ms 0x5: 1000ms 0x6: 2000ms 0x7: Infinite

**BPE L3 Attack and Release Step (0x20F2)**

BIT	7	6	5	4	3	2	1	0
Field	–	–	–	–	BPE_L3_STEP[3:0]			
Reset	–	–	–	–	0x0			
Access Type	–	–	–	–	Write, Read			

BITFIELD	BITS	RES	DESCRIPTION	DECODE
BPE_L3_STEP	3:0	BPE	Sets BPE level 3 gain and limiter attenuation step size.	0x0: 0.0625dB 0x1: 0.125dB 0x2: 0.1875dB 0x3: 0.25dB 0x4: 0.375dB 0x5: 0.5dB 0x6: 0.75dB 0x7: 1.0dB 0x8: 1.5dB 0x9: 2.0dB 0xA: 2.5dB 0xB: 3.0dB 0xC: 4.0dB 0xD: 5.0dB 0xE: 5.5dB for attack / 5.0dB for release 0xF: 6.0dB for attack / 5.0dB for release

#### BPE L2 Attack and Release Step (0x20F3)

BIT	7	6	5	4	3	2	1	0
Field	–	–	–	–	BPE_L2_STEP[3:0]			
Reset	–	–	–	–	0x0			
Access Type	–	–	–	–	Write, Read			

BITFIELD	BITS	RES	DESCRIPTION	DECODE
BPE_L2_STEP	3:0	BPE	Sets BPE level 2 gain and limiter attenuation step size.	0x0: 0.0625dB 0x1: 0.125dB 0x2: 0.1875dB 0x3: 0.25dB 0x4: 0.375dB 0x5: 0.5dB 0x6: 0.75dB 0x7: 1.0dB 0x8: 1.5dB 0x9: 2.0dB 0xA: 2.5dB 0xB: 3.0dB 0xC: 4.0dB 0xD: 5.0dB 0xE: 5.5dB for attack / 6.0dB for release 0xF: 6.0dB for attack / 6.0dB for release

#### BPE L1 Attack and Release Step (0x20F4)

BIT	7	6	5	4	3	2	1	0
Field	–	–	–	–	BPE_L1_STEP[3:0]			
Reset	–	–	–	–	0x0			
Access Type	–	–	–	–	Write, Read			

BITFIELD	BITS	RES	DESCRIPTION	DECODE
BPE_L1_STEP	3:0	BPE	Sets BPE level 1 gain and limiter attenuation step size.	0x0: 0.0625dB 0x1: 0.125dB 0x2: 0.1875dB 0x3: 0.25dB 0x4: 0.375dB 0x5: 0.5dB 0x6: 0.75dB 0x7: 1.0dB 0x8: 1.5dB 0x9: 2.0dB 0xA: 2.5dB 0xB: 3.0dB 0xC: 4.0dB 0xD: 5.0dB 0xE: 5.5dB for attack/ 6.0dB for release 0xF: 6.0dB for attack / 6.0dB for release

**BPE L0 Attack and Release Step (0x20F5)**

BIT	7	6	5	4	3	2	1	0
Field	-	-	-	-	BPE_L0_STEP[3:0]			
Reset	-	-	-	-	0x0			
Access Type	-	-	-	-	Write, Read			

BITFIELD	BITS	RES	DESCRIPTION	DECODE
BPE_L0_STEP	3:0	BPE	Sets BPE level 0 gain and limiter attenuation step size.	Value: Decode 0x0: 0.0625dB 0x1: 0.125dB 0x2: 0.1875dB 0x3: 0.25dB 0x4: 0.375dB 0x5: 0.5dB 0x6: 0.75dB 0x7: 1.0dB 0x8: 1.5dB 0x9: 2.0dB 0xA: 2.5dB 0xB: 3.0dB 0xC: 4.0dB 0xD: 5.0dB 0xE: 5.5dB attack / 5.0dB release 0xF: 6.0dB attack / 5.0dB release

**BPE L3 Max Gain Attn (0x20F6)**

BIT	7	6	5	4	3	2	1	0
Field	-	-	-	BPE_L3_MAXATTN[4:0]				
Reset	-	-	-	0x0				
Access Type	-	-	-	Write, Read				

BITFIELD	BITS	RES	DESCRIPTION	DECODE
BPE_L3_M AXATTN	4:0	BPE	Sets BPE level 3 maximum gain attenuation.	0x0: 0dB 0x1: -1dB 0x2: -2dB 0x3: -3dB 0x4.. 0x1D: ...(-1dB steps) 0x1E: -30dB 0x1F: -31dB

**BPE L2 Max Gain Attn (0x20F7)**

BIT	7	6	5	4	3	2	1	0
Field	-	-	-	BPE_L2_MAXATTN[4:0]				
Reset	-	-	-	0x0				
Access Type	-	-	-	Write, Read				

BITFIELD	BITS	RES	DESCRIPTION	DECODE
BPE_L2_M AXATTN	4:0	BPE	Sets BPE level 2 maximum gain attenuation.	0x0: 0dB 0x1: -1dB 0x2: -2dB 0x3: -3dB 0x4.. 0x1D: ...(-1dB steps) 0x1E: -30dB 0x1F: -31dB

**BPE L1 Max Gain Attn (0x20F8)**

BIT	7	6	5	4	3	2	1	0
Field	-	-	-	BPE_L1_MAXATTN[4:0]				
Reset	-	-	-	0x0				
Access Type	-	-	-	Write, Read				

BITFIELD	BITS	RES	DESCRIPTION	DECODE
BPE_L1_M AXATTN	4:0	BPE	Sets BPE level 1 maximum gain attenuation.	0x0: 0dB 0x1: -1dB 0x2: -2dB 0x3: -3dB 0x4.. 0x1D: ...(-1dB steps) 0x1E: -30dB 0x1F: -31dB

**BPE L0 Max Gain Attn (0x20F9)**

BIT	7	6	5	4	3	2	1	0
Field	–	–	–	BPE_L0_MAXATTN[4:0]				
Reset	–	–	–	0x0				
Access Type	–	–	–	Write, Read				

BITFIELD	BITS	RES	DESCRIPTION	DECODE
BPE_L0_MAXATTN	4:0	BPE	Sets BPE level 0 maximum gain attenuation.	0x0: 0dB 0x1: -1dB 0x2: -2dB 0x3: -3dB 0x4.. 0x1D: ...(-1dB steps) 0x1E: -30dB 0x1F: -31dB

**BPE L3 Gain Attack and RIs Rates (0x20FA)**

BIT	7	6	5	4	3	2	1	0
Field	–	–	BPE_L3_GAIN_RLS[2:0]			BPE_L3_GAIN_ATK[2:0]		
Reset	–	–	0x0			0x0		
Access Type	–	–	Write, Read			Write, Read		

BITFIELD	BITS	RES	DESCRIPTION	DECODE
BPE_L3_GAIN_RLS	5:3	BPE	Sets BPE level 3 gain attenuation release rate.	0x0: 5ms/step 0x1: 10ms/step 0x2: 25ms/step 0x3: 50ms/step 0x4: 100ms/step 0x5: 250ms/step 0x6: 500ms/step 0x7: 1000ms/step
BPE_L3_GAIN_ATK	2:0	BPE	Sets BPE level 3 gain attenuation attack rate.	0x0: 2.5µs/step 0x1: 5µs/step 0x2: 10µs/step 0x3: 25µs/step 0x4: 50µs/step 0x5: 100µs/step 0x6: 250µs/step 0x7: 500µs/step

**BPE L2 Gain Attack and RIs Rates (0x20FB)**

BIT	7	6	5	4	3	2	1	0
Field	–	–	BPE_L2_GAIN_RLS[2:0]			BPE_L2_GAIN_ATK[2:0]		
Reset	–	–	0x0			0x0		
Access Type	–	–	Write, Read			Write, Read		



BITFIELD	BITS	RES	DESCRIPTION	DECODE
BPE_L2_G AIN_RLS	5:3	BPE	Sets BPE level 2 gain attenuation release rate.	0x0: 5ms/step 0x1: 10ms/step 0x2: 25ms/step 0x3: 50ms/step 0x4: 100ms/step 0x5: 250ms/step 0x6: 500ms/step 0x7: 1000ms/step
BPE_L2_G AIN_ATK	2:0	BPE	Sets BPE level 2 gain attenuation attack rate.	0x0: 2.5µs/step 0x1: 5µs/step 0x2: 10µs/step 0x3: 25µs/step 0x4: 50µs/step 0x5: 100µs/step 0x6: 250µs/step 0x7: 500µs/step

#### BPE L1 Gain Attack and Rls Rates (0x20FC)

BIT	7	6	5	4	3	2	1	0
Field	–	–	BPE_L1_GAIN_RLS[2:0]			BPE_L1_GAIN_ATK[2:0]		
Reset	–	–	0x0			0x0		
Access Type	–	–	Write, Read			Write, Read		

BITFIELD	BITS	RES	DESCRIPTION	DECODE
BPE_L1_G AIN_RLS	5:3	BPE	Sets BPE level 1 gain attenuation release rate.	0x0: 5ms/step 0x1: 10ms/step 0x2: 25ms/step 0x3: 50ms/step 0x4: 100ms/step 0x5: 250ms/step 0x6: 500ms/step 0x7: 1000ms/step
BPE_L1_G AIN_ATK	2:0	BPE	Sets BPE level 1 gain attenuation attack rate.	0x0: 2.5µs/step 0x1: 5µs/step 0x2: 10µs/step 0x3: 25µs/step 0x4: 50µs/step 0x5: 100µs/step 0x6: 250µs/step 0x7: 500µs/step

#### BPE L0 Gain Attack and Rls Rates (0x20FD)

BIT	7	6	5	4	3	2	1	0
Field	–	–	BPE_L0_GAIN_RLS[2:0]			BPE_L0_GAIN_ATK[2:0]		
Reset	–	–	0x0			0x0		
Access Type	–	–	Write, Read			Write, Read		

BITFIELD	BITS	RES	DESCRIPTION	DECODE
BPE_L0_G AIN_RLS	5:3	BPE	Sets BPE level 0 gain attenuation release rate.	0x0: 5ms/step 0x1: 10ms/step 0x2: 25ms/step 0x3: 50ms/step 0x4: 100ms/step 0x5: 250ms/step 0x6: 500ms/step 0x7: 1000ms/step
BPE_L0_G AIN_ATK	2:0	BPE	Sets BPE level 0 gain attenuation attack rate.	0x0: 2.5µs/step 0x1: 5µs/step 0x2: 10µs/step 0x3: 25µs/step 0x4: 50µs/step 0x5: 100µs/step 0x6: 250µs/step 0x7: 500µs/step

**BPE L3 Limiter Config (0x20FE)**

BIT	7	6	5	4	3	2	1	0
Field	-	-	-	-	BPE_L3_LIM[3:0]			
Reset	-	-	-	-	0x0			
Access Type	-	-	-	-	Write, Read			

BITFIELD	BITS	RES	DESCRIPTION	DECODE
BPE_L3_LI M	3:0	BPE	Sets the limiter threshold for BPE level 3.	0x0: 0dBFS 0x1: -1dBFS 0x2: -2dBFS 0x3: -3dBFS 0x4: -4dBFS 0x5: -5dBFS 0x6: -6dBFS 0x7: -7dBFS 0x8: -8dBFS 0x9: -9dBFS 0xA: -10dBFS 0xB: -11dBFS 0xC: -12dBFS 0xD: -13dBFS 0xE: -14dBFS 0xF: -15dBFS

**BPE L2 Limiter Config (0x20FF)**

BIT	7	6	5	4	3	2	1	0
Field	-	-	-	-	BPE_L2_LIM[3:0]			
Reset	-	-	-	-	0x0			
Access Type	-	-	-	-	Write, Read			

BITFIELD	BITS	RES	DESCRIPTION	DECODE
BPE_L2_LIM	3:0	BPE	Sets the limiter threshold for BPE level 2.	0x0: 0dBFS 0x1: -1dBFS 0x2: -2dBFS 0x3: -3dBFS 0x4: -4dBFS 0x5: -5dBFS 0x6: -6dBFS 0x7: -7dBFS 0x8: -8dBFS 0x9: -9dBFS 0xA: -10dBFS 0xB: -11dBFS 0xC: -12dBFS 0xD: -13dBFS 0xE: -14dBFS 0xF: -15dBFS

**BPE L1 Limiter Config (0x2100)**

BIT	7	6	5	4	3	2	1	0
Field	-	-	-	-	BPE_L1_LIM[3:0]			
Reset	-	-	-	-	0x0			
Access Type	-	-	-	-	Write, Read			

BITFIELD	BITS	RES	DESCRIPTION	DECODE
BPE_L1_LIM	3:0	BPE	Sets the limiter threshold for BPE level 1.	0x0: 0dBFS 0x1: -1dBFS 0x2: -2dBFS 0x3: -3dBFS 0x4: -4dBFS 0x5: -5dBFS 0x6: -6dBFS 0x7: -7dBFS 0x8: -8dBFS 0x9: -9dBFS 0xA: -10dBFS 0xB: -11dBFS 0xC: -12dBFS 0xD: -13dBFS 0xE: -14dBFS 0xF: -15dBFS

**BPE L0 Limiter Config (0x2101)**

BIT	7	6	5	4	3	2	1	0
Field	-	-	-	-	BPE_L0_LIM[3:0]			
Reset	-	-	-	-	0x0			
Access Type	-	-	-	-	Write, Read			

BITFIELD	BITS	RES	DESCRIPTION	DECODE
BPE_L0_LIM	3:0	BPE	Sets the limiter threshold for BPE level 0.	0x0: 0dBFS 0x1: -1dBFS 0x2: -2dBFS 0x3: -3dBFS 0x4: -4dBFS 0x5: -5dBFS 0x6: -6dBFS 0x7: -7dBFS 0x8: -8dBFS 0x9: -9dBFS 0xA: -10dBFS 0xB: -11dBFS 0xC: -12dBFS 0xD: -13dBFS 0xE: -14dBFS 0xF: -15dBFS

#### BPE L3 Limiter Attack and Release Rates (0x2102)

BIT	7	6	5	4	3	2	1	0
Field	–	–	BPE_L3_LIM_RLS[2:0]			BPE_L3_LIM_ATK[2:0]		
Reset	–	–	0x0			0x0		
Access Type	–	–	Write, Read			Write, Read		

BITFIELD	BITS	RES	DESCRIPTION	DECODE
BPE_L3_LIM_RLS	5:3	BPE	Sets BPE level 3 limiter release rate.	0x0: 5ms/step 0x1: 10ms/step 0x2: 25ms/step 0x3: 50ms/step 0x4: 100ms/step 0x5: 250ms/step 0x6: 500ms/step 0x7: 1000ms/step
BPE_L3_LIM_ATK	2:0	BPE	Sets BPE level 3 limiter attack rate.	0x0: 2.5µs/step 0x1: 5µs/step 0x2: 10µs/step 0x3: 25µs/step 0x4: 50µs/step 0x5: 100µs/step 0x6: 250µs/step 0x7: 500µs/step

#### BPE L2 Limiter Attack and Release Rates (0x2103)

BIT	7	6	5	4	3	2	1	0
Field	–	–	BPE_L2_LIM_RLS[2:0]			BPE_L2_LIM_ATK[2:0]		
Reset	–	–	0x0			0x0		
Access Type	–	–	Write, Read			Write, Read		

BITFIELD	BITS	RES	DESCRIPTION	DECODE
BPE_L2_LI M_RLS	5:3	BPE	Sets BPE level 2 limiter release rate.	0x0: 5ms/step 0x1: 10ms/step 0x2: 25ms/step 0x3: 50ms/step 0x4: 100ms/step 0x5: 250ms/step 0x6: 500ms/step 0x7: 1000ms/step
BPE_L2_LI M_ATK	2:0	BPE	Sets BPE level 2 limiter attack rate.	0x0: 2.5µs/step 0x1: 5µs/step 0x2: 10µs/step 0x3: 25µs/step 0x4: 50µs/step 0x5: 100µs/step 0x6: 250µs/step 0x7: 500µs/step

#### BPE L1 Limiter Attack and Release Rates (0x2104)

BIT	7	6	5	4	3	2	1	0
Field	–	–	BPE_L1_LIM_RLS[2:0]			BPE_L1_LIM_ATK[2:0]		
Reset	–	–	0x0			0x0		
Access Type	–	–	Write, Read			Write, Read		

BITFIELD	BITS	RES	DESCRIPTION	DECODE
BPE_L1_LI M_RLS	5:3	BPE	Sets BPE level 1 limiter release rate.	0x0: 5ms/step 0x1: 10ms/step 0x2: 25ms/step 0x3: 50ms/step 0x4: 100ms/step 0x5: 250ms/step 0x6: 500ms/step 0x7: 1000ms/step
BPE_L1_LI M_ATK	2:0	BPE	Sets BPE level 1 limiter attack rate.	0x0: 2.5µs/step 0x1: 5µs/step 0x2: 10µs/step 0x3: 25µs/step 0x4: 50µs/step 0x5: 100µs/step 0x6: 250µs/step 0x7: 500µs/step

#### BPE L0 Limiter Attack and Release Rates (0x2105)

BIT	7	6	5	4	3	2	1	0
Field	–	–	BPE_L0_LIM_RLS[2:0]			BPE_L0_LIM_ATK[2:0]		
Reset	–	–	0x0			0x0		
Access Type	–	–	Write, Read			Write, Read		

BITFIELD	BITS	RES	DESCRIPTION	DECODE
BPE_LO_LI M_RLS	5:3	BPE	Sets BPE level 0 limiter release rate.	0x0: 5ms/step 0x1: 10ms/step 0x2: 25ms/step 0x3: 50ms/step 0x4: 100ms/step 0x5: 250ms/step 0x6: 500ms/step 0x7: 1000ms/step
BPE_LO_LI M_ATK	2:0	BPE	Sets BPE level 0 limiter attack rate.	0x0: 2.5µs/step 0x1: 5µs/step 0x2: 10µs/step 0x3: 25µs/step 0x4: 50µs/step 0x5: 100µs/step 0x6: 250µs/step 0x7: 500µs/step

**BPE Threshold Hysteresis (0x2106)**

BIT	7	6	5	4	3	2	1	0
Field	BPE_VTHRESH_HYST[7:0]							
Reset	0x0							
Access Type	Write, Read							

BITFIELD	BITS	RES	DESCRIPTION	DECODE
BPE_VTHR ESH_HYST	7:0	BPE	Sets the hysteresis to move up to the next level in the brownout controller.  Refer to the Measurement ADC PVDD or VBAT channel result register to set these levels.	00000000: No hysteresis 00000001: 1 LSB of hysteresis 00000010: 2 LSBs of hysteresis ...: 1 LSB steps 11111101: 253 LSBs of hysteresis 11111110: 254 LSBs of hysteresis 11111111: 255 LSBs of hysteresis

**BPE Infinite Hold Clear (0x2107)**

BIT	7	6	5	4	3	2	1	0
Field	-	-	-	-	-	-	-	BPE_HLD_RLS
Reset	-	-	-	-	-	-	-	
Access Type	-	-	-	-	-	-	-	Write Only

BITFIELD	BITS	RES	DESCRIPTION	DECODE
BPE_HLD_RLS	0	BPE	Manually releases the BPE controller when infinite hold is enabled.	0x0: Writing 0 has no effect 0x1: Release brownout-prevention-engine controller from infinite hold

**BPE Supply Source (0x2108)**

BIT	7	6	5	4	3	2	1	0
Field	–	–	–	–	–	–	–	BPE_SRC_SEL
Reset	–	–	–	–	–	–	–	0x0
Access Type	–	–	–	–	–	–	–	Write, Read

BITFIELD	BITS	RES	DESCRIPTION	DECODE
BPE_SRC_SEL	0	BPE	This bit selects the measurement ADC channel that is used as the input to the brownout-prevention-engine controller.	0x0: Measurement ADC PVDD channel is the input to the BPE controller 0x1: Measurement ADC VBAT channel is the input to the BPE controller

**BPE Lowest State (0x2109)**

BIT	7	6	5	4	3	2	1	0
Field	–	–	–	–	–	BPE_LOWEST[2:0]		
Reset	–	–	–	–	–	0x0		
Access Type	–	–	–	–	–	Read, Ext		

BITFIELD	BITS	RES	DESCRIPTION	DECODE
BPE_LOWEST	2:0	–	Returns the lowest level the brownout-prevention engine has transitioned to. Upon reading the register it is updated to show the current level of the brownout controller.	000: Brownout inactive—normal operation 001: Level 3 010: Level 2 011: Level 1 100: Level 0 101 to 111: Reserved

**BPE Lowest Gain (0x210A)**

BIT	7	6	5	4	3	2	1	0
Field	BPE_LOWEST_GAIN[7:0]							
Reset	0x0							
Access Type	Read, Ext							

BITFIELD	BITS	RES	DESCRIPTION
BPE_LOWEST_GAIN	7:0	–	Returns the lowest gain (highest gain attenuation) applied by the brownout-prevention engine since the register was last read. Gain format: 5 bit integer and 3 bit fraction. Integer part is 1dB per step while fractional part is 1/8dB per step.

**BPE Lowest Limiter (0x210B)**

BIT	7	6	5	4	3	2	1	0
Field	BPE_LOWEST_LIMIT[7:0]							
Reset	0x0							
Access Type	Read, Ext							

BITFIELD	BITS	RES	DESCRIPTION
BPE_LOWEST_LIMIT	7:0	–	Returns the lowest limiter setting applied by the brownout-prevention engine since the register was last read. Limiter format: 4 bit integer and 4 bit fraction. Integer part is 1dB per step while fractional part is 1/16dB per step.

**BPE Enable (0x210D)**

BIT	7	6	5	4	3	2	1	0
Field	–	–	–	–	–	–	BPE_LIM_EN	BPE_EN
Reset	–	–	–	–	–	–	0x0	0x0
Access Type	–	–	–	–	–	–	Write, Read	Write, Read

BITFIELD	BITS	RES	DESCRIPTION	DECODE
BPE_LIM_EN	1	EN	Enables BPE Limiter function	0x0: BPE Limiter disabled 0x1: BPE Limiter enabled
BPE_EN	0	–	Enables BPE function	0x0: BPE disabled 0x1: BPE enabled

**Auto-Restart Behavior (0x210E)**

BIT	7	6	5	4	3	2	1	0
Field	–	–	–	–	OVC_AUTO RESTART_ EN	THERM_AU TORESTAR T_EN	VBAT_AUT ORESTART _EN	PVDD_AUT ORESTART _EN
Reset	–	–	–	–	0b0	0b0	0b0	0b0
Access Type	–	–	–	–	Write, Read	Write, Read	Write, Read	Write, Read

BITFIELD	BITS	RES	DESCRIPTION	DECODE
OVC_AUTO RESTART_ EN	3	EN	Controls whether or not the speaker amplifier is automatically reenabled after an overcurrent fault condition.	0: Overcurrent recovery is in manual mode 1: Overcurrent recovery is in auto mode
THERM_AU TORESTAR T_EN	2	EN	Controls whether or not the device automatically returns to the active state when the die temperature recovers from thermal shutdown.	0: Thermal shutdown recovery is in manual mode 1: Thermal shutdown recovery is in auto mode



BITFIELD	BITS	RES	DESCRIPTION	DECODE
VBAT_AUT ORESTART _EN	1	EN	Controls whether or not the device automatically returns to the active state when VBAT recovers from UVLO event.	0: VBAT UVLO recovery is in manual mode 1: VBAT UVLO recovery is in auto mode
PVDD_AUT ORESTART _EN	0	EN	Controls whether or not the device automatically returns to the active state when PVDD recovers from UVLO event.	0: PVDD UVLO recovery is in manual mode 1: PVDD UVLO recovery is in auto mode

**Global Enable (0x210F)**

BIT	7	6	5	4	3	2	1	0
Field	–	–	–	–	–	–	–	EN
Reset	–	–	–	–	–	–	–	0x0
Access Type	–	–	–	–	–	–	–	Write, Read, Ext

BITFIELD	BITS	RES	DESCRIPTION	DECODE
EN	0	–	Disable or enable all blocks and reset all logic except the I <sup>2</sup> C interface and control registers.	0: Device powered down 1: Device enabled

**Revision ID (0x21FF)**

BIT	7	6	5	4	3	2	1	0
Field	REV_ID[7:0]							
Reset	0x40							
Access Type	Read Only							

BITFIELD	BITS	RES	DESCRIPTION	DECODE
REV_ID	7:0	–	Revision of the device. Updated at every device revision.	0x40: Device revision

## Applications Information

### Layout and Grounding

Proper layout and grounding are essential for optimal performance; use at least four PCB layers and add thermal vias to the ground/power plane close to the device to ensure good thermal performance and high-end output power. Good grounding improves audio performance and prevents switching noise from coupling into the audio signal. Ground the power signals and the analog signals of the IC separately at the system ground plane to prevent switching interference from corrupting sensitive analog signals. Place the recommended supply decoupling capacitors as close as possible to the IC. The PVDD to PGND connection must be kept short and should have minimal trace length and loop area to ensure optimal performance. Use wide, low-resistance output, supply, and ground traces. As load impedance decreases, the current drawn from the device outputs increase. At higher current, the resistance of the output traces decreases the power delivered to the load. For example, if 2W is delivered from the speaker output to a 4Ω load through a 100mΩ trace, 49mW is consumed in the trace. If power is delivered through a 10mΩ trace, only 5mW is consumed in the trace. Wide output, supply, and ground traces also improve the power dissipation of the device. The device is inherently designed for excellent RF immunity. For best performance, add ground fills around all signal traces on the top and bottom PCB planes. It is advisable to follow the layout of the MAX98396 EV kit as closely as possible in the application. Thermal and performance measurements shown in this data sheet were measured with a 6-layer board ( $\theta_{JA} = 33^{\circ}\text{C/W}$ ). As a result, the EV kit performance is likely better than what can be achieved with a JEDEC standard board.

### Recommended External Components

[Table 12](#) shows the recommended external components. See the [Typical Application Circuits](#) for more details.

**Table 12. Component List**

BUMP	VALUE	SIZE	VOLTAGE RATING (V)	DIELECTRIC
PVDD	220μF ± 20%	—	35	Alum-Elec
PVDD	10μF ± 20%	0603	25	X5R
PVDD	10μF ± 20%	0603	25	X5R
PVDD	0.1μF ± 10%	0402	25	X5R
PVDD	0.1μF ± 10%	0402	25	X5R
VBAT	1μF	0201	16	X5R
VBAT	10μF	0603	25	X5R
VREFC	1μF ± 20%	0201	6.3	X5R
DVDD	1μF ± 20%	0201	6.3	X5R
DVDDIO	1μF ± 20%	0201	6.3	X5R
AVDD	1μF ± 20%	0201	6.3	X5R

Typical Application Circuits

Typical Application Circuit

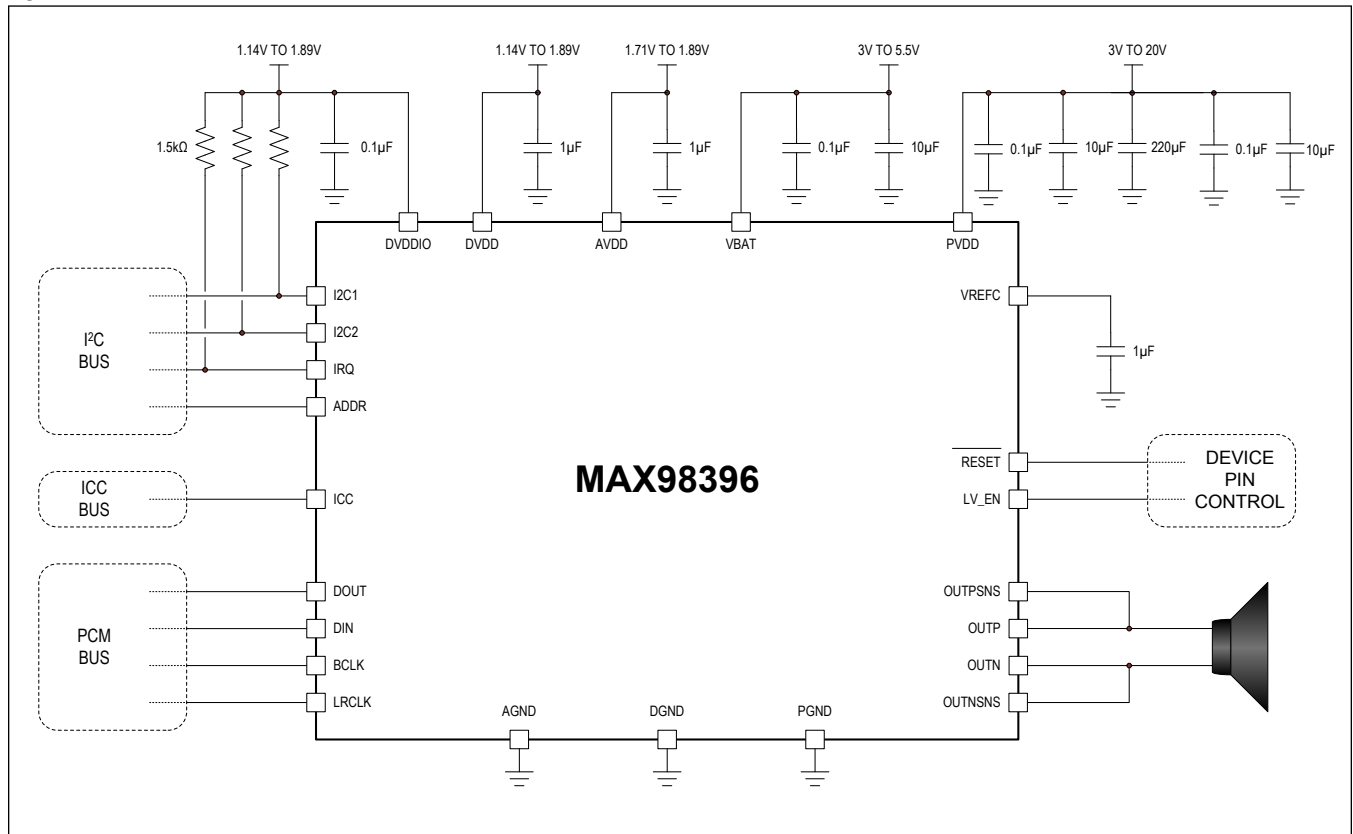

Ordering Information

PART NUMBER	TEMP RANGE	PIN-PACKAGE
MAX98396EWB+	-40°C to +85°C	35 WLP
MAX98396EWB+T	-40°C to +85°C	35 WLP

+Denotes a lead(Pb)-free/RoHA-compliant package.

T = Tape and reel.

## Revision History

REVISION NUMBER	REVISION DATE	DESCRIPTION	PAGES CHANGED
0	3/21	Initial release	—
1	4/21	Added <i>Package Information</i> section, updated <i>Electrical Characteristics</i> table, updated supported TDM mode configurations in Table 5, added SPK_WIDEBAND_ONLY_EN bit to register map	10, 11-14, 16, 22, 24, 43, 44, 91, 138

For pricing, delivery, and ordering information, please visit Maxim Integrated's online storefront at <https://www.maximintegrated.com/en/storefront/storefront.html>.

*Maxim Integrated cannot assume responsibility for use of any circuitry other than circuitry entirely embodied in a Maxim Integrated product. No circuit patent licenses are implied. Maxim Integrated reserves the right to change the circuitry and specifications without notice at any time. The parametric values (min and max limits) shown in the Electrical Characteristics table are guaranteed. Other parametric values quoted in this data sheet are provided for guidance.*

## X-ON Electronics

Largest Supplier of Electrical and Electronic Components

*Click to view similar products for [Audio Amplifiers](#) category:*

*Click to view products by [Maxim](#) manufacturer:*

Other Similar products are found below :

[LV47002P-E](#) [NCP2811AFCT1G](#) [NCP2890AFCT2G](#) [SSM2377ACBZ-R7](#) [IS31AP4915A-QFLS2-TR](#) [NCP2820FCT2G](#) [TDA1591T](#)  
[TDA7563AH](#) [SSM2529ACBZ-R7](#) [MAX9890AETA+T](#) [TS2012EIJT](#) [NCP2809BMUTXG](#) [NJW1157BFC2](#) [SSM2375CBZ-REEL7](#)  
[IS31AP4996-GRLS2-TR](#) [STPA002OD-4WX](#) [NCP2823BFCT1G](#) [MAX9717DETA+T](#) [MAX9717CETA+T](#) [MAX9724AEBC+TG45](#)  
[LA4450L-E](#) [IS31AP2036A-CLS2-TR](#) [TDA7563ASMTR](#) [AS3561-DWLT](#) [SSM2517CBZ-R7](#) [MP1720DH-12-LF-P](#) [SABRE9601K](#)  
[THAT1646W16-U](#) [PAM8965ZLA40-13](#) [BD37532FV-E2](#) [BD5638NUX-TR](#) [BD37512FS-E2](#) [BD37543FS-E2](#) [BD3814FV-E2](#)  
[TPA3140D2PWPR](#) [TS2007EIJT](#) [IS31AP2005-DLS2-TR](#) [SSM2518CPZ-R7](#) [AS3410-EQFP-500](#) [FDA4100LV](#) [TS4994EIJT](#) [NCP2820FCT1G](#)  
[NCP2823AFCT2G](#) [NCS2211MNTXG](#) [CPA2233CQ16-A1](#) [OPA1604AIPWR](#) [OPA1612AQDRQ1](#) [TDA7492](#) [SSM2519ACBZ-R7](#)  
[ZXCD1210JB16TA](#)