

MAXM15062 3.3V Output Evaluation Kit

Evaluates: MAXM15062 3.3V Output-Voltage Application

General Description

The MAXM15062 3.3V output evaluation kit (EV kit) provides a proven design to evaluate the MAXM15062 high-voltage, high-efficiency, synchronous step-down DC-DC module. The EV kit is programmed to deliver 3.3V output for loads up to 300mA. The EV kit features an adjustable input undervoltage lockout, selectable mode, and open-drain $\overline{\text{RESET}}$ signal. The MAXM15062 data sheet provides a complete description of the module that should be read in conjunction with this EV kit data sheet prior to modifying the demo circuit. For full module features, benefits and parameters, refer to the *MAXM15062* data sheet.

Features

- Highly Integrated Solution
- Wide 5.5V to 48V Input Range
- Fixed 3.3V Output, Delivers Up To 300mA Output Current
- High 80.46% Efficiency ($V_{\text{IN}} = 24\text{V}$, $V_{\text{OUT}} = 3.3\text{V}$ at 150mA)
- 500kHz Switching Frequency
- ENABLE/UVLO Input, Resistor-Programmable UVLO Threshold
- PFM Feature for Better Light-Load Efficiency
- Fixed Internal 4.1ms Soft-Start Time
- RESET Output, with Pullup Resistor to V_{CC}
- Overcurrent and Overtemperature Protection (OCP and OTP)
- Low-Profile, Surface-Mount Components
- Proven PCB Layout
- Fully Assembled and Tested
- Complies with CISPR22(EN55022) Class B Conducted and Radiated Emissions

Quick Start

Recommended Equipment

- One 4.5V to 60V, 300mA power supply
- 1W resistive load with 300mA sink capacity
- Four digital multimeters (DMM)
- MAXM15062EVKIT#

Equipment Setup and Test Procedure

The EV kit is fully assembled and tested. Follow the steps below to verify the board operation.

Caution: Do not turn on power supply until all connections are completed.

- 1) Set the power supply at a voltage between 4.5V and 60V. Then, disable the power supply.
- 2) Connect the positive terminal of the power supply to the VIN PCB pad and the negative terminal to the nearest GND PCB pad. Connect the positive terminal of the 300mA load to the VOUT PCB pad and the negative terminal to the nearest GND PCB pad.
- 3) Connect the DVM (DMM in voltage-measurement mode) across the VOUT PCB pad and the nearest GND PCB pad.
- 4) Verify that shunt is not installed on jumper J1 (see [Table 1](#) for details).
- 5) Turn on the DC power supply.
- 6) Enable the load.
- 7) Verify that the DVM displays 3.3V.

Ordering Information appears at end of data sheet.

MAXM15062 3.3V Output Evaluation Kit

Evaluates: MAXM15062 3.3V Output-Voltage Application

Detailed Description

The MAXM15062 EV kit is designed to demonstrate salient features of MAXM15062 power module. The EV kit includes an EN/UVLO PCB pad, and jumper J1, to enable the output at a desired input voltage. Jumper J2 allows selection of either PWM or PFM mode of operation based on light-load performance requirements. An additional $\overline{\text{RESET}}$ pad is available for monitoring if the converter output voltage is in regulation.

Output Capacitor Selection

X7R ceramic output capacitors are preferred due to their stability over temperature in industrial applications. The required output capacitor (C5) for 3.3V output is selected from Table 1 of the [MAXM15062](#) data sheet as 10 μ F/6.3V.

Fixed Output Voltage

The MAXM15062 is a fixed 3.3V output module. Connect FB of MAXM15062 directly to V_{OUT} for feedback control.

Enable/Undervoltage-Lockout (EN/UVLO) Programming

The MAXM15062 offers an adjustable input undervoltage-lockout feature. In this EV kit, for normal operation, leave jumper J1 open. When J1 is left open, the MAXM15062 is enabled when the input voltage rises above 5.4V. To disable MAXM15062, install a jumper across pins 2-3 on J1. See [Table 1](#) for J1 settings. A potential divider formed by R1 and R2 sets the input voltage (V_{INU}) at which the module is enabled. The value of resistor R1 is chosen to be 2.2M Ω , and R2 is calculated using the following equation:

$$R_2 = \frac{R_1 \times 1.215}{(V_{\text{INU}} - 1.215)}$$

where R1 and R2 are in k Ω ,

For MAXM15062 to turn on at 5.4V input, the Resistor R2 is calculated to be 634k Ω .

Input Capacitor Selection

The input capacitor serves to reduce the current peaks drawn from the input power supply and reduces switching frequency ripple at the input. The input capacitance must be greater than or equal to the value given in [Table 1](#) of [MAXM15062](#) data sheet. Input capacitor C3 is chosen to be 1 μ F/100V.

Electro-Magnetic Interference (EMI)

Compliance to conducted emissions (CE) standards requires an EMI filter at the input of a switching power converter. The EMI filter attenuates high-frequency currents drawn by the switching power converter, and limits the noise injected back into the input power source.

Use of EMI filter components as shown in [Figure 1](#) in conjunction with the schematic results in lower conducted emissions, below CISPR22 Class B limits. The MAXM15062 EV kit PCB layout is also designed to limit radiated emissions from switching nodes of the power converter, resulting in radiated emissions below CISPR22 Class B limits.

Hot-Plug-In and Long Input Cables

The MAXM15062 EV kit PCB provides an optional electrolytic capacitor (C2, 4.7 μ F/100V) to dampen input voltage peaks and oscillations that can arise during hot-plug-in and/or due to long input cables. This capacitor limits the peak voltage at the input of the MAXM15062 power module, when the EV kit is powered directly from a precharged capacitive source or an industrial backplane PCB. Long input cables, between input power source and the EV kit circuit can cause input-voltage oscillations due to the inductance of the cables. The equivalent series resistance (ESR) of the electrolytic capacitor helps damp out the oscillations caused by long input cables. Further, capacitor C1 (0.1 μ F/100V), placed near the input of the board, helps in attenuating high frequency noise.

Table 1. UVLO Enable/Disable Configuration (J1)

POSITION	EN/UVLO PIN	MAXM15062_ OUTPUT
Not Installed*	Connected to the center node of resistor-divider R1 and R2.	Programmed to startup at desired input-voltage level.
1-2	Connected to V_{IN}	Enabled if V_{IN} is greater than $V_{\text{IN(MIN)}}$.
2-3	Connected to GND	Disabled

*Default position

MAXM15062 3.3V Output Evaluation Kit

Evaluates: MAXM15062 3.3V Output-Voltage Application

Mode of Operation

The MAXM15062 features PFM mode of operation to increase the efficiency at light-load condition. If the MODE pin is left unconnected during powerup, the module operates in PFM mode at light loads. If the MODE pin is connected to GND during power-up, the part operates in constant-frequency PWM mode at all loads. See [Table 2](#) for J2 settings.

Internal LDO

An internal regulator provides a 5V nominal supply to power the internal functions of the module. The output of the linear regulator (V_{CC}) should be bypassed with a $1\mu\text{F}$ capacitor C4 to GND.

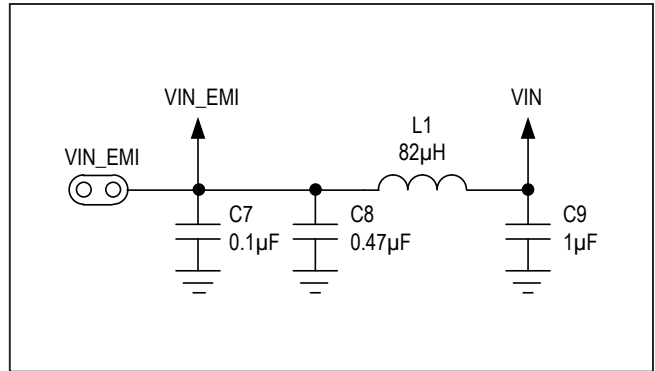

Figure 1. EMI Filter Components

Table 2. Mode of Operation (J2)

POSITION	MODE PIN
1-2	Operates in PWM mode.
Not Installed*	Operates in PFM mode at light-load conditions.

*Default position

EV Kit Performance Report

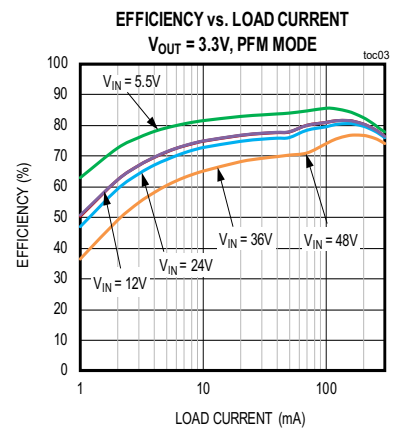
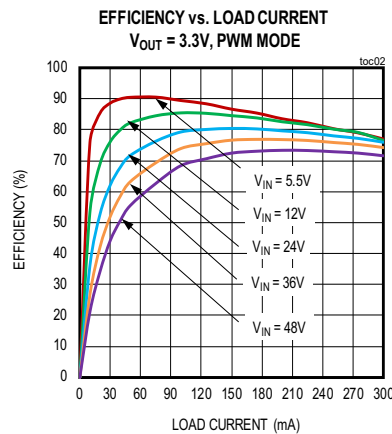
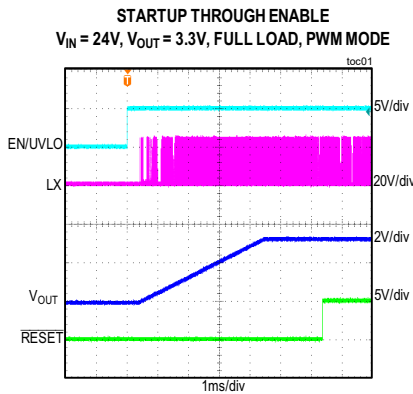

EV Kit Performance Report (continued)

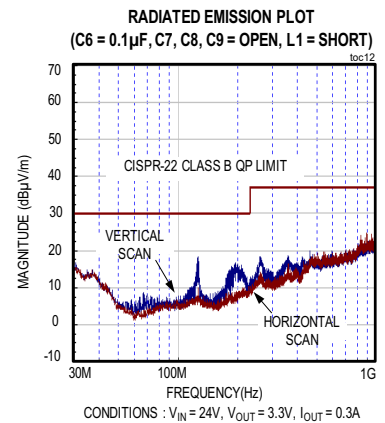
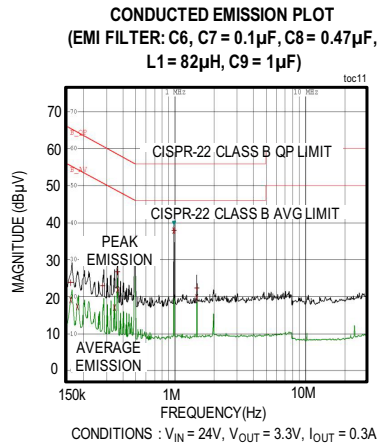
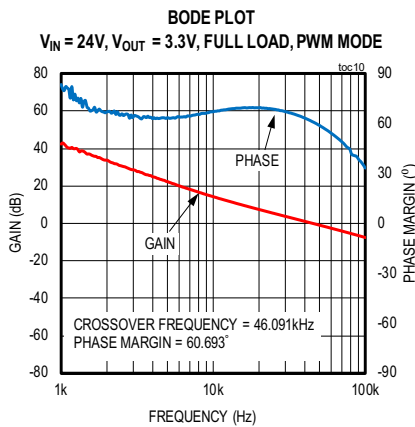
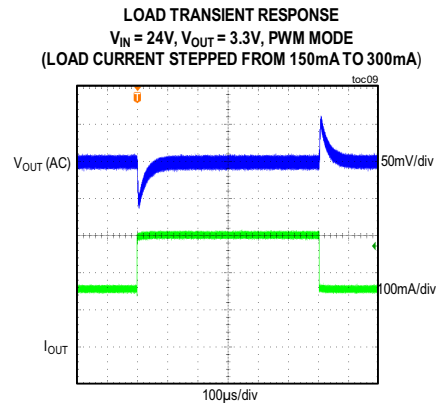
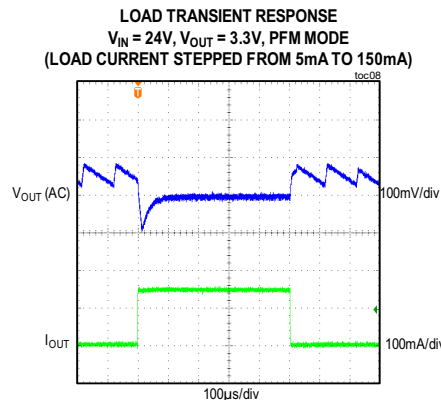
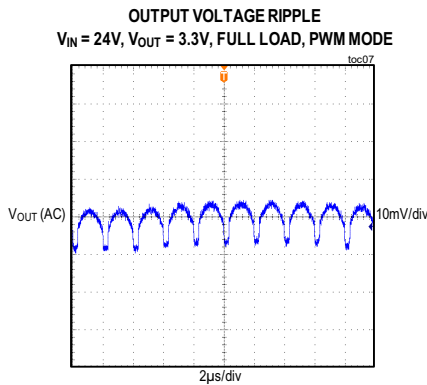
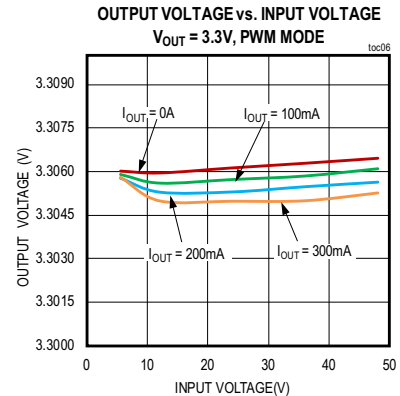
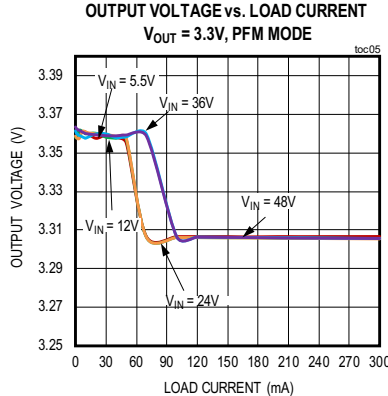
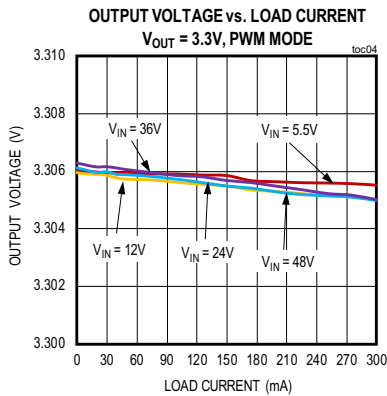

MAXM15062 3.3V Output Evaluation Kit

Evaluates: MAXM15062 3.3V Output-Voltage Application

Ordering Information

PART	TYPE
MAXM15062EVKIT#	EV Kit

#Denotes RoHS compliant.

Component Suppliers

SUPPLIER	WEBSITE
Murata Americas	www.murata.com
NEC TOKIN America, Inc.	www.nec-tokinamerica.com
Panasonic Corp.	www.panasonic.com
SANYO Electric Co., Ltd.	www.sanyodevice.com
TDK Corp.	www.component.tdk.com
TOKO America, Inc.	www.tokoam.com

Note: Indicate that you are using the MAXM15062 when contacting these component suppliers.

MAXM15062 3.3V EV Kit Bill of Materials

ITEM	QTY	DESIGNATION	DESCRIPTION	MANUFACTURER PARTNUMBER-1	MANUFACTURER PARTNUMBER-2
1	1	C1	0.1 μ F \pm 10%, 100V, X7R ceramic capacitor (0603)	MURATA GRM188R72A104KA35	
2	1	C2	4.7 μ F \pm 20%, 100V, Aluminum Capacitor	NICHICON UUR2A4R7MCL6GS	
3	1	C3	1 μ F \pm 10%, 100V, X7R ceramic capacitor (1206)	MURATA GRM31CR72A105KA01L	TDK C3216X7R2A105K160
4	1	C4	1 μ F \pm 10%, 16V, X7R ceramic capacitor (0603)	MURATA GRM188R71C105KA12	TDK C1608X7R1C105K
5	1	C5	10 μ F \pm 10%, 6.3V, X7R ceramic capacitor (1206)	MURATA GRM31CR70J106K	
6	1	C6	OPEN (OPTIONAL : 0.1 μ F \pm 10%, 50V, X7R ceramic capacitor (0603))	Murata GRM188R71H104KA93	
7	1	R1	2.2M Ω \pm 1% resistor (0402)	VISHAY DALE CRCW04022M20FK	
8	1	R2	634k Ω \pm 1% resistor (0402)	VISHAY DALE CRCW0402634KFK	
9	1	R3	100k Ω \pm 1% resistor (0402)	VISHAY DALE CRCW0402100KFK	YAGEO PHICOMP RC0402FR-07100KL
10	1	U1	MAXM15062, 10-pin micro-SLIC Power Module	MAXIM MAXM15062AMB+T	
11	1	L1	OPTIONAL : 82 μ H Shielded Wirewound Inductor(2016)	Murata LQH2MPN820MGRL	
12	1	C7	OPTIONAL : 0.1 μ F \pm 10%, 100V, X7R ceramic capacitor (0603)	MURATA GRM188R72A104KA35	
13	1	C8	OPTIONAL : 0.47 μ F \pm 10%, 100V, X7R ceramic capacitor (1206)	Murata GRM31MR72A474KA35L	
14	1	C9	1 μ F \pm 10%, 100V, X7R ceramic capacitor (1206)	MURATA GRM31CR72A105KA01L	TDK C3216X7R2A105K160

MAXM15062 3.3V EV Kit PCB Layout Diagrams

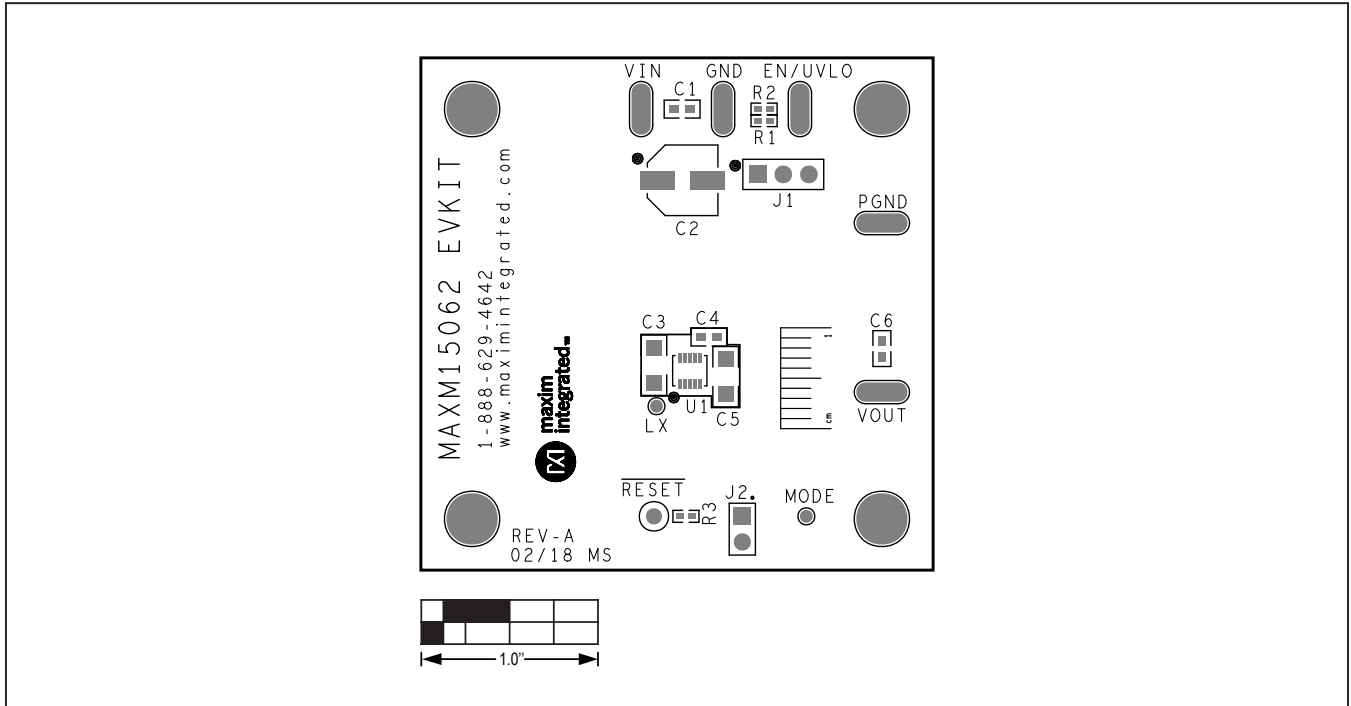

MAXM15062 EV Kit PCB Layout—Silk Top

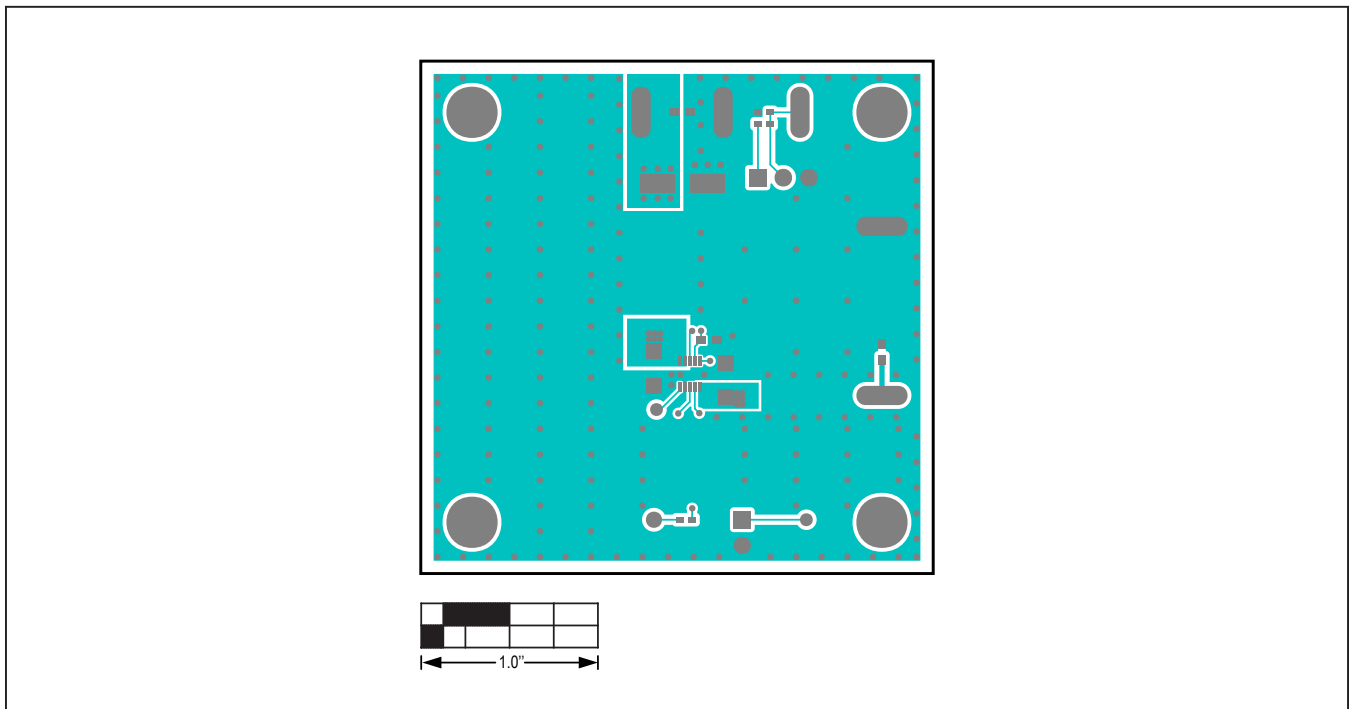

MAXM15062 EV Kit PCB Layout—Top Layer

MAXM15062 3.3V EV Kit PCB Layout Diagrams (continued)

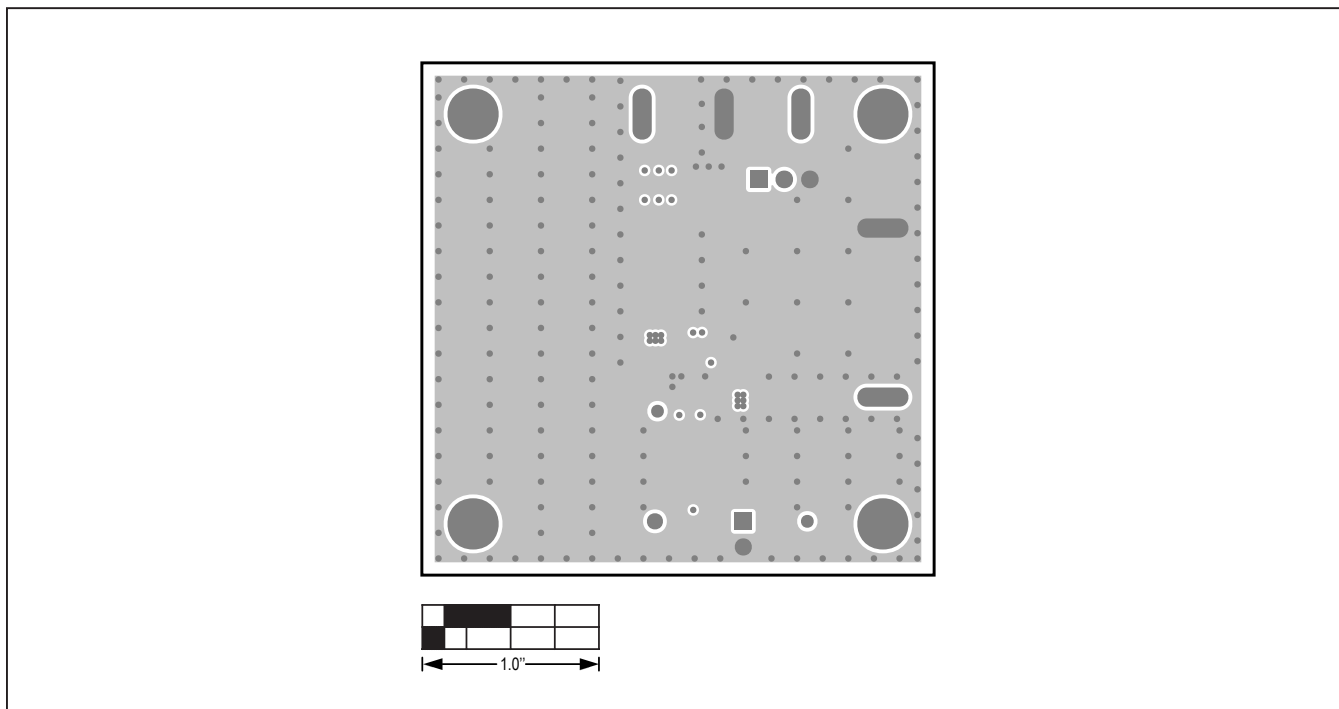

MAXM15062 EV Kit PCB Layout—Layer 2 Ground

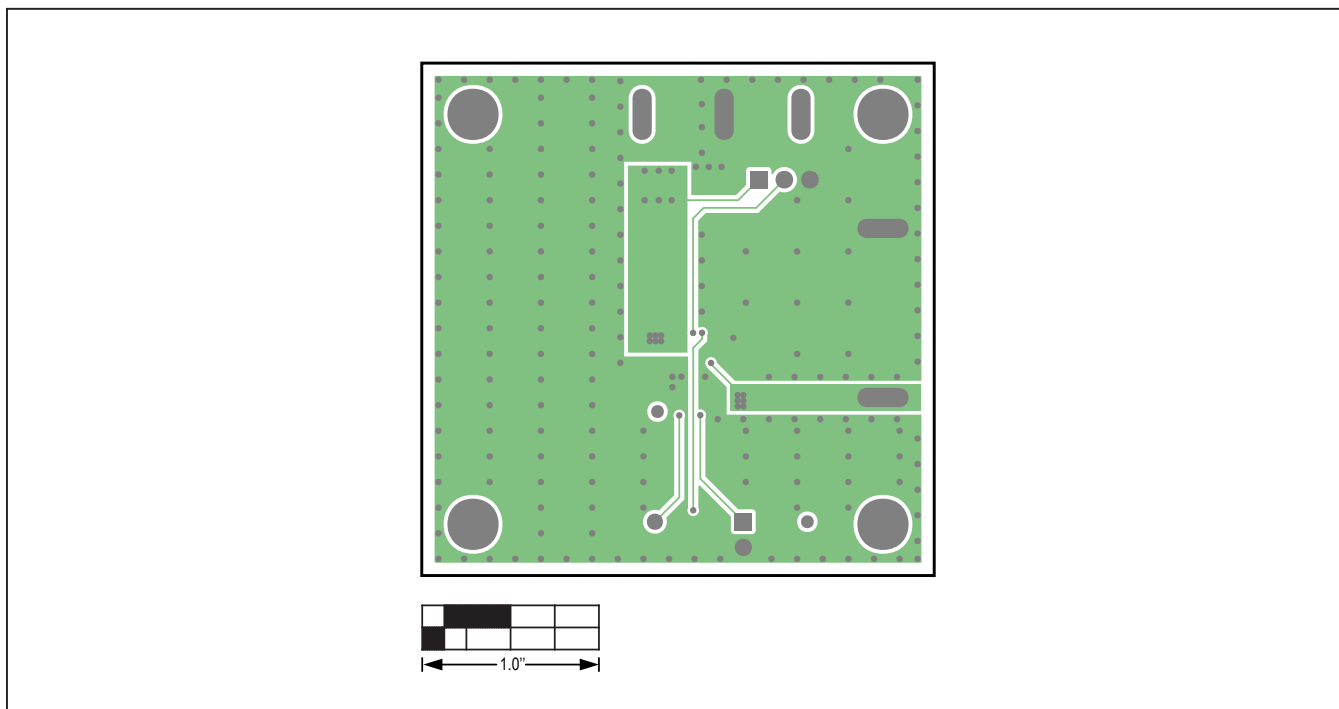

MAXM15062 EV Kit PCB Layout—Layer 3 Power

MAXM15062 3.3V EV Kit PCB Layout Diagrams (continued)

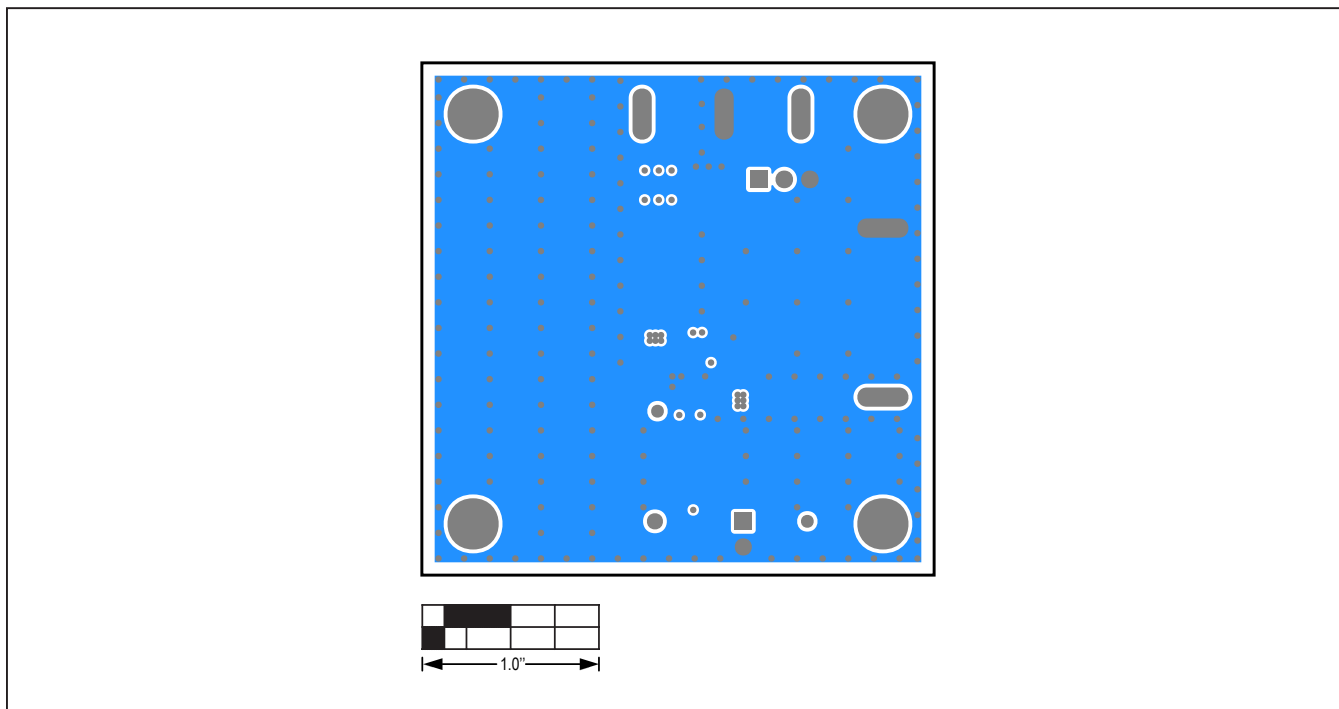

MAXM15062 EV Kit PCB Layout—Bottom Layer

Revision History

REVISION NUMBER	REVISION DATE	DESCRIPTION	PAGES CHANGED
0	3/19	Initial release	—

For pricing, delivery, and ordering information, please visit Maxim Integrated's online storefront at <https://www.maximintegrated.com/en/storefront/storefront.html>.

Maxim Integrated cannot assume responsibility for use of any circuitry other than circuitry entirely embodied in a Maxim Integrated product. No circuit patent licenses are implied. Maxim Integrated reserves the right to change the circuitry and specifications without notice at any time.

X-ON Electronics

Largest Supplier of Electrical and Electronic Components

Click to view similar products for [Power Management IC Development Tools](#) category:

Click to view products by [Maxim](#) manufacturer:

Other Similar products are found below :

[EVB-EP5348UI](#) [MIC23451-AAAYFL EV](#) [MIC5281YMME EV](#) [124352-HMC860LP3E](#) [DA9063-EVAL](#) [ADP122-3.3-EVALZ](#) [ADP130-0.8-EVALZ](#) [ADP130-1.8-EVALZ](#) [ADP1740-1.5-EVALZ](#) [ADP1870-0.3-EVALZ](#) [ADP1874-0.3-EVALZ](#) [ADP199CB-EVALZ](#) [ADP2102-1.25-EVALZ](#) [ADP2102-1.875EVALZ](#) [ADP2102-1.8-EVALZ](#) [ADP2102-2-EVALZ](#) [ADP2102-3-EVALZ](#) [ADP2102-4-EVALZ](#) [AS3606-DB](#) [BQ25010EVM](#) [BQ3055EVM](#) [ISLUSBI2CKIT1Z](#) [LP38512TS-1.8EV](#) [EVAL-ADM1186-1MBZ](#) [EVAL-ADM1186-2MBZ](#) [ADP122UJZ-REDYKIT](#) [ADP166Z-REDYKIT](#) [ADP170-1.8-EVALZ](#) [ADP171-EVALZ](#) [ADP1853-EVALZ](#) [ADP1873-0.3-EVALZ](#) [ADP198CP-EVALZ](#) [ADP2102-1.0-EVALZ](#) [ADP2102-1-EVALZ](#) [ADP2107-1.8-EVALZ](#) [ADP5020CP-EVALZ](#) [CC-ACC-DBMX-51](#) [ATPL230A-EK](#) [MIC23250-S4YMT EV](#) [MIC26603YJL EV](#) [MIC33050-SYHL EV](#) [TPS60100EVM-131](#) [TPS65010EVM-230](#) [TPS71933-28EVM-213](#) [TPS72728YFFEVM-407](#) [TPS79318YEQEVM](#) [UCC28810EVM-002](#) [XILINXPWR-083](#) [LMR22007YMINI-EVM](#) [LP38501ATJ-EV](#)