

Keywords: Santa Fe, MAXREFDES5#, subsystem reference design, analog front end, AFE, industrial sensors, isolated power and data, industrial automation, PLC, medical, MAXREFDESS#, MAXREFDE55#, MAXREFDESS, MAXREFDE55, isolation

SUBSYSTEM BOARD 5561

Santa Fe (MAXREFDES5#): 16-Bit High Accuracy Multi-Input Isolated Analog Front End (AFE)

Jan 11, 2013

Abstract: This document explains how the Santa Fe (MAXREFDES5#) subsystem reference design meets the higher resolution, higher voltage, and isolation needs of industrial control and industrial automation applications. Hardware and firmware design files as well as FFTs and histograms from lab measurements are provided.

On February 28, 2014, the name of MAXREFDES5# was changed from Cupertino to Santa Fe. Maxim made this change in an effort to distinctly identify MAXREFDES5# as a design focused on industrial applications. Other than the name change, the design remains the same, with similar high performance analog functionality.

Introduction

Today's field programmable gate arrays (FPGAs) and microcontrollers with internal analog-to-digital converters (ADCs) are capable of low-resolution and low-voltage analog inputs. However, they fall short on being able to meet the needs of



[More detailed image \(JPG\)](#)

industrial control and industrial automation applications, where isolation, higher resolutions, and higher voltage system solutions are often needed. The Santa Fe (MAXREFDES5#) subsystem reference design is a 16-bit high-accuracy industrial analog front end (AFE) that accepts -10V to +10V, 0 to 10V, and 4–20mA current loop signals with isolated power and data integrated into a small form factor. The Santa Fe design integrates low-noise high-impedance analog buffers (MAX9632); a highly accurate ADC with innovative on-chip attenuation (MAX1301); an ultra-high precision 4.096V voltage reference (MAX6126); 600V_{RMS} data isolation (MAX14850); and isolated/regulated +12V, -12V, and 5V power rails (MAX256/MAX1659). This AFE solution can be used in any application that needs high-accuracy analog-to-digital conversion, but it is mainly targeted for industrial sensors, industrial automation, process control, programmable logic controllers (PLCs), and medical applications.

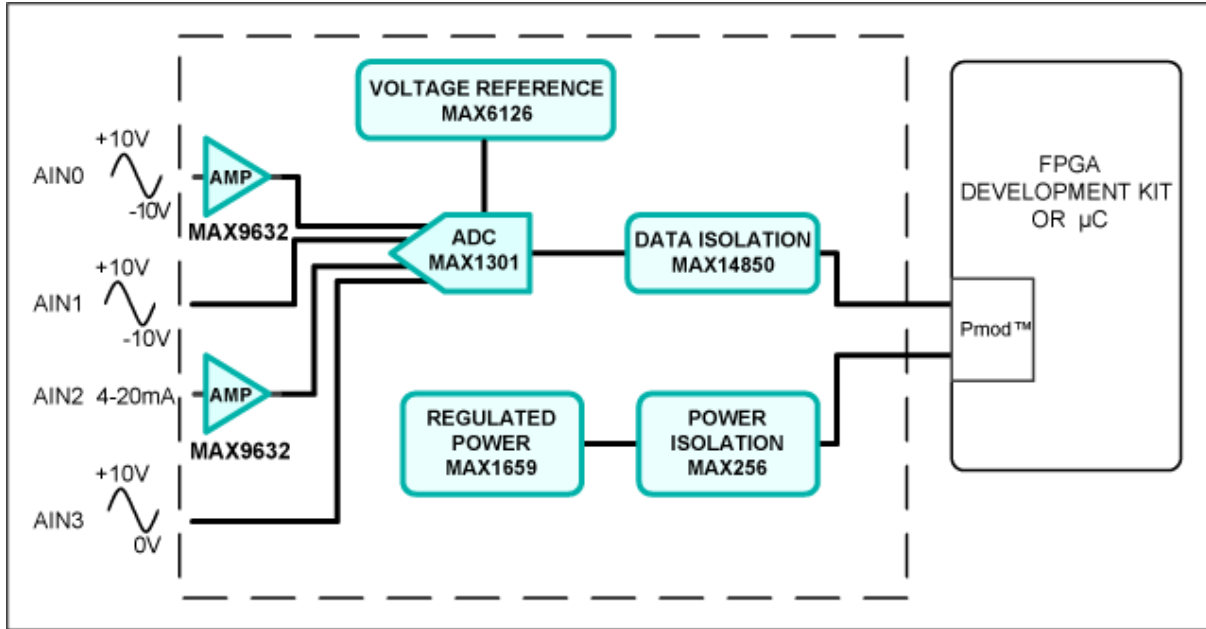

Figure 1. The Santa Fe subsystem design block diagram.

Features

- High accuracy
- $\pm 10\text{V}$, 0 to 10V, and 4–20mA Inputs
- Isolated power and data
- Small printed circuit board (PCB) area
- Device drivers
- Example C source code
- Pmod™-compatible form factor

Applications

- Industrial sensors
- Process control
- Industrial automation
- PLCs
- Medical

Detailed Description of Hardware

The Pmod specification allows for both 3.3V and 5V modules as well as various pin assignments. This module is designed only for a supply voltage of 3.3V and uses the SPI pin assignments as illustrated on the right.

The power requirements are shown in **Table 1**. The currently supported platforms and ports are shown in **Table 2**.

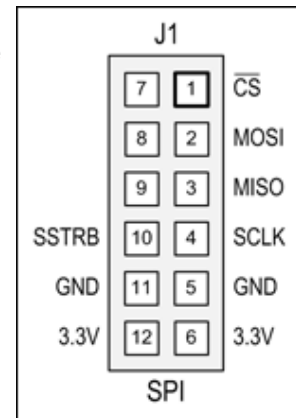

Power Type	Jumper Shunt	Input Voltage (V)	Input Current (mA, typ)
On-board isolated power	JU3: 1-2 JU4: 2-3 JU5: 1-2	3.3	221
External power	JU3: 2-3 JU4: 1-2 JU5: 2-3	3.3	6.3
		+12	30.4
		-12	7.3

Supported Platforms	Ports
Nexys™ 3 platform (Spartan®-6)	JB1
ZedBoard™ platform (Zynq®-7020)	JA1

The Santa Fe hardware design is specifically optimized for applications that use -10V to +10V, 0 to 10V, and 4–20mA signals. Depending on the application requirements, certain portions of the circuit may be omitted. A complete discussion of what portions are needed or may be omitted follows. See the file for the schematic under the [All Design Files](#) section.

The MAX1301 (U3) is a 16-bit, successive-approximation register (SAR) ADC with unique multirange inputs capable of accepting input voltage signals up to +12.288V to -12.288V. The ADC also has integrated analog input buffers with a 17k½ input resistance.

The first MAX9632 amplifier (U1) is optimized for low-noise, -10V to +10V input voltages. The second MAX9632 amplifier (U2) is optimized for low-noise, 4–20mA input currents. Both U1 and U2 provide high input impedance for input signals that have a large source resistance, or in the case of the 4–20mA loop, a 250½ load resistance. Large source resistances often attenuate signals by an undesirable factor. Add an optional 500½ series resistor in front of both MAX9632 amplifiers if input protection is desired while the Santa Fe design is not powered. The 500½ series resistor prevents the input current from exceeding the maximum input current specification when 10V is applied at the input and the Santa Fe board has no power.

If the signal source has a significantly low source resistance compared to 17k½, or in the case of the 4–20mA loop, if the parallel combination of 250½ and 17k½ provides acceptable accuracy in the application, then U1 and U2 can be eliminated. ADC channels AIN1 and AIN3 are examples of using only the internal 17k½ analog input buffers.

Although the MAX1301 ADC has an internal 4.096V voltage reference, for highest accuracy use the external MAX6126 (U4) voltage reference with 0.02% initial accuracy and a 3ppm/°C maximum temperature coefficient (tempco).

The MAX256 (U5) provides an isolated, functional insulation class power solution that accepts 3.3V and converts it to ±12V using an off-the-shelf TGM-H281NF Halo® transformer with a 1:2.6 primary to secondary turns ratio plus an external on-board voltage-doubler circuit. Post-regulation is accomplished using the MAX1659 low dropout (LDO) regulators. The ±12V isolated power solution is optional and is only needed for applications that

require the MAX9632 amplifiers to provide a high input impedance or when power isolation is required. If the MAX9632 amplifiers are not needed, then a single +6V isolated supply can power the entire circuit. Data isolation is also optional depending on the application and is accomplished using the MAX14850 (U9) digital data isolator. The combined power and data isolation achieved is 600V_{RMS}.

Detailed Description of Firmware for Nexys 3 Platform

The Santa Fe firmware design was initially released for the Nexys 3 development kit and targeted a MicroBlaze™ soft core microcontroller placed inside a Xilinx® Spartan-6 FPGA. Support for additional platforms may be added periodically under [Firmware Files](#) in the [All Design Files](#) section. The currently supported platforms and ports are shown in Table 2.

The firmware is a working example of how to interface to the hardware, collect samples, and save them to memory. The simple process flow is shown in **Figure 2a**. The firmware is written in C using the Xilinx SDK tool, which is based on the Eclipse™ open source standard. Custom Santa Fe-specific design functions were created utilizing the standard Xilinx XSpi core version 3.03a. The SPI clock frequency is set to 3.125MHz.

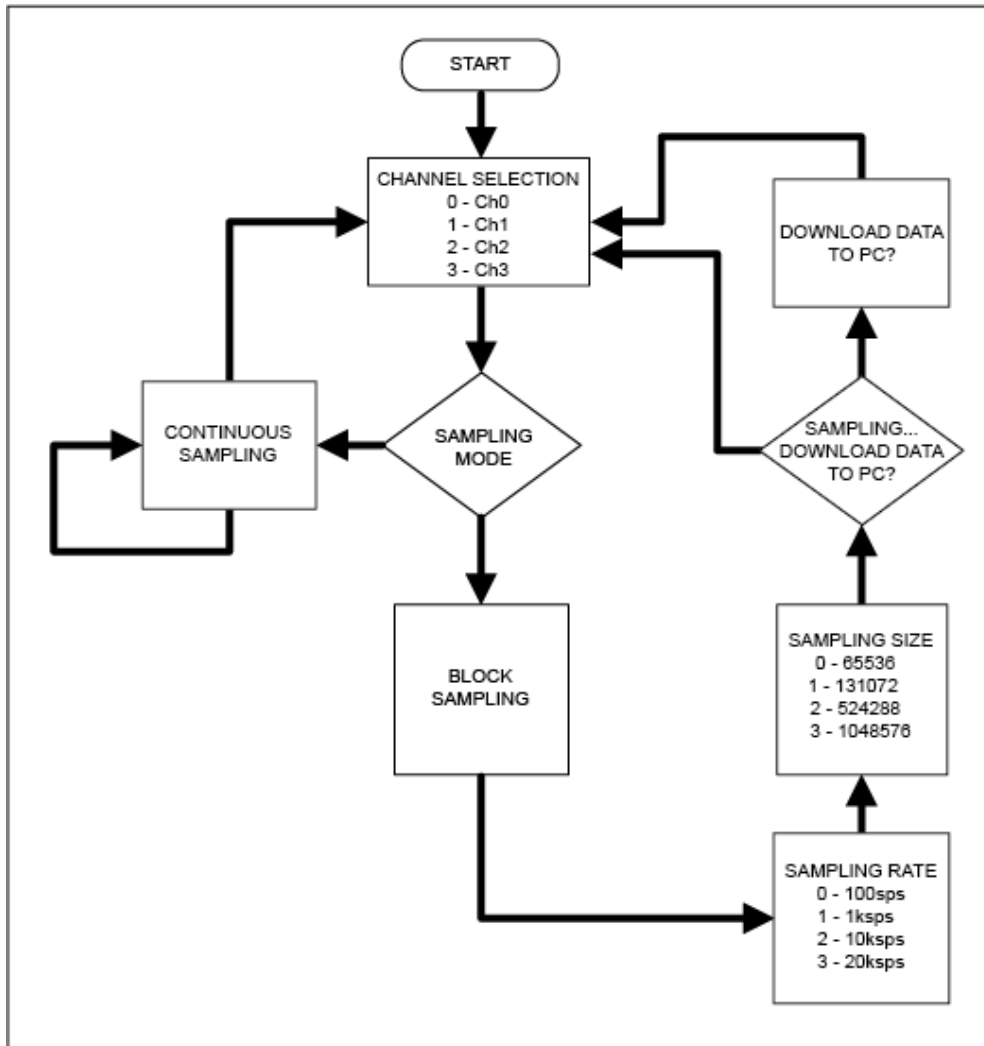

Figure 2a. The Santa Fe firmware flowchart for Nexys 3 platform.

The firmware accepts commands, writes status, and is capable of downloading blocks of sampled data to a standard terminal program via a virtual COM port. The complete source code is provided to speed up customer development. Code documentation can be found in the corresponding firmware platform files.

Detailed Description of Firmware for ZedBoard Platform

The Santa Fe firmware design supports the ZedBoard kit and targets a hardcore ARM® Cortex®-A9 processor inside the Xilinx Zynq system-on-chip (SoC).

The firmware is a working example of how to interface to the hardware, collect samples, and save them to memory. The simple process flow is shown in **Figure 2b**. The firmware is written in C using the Xilinx SDK tool, which is based on the Eclipse open source standard. Custom Santa Fe-specific design functions were created utilizing the ARM's internal SPI peripheral instead of the standard AXI Xilinx XSpi core to increase the maximum sampling rate to 90kps. The SPI clock frequency is set to 3.57MHz.

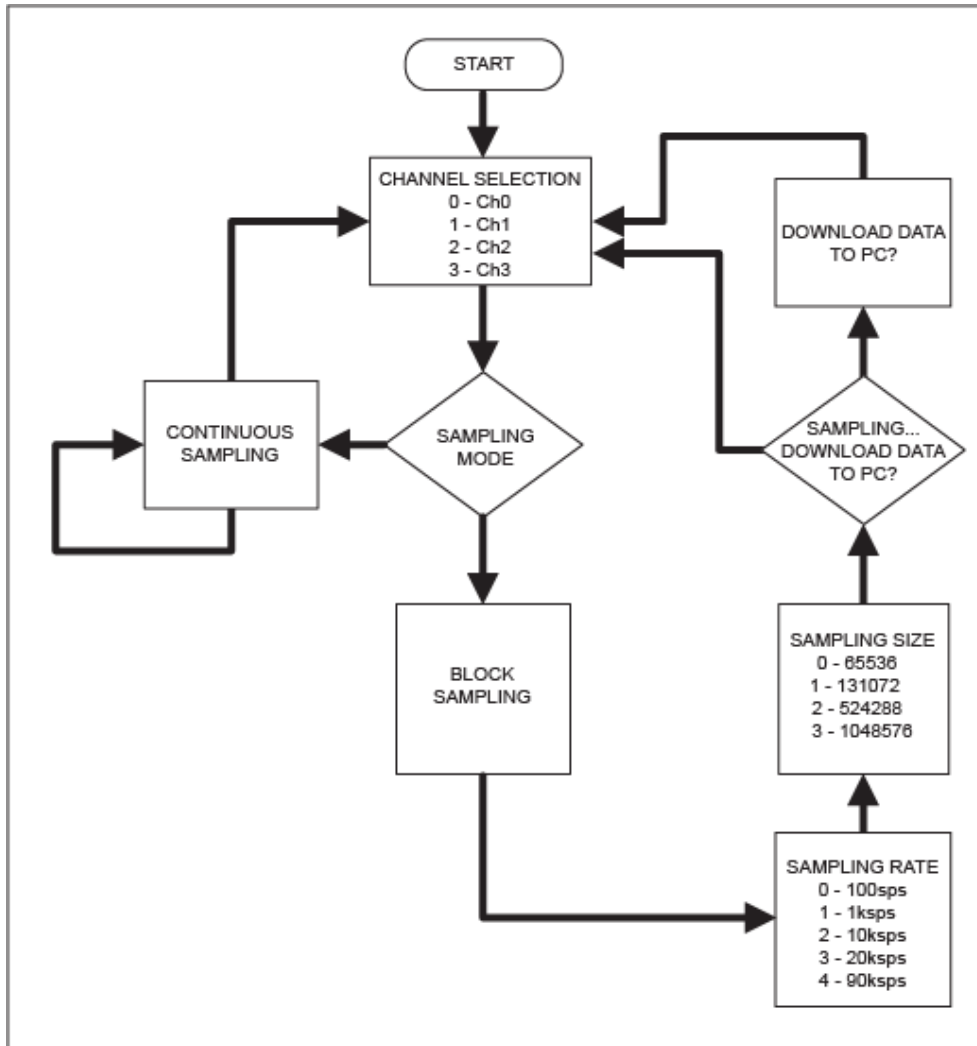

Figure 2b. The Santa Fe firmware flowchart for ZedBoard platform.

The firmware accepts commands, writes status, and is capable of downloading blocks of sampled data to a standard terminal program via a virtual COM port. The complete source code is provided to speed up customer development. Code documentation can be found in the corresponding firmware platform files.

Quick Start

Required equipment:

- Windows® PC with two USB ports
- Santa Fe (MAXREFDES5#) board
- Santa Fe-supported platform (i.e., Nexys 3 development kit or ZedBoard kit)
- Industrial sensor or signal source

Download, read, and carefully follow each step in the appropriate Santa Fe Quick Start Guide:

[Santa Fe \(MAXREFDES5#\) Nexys 3 Quick Start Guide.](#)

[Santa Fe \(MAXREFDES5#\) ZedBoard Quick Start Guide.](#)

Lab Measurements

Equipment used:

- Audio Precision® SYS-2722 signal source or equivalent
- Windows PC with two USB ports
- Santa Fe (MAXREFDES5#) board
- Nexys 3 development kit
- +12V power supply (for external power testing only)
- -12V power supply (for external power testing only)

Special care must be taken and the proper equipment must be used when testing the Santa Fe design. The key to testing any high-accuracy design is to use sources and measurement equipment that are of higher accuracy than the design under test. A low distortion signal source is absolutely required in order to duplicate the results presented below. The input signal was generated using the Audio Precision SYS-2722. The analog inputs should be driven with a source and not be left floating. The FFTs were created using the FFT control in SignalLab from [Mitov Software](#). **Table 3** provides a quick reference for the AC and DC performance of each channel for both on-board isolated power and external power shown in **Figures 3** through **18**. All lab measurements were done at room temperature.

Table 3. Quick Reference Guide for AC Performance (FFTs) or DC Performance (Histograms) in Figures 3 through 18				
Channel	Power Type	Input Type	Test Type	Figure Number
Channel 0 (AIN0)	On-board isolated	±10V, High	AC - FFT	Figure 3
Channel 0 (AIN0)	On-board isolated	±10V, High	DC - histogram	Figure 4
Channel 0 (AIN0)	External	±10V, High	AC - FFT	Figure 5
Channel 0 (AIN0)	External	±10V, High	DC - histogram	Figure 6

Channel 1 (AIN1)	On-board isolated	$\pm 10V$, $17k\frac{1}{2}$	AC - FFT	Figure 7
Channel 1 (AIN1)	On-board isolated	$\pm 10V$, $17k\frac{1}{2}$	DC - histogram	Figure 8
Channel 1 (AIN1)	External	$\pm 10V$, $17k\frac{1}{2}$	AC - FFT	Figure 9
Channel 1 (AIN1)	External	$\pm 10V$, $17k\frac{1}{2}$	DC - histogram	Figure 10
Channel 2 (AIN2)	On-board isolated	4–20mA, $250\frac{1}{2}$	AC - FFT	Figure 11
Channel 2 (AIN2)	On-board Isolated	4–20mA, $250\frac{1}{2}$	DC - histogram	Figure 12
Channel 2 (AIN2)	External	4–20mA, $250\frac{1}{2}$	AC - FFT	Figure 13
Channel 2 (AIN2)	External	4–20mA, $250\frac{1}{2}$	DC - histogram	Figure 14
Channel 3 (AIN3)	On-board isolated	0 to 10V, $17k\frac{1}{2}$	AC - FFT	Figure 15
Channel 3 (AIN3)	On-board isolated	0 to 10V, $17k\frac{1}{2}$	DC - histogram	Figure 16
Channel 3 (AIN3)	External	0 to 10V, $17k\frac{1}{2}$	AC - FFT	Figure 17
Channel 3 (AIN3)	External	0 to 10V, $17k\frac{1}{2}$	DC - histogram	Figure 18

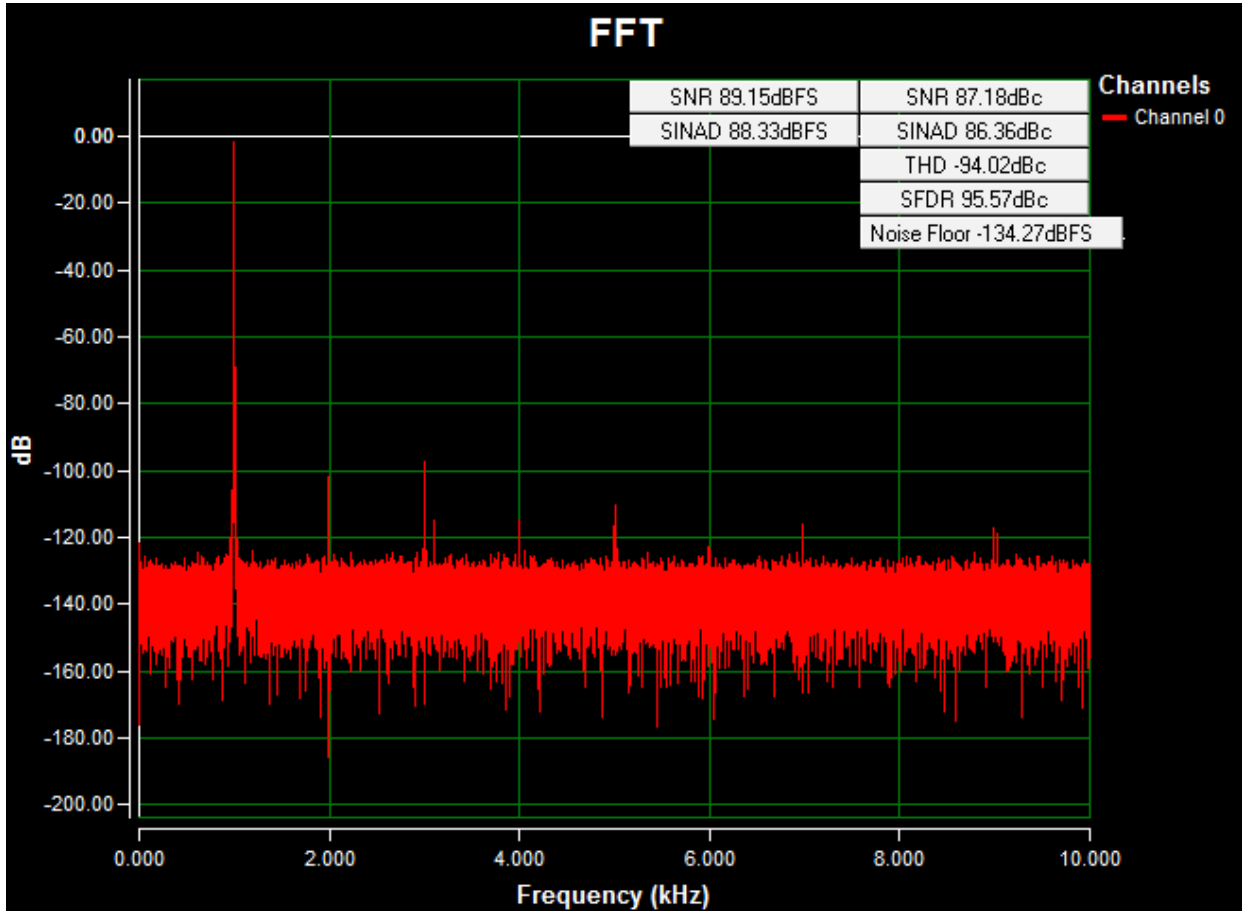

Figure 3. AC FFT for channel 0 (AIN0) using on-board isolated power, a $\pm 10V$ 1kHz sine wave input signal, high-impedance input, a 20ksps sample rate, and a Blackman-Harris window.

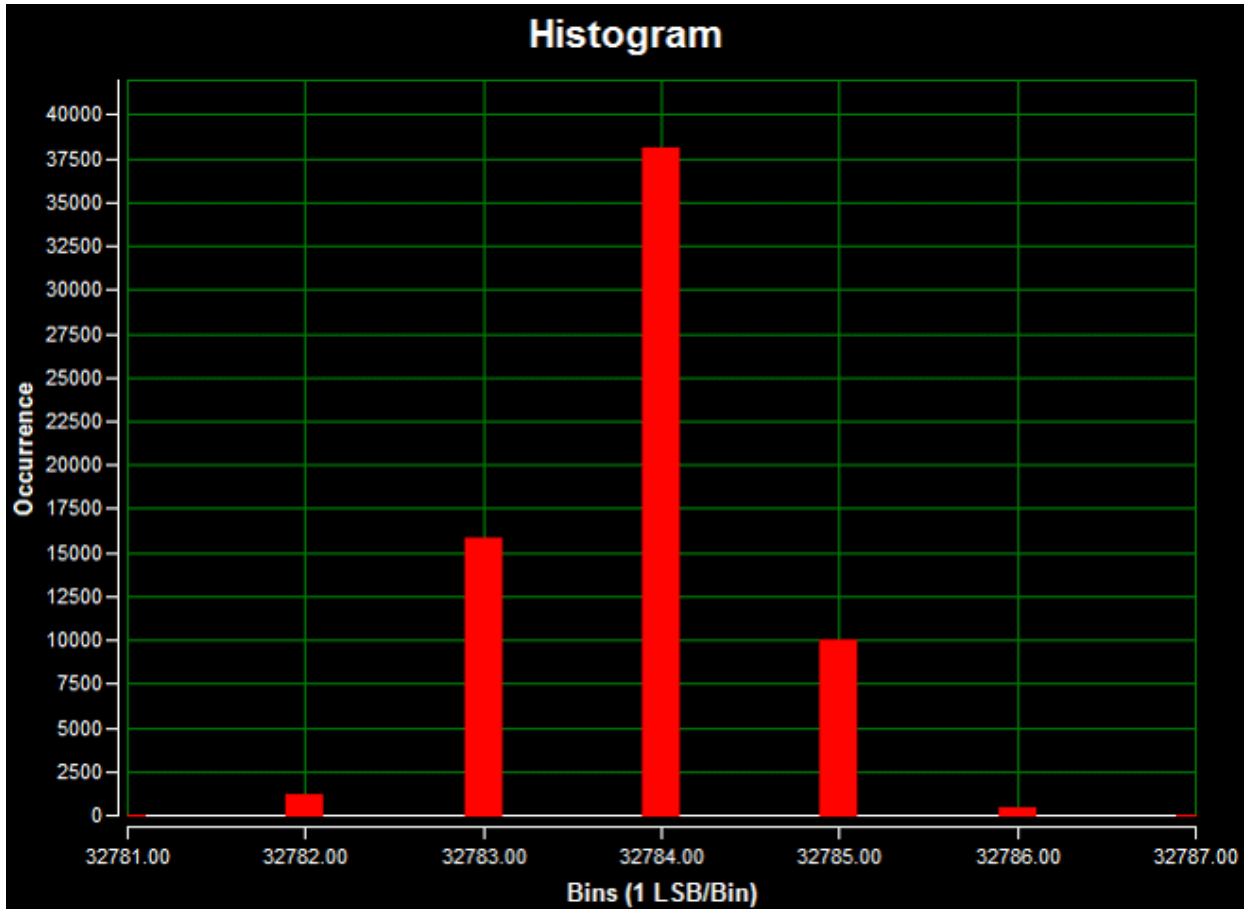

Figure 4. DC histogram for channel 0 (AIN0) using on-board isolated power; a 0V input signal; high-impedance input; a 20ksps sample rate; 65,536 samples; a code spread of 7 LSBs with 97.57% of the codes falling within the three center LSBs; and a standard deviation of 0.693.

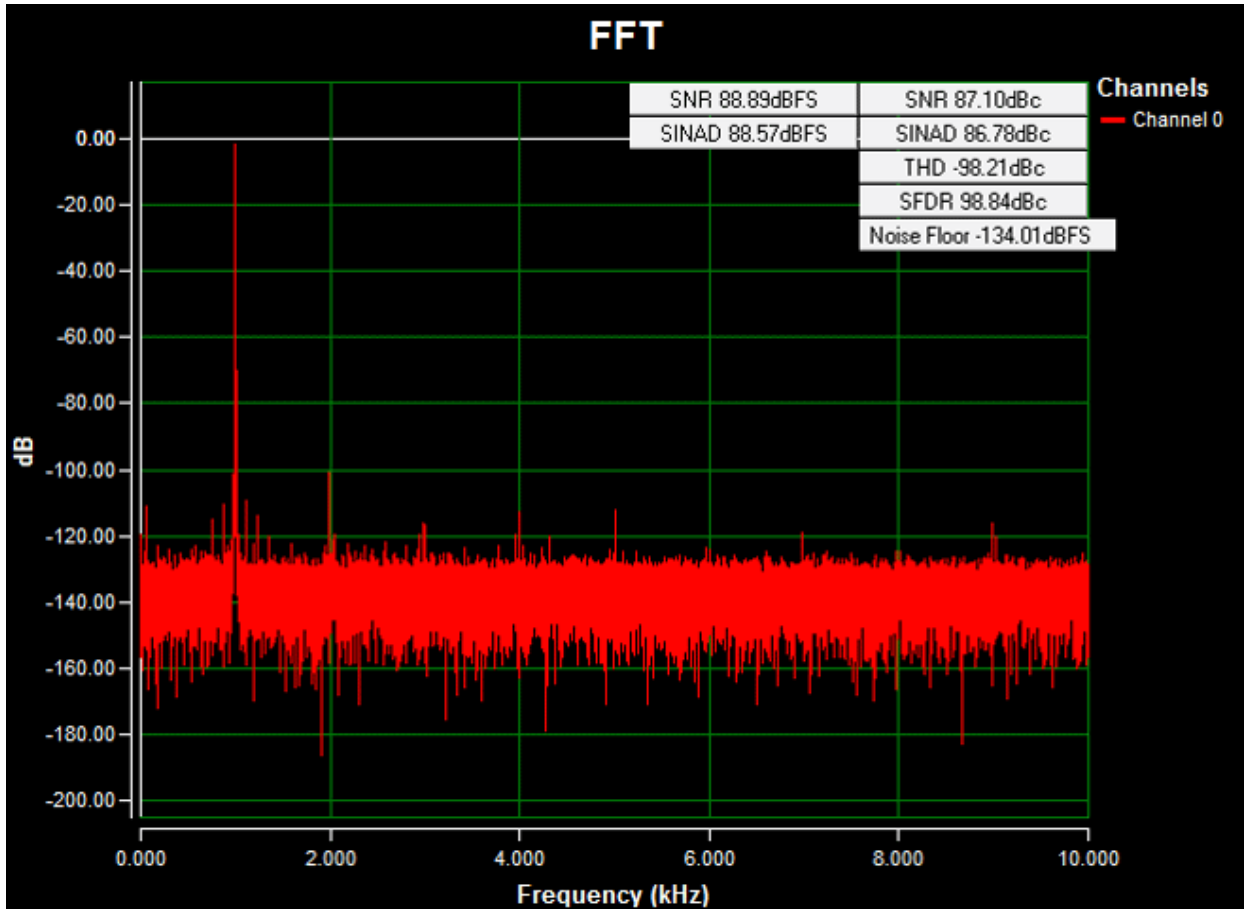

Figure 5. AC FFT for channel 0 (AIN0) using external power, a $\pm 10V$ 1kHz sine wave input signal, high-impedance input, a 20ksps sample rate, and a Blackman-Harris window.

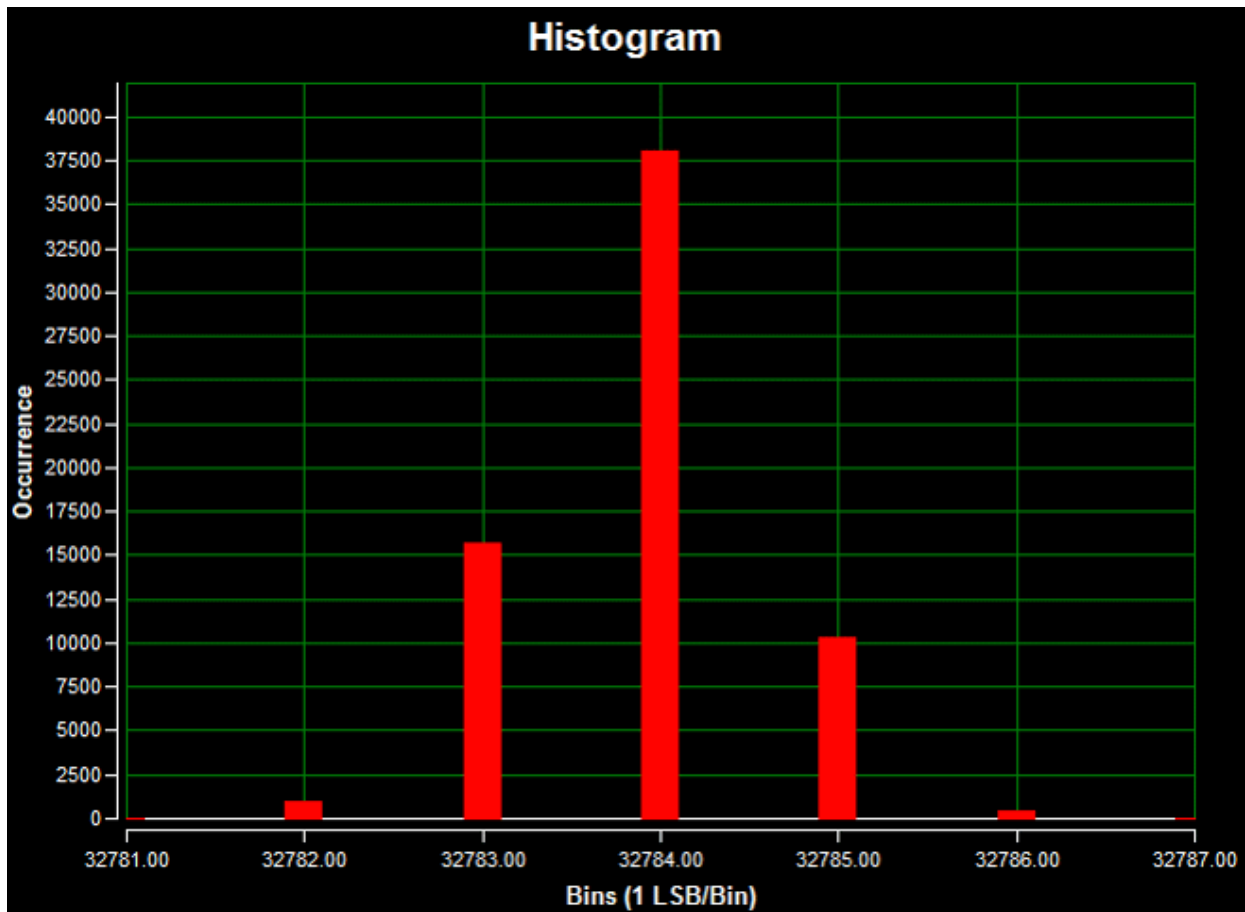

Figure 6. DC histogram for channel 0 (AIN0) using external power; a 0V input signal; high-impedance input; a 20ksps sample rate; 65,536 samples; a code spread of 7 LSBs with 97.74% of the codes falling within the three center LSBs; and a standard deviation of 0.692.

Figures 7 to 10: Channel 1 (AIN1) (PDF)

Figures 11 to 14: Channel 2 (AIN2) (PDF)

Figures 15 to 18: Channel 3 (AIN3) (PDF)

All Design Files

[Download all design files.](#)

Hardware Files

- [Schematic](#)
- [Bill of materials \(BOM\)](#)
- [PCB layout](#)
- [PCB Gerber](#)
- [PCB CAD \(PADS 9.0\)](#)

Firmware Files

[Nexys 3 platform \(Spartan-6\)](#)

[ZedBoard platform \(Zynq-7000\)](#)

Buy Reference Design

[Santa Fe \(MAXREFDES5#\)](#)

ARM is a registered trademark and registered service mark of ARM Limited.

Audio Precision is a registered trademark of Audio Precision, Inc.

Cortex is a registered trademark of ARM Limited.

Eclipse is a trademark of Eclipse Foundation, Inc.

Halo is a registered trademark of Halo Electronics, Inc.

MicroBlaze is a trademark of Xilinx, Inc.

Nexys is a trademark of Digilent Inc.

Pmod is a trademark of Digilent Inc.

Spartan is a registered trademark of Xilinx, Inc.

Windows is a registered trademark and registered service mark of Microsoft Corporation.

Xilinx is a registered trademark and registered service mark of Xilinx, Inc.

ZedBoard is a trademark of ZedBoard.org.

Zynq is a registered trademark of Xilinx, Inc.

Related Parts

MAX1301	8- and 4-Channel, $\pm 3 \times V_{REF}$ Multirange Inputs, Serial 16-Bit ADCs	Free Samples
MAX14850	Six-Channel Digital Isolator	
MAX1659	350mA, 16.5V Input, Low-Dropout Linear Regulators	Free Samples
MAX256	3W Primary-Side Transformer H-Bridge Driver for Isolated Supplies	Free Samples
MAX6126	Ultra-High-Precision, Ultra-Low-Noise, Series Voltage Reference	Free Samples
MAX9632	36V, Precision, Low-Noise, Wide-Band Amplifier	Free Samples
MAXREFDES5	Santa Fe (MAXREFDES5#): 16-Bit High Accuracy Multi-Input Isolated Analog Front End (AFE)	

More Information

For Technical Support: <http://www.maximintegrated.com/support>

For Samples: <http://www.maximintegrated.com/samples>

Other Questions and Comments: <http://www.maximintegrated.com/contact>

Application Note 5561: <http://www.maximintegrated.com/an5561>
SUBSYSTEM BOARD 5561, AN5561, AN 5561, APP5561, Appnote5561, Appnote 5561
© 2013 Maxim Integrated Products, Inc.
Additional Legal Notices: <http://www.maximintegrated.com/legal>

X-ON Electronics

Largest Supplier of Electrical and Electronic Components

Click to view similar products for [Data Conversion IC Development Tools](#) category:

Click to view products by [Maxim](#) manufacturer:

Other Similar products are found below :

[EVAL-AD7265EDZ](#) [EVAL-AD7719EBZ](#) [EVAL-AD7767-1EDZ](#) [EVAL-AD7995EBZ](#) [AD9211-200EBZ](#) [AD9251-20EBZ](#) [AD9251-65EBZ](#)
[AD9613-170EBZ](#) [AD9629-20EBZ](#) [AD9716-DPG2-EBZ](#) [AD9737A-EBZ](#) [AD9993-EBZ](#) [DAC8555EVM](#) [EVAL-AD5061EBZ](#) [EVAL-](#)
[AD5062EBZ](#) [EVAL-AD5443-DBRDZ](#) [EVAL-AD5570SDZ](#) [EVAL-AD7992EBZ](#) [EVAL-AD7994EBZ](#) [AD9119-MIX-EBZ](#) [AD9233-125EBZ](#)
[AD9629-80EBZ](#) [AD9650-80EBZ](#) [AD9767-EBZ](#) [DAC8531EVM](#) [LM96080EB/NOPB](#) [EVAL-AD5445SDZ](#) [EVAL-AD5660EBZ](#) [EVAL-](#)
[AD7685SDZ](#) [EVAL-AD7687SDZ](#) [MAX5318PMB#](#) [MAX1246EVL11-QSOP](#) [MAX117EVKIT-DIP](#) [DC2365A-C](#) [DC2795A-B](#) [DC2795A-A](#)
[DAC088S085EB/NOPB](#) [SIM8909-EVB-KIT](#) [82635ASRCDVKHV 961443](#) [DC1466B-B](#) [EVAL-AD5413SDZ](#) [ADC12D1600RB/NOPB](#) [1083](#)
[RFPDK FOR CMT2X5X](#) [TS7003DB](#) [TSC2014EVM-PDK](#) [MOD-USB3G](#) [KDC5514EVALZ](#) [650201392G](#) [ISL28005FH-100EVAL1Z](#)