

General Description

The SP3222EB and SP3232EB series are RS-232 transceiver solutions intended for portable or hand-held applications such as notebook or laptop computers. The SP3222EB / SP3232EB series has a high-efficiency, charge-pump power supply that requires only 0.1µF capacitors in 3.3V operation. This charge pump allows the SP3222EB / SP3232EB series to deliver true RS-232 performance from a single power supply ranging from 3.0V to 5.5V. The SP3222EB / SP3232EB are 2-driver / 2-receiver devices. The ESD tolerance of the SP3222EB / SP3232E devices is over ±15kV for both Human Body Model and IEC61000-4-2 Air discharge test methods. The SP3222EB device has a low-power shutdown mode where the devices' driver outputs and charge pumps are disabled. During shutdown, the supply current falls to less than 1µA.

Features

- Meets true EIA / TIA-232-F standards from a 3.0V to 5.5V power supply
- 250kbps transmission rate under load
- 1µA low power shutdown with receivers active (SP3222EB)
- Interoperable with RS-232 down to a 2.7V power source
- Enhanced ESD specifications:
 - ±15kV Human Body Model
 - ±15kV IEC61000-4-2 Air Discharge
 - ±8kV IEC61000-4-2 Contact Discharge

Ordering Information - [page 18](#)

Selection Table

Table 1: Selection Table

Device	Power Supplies	RS-232 Drivers	RS-232 Receivers	External Components	Shutdown	TTL 3-State	# of Pins
SP3222EB	3.0V to 5.5V	2	2	4 Capacitors	Yes	Yes	20
SP3232EB	3.0V to 5.5V	2	2	4 Capacitors	No	No	16

Pinouts

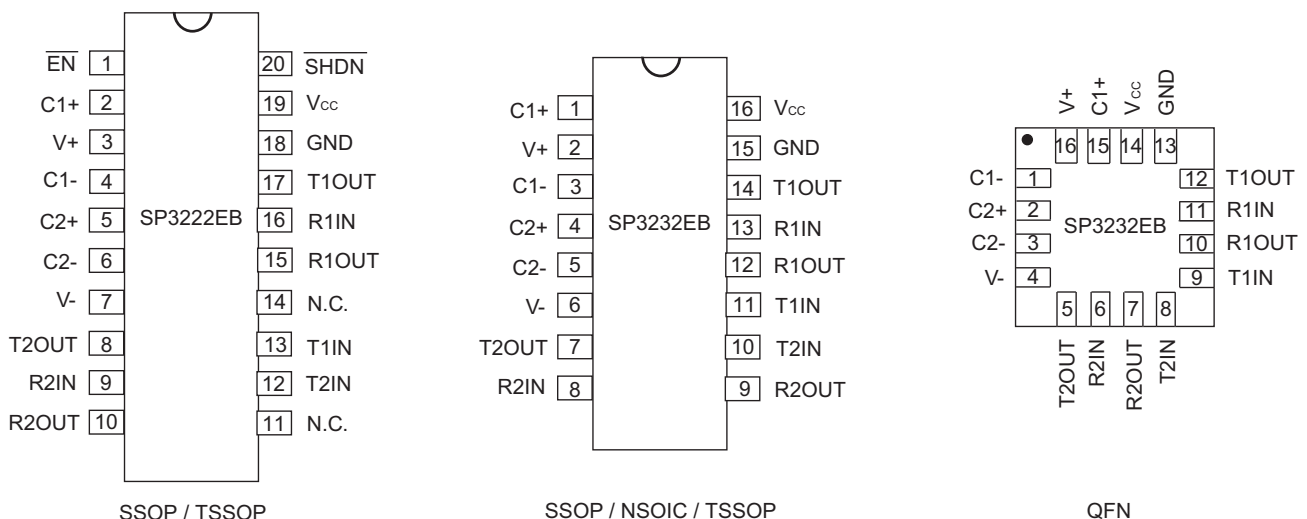

Figure 1: SP3222EB and SP3232EB Pinouts

Revision History

Revision	Release Date	Change Description
--	11/2/05	Legacy Sipex Datasheet
1.0.0	9/9/09	Convert to Exar Format. Update ordering information and change revision to 1.0.0.
1.0.1	6/7/11	Remove obsolete devices per PDN 110510-01 and change ESD rating to IEC-61000-4-2..
1.0.2	3/14/13	Correct ype error to RX input voltage range and TX transition region slew rate condition.
1.0.3	8/14/14	Add Max Junction temperature and package thermal information.
1.0.4	5/28/15	Update Absolute Max Rating for RxIN input voltage to $\pm 25V$, update logo.
1.0.5	10/27/15	Add SP3232EBER (QFN 16) preliminary package option.
1.0.6	2/23/16	Remove preliminary status of QFN 16 package option.
1.0.7	1/24/20	Update to MaxLinear template and logo. Update Ordering Information. Remove obsolete WSOIC references. Move ESD tolerance levels to new ESD Ratings section located on page 1.

Table of Contents

General Description	i
Features	i
Selection Table	i
Pinouts	i
Specifications	1
Absolute Maximum Ratings.....	1
ESD Ratings	1
Operating Conditions.....	2
Electrical Characteristics	2
Typical Performance Characteristics	4
Pin Information	5
Pin Configurations	5
Pin Descriptions	5
Typical Operating Circuits	6
Description	7
Theory of Operation	7
Drivers	7
Receivers	8
Charge Pump	8
ESD Tolerance	10
Mechanical Dimensions	12
SSOP20	12
SSOP16	13
TSSOP16	15
TSSOP20	16
QFN16 5x5	17
Ordering Information	18

List of Figures

Figure 1: SP3222EB and SP3232EB Pinouts	i
Figure 2: Transmitter Output Voltage vs. Load Capacitance.....	4
Figure 3: Slew Rate vs. Load Capacitance.....	4
Figure 4: Supply Current vs. Load Capacitance When Transmitting Data	4
Figure 5: Supply Current vs. Supply Voltage.....	4
Figure 6: Transmitter Output Voltage vs. Supply Voltage.....	4
Figure 7: Pinout Configurations for the SP3222EB and SP3232EB.....	5
Figure 8: SP3222EB Typical Operating Circuit.....	6
Figure 9: SP3232EB Typical Operating Circuit.....	6
Figure 10: SP3222EB / SP3232EB Driver Loopback Test Circuit.....	7
Figure 11: Loopback Test Results at 120kbps	7
Figure 12: Loopback Test Results at 250kbps	8
Figure 13: Charge Pump — Phase 1.....	9
Figure 14: Charge Pump — Phase 2.....	9
Figure 15: Charge Pump Waveforms	9
Figure 16: Charge Pump — Phase 3.....	9
Figure 17: Charge Pump — Phase 4.....	9
Figure 18: ESD Test Circuit for Human Body Model	10
Figure 19: ESD Test Circuit for IEC61000-4-2	10
Figure 20: ESD Test Waveform for IEC61000-4-2	11
Figure 21: Mechanical Dimensions, SSOP20.....	12
Figure 22: Mechanical Dimensions, SSOP16.....	13
Figure 23: Mechanical Dimensions, NSOIC16	14
Figure 24: Mechanical Dimensions, TSSOP16	15
Figure 25: Mechanical Dimensions, TSSOP20	16
Figure 26: Mechanical Dimensions, QFN16 5x5	17

List of Tables

Table 1: Selection Table	i
Table 1: Absolute Maximum Ratings	1
Table 2: ESD Ratings	1
Table 3: Operating Conditions	2
Table 4: Electrical Characteristics	2
Table 5: Pin Descriptions.....	5
Table 6: SP3222EB Truth Table Logic for Shutdown and Enable Control	8
Table 7: Ordering Information.....	18

Specifications

Absolute Maximum Ratings

Important: These are stress ratings only and functional operation of the device at these ratings or any other above those indicated in the operation sections of the specifications below is not implied. Exposure to absolute maximum rating conditions for extended periods of time may affect reliability and cause permanent damage to the device.

Table 1: Absolute Maximum Ratings

Parameter	Minimum	Maximum	Units
V_{CC}	-0.3	6.0	V
$V_{+}^{(1)}$	-0.3	7.0	V
$V_{-}^{(1)}$	-7.0	0.3	V
$V_{+} + V_{-} ^{(1)}$		13	V
I_{CC} (DC V_{CC} or GND current)	-100	100	mA
Input Voltages			
TxIN, \overline{EN}	-0.3	6.0	V
RxIN	-25	25	V
Output Voltages			
TxOUT	-13.2	13.2	V
RxOUT	-0.3	$V_{CC} + 0.3$	V
Short-Circuit Duration			
TxOUT	Continuous		
Temperature			
Storage temperature	-65	150	°C

1. V_{+} and V_{-} can have maximum magnitudes of 7V, but their absolute difference cannot exceed 13V.

2. Driver input hysteresis is typically 250mV.

ESD Ratings

Table 2: ESD Ratings

Parameter		Value	Units
HBM (Human Body Model), driver outputs and receiver inputs		±15	kV
IEC61000-4-2 Air Discharge, driver outputs and receiver inputs	Level 4	±15	kV
IEC61000-4-2 Contact Discharge, driver outputs and receiver inputs	Level 4	±8	kV

Operating Conditions

Table 3: Operating Conditions

Parameter	Value	Units
Temperature		
Maximum junction temperature	125	°C
Power Dissipation Per Package		
20-pin SSOP (derate 9.25mW/°C above 70°C)	750	mW
20-pin TSSOP (derate 11.1mW/°C above 70°C)	890	mW
16-pin SSOP (derate 9.69mW/°C above 70°C)	775	mW
16-pin TSSOP (derate 10.5mW/°C above 70°C)	850	mW
16-pin NSOIC (derate 13.57mW/°C above 70°C)	1086	mW
Thermal Resistance		
16-pin TSSOP Θ_{JA}	100.4	°C/W
16-pin TSSOP Θ_{JC}	19.0	°C/W
16-pin QFN Θ_{JA}	44.0	°C/W
16-pin QFN Θ_{JC}	7.3	°C/W

Electrical Characteristics

Unless otherwise noted, the following specifications apply for $V_{CC} = 3.0V$ to $5.5V$ with $T_{AMB} = T_{MIN}$ to T_{MAX} ,
 $C1 - C4 = 0.1\mu F$.

Table 4: Electrical Characteristics

Parameter	Test Condition	Minimum	Typical	Maximum	Units
DC Characteristics					
Supply current	No load, $V_{CC} = 3.3V$, $T_{AMB} = 25^{\circ}C$, $T_{XIN} = GND$ or V_{CC}		0.3	1.0	mA
Shutdown supply current	$\overline{SHDN} = GND$, $V_{CC} = 3.3V$, $T_{AMB} = 25^{\circ}C$, $T_{XIN} = V_{CC}$ or GND		1.0	10	μA
Logic Inputs and Receiver Outputs					
Input logic threshold LOW	T_{XIN} , \overline{EN} , $\overline{SHDN}^{(1)}$	GND		0.8	V
Input logic threshold HIGH	$V_{CC} = 3.3V^{(1)}$	2.0		V_{CC}	V
Input logic threshold HIGH	$V_{CC} = 5.0V^{(1)}$	2.4		V_{CC}	V
Input leakage current	T_{XIN} , \overline{EN} , \overline{SHDN} , $T_{AMB} = 25^{\circ}C$, $V_{IN} = 0V$ to V_{CC}		± 0.01	± 1.0	μA
Output leakage current	Receivers disabled, $V_{OUT} = 0V$ to V_{CC}		± 0.05	± 10	μA
Output voltage LOW	$I_{OUT} = 1.6mA$			0.4	V
Output voltage HIGH	$I_{OUT} = -1.0mA$	$V_{CC} - 0.6$	$V_{CC} - 0.1$		V
Driver Outputs					

Table 4: (Continued) Electrical Characteristics

Parameter	Test Condition	Minimum	Typical	Maximum	Units
Output voltage swing	All driver outputs loaded with 3k Ω to GND, T _{AMB} = 25°C	±5.0	±5.4		V
Output resistance	V _{CC} = V+ = V- = 0V, to V _{OUT} = ±2V	300			Ω
Output Short-circuit current	V _{OUT} = 0V		±35	±60	mA
Output leakage current	V _{CC} = 0V or 3.0V to 5.5V, V _{OUT} = ±12V, drivers disabled			±25	μ A
Receiver Inputs					
Input voltage range		-15		15	V
Input threshold LOW	V _{CC} = 3.3V	0.6	1.2		V
Input threshold LOW	V _{CC} = 5.0V	0.8	1.5		V
Input threshold HIGH	V _{CC} = 3.3V		1.5	2.4	V
Input threshold HIGH	V _{CC} = 5.0V		1.8	2.4	V
Input hysteresis			0.3		V
Input resistance		3	5	7	k Ω
Timing Characteristics					
Maximum data rate	R _L = 3k Ω , C _L = 1000pF, one driver active	250			kbps
Receiver propagation delay, t _{PHL}	Receiver input to receiver output, C _L = 150pF		0.15		μ s
Receiver propagation delay, t _{PLH}	Receiver input to receiver output, C _L = 150pF		0.15		μ s
Receiver output enable time			200		ns
Receiver output disable time			200		ns
Driver skew	t _{PHL} - t _{PLH} , T _{AMB} = 25°C		100		ns
Receiver skew	t _{PHL} - t _{PLH}		50		ns
Transition-region slew rate	V _{CC} = 3.3V, R _L = 3k Ω , C _L = 1000pF, T _{AMB} = 25°C, measurements taken from -3.0V to +3.0V or +3.0V to -3.0V			30	V/ μ s

1. Driver input hysteresis is typically 250mV.

Typical Performance Characteristics

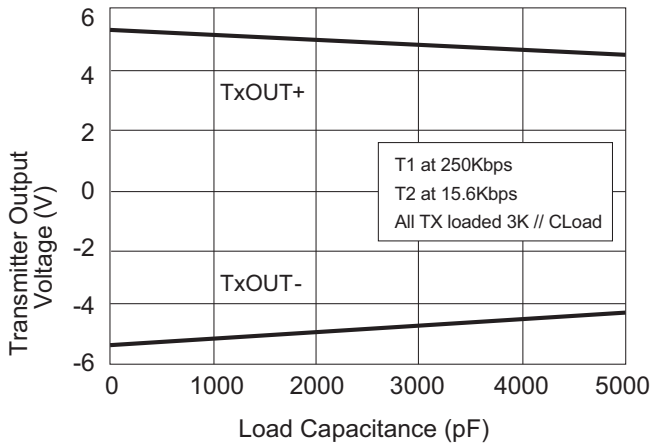

Figure 2: Transmitter Output Voltage vs. Load Capacitance

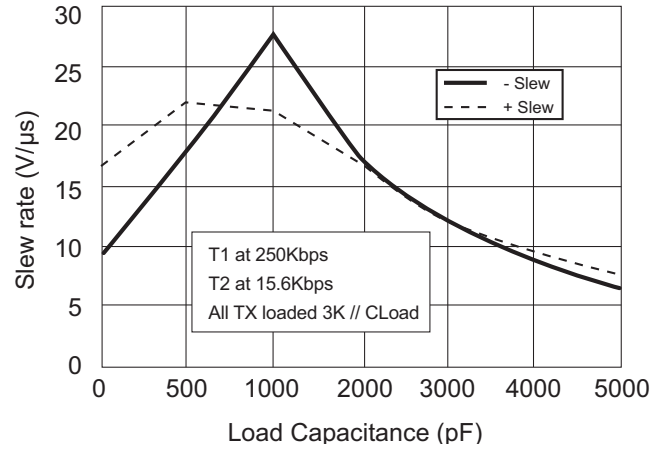

Figure 3: Slew Rate vs. Load Capacitance

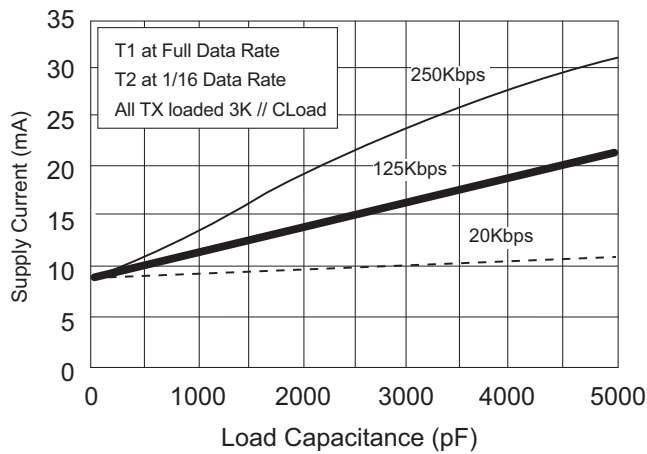

Figure 4: Supply Current vs. Load Capacitance When Transmitting Data

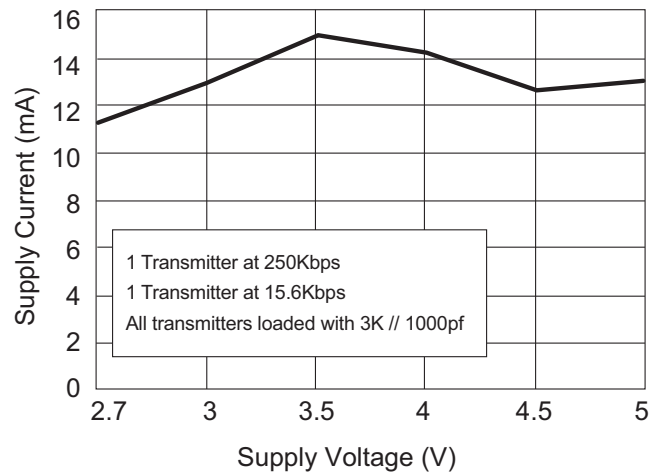

Figure 5: Supply Current vs. Supply Voltage

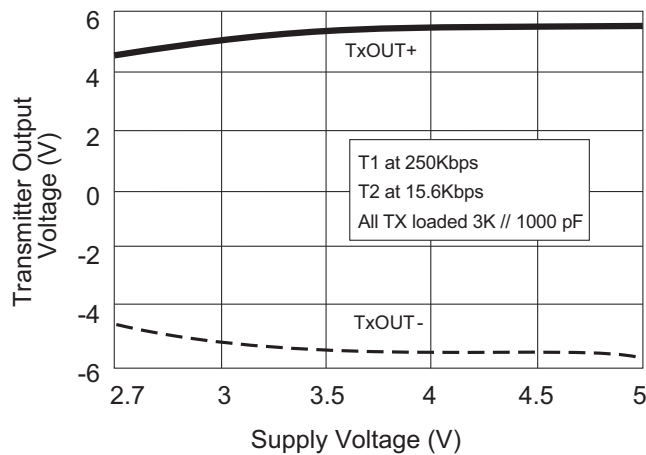

Figure 6: Transmitter Output Voltage vs. Supply Voltage

Pin Information

Pin Configurations

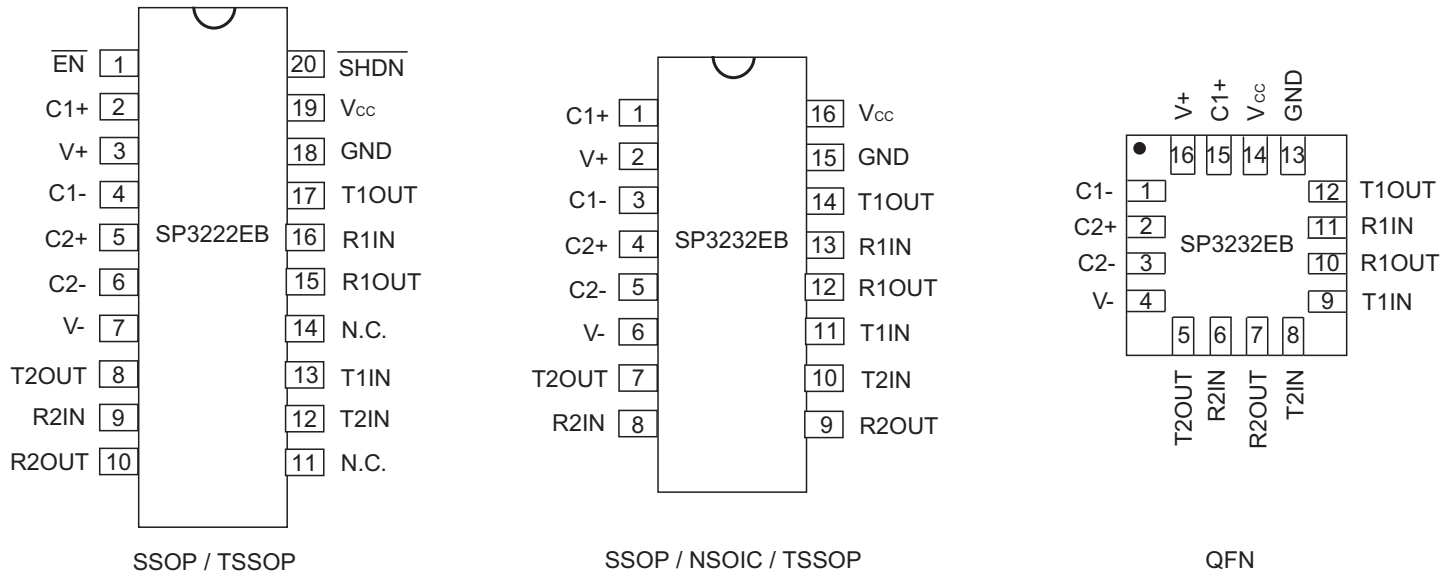

Figure 7: Pinout Configurations for the SP3222EB and SP3232EB

Pin Descriptions

Table 5: Pin Descriptions

Pin Name	Function / Description	Pin Number		
		SP3222EB	SP3232EB	
		SSOP TSSOP	SSOP TSSOP NSOIC	QFN
EN	Receiver enable. Apply logic LOW for normal operation. Apply logic HIGH to disable the receiver outputs (high-Z state).	1	-	-
C1+	Positive terminal of the voltage doubler charge-pump capacitor.	2	1	15
V+	5.5V output generated by the charge pump.	3	2	16
C1-	Negative terminal of the voltage doubler charge-pump capacitor.	4	3	1
C2+	Positive terminal of the inverting charge-pump capacitor.	5	4	2
C2-	Negative terminal of the inverting charge-pump capacitor.	6	5	3
V-	-5.5V output generated by the charge pump.	7	6	4
T ₁ OUT	RS-232 driver output.	17	14	12
T ₂ OUT	RS-232 driver output.	8	7	5
R ₁ IN	RS-232 receiver input.	16	13	11
R ₂ IN	RS-232 receiver input.	9	8	6
R ₁ OUT	TTL / CMOS receiver output.	15	12	10

Description

The SP3222EB / SP3232EB transceivers meet the EIA / TIA-232 and ITU-T V.28/V.24 communication protocols and can be implemented in battery-powered, portable, or hand-held applications such as notebook or palmtop computers. The SP3222EB / SP3232EB devices feature MaxLinear’s proprietary on-board charge pump circuitry that generates $\pm 5.5V$ for RS-232 voltage levels from a single 3.0V to 5.5V power supply. This series is ideal for 3.3V-only systems, mixed 3.3V to 5.5V systems, or 5.0V-only systems that require true RS-232 performance. The SP3222EB / SP3232EB devices can operate at a data rate of 250kbps when fully loaded.

The SP3222EB and SP3232EB are 2-driver / 2-receiver devices ideal for portable or hand-held applications. The SP3222EB features a 1 μA shutdown mode that reduces power consumption and extends battery life in portable systems. Its receivers remain active in shutdown mode, allowing external devices such as modems to be monitored using only 1 μA supply current.

Theory of Operation

The SP3222EB/SP3232EB series is made up of three basic circuit blocks:

1. Drivers
2. Receivers
3. The MaxLinear proprietary charge pump

Drivers

The drivers are inverting level transmitters that convert TTL or CMOS logic levels to 5.0V EIA / TIA-232 levels with an inverted sense relative to the input logic levels. Typically, the RS-232 output voltage swing is $\pm 5.4V$ with no load and $\pm 5V$ minimum fully loaded. The driver outputs are protected against infinite short-circuits to ground without degradation in reliability. Driver outputs will meet EIA / TIA-562 levels of $\pm 3.7V$ with supply voltages as low as 2.7V.

The drivers can guarantee a data rate of 250kbps fully loaded with 3k Ω in parallel with 1000pF, ensuring compatibility with PC-to-PC communication software.

The slew rate of the driver is internally limited to a maximum of 30V/ μs in order to meet the EIA standards (EIA RS-232D 2.1.7, Paragraph 5). The transition of the loaded output from HIGH to LOW also meet the monotonicity requirements of the standard.

Figure 10 shows a loopback test circuit used to test the RS-232 Drivers. Figure 11 shows the test results of the loopback circuit with all drivers active at 120kbps with RS-232 loads in parallel with a 1000pF capacitor. Figure 12 shows the test results where one driver was active at 250kbps and all drivers loaded with an RS-232 receiver in parallel with 1000pF capacitors. A solid RS-232 data transmission rate of 250kbps provides compatibility with many designs in personal computer peripherals and LAN applications.

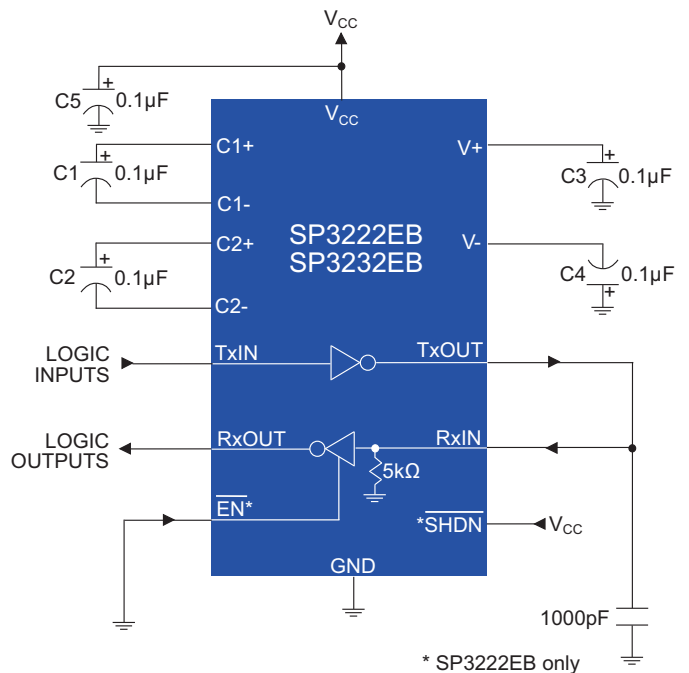

Figure 10: SP3222EB / SP3232EB Driver Loopback Test Circuit

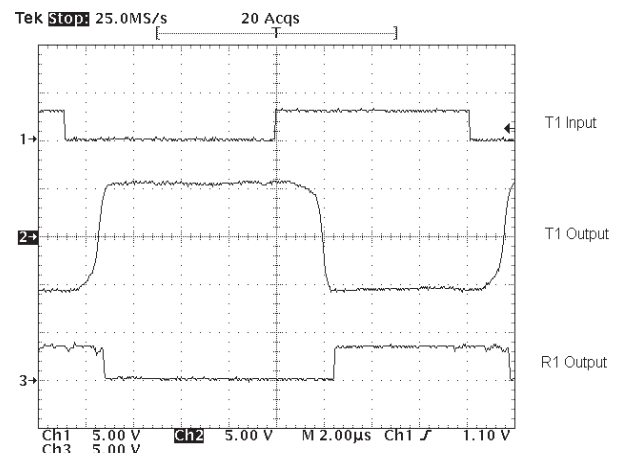

Figure 11: Loopback Test Results at 120kbps

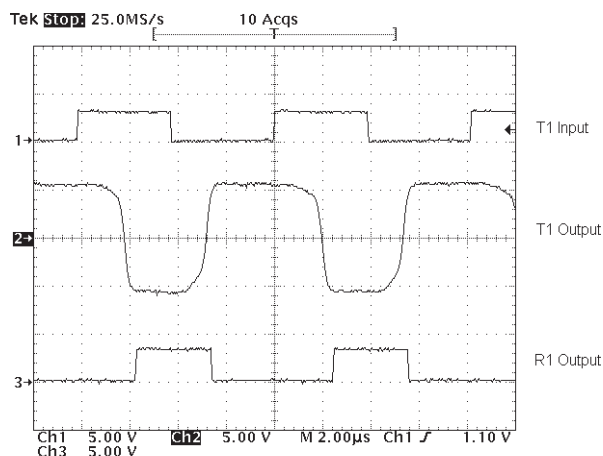

Figure 12: Loopback Test Results at 250kbps

The SP3222EB driver's output stages are turned off (tri-state) when the device is in shutdown mode. When the power is off, the SP3222EB device permits the outputs to be driven up to $\pm 12V$. The driver's inputs do not have pull-up resistors. Designers should connect unused inputs to V_{CC} or GND.

In the shutdown mode, the supply current falls to less than $1\mu A$, where $\overline{SHDN} = \text{LOW}$. When the SP3222EB device is shut down, the device's driver outputs are disabled (tri-stated) and the charge pumps are turned off with $V+$ pulled down to V_{CC} and $V-$ pulled to GND. The time required to exit shutdown is typically $100\mu s$. Connect \overline{SHDN} to V_{CC} if the shutdown mode is not used.

Receivers

The receivers convert EIA / TIA-232 levels to TTL or CMOS logic output levels. The SP3222EB receivers have an inverting tri-state output. These receiver outputs (RxOUT) are tri-stated when the enable control $\overline{EN} = \text{HIGH}$. In the shutdown mode, the receivers can be active or inactive. \overline{EN} has no effect on TxOUT. The truth table logic of the SP3222EB driver and receiver outputs can be found in Table 6.

Table 6: SP3222EB Truth Table Logic for Shutdown and Enable Control

\overline{SHDN}	\overline{EN}	TxOUT	RxOUT
0	0	Tri-state	Active
0	1	Tri-state	Tri-state
1	0	Active	Active
1	1	Active	Tri-state

Since receiver input is usually from a transmission line where long cable lengths and system interference can degrade the signal, the inputs have a typical hysteresis margin of 300mV. This ensures that the receiver is virtually immune to noisy transmission lines. Should an input be left unconnected, an internal $5k\Omega$ pulldown resistor to ground will commit the output of the receiver to a HIGH state.

Charge Pump

The charge pump is an MaxLinear-patented design (U.S. 5,306,954) and uses a unique approach compared to older less-efficient designs. The charge pump still requires four external capacitors, but uses a four-phase voltage shifting technique to attain symmetrical 5.5V power supplies. The internal power supply consists of a regulated dual charge pump that provides output voltages of $\pm 5.5V$ regardless of the input voltage (V_{CC}) over the 3.0V to 5.5V range.

In most circumstances, decoupling the power supply can be achieved adequately using a $0.1\mu F$ bypass capacitor at C5 (refer to Figure 8 and Figure 9).

In applications that are sensitive to power-supply noise, decouple V_{CC} to ground with a capacitor of the same value as charge-pump capacitor C1. Physically connect bypass capacitors as close to the IC as possible.

The charge pump operates in a discontinuous mode using an internal oscillator. If the output voltages are less than a magnitude of 5.5V, the charge pump is enabled. If the output voltages exceed a magnitude of 5.5V, the charge pump is disabled. This oscillator controls the four phases of the voltage shifting. A description of each phase follows.

Phase 1: V_{SS} charge storage

During this phase of the clock cycle, the positive side of capacitors C_1 and C_2 are initially charged to V_{CC} . C_1^+ is then switched to GND and the charge in C_1^- is transferred to C_2^- . Since C_2^+ is connected to V_{CC} , the voltage potential across capacitor C_2 is now 2 times V_{CC} .

Phase 2: V_{SS} transfer

Phase two of the clock connects the negative terminal of C_2 to the V_{SS} storage capacitor and the positive terminal of C_2 to GND. This transfers a negative generated voltage to C_3 . This generated voltage is regulated to a minimum voltage of $-5.5V$. Simultaneous with the transfer of the voltage to C_3 , the positive side of capacitor C_1 is switched to V_{CC} and the negative side is connected to GND.

Phase 3: V_{DD} charge storage

The third phase of the clock is identical to the first phase; the charge transferred in C_1 produces $-V_{CC}$ in the negative terminal of C_1 , which is applied to the negative side of capacitor C_2 . Since C_2^+ is at V_{CC} , the voltage potential across C_2 is 2 times V_{CC} .

Phase 4: V_{DD} transfer

The fourth phase of the clock connects the negative terminal of C_2 to GND, and transfers this positive generated voltage across C_2 to C_4 , the V_{DD} storage capacitor. This voltage is regulated to 5.5V. At this voltage, the internal oscillator is disabled. Simultaneous with the transfer of the voltage to C_4 , the positive side of capacitor C_1 is switched to V_{CC} and the negative side is connected to GND, allowing the charge pump cycle to begin again. The charge pump cycle will continue as long as the operational conditions for the internal oscillator are present.

Since both $V+$ and $V-$ are separately generated from V_{CC} , in a no-load condition $V+$ and $V-$ will be symmetrical. Older charge pump approaches that generate $V-$ from $V+$ will show a decrease in the magnitude of $V-$ compared to $V+$ due to the inherent inefficiencies in the design.

The clock rate for the charge pump typically operates at greater than 250kHz. The external capacitors can be as low as 0.1 μ F with a 16V breakdown voltage rating.

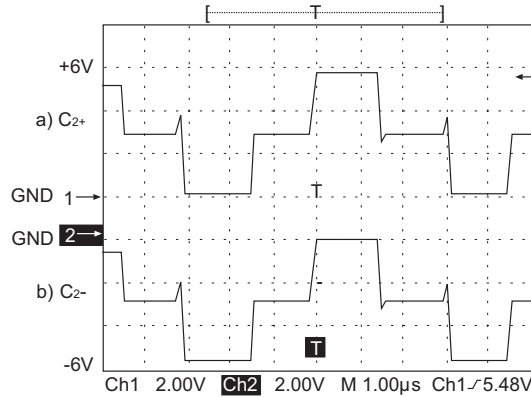

Figure 15: Charge Pump Waveforms

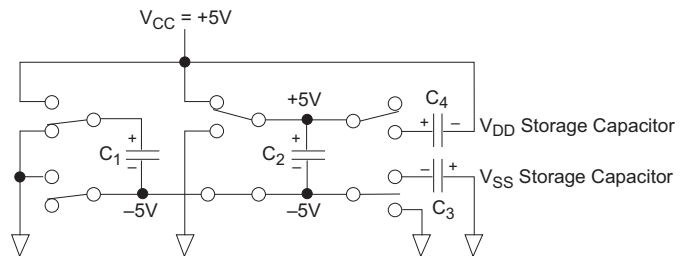

Figure 16: Charge Pump — Phase 3

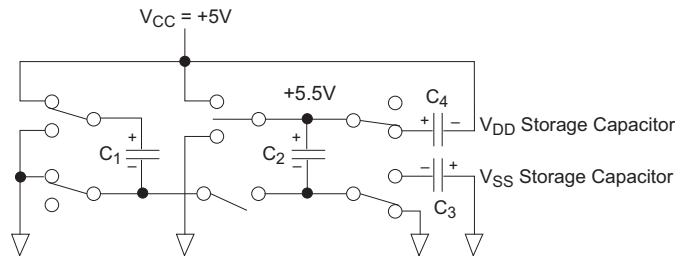

Figure 17: Charge Pump — Phase 4

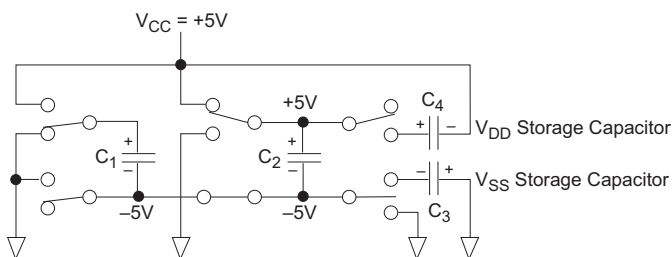

Figure 13: Charge Pump — Phase 1

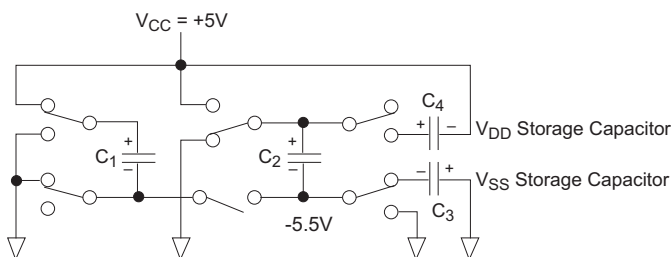

Figure 14: Charge Pump — Phase 2

ESD Tolerance

The SP3222EB / SP3232EB Series incorporates ruggedized ESD cells on all driver output and receiver input pins. The ESD structure is improved over our previous family for more rugged applications and environments sensitive to electro-static discharges and associated transients. The improved ESD tolerance is at least $\pm 15\text{kV}$ without damage nor latch-up.

There are different methods of ESD testing applied:

- a. MIL-STD-883, Method 3015.7
- b. IEC61000-4-2 Air-Discharge
- c. IEC61000-4-2 Direct Contact

The Human Body Model has been the generally accepted ESD testing method for semiconductors. This method is also specified in MIL-STD-883, Method 3015.7 for ESD testing. The premise of this ESD test is to simulate the human body's potential to store electro-static energy and discharge it to an integrated circuit. The simulation is performed by using a test model as shown in [Figure 18](#). This method will test the IC's capability to withstand an ESD transient during normal handling such as in manufacturing areas where the IC's tend to be handled frequently.

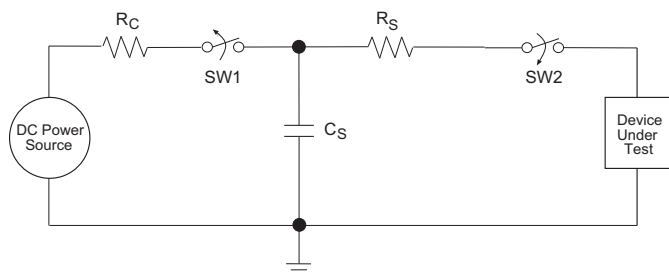

Figure 18: ESD Test Circuit for Human Body Model

The IEC61000-4-2, formerly IEC801-2, is generally used for testing ESD on equipment and systems. System manufacturers must guarantee a certain amount of ESD protection since the system itself is exposed to the outside environment and human presence. The premise with IEC61000-4-2 is that the system is required to withstand an amount of static electricity when ESD is applied to points and surfaces of the equipment that are accessible to personnel during normal usage. The transceiver IC receives most of the ESD current when the ESD source is applied to the connector pins. The test circuit for IEC61000-4-2 is shown on [Figure 19](#). There are two methods within IEC61000-4-2, the Air Discharge method and the Contact Discharge method.

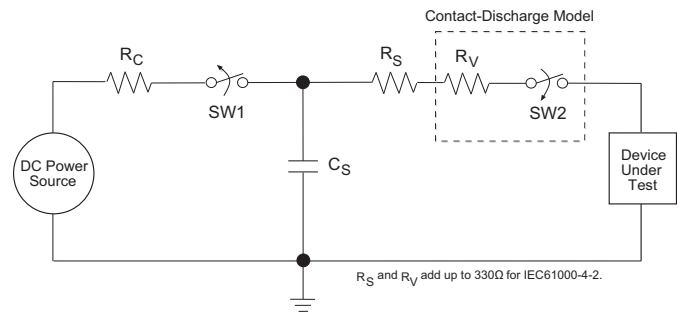

Figure 19: ESD Test Circuit for IEC61000-4-2

With the Air Discharge Method, an ESD voltage is applied to the equipment under test (EUT) through air. This simulates an electrically charged person ready to connect a cable onto the rear of the system only to find an unpleasant zap just before the person touches the back panel. The high energy potential on the person discharges through an arcing path to the rear panel of the system before he or she even touches the system. This energy, whether discharged directly or through air, is predominantly a function of the discharge current rather than the discharge voltage. Variables with an air discharge such as approach speed of the object carrying the ESD potential to the system and humidity will tend to change the discharge current. For example, the rise time of the discharge current varies with the approach speed.

The Contact Discharge Method applies the ESD current directly to the EUT. This method was devised to reduce the unpredictability of the ESD arc. The discharge current rise time is constant since the energy is directly transferred without the air-gap arc. In situations such as hand held systems, the ESD charge can be directly discharged to the equipment from a person already holding the equipment. The current is transferred on to the keypad or the serial port of the equipment directly and then travels through the PCB and finally to the IC.

The circuit model in [Figure 18](#) and [Figure 19](#) represent the typical ESD testing circuit used for all three methods. The C_S is initially charged with the DC power supply when the first switch (SW1) is on. Now that the capacitor is charged, the second switch (SW2) is on while SW1 switches off. The voltage stored in the capacitor is then applied through R_S , the current limiting resistor, onto the device under test (DUT). In ESD tests, the SW2 switch is pulsed so that the device under test receives a duration of voltage.

For the Human Body Model, the current limiting resistor (R_S) and the source capacitor (C_S) are $1.5k\Omega$ and $100pF$, respectively. For IEC-61000-4-2, the current limiting resistor (R_S) and the source capacitor (C_S) are 330Ω and $150pF$, respectively.

The higher C_S value and lower R_S value in the IEC61000-4-2 model are more stringent than the Human Body Model. The larger storage capacitor injects a higher voltage to the test point when SW2 is switched on. The lower current limiting resistor increases the current charge onto the test point.

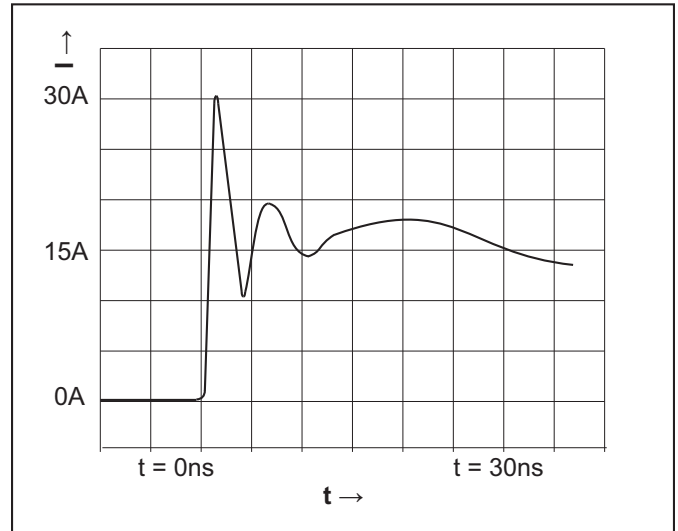
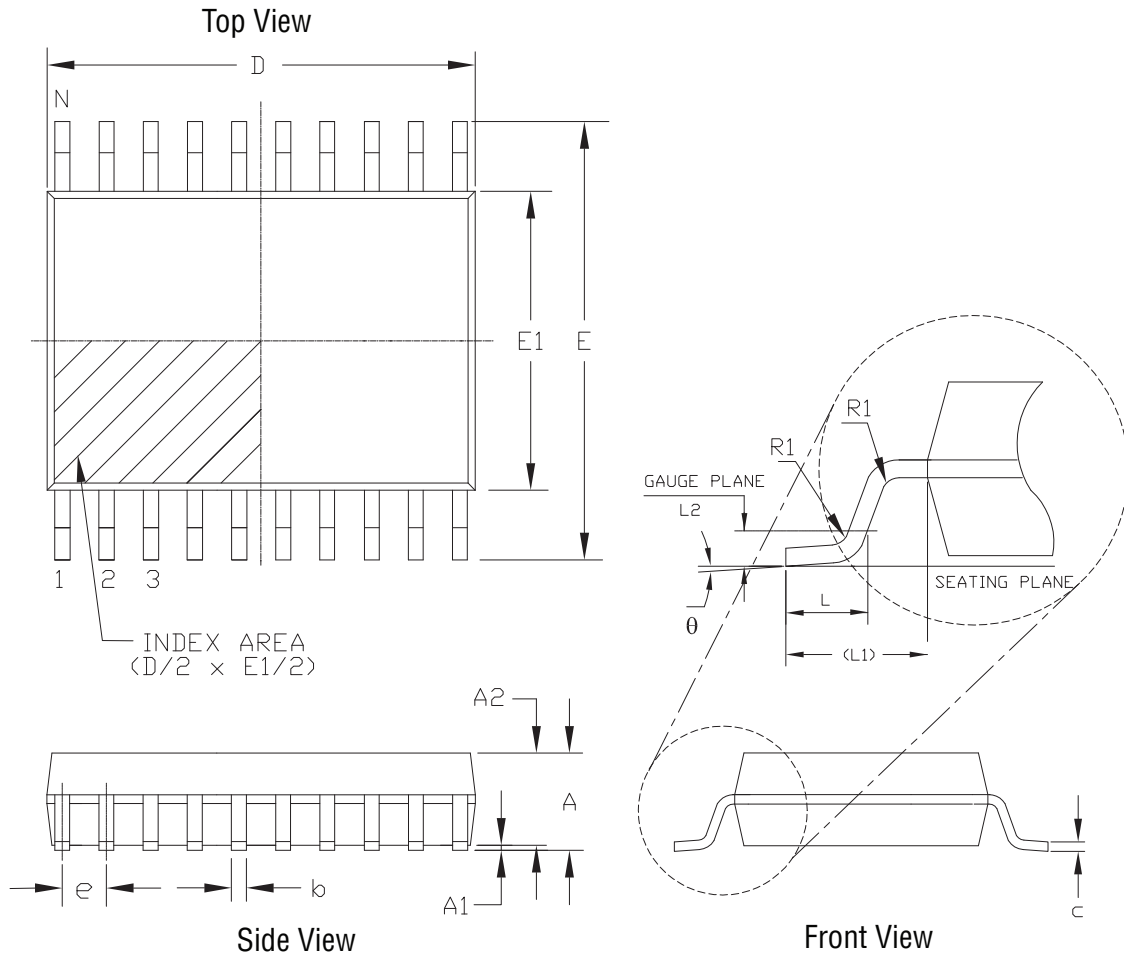

Figure 20: ESD Test Waveform for IEC61000-4-2

Mechanical Dimensions

SSOP20



PACKAGE OUTLINE SSOP 5.3mm BODY JEDEC MO-150 VARIATION A E						
SYMBOLS	COMMON DIMENSIONS IN MM (Control Unit)			COMMON DIMENSIONS IN INCH (Reference Unit)		
	MIN	NOM	MAX	MIN	NOM	MAX
A	—	—	2.00	—	—	0.079
A1	0.05	—	—	0.002	—	—
A2	1.65	1.75	1.85	0.065	0.069	0.073
b	0.22	—	0.38	0.009	—	0.015
c	0.09	—	0.25	0.004	—	0.010
E	7.40	7.80	8.20	0.291	0.307	0.323
E1	5.00	5.30	5.60	0.197	0.209	0.220
e	0.65 BSC			0.026 BSC		
L	0.55	0.75	0.95	0.022	0.030	0.037
L1	1.25 REF			0.049 REF		
L2	0.25 BSC			0.010 BSC		
R1	0.09	—	—	0.004	—	—
θ	0°	4°	8°	0°	4°	8°
D	6.90	7.20	7.50	.272	0.283	0.295
N	20					

Drawing No: POD-00000119

Revision: A

Figure 21: Mechanical Dimensions, SSOP20

SSOP16

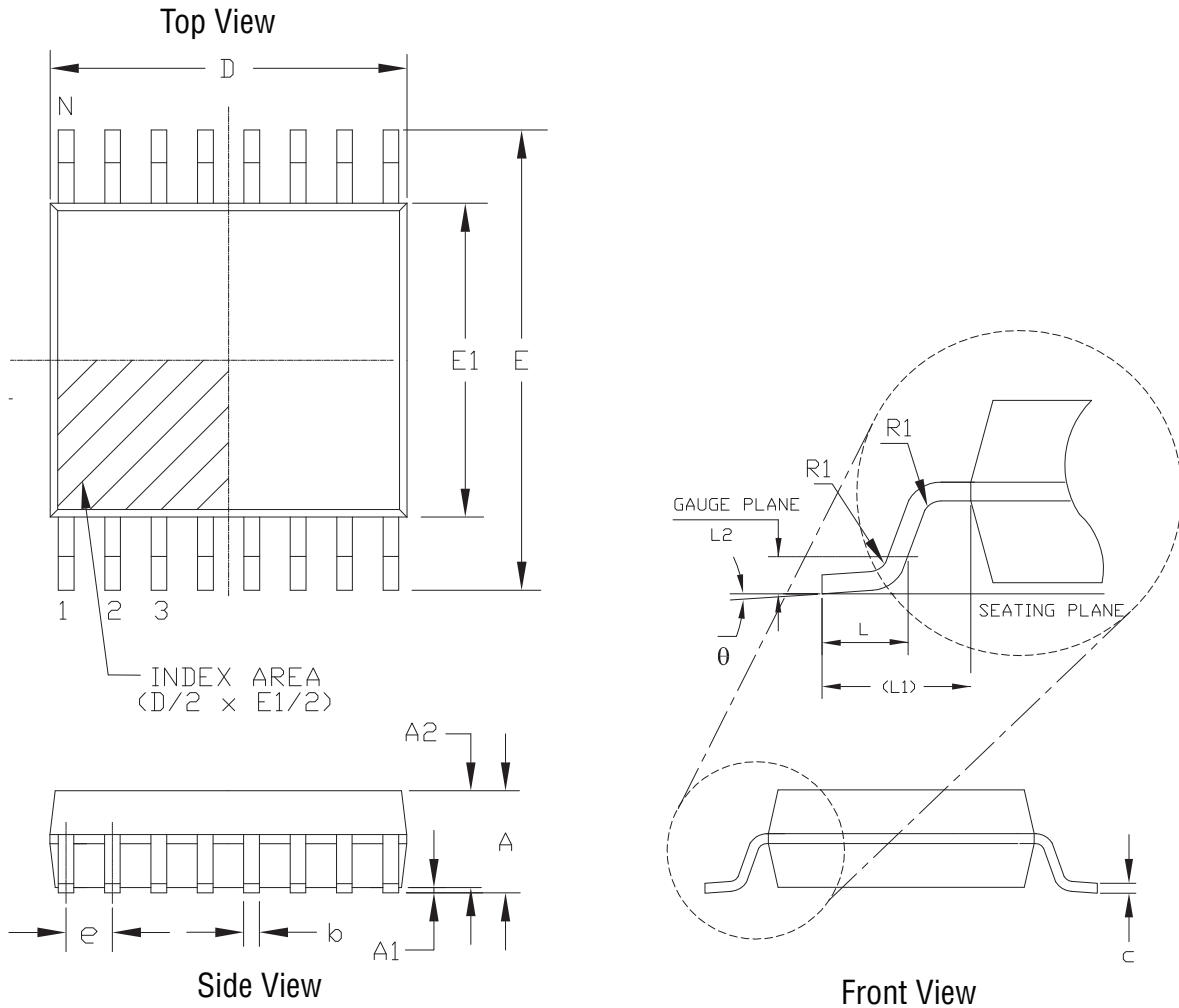

PACKAGE OUTLINE SSOP 5.3mm BODY JEDEC MO-150 VARIATION AC						
SYMBOLS	COMMON DIMENSIONS IN MM (Control Unit)			COMMON DIMENSIONS IN INCH (Reference Unit)		
	MIN	NOM	MAX	MIN	NOM	MAX
A	—	—	2.00	—	—	0.079
A1	0.05	—	—	0.002	—	—
A2	1.65	1.75	1.85	0.065	0.069	0.073
b	0.22	—	0.38	0.009	—	0.015
c	0.09	—	0.25	0.004	—	0.010
E	7.40	7.80	8.20	0.291	0.307	0.323
E1	5.00	5.30	5.60	0.197	0.209	0.220
e	0.65 BSC			0.026 BSC		
L	0.55	0.75	0.95	0.022	0.030	0.037
L1	1.25 REF			0.049 REF		
L2	0.25 BSC			0.010 BSC		
R1	0.09	—	—	0.004	—	—
θ	0°	4°	8°	0°	4°	8°
D	5.90	6.20	6.50	0.232	0.244	0.256
N	16					

Drawing No: POD-00000116
Revision: A

Figure 22: Mechanical Dimensions, SSOP16

NSOIC16

Top View

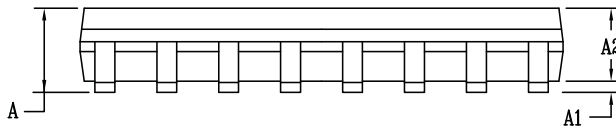
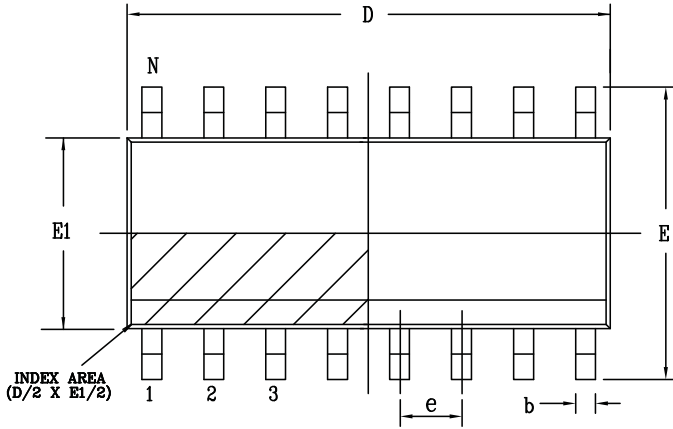

Side View

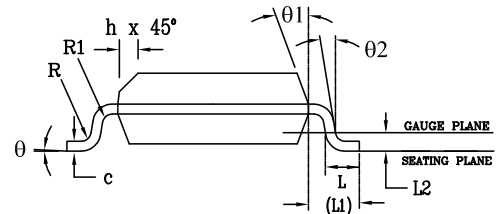

Front View

PACKAGE OUTLINE NSOIC .150" BODY JEDEC MS-012 VARIATION A C						
SYMBOLS	COMMON DIMENSIONS IN MM (Control Unit)			COMMON DIMENSIONS IN INCH (Reference Unit)		
	MIN	NOM	MAX	MIN	NOM	MAX
A	1.35	—	1.75	0.053	—	0.069
A1	0.10	—	0.25	0.004	—	0.010
A2	1.25	—	1.65	0.049	—	0.065
b	0.31	—	0.51	0.012	—	0.020
c	0.17	—	0.25	0.007	—	0.010
E	6.00 BSC			0.236 BSC		
E1	3.90 BSC			0.154 BSC		
e	1.27 BSC			0.050 BSC		
h	0.25	—	0.50	0.010	—	0.020
L	0.40	—	1.27	0.016	—	0.050
L1	1.04 REF			0.041 REF		
L2	0.25 BSC			0.010 BSC		
R	0.07	—	—	0.003	—	—
R1	0.07	—	—	0.003	—	—
q	0°	—	8°	0°	—	8°
q1	5°	—	15°	5°	—	15°
q2	0°	—	—	0°	—	—
D	9.90 BSC			0.390 BSC		
N	16					

Drawing No: POD-00000114

Revision: A

Figure 23: Mechanical Dimensions, NSOIC16

TSSOP16

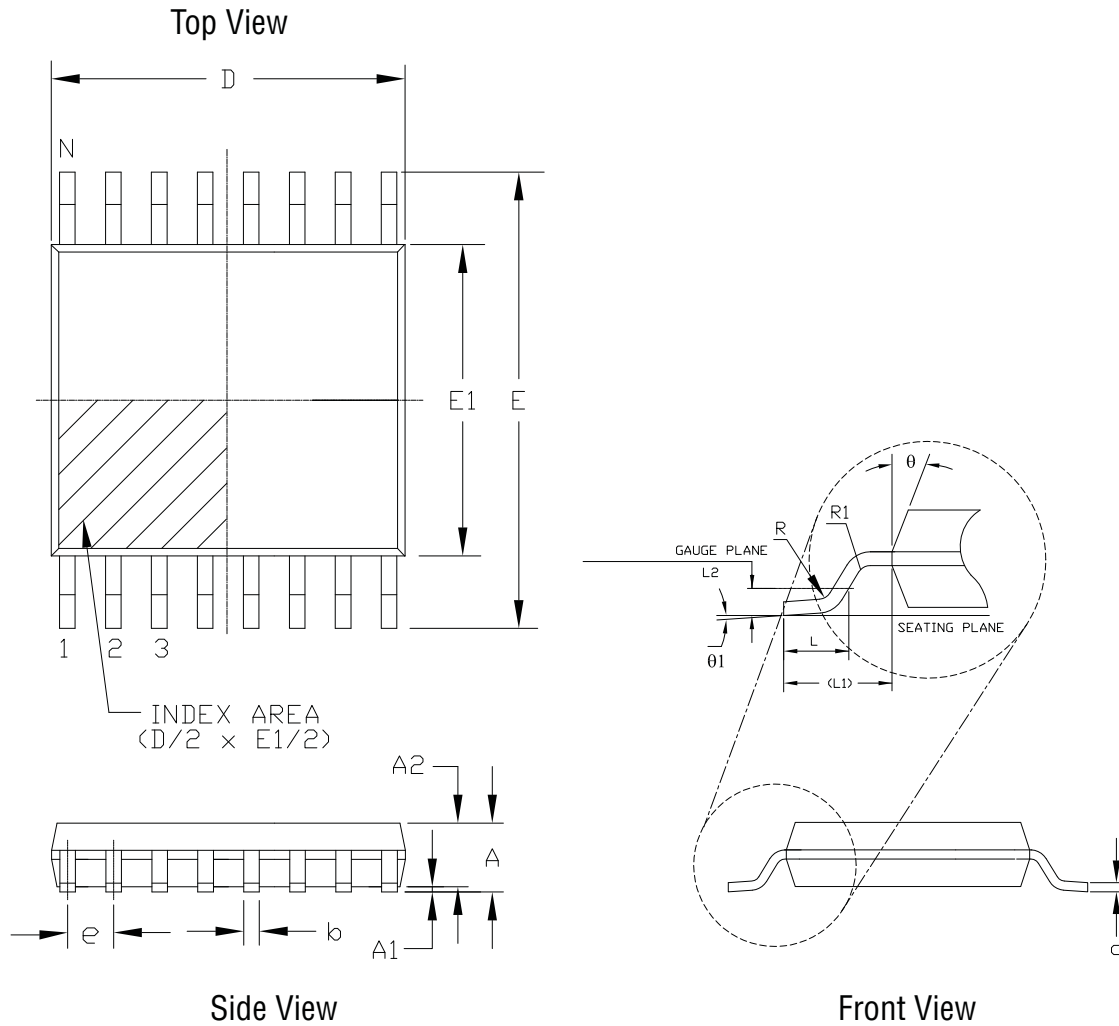

16 Pin TSSOP JEDEC MO-153 Variation AB						
SYMBOLS	DIMENSIONS IN MM (Control Unit)			DIMENSIONS IN INCH (Reference Unit)		
	MIN	NOM	MAX	MIN	NOM	MAX
A	—	—	1.20	—	—	0.047
A1	0.05	—	0.15	0.002	—	0.006
A2	0.80	1.00	1.05	0.031	0.039	0.041
b	0.19	—	0.30	0.007	—	0.012
c	0.09	—	0.20	0.004	—	0.008
E	6.40 BSC			0.252 BSC		
E1	4.30	4.40	4.50	0.169	0.173	0.177
e	0.65 BSC			0.026 BSC		
L	0.45	0.60	0.75	0.018	0.024	0.030
L1	1.00 REF			0.039 REF		
L2	0.25 BSC			0.010 BSC		
R	0.09	—	—	0.035	—	—
R1	0.09	—	—	0.035	—	—
θ	12° REF			12° REF		
θ1	0°	—	8°	0°	—	8°
D	4.90	5.00	5.10	0.193	0.197	0.200
N	16			16		

Drawing No: POD-0000117
Revision: A

Figure 24: Mechanical Dimensions, TSSOP16

TSSOP20

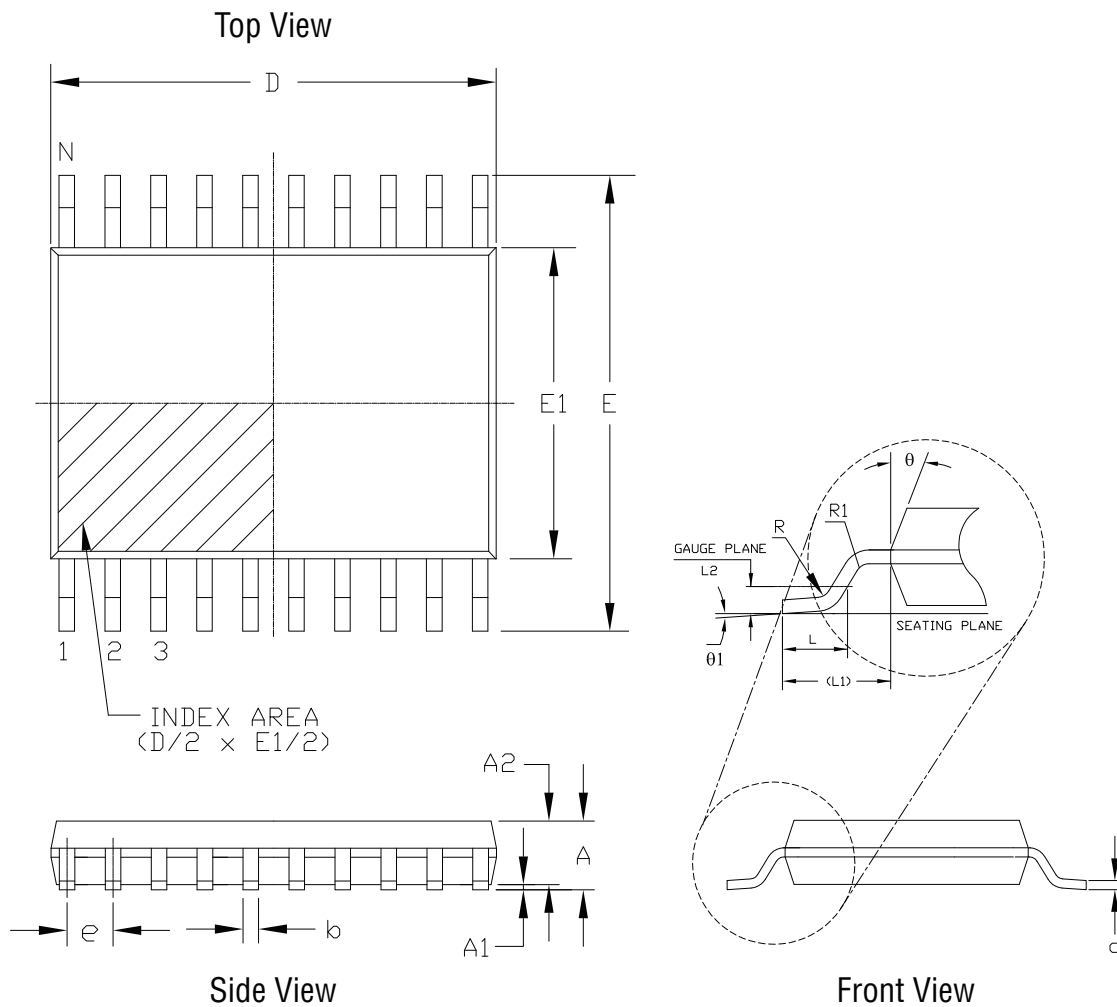

20 Pin TSSOP JEDEC MO-153 Variation AC						
SYMBOLS	DIMENSIONS IN MM (Control Unit)			DIMENSIONS IN INCH (Reference Unit)		
	MIN	NOM	MAX	MIN	NOM	MAX
A	—	—	1.20	—	—	0.047
A1	0.05	—	0.15	0.002	—	0.006
A2	0.80	1.00	1.05	0.031	0.039	0.041
b	0.19	—	0.30	0.007	—	0.012
c	0.09	—	0.20	0.004	—	0.008
E	6.40 BSC			0.252 BSC		
E1	4.30	4.40	4.50	0.169	0.173	0.177
e	0.65 BSC			0.026 BSC		
L	0.45	0.60	0.75	0.018	0.024	0.030
L1	1.00 REF			0.039 REF		
L2	0.25 BSC			0.010 BSC		
R	0.09	—	—	0.035	—	—
R1	0.09	—	—	0.035	—	—
θ	12° REF			12° REF		
$\theta1$	0°	—	8°	0°	—	8°
D	6.40	6.50	6.60	0.252	0.256	0.260
N	20			20		

Drawing No: POD-00000120

Revision: A

Figure 25: Mechanical Dimensions, TSSOP20

QFN16 5x5

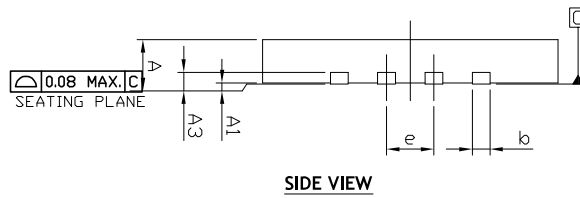
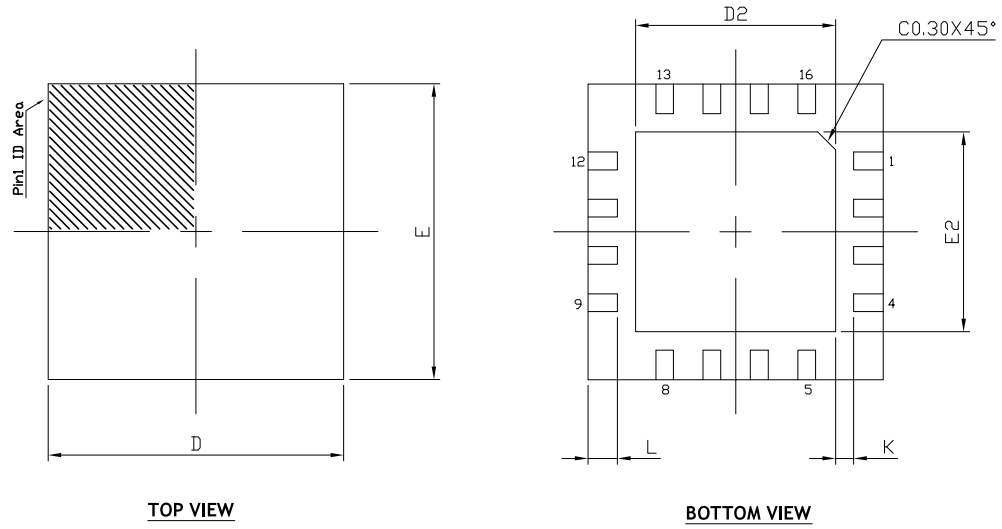

DIMENSION TABLE				
SYMBOL	MIN	NOM	MAX	NOTE
A	0.80	0.85	0.90	
A1	0.00	0.02	0.05	
A3	0.203 Ref			
b	0.25	0.30	0.35	
D	4.95	5.00	5.05	
E	4.95	5.00	5.05	
e	0.80 BSC			
D2	3.28	3.38	3.43	
E2	3.28	3.38	3.43	
L	0.45	0.50	0.55	
K	0.20	-	-	

TERMINAL DETAILS

- ALL DIMENSIONS ARE IN MILLIMETERS.
- DIMENSIONS AND TOLERANCE PER JEDEC MO-220.

Drawing No.: POD-00000160

Revision: A

Figure 26: Mechanical Dimensions, QFN16 5x5

Ordering Information

Table 7: Ordering Information⁽¹⁾

Ordering Part Number	Operating Temperature Range	Package	Packaging Method	Lead-Free ⁽²⁾
SP3222EB				
SP3222EBEA-L/TR	−40°C to 85°C	20 Pin SSOP	Reel	Yes
SP3222EBEY-L/TR	−40°C to 85°C	20 Pin TSSOP	Reel	Yes
SP3232EB				
SP3232EBCA-L/TR	0°C to 70°C	16 Pin SSOP	Reel	Yes
SP3232EBCN-L	0°C to 70°C	16-pin NSOIC	Tube	Yes
SP3232EBCN-L/TR	0°C to 70°C	16-pin NSOIC	Reel	Yes
SP3232EBCY-L/TR	0°C to 70°C	16 Pin TSSOP	Reel	Yes
SP3232EBEA-L/TR	−40°C to 85°C	16 Pin SSOP	Reel	Yes
SP3232EBEN-L/TR	−40°C to 85°C	16-pin NSOIC	Reel	Yes
SP3232EBEY-L/TR	−40°C to 85°C	16 Pin TSSOP	Reel	Yes
SP3232EBER-L/TR	−40°C to 85°C	16 Pin QFN	Reel	Yes

1. Refer to www.maxlinear.com/SP3222EB and www.maxlinear.com/SP3232EB for most up-to-date Ordering Information.
2. Visit www.maxlinear.com for additional information on Environmental Rating.



MaxLinear, Inc.
5966 La Place Court, Suite 100
Carlsbad, CA 92008
760.692.0711 p.
760.444.8598 f.
www.maxlinear.com

The content of this document is furnished for informational use only, is subject to change without notice, and should not be construed as a commitment by MaxLinear, Inc. MaxLinear, Inc. assumes no responsibility or liability for any errors or inaccuracies that may appear in the informational content contained in this guide. Complying with all applicable copyright laws is the responsibility of the user. Without limiting the rights under copyright, no part of this document may be reproduced into, stored in, or introduced into a retrieval system, or transmitted in any form or by any means (electronic, mechanical, photocopying, recording, or otherwise), or for any purpose, without the express written permission of MaxLinear, Inc.

MaxLinear, Inc. does not recommend the use of any of its products in life support applications where the failure or malfunction of the product can reasonably be expected to cause failure of the life support system or to significantly affect its safety or effectiveness. Products are not authorized for use in such applications unless MaxLinear, Inc. receives, in writing, assurances to its satisfaction that: (a) the risk of injury or damage has been minimized; (b) the user assumes all such risks; (c) potential liability of MaxLinear, Inc. is adequately protected under the circumstances.

MaxLinear, Inc. may have patents, patent applications, trademarks, copyrights, or other intellectual property rights covering subject matter in this document. Except as expressly provided in any written license agreement from MaxLinear, Inc., the furnishing of this document does not give you any license to these patents, trademarks, copyrights, or other intellectual property.

MaxLinear, the MaxLinear logo, and any MaxLinear trademarks, MxL, Full-Spectrum Capture, FSC, G.now, AirPHY and the MaxLinear logo are all on the products sold, are all trademarks of MaxLinear, Inc. or one of MaxLinear's subsidiaries in the U.S.A. and other countries. All rights reserved. Other company trademarks and product names appearing herein are the property of their respective owners.

X-ON Electronics

Largest Supplier of Electrical and Electronic Components

Click to view similar products for [RS-232 Interface IC category](#):

Click to view products by [MaxLinear manufacturer](#):

Other Similar products are found below :

[062191EB](#) [CH438L](#) [LT1039CN](#) [MAX3386ECPWR](#) [TRS222IDWR](#) [MAX232INE4](#) [MAX3232CPW](#) [MAX204CWE+](#) [TRS3243EIDWR](#)
[TRS3232EIDWR](#) [SN65C3232EDWR](#) [ADM208ARZ-REEL](#) [LT1780CSW#PBF](#) [LT1237CSW#PBF](#) [LT1281AISW#PBF](#) [LTC1337CSW#PBF](#)
[LT1180ACN#PBF](#) [LTC1343CGW#PBF](#) [LT1237CNW#PBF](#) [LT1039CN#PBF](#) [LT1032CSW#PBF](#) [LT1130ACSW#PBF](#) [LTC1349ISW#PBF](#)
[LT1032ISW#PBF](#) [LTM2882IY-3#PBF](#) [LT1140ACN#PBF](#) [LTC1384IG#PBF](#) [LTC1383CS#PBF](#) [LT1280AIN#PBF](#) [LT1080ISW#PBF](#)
[LTC2845IG#PBF](#) [LTC1383CN#PBF](#) [LTC2845CG#PBF](#) [LTC2846CG#PBF](#) [LTC1385IG#PBF](#) [LTC1384CG#PBF](#) [LT1781IS#PBF](#)
[LT1081IN#PBF](#) [SN75188DE4](#) [LTC1350CNW](#) [MAX3209EEUU+T](#) [AD7306AR](#) [AD7306ARZ](#) [AD7306JNZ](#) [AD7306JRZ](#)
[ADM3311EARSZ-REEL](#) [ADM3310EACPZ-REEL7](#) [ADM3202ARUZ-REEL7](#) [ADM101EARMZ-REEL7](#) [ADM1181AAN](#)