

1、订货代码 HOW TO ORDER

举例 For example

XR	0307	—	220	K	P	52	E
↓	↓		↓	↓	↓	↓	↓
A	B		C	D	E	F	G

产品类别 Product type	
XR	轴向色码电感器 Axial color code inductor

C:

标称电感量 Nominal inductance (μH)	
前两位数字为有效数字，后一位数字表示零的个数。	

The first two digits are significant, and the third digit is number of zero.

* 例如 For example : 101=100μH ;
5R6=5.6μH R22=0.22μ H

E:

包装方式 Packaging style		
编带 Tape & reel	P	盒带包装 Ammo
	T	卷带包装 Reel
散包装 Bulk	F	直脚轴向 Axial
	L	直脚成型 Straight lead formed
	V	弯脚成型 Bent lead formed
	VK	弯脚 K 型 Bent lead K formed

G:

备注 Remark	
E	无铅 Lead Free
空格 Blank	含铅 Lead Contained



B:

尺寸 Dimensions (mm)		
类型 Type	外径 D _{max}	体长 L _{max}
0204	2.3	4.2
0307	2.8	7.0
0410	4.0	10.5
0510	5.0	10.5

D:

感量偏差 Tolerance	
J	±5.0%
K	±10%
M	±20%

F:

引脚形式 Lead configuration		
编带 Tape & reel	26	编带内距 : 26mm Tape width:
	52	编带内距 : 52mm Tape width:
引脚成型 Formed lead	05	引脚脚距 : 5.08mm Formed lead pitch:
	07	引脚脚距 : 7.5mm Formed lead pitch:
	10	引脚脚距 : 10.0mm Formed lead pitch:
	12	引脚脚距 : 12.5mm Formed lead pitch:
	15	引脚脚距 : 15.0mm Formed lead pitch:
	17	引脚脚距 : 17.5mm Formed lead pitch:
	20	引脚脚距 : 20.0mm Formed lead pitch:

2、外形尺寸 EXTERNAL DIMENSIONS

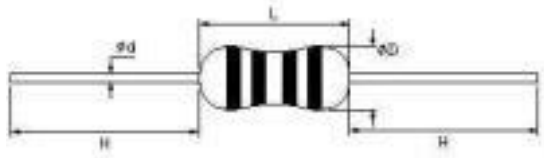
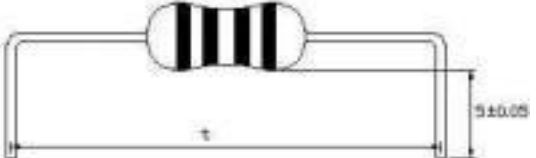
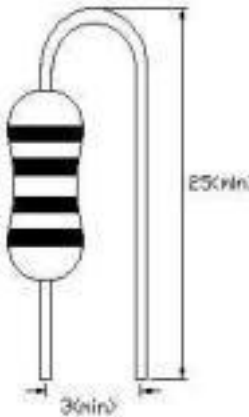
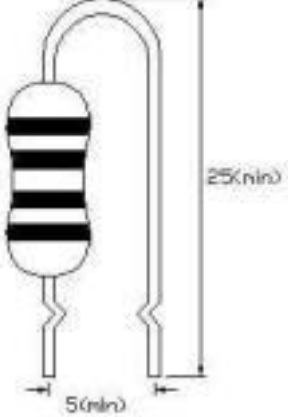
类型 Type	尺寸 Body size (mm)					 轴向 (Axial)
	$\phi D \leq$	$L \leq$	t	Φd	$H \geq$	
XR0204	2.3	4.2	t = 5.08±0.6 t = 7.50±0.6	0.50 ±0.05	20	 直脚成型 (L type)
XR0307	2.8	7.0	t = 10.0±0.6 t = 12.5±0.6	0.50 ±0.05		 弯脚成型 (V type)
XR0410	4.0	10.5	t = 12.5±0.6 t = 15.0±0.6 t = 17.5±0.6 t = 20.0±0.6	0.60 ±0.05		 弯脚 K 型 (VK type)
XR0510	5.0	10.5	t = 15.0±0.6 t = 17.5±0.6 t = 20.0±0.6	0.65 ±0.05		

3、产品结构 STRUCTURE

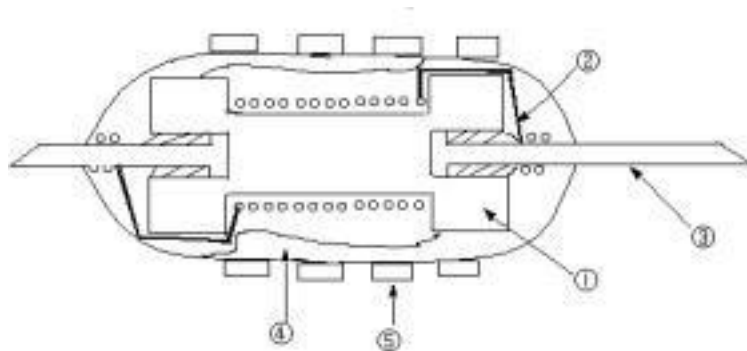

序号 NO.	① 磁芯 Core	② 漆包线 Wire	③ 引脚 Lead	④ 涂覆层 Coating	⑤ 色码 Color code
材料名称 Material name	铁氧体 Ferrite	漆包铜线 Enamelled wire	镀锡铜线 Tinned copper wire	环氧树脂 Epoxy resin	环氧色漆 Epoxy paint for Color coding

4、色码标记代号 MARKING

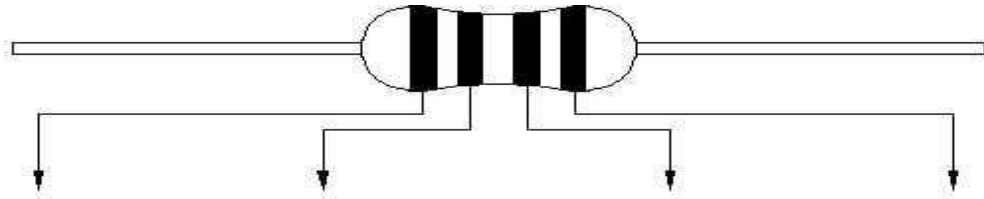

	标称电感量 Nominal inductance (μH)			感量偏差 Tolerance
	第一色环 1 st color zone	第二色环 2 nd color zone	第三色环 3 rd color zone	第四色环 4 th color zone
	第一数字 1 st digit	第二数字 2 nd digit	第三数字 3 rd digit	
黑 Black	0	0	$\times 10^0 (1)$	M : $\pm 20\%$
棕 Brown	1	1	$\times 10^1 (10)$	
红 Red	2	2	$\times 10^2 (100)$	
橙 Orange	3	3	$\times 10^3 (1000)$	
黄 Yellow	4	4	$\times 10^4 (10000)$	
绿 Green	5	5	$\times 10^5 (100000)$	
蓝 Blue	6	6		
紫 Purple	7	7		
灰 Gray	8	8		
白 White	9	9		
金 Gold	/	/	$\times 10^{-1} (0.1)$	J : $\pm 5\%$
银 Silver	/	/	$\times 10^{-2} (0.01)$	K : $\pm 10\%$

*例如 e.g. :

标称电感量及偏差为 22 μH , $\pm 5\%$ 的电感器其色码为：红+红+黑+金；

If nominal inductance & tolerance is 22 μH , $\pm 5\%$, respectively red+red+black+gold should be marked;

标称电感量及偏差为 1.0 μH , $\pm 10\%$ 的电感器其色码为：棕+黑+金+银；

If nominal inductance & tolerance is 1.0 μH , $\pm 10\%$, respectively brown+black+gold+silver should be marked;

标称电感量及偏差为 0.22 μH , $\pm 20\%$ 的电感器其色码为：红+红+银+黑。

If nominal inductance & tolerance is 0.22 μH , $\pm 20\%$, respectively red+red+silver+black should be marked.

备注：XR0204 由于体长较小，只标注前三条代表标称电感量的色码。

NOTE: Only the first three color zones are marked on the body of XR0204, due to the small body size.

5、电性能参数及测试条件

ELECTRICAL CHARACTERISTICS & TEST CONDITIONS

XR0204 型电感器电性能参数及测试条件

XR0204 TYPE INDUCTORS ELECTRICAL CHARACTERISTICS & TEST CONDITIONS

XR0204 类型 Type	电感量 Inductance (μH)	误差 Tolerance	Q (min)	直流电阻 RDC (Ω) max	测试频率 Test frequency (MHz)	自谐频率 SRF (MHz) min	额定电流 Rated current I_{dc} (mA) max
XR0204-R22	0.22	M : $\pm 20\%$	35	0.40	25.2	150	400
XR0204-R27	0.27			380			
XR0204-R33	0.33			370			
XR0204-R39	0.39			350			
XR0204-R47	0.47			330			
XR0204-R56	0.56			320			
XR0204-R68	0.68			310			
XR0204-R82	0.82			290			
XR0204-1R0	1.0			270			
XR0204-1R2	1.2			K : $\pm 10\%$			40
XR0204-1R5	1.5	80	250				
XR0204-1R8	1.8	60	240				
XR0204-2R2	2.2	45	230				
XR0204-2R7	2.7	40	220				
XR0204-3R3	3.3	38	210				
XR0204-3R9	3.9	35	200				
XR0204-4R7	4.7	32	190				
XR0204-5R6	5.6	30	180				
XR0204-6R8	6.8	28	175				
XR0204-8R2	8.2	26	165				
XR0204-100	10	24	160				
XR0204-120	12	22	150				
XR0204-150	15	20	145				
XR0204-180	18	18	140				
XR0204-220	22	17	130				
XR0204-270	27	16	80				
XR0204-330	33	14	76				
XR0204-390	39	13	73				
XR0204-470	47	12	70				
XR0204-560	56	11	68				
XR0204-680	68	10	64				
XR0204-820	82	9.5	46				
XR0204-101	100	9.0	44				
XR0204-121	120	13.0	42				
XR0204-151	150	16.0	39				
XR0204-181	180	18.0	37				
XR0204-221	220	20.0	35				
测试仪器 Test equipment	HP4285A (HP4286A , HP4287A)			HP4338B		HM9461	HP42841A
环境温度 Ambient temperature	18 ~ 25°C						
环境湿度 Ambient humidity	45%~75%						

特殊要求的产品可以根据客户要求生产

The products can be customized according to customer requirement.

XR0307 型电感器电性能参数及测试条件
 XR0307 TYPE INDUCTORS ELECTRICAL CHARACTERISTICS & TEST CONDITIONS

XR0307 类型 Type	电感量 Inductance (μH)	误差 Tolerance	Q (min)	直流电阻 RDC (Ω) max	测试频率 Test frequency (MHz)	自谐频率 SRF (MHz) min	额定电流 Rated current I_{DC} (mA) max			
XR0307-R22	0.22	M : $\pm 20\%$	35	0.40	25.2	150	400			
XR0307-R27	0.27			380						
XR0307-R33	0.33			370						
XR0307-R39	0.39			350						
XR0307-R47	0.47			330						
XR0307-R56	0.56			320						
XR0307-R68	0.68		310							
XR0307-R82	0.82		290							
XR0307-1R0	1.0		270							
XR0307-1R2	1.2		K : $\pm 10\%$	40			0.90	7.96	144	260
XR0307-1R5	1.5						1.0		131	250
XR0307-1R8	1.8						1.1		121	240
XR0307-2R2	2.2						1.2		110	230
XR0307-2R7	2.7						1.3		100	220
XR0307-3R3	3.3						1.4		94	210
XR0307-3R9	3.9			1.6			65		200	
XR0307-4R7	4.7			1.7			56		190	
XR0307-5R6	5.6			1.9			48		180	
XR0307-6R8	6.8	2.0		37	175					
XR0307-8R2	8.2	2.2		25	165					
XR0307-100	10	2.5		21	160					
XR0307-120	12	2.5		19	150					
XR0307-150	15	2.8		17	145					
XR0307-180	18	3.1		13	140					
XR0307-220	22	3.4		9.6	130					
XR0307-270	27	3.8		7.2	125					
XR0307-330	33	J : $\pm 5\%$		50	4.1	2.52	6.3		120	
XR0307-390	39		4.5		6.3		115			
XR0307-470	47		4.9		6.3		110			
XR0307-560	56		5.3		6.2		105			
XR0307-680	68		5.8		5.7		100			
XR0307-820	82		6.3		5.3		95			
XR0307-101	100		7.0		4.8		90			
XR0307-121	120		13.0		3.8		90			
XR0307-151	150		15.0		3.5		85			
XR0307-181	180		16.0		3.3		80			
XR0307-221	220		17.0		3.0		75			
XR0307-271	270		19.0		2.8		65			
XR0307-331	330		20.0		2.6		60			
XR0307-391	390		22.0		2.4		55			
XR0307-471	470		24.0		2.25		55			
XR0307-561	560		26.0		2.10		50			
XR0307-681	680		28.0		1.95		45			
XR0307-821	820		30.0		1.85		40			
XR0307-102	1000	33.0	1.40	40						
测试仪器 Test equipment	HP4285A (HP4286A , HP4287A)			HP4338B		HM9461	HP42841A			
环境温度 Ambient temperature	18 ~ 25°C									
环境湿度 Ambient humidity	45%~75%									

特殊要求的产品可以根据客户要求生产
 The products can be customized according to customer requirement.

XR0410 型电感器电性能参数及测试条件

XR0410 TYPE INDUCTORS ELECTRICAL CHARACTERISTICS & TEST CONDITIONS

XR0410 类型 Type	电感量 Inductance (μH)	误差 Tolerance	Q (min)	直流电阻 RDC (Ω) max	测试频率 Test frequency (MHz)	自谐频率 SRF (MHz) min	额定电流 Rated current I_{DC} (mA) max
XR0410-R22	0.22	M : $\pm 20\%$	45	0.10	25.2	300	1400
XR0410-R27	0.27		45	0.11		270	1320
XR0410-R33	0.33		45	0.12		250	1280
XR0410-R39	0.39		45	0.13		230	1200
XR0410-R47	0.47		45	0.14		220	1150
XR0410-R56	0.56		45	0.15		200	1122
XR0410-R68	0.68		45	0.16		190	1030
XR0410-R82	0.82		45	0.17		172	980
XR0410-1R0	1.0		45	0.19		157	920
XR0410-1R2	1.2		50	0.21		144	880
XR0410-1R5	1.5		50	0.23	131	830	
XR0410-1R8	1.8		55	0.25	121	790	
XR0410-2R2	2.2		55	0.28	110	750	
XR0410-2R7	2.7		60	0.30	100	720	
XR0410-3R3	3.3		65	0.34	94	670	
XR0410-3R9	3.9		65	0.37	65	640	
XR0410-4R7	4.7		70	0.39	56	620	
XR0410-5R6	5.6		70	0.43	48	590	
XR0410-6R8	6.8		75	0.48	37	550	
XR0410-8R2	8.2		80	0.52	25	530	
XR0410-100	10	65	0.58	21	500		
XR0410-120	12	50	0.63	19	480		
XR0410-150	15	50	0.72	17	460		
XR0410-180	18	50	0.77	13	430		
XR0410-220	22	50	0.84	9.6	410		
XR0410-270	27	55	0.94	7.2	390		
XR0410-330	33	55	1.03	6.3	370		
XR0410-390	39	50	1.12	6.3	350		
XR0410-470	47	45	1.22	6.3	340		
XR0410-560	56	40	1.34	6.2	320		
XR0410-680	68	40	1.47	5.7	305		
XR0410-820	82	35	1.62	5.3	290		
XR0410-101	100	30	1.80	4.8	275		
XR0410-121	120	55	3.70	3.8	185		
XR0410-151	150	45	4.20	3.5	175		
XR0410-181	180	50	4.60	3.3	165		
XR0410-221	220	55	5.10	3.0	155		
XR0410-271	270	65	5.80	2.8	145		
XR0410-331	330	65	6.40	2.6	137		
XR0410-391	390	65	7.00	2.4	133		
XR0410-471	470	60	7.70	2.25	126		
XR0410-561	560	60	8.50	2.10	120		
XR0410-681	680	55	9.40	1.95	113		
XR0410-821	820	55	10.50	1.85	105		
XR0410-102	1000	50	14.00	1.40	100		
XR0410-152	1500	30	25.00	0.252	1.10	85	
XR0410-222	2200	30	35.00	0.252	0.80	75	
测试仪器 Test equipment	HP4285A (HP4286A ,HP4287A)			HP4338B		HM9461	HP42841A
环境温度 Ambient temperature	18 ~ 25°C						
环境湿度 Ambient humidity	45%~75%						

特殊要求的产品可以根据客户要求生产

The products can be customized according to customer requiremen

XR0510 型电感器电性能参数及测试条件
 XR0510 TYPE INDUCTORS ELECTRICAL CHARACTERISTICS & TEST CONDITIONS

XR0510 类型 Type	电感量 Inductance (μH)	误差 Tolerance	Q (min)	直流电阻 RDC (Ω) max	测试频率 Test frequency (MHz)	自谐频率 SRF (MHz) min	额定电流 Rated current I_{DC} (mA) max	
XR0510-2R2	2.2	M: $\pm 20\%$	10	0.26	7.96	50	2100	
XR0510-3R3	3.3		10	0.3		50	1800	
XR0510-3R9	3.9		10	0.35		50	1500	
XR0510-4R7	4.7		20	0.43		50	900	
XR0510-6R8	6.8		15	0.45		45	850	
XR0510-100	10		15	0.45		30	750	
XR0510-120	12		30	0.6		30	700	
XR0510-150	15		30	0.65		30	650	
XR0510-180	18		30	0.65		30	600	
XR0510-220	22		K: $\pm 10\%$	30	0.65	2.52	8	550
XR0510-270	27			30	0.65		7	500
XR0510-330	33			30	0.65		6	470
XR0510-390	39			30	0.65		6	460
XR0510-470	47			30	0.8		5	430
XR0510-560	56			30	0.8		5	430
XR0510-680	68			30	0.8		4.5	430
XR0510-820	82			30	0.82		3.8	430
XR0510-101	100			30	0.9		3.5	400
XR0510-121	120	30		0.92	3.3	390		
XR0510-151	150	30		0.92	3.2	390		
XR0510-181	180	30		0.94	2.8	390		
XR0510-221	220	30		0.94	2.6	380		
XR0510-271	270	30		1	2.4	380		
XR0510-331	330	30		1.11	2.2	380		
XR0510-391	390	30		1.12	2	350		
XR0510-471	470	J: $\pm 5\%$		45	1.22	0.796	1.9	340
XR0510-561	560			40	1.34		1.8	320
XR0510-681	680		40	1.47	1.5		305	
XR0510-821	820		35	1.62	1.3		290	
XR0510-102	1000		45	14	1		100	
XR0510-122	1200		40	16.9	0.95		95	
XR0510-152	1500		40	21.6	0.9		90	
XR0510-182	1800		40	24	0.85		85	
XR0510-222	2200		40	34.7	0.8		80	
XR0510-272	2700		40	40	0.75	75		
XR0510-332	3300		40	59.5	0.7	62		
XR0510-392	3900		40	66	0.65	59		
XR0510-472	4700		40	74	0.6	55		
XR0510-562	5600		30	80	0.5	40		
XR0510-682	6800		30	85	0.45	35		
XR0510-822	8200		30	95	0.4	30		
XR0510-103	10000		50	14	0.0796	1.4	100	
测试仪器 Test equipment	HP4285A (HP4286A ,HP4287A)			HP4338B		HM9461	HP42841A	
环境温度 Ambient temperature	18 ~ 25°C							
环境湿度 Ambient humidity	45%~75%							

特殊要求的产品可以根据客户要求生产

The products can be customized according to customer requirement.

6、包装方式 PACKAGING STYLE

- 编带尺寸 Taping dimensions

单位 Unit : mm

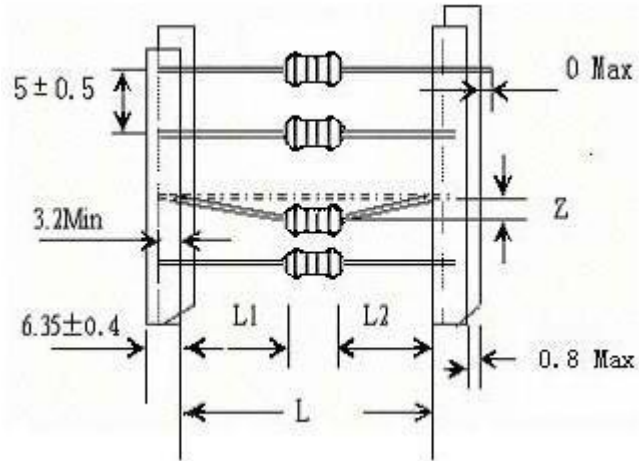

编带方式 Tape style	L	Z	L1-L2
编带内距:26 Tape width	26 ± 1.0	0.8 Max	1.0 Max
编带内距:52 Tape width	$52 \begin{smallmatrix} +2.0 \\ -1.0 \end{smallmatrix}$	1.2 Max	

- 卷带包装尺寸 Tape & reel packaging dimensions

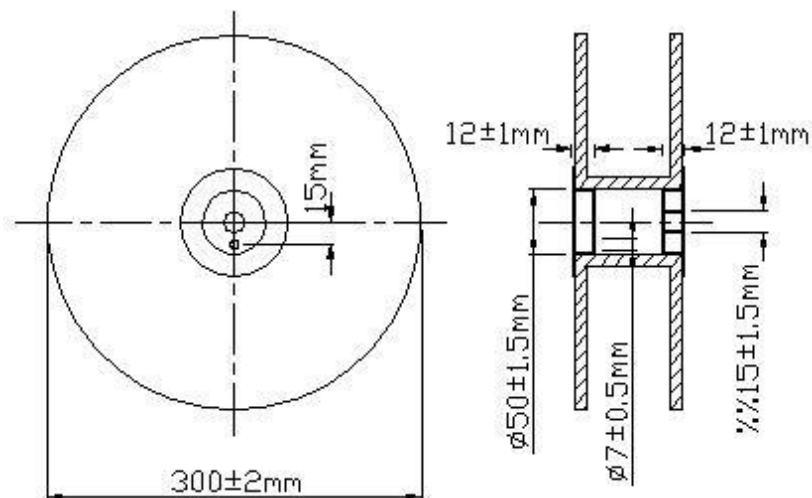

- 盒带包装尺寸 Ammo packaging dimensions

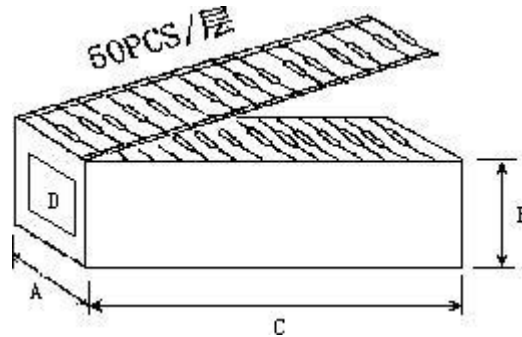

- 包装盒尺寸 Dimensions of box

单位 Unit : mm

编带类型 Tape type	尺寸 Dimensions (±5mm)		
	A	B	C
52	75	82	260
26	50	82	260

- 包装数量 Packaging quantity

包装方式 Packaging style	盒带包装 Ammo	卷带包装 Tape & reel	散包装 Bulk
包装数量 Quantity	2000	2000	1000

可根据用户需求包装

Packaging according to customer's requirement

X-ON Electronics

Largest Supplier of Electrical and Electronic Components

Click to view similar products for [Fixed Inductors](#) category:

Click to view products by [MaxLinear](#) manufacturer:

Other Similar products are found below :

[CR43NP-680KC](#) [CR54NP-470LC](#) [CR54NP-820KC](#) [CR54NP-8R5MC](#) [70F224AI](#) [MGDQ4-00004-P](#) [MHL1ECTTP18NJ](#) [MHQ1005P10NJ](#)
[MHQ1005P1N0S](#) [MHQ1005P2N4S](#) [MHQ1005P3N6S](#) [MHQ1005P5N1S](#) [MHQ1005P8N2J](#) [PE-51506NL](#) [PE-53601NL](#) [PE-53602NL](#) [PE-](#)
[53630NL](#) [PE-53824SNLT](#) [PE-92100NL](#) [PG0434.801NLT](#) [PG0936.113NLT](#) [9220-20](#) [9310-16](#) [PM06-2N7](#) [PM06-39NJ](#) [A01TK](#) [1206CS-](#)
[471XJ](#) [HC2LP-R47-R](#) [HC2-R47-R](#) [HC3-2R2-R](#) [HC3-R50-R](#) [HC8-1R2-R](#) [HCF1305-3R3-R](#) [1206CS-151XG](#) [RCH664NP-140L](#) [RCH664NP-](#)
[4R7M](#) [RCH8011NP-221L](#) [RCP1317NP-332L](#) [RCP1317NP-391L](#) [RCR1010NP-470M](#) [RCR110DNP-331L](#) [DH2280-4R7M](#) [DS1608C-106](#)
[ASPI-4020HI-R10M-T](#) [B10TJ](#) [B82498B3680J000](#) [ELJ-RE27NJF2](#) [1812CS-153XJ](#) [1812CS-183XJ](#) [1812CS-223XJ](#)