

## 1、订货代码 HOW TO ORDER

举例 For example

XR	0307	—	220	K	P	52	E
↓	↓		↓	↓	↓	↓	↓
A	B		C	D	E	F	G

产品类别 Product type	
XR	轴向色码电感器 Axial color code inductor

C:

标称电感量 Nominal inductance (μH)	
前两位数字为有效数字，后一位数字表示零的个数。	

The first two digits are significant, and the third digit is number of zero.

\* 例如 For example : 101=100μH ;  
5R6=5.6μH R22=0.22μ H

E:

包装方式 Packaging style		
编带 Tape & reel	P	盒带包装 Ammo
	T	卷带包装 Reel
散包装 Bulk	F	直脚轴向 Axial
	L	直脚成型 Straight lead formed
	V	弯脚成型 Bent lead formed
	VK	弯脚 K 型 Bent lead K formed

G:

备注 Remark	
E	无铅 Lead Free
空格 Blank	含铅 Lead Contained



B:

尺寸 Dimensions ( mm )		
类型 Type	外径 D <sub>max</sub>	体长 L <sub>max</sub>
0204	2.3	4.2
0307	2.8	7.0
0410	4.0	10.5
0510	5.0	10.5

D:

感量偏差 Tolerance	
J	±5.0%
K	±10%
M	±20%

F:

引脚形式 Lead configuration		
编带 Tape & reel	26	编带内距 : 26mm Tape width:
	52	编带内距 : 52mm Tape width:
引脚成型 Formed lead	05	引脚脚距 : 5.08mm Formed lead pitch:
	07	引脚脚距 : 7.5mm Formed lead pitch:
	10	引脚脚距 : 10.0mm Formed lead pitch:
	12	引脚脚距 : 12.5mm Formed lead pitch:
	15	引脚脚距 : 15.0mm Formed lead pitch:
	17	引脚脚距 : 17.5mm Formed lead pitch:
	20	引脚脚距 : 20.0mm Formed lead pitch:

## 2、外形尺寸 EXTERNAL DIMENSIONS

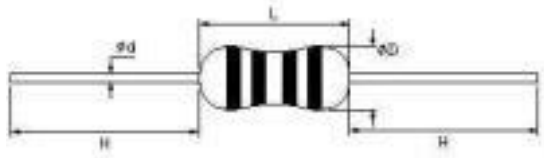
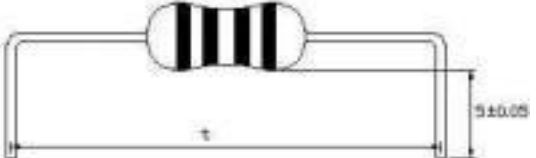
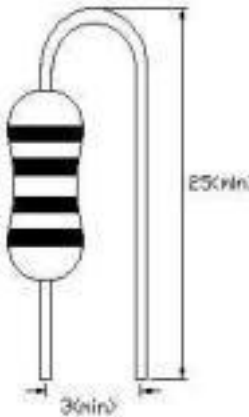
类型 Type	尺寸 Body size ( mm )					 轴向 ( Axial )
	$\phi D \leq$	$L \leq$	t	$\Phi d$	$H \geq$	
XR0204	2.3	4.2	t = 5.08±0.6 t = 7.50±0.6	0.50 ±0.05	20	 直脚成型 ( L type )
XR0307	2.8	7.0	t = 10.0±0.6 t = 12.5±0.6	0.50 ±0.05		 弯脚成型 ( V type )    弯脚 K 型 ( VK type )
XR0410	4.0	10.5	t = 12.5±0.6 t = 15.0±0.6 t = 17.5±0.6 t = 20.0±0.6	0.60 ±0.05		
XR0510	5.0	10.5	t = 15.0±0.6 t = 17.5±0.6 t = 20.0±0.6	0.65 ±0.05		

## 3、产品结构 STRUCTURE

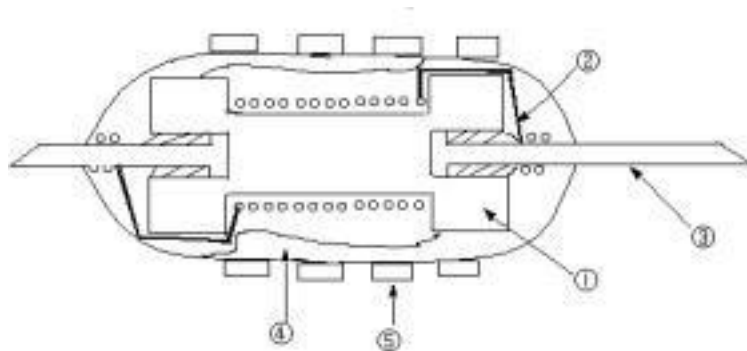

序号 NO.	① 磁芯 Core	② 漆包线 Wire	③ 引脚 Lead	④ 涂覆层 Coating	⑤ 色码 Color code
材料名称 Material name	铁氧体 Ferrite	漆包铜线 Enamelled wire	镀锡铜线 Tinned copper wire	环氧树脂 Epoxy resin	环氧色漆 Epoxy paint for Color coding

## 4、色码标记代号 MARKING

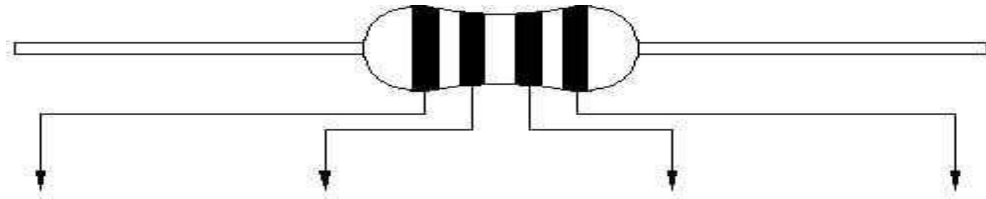

	标称电感量 Nominal inductance ( $\mu\text{H}$ )			感量偏差 Tolerance
	第一色环 1 <sup>st</sup> color zone	第二色环 2 <sup>nd</sup> color zone	第三色环 3 <sup>rd</sup> color zone	第四色环 4 <sup>th</sup> color zone
	第一数字 1 <sup>st</sup> digit	第二数字 2 <sup>nd</sup> digit	第三数字 3 <sup>rd</sup> digit	
黑 Black	0	0	$\times 10^0 ( 1 )$	M : $\pm 20\%$
棕 Brown	1	1	$\times 10^1 ( 10 )$	
红 Red	2	2	$\times 10^2 ( 100 )$	
橙 Orange	3	3	$\times 10^3 ( 1000 )$	
黄 Yellow	4	4	$\times 10^4 ( 10000 )$	
绿 Green	5	5	$\times 10^5 ( 100000 )$	
蓝 Blue	6	6		
紫 Purple	7	7		
灰 Gray	8	8		
白 White	9	9		
金 Gold	/	/	$\times 10^{-1} ( 0.1 )$	J : $\pm 5\%$
银 Silver	/	/	$\times 10^{-2} ( 0.01 )$	K : $\pm 10\%$

\*例如 e.g. :

标称电感量及偏差为 22 $\mu\text{H}$ , $\pm 5\%$ 的电感器其色码为：红+红+黑+金；

If nominal inductance & tolerance is 22 $\mu\text{H}$ , $\pm 5\%$ , respectively red+red+black+gold should be marked;

标称电感量及偏差为 1.0 $\mu\text{H}$ , $\pm 10\%$ 的电感器其色码为：棕+黑+金+银；

If nominal inductance & tolerance is 1.0 $\mu\text{H}$ , $\pm 10\%$ , respectively brown+black+gold+silver should be marked;

标称电感量及偏差为 0.22 $\mu\text{H}$ , $\pm 20\%$ 的电感器其色码为：红+红+银+黑。

If nominal inductance & tolerance is 0.22 $\mu\text{H}$ , $\pm 20\%$ , respectively red+red+silver+black should be marked.

备注：XR0204 由于体长较小，只标注前三条代表标称电感量的色码。

NOTE: Only the first three color zones are marked on the body of XR0204, due to the small body size.

## 5、电性能参数及测试条件

### ELECTRICAL CHARACTERISTICS & TEST CONDITIONS

#### XR0204 型电感器电性能参数及测试条件

#### XR0204 TYPE INDUCTORS ELECTRICAL CHARACTERISTICS & TEST CONDITIONS

XR0204 类型 Type	电感量 Inductance ( $\mu\text{H}$ )	误差 Tolerance	Q ( min )	直流电阻 RDC ( $\Omega$ ) max	测试频率 Test frequency ( MHz )	自谐频率 SRF ( MHz ) min	额定电流 Rated current I <sub>dc</sub> ( mA ) max
XR0204-R22	0.22	M : $\pm 20\%$	35	0.40	25.2	150	400
XR0204-R27	0.27			380			
XR0204-R33	0.33			370			
XR0204-R39	0.39			350			
XR0204-R47	0.47			330			
XR0204-R56	0.56			320			
XR0204-R68	0.68			310			
XR0204-R82	0.82			290			
XR0204-1R0	1.0			270			
XR0204-1R2	1.2			K : $\pm 10\%$			40
XR0204-1R5	1.5	80	250				
XR0204-1R8	1.8	60	240				
XR0204-2R2	2.2	45	230				
XR0204-2R7	2.7	40	220				
XR0204-3R3	3.3	38	210				
XR0204-3R9	3.9	35	200				
XR0204-4R7	4.7	32	190				
XR0204-5R6	5.6	30	180				
XR0204-6R8	6.8	28	175				
XR0204-8R2	8.2	26	165				
XR0204-100	10	24	160				
XR0204-120	12	22	150				
XR0204-150	15	20	145				
XR0204-180	18	18	140				
XR0204-220	22	17	130				
XR0204-270	27	16	80				
XR0204-330	33	14	76				
XR0204-390	39	13	73				
XR0204-470	47	12	70				
XR0204-560	56	11	68				
XR0204-680	68	10	64				
XR0204-820	82	9.5	46				
XR0204-101	100	9.0	44				
XR0204-121	120	13.0	42				
XR0204-151	150	16.0	39				
XR0204-181	180	18.0	37				
XR0204-221	220	20.0	35				
测试仪器 Test equipment	HP4285A (HP4286A , HP4287A)			HP4338B		HM9461	HP42841A
环境温度 Ambient temperature	18 ~ 25°C						
环境湿度 Ambient humidity	45%~75%						

# 特殊要求的产品可以根据客户要求生产

The products can be customized according to customer requirement.

XR0307 型电感器电性能参数及测试条件  
 XR0307 TYPE INDUCTORS ELECTRICAL CHARACTERISTICS & TEST CONDITIONS

XR0307 类型 Type	电感量 Inductance ( $\mu\text{H}$ )	误差 Tolerance	Q ( min )	直流电阻 RDC ( $\Omega$ ) max	测试频率 Test frequency ( MHz )	自谐频率 SRF ( MHz ) min	额定电流 Rated current $I_{DC}$ ( mA ) max
XR0307-R22	0.22	M : $\pm 20\%$	35	0.40	25.2	150	400
XR0307-R27	0.27			0.43			380
XR0307-R33	0.33			0.48			370
XR0307-R39	0.39			0.51			350
XR0307-R47	0.47			0.56			330
XR0307-R56	0.56		0.61	320			
XR0307-R68	0.68		0.67	310			
XR0307-R82	0.82		0.74	290			
XR0307-1R0	1.0		0.80	270			
XR0307-1R2	1.2		0.90	260			
XR0307-1R5	1.5		1.0	250			
XR0307-1R8	1.8		1.1	240			
XR0307-2R2	2.2		1.2	230			
XR0307-2R7	2.7		1.3	220			
XR0307-3R3	3.3		1.4	210			
XR0307-3R9	3.9		1.6	200			
XR0307-4R7	4.7		1.7	190			
XR0307-5R6	5.6		1.9	180			
XR0307-6R8	6.8		2.0	175			
XR0307-8R2	8.2		2.2	165			
XR0307-100	10	2.5	160				
XR0307-120	12	2.5	150				
XR0307-150	15	2.8	145				
XR0307-180	18	3.1	140				
XR0307-220	22	3.4	130				
XR0307-270	27	3.8	125				
XR0307-330	33	4.1	120				
XR0307-390	39	4.5	115				
XR0307-470	47	4.9	110				
XR0307-560	56	5.3	105				
XR0307-680	68	5.8	100				
XR0307-820	82	6.3	95				
XR0307-101	100	7.0	90				
XR0307-121	120	13.0	90				
XR0307-151	150	15.0	85				
XR0307-181	180	16.0	80				
XR0307-221	220	17.0	75				
XR0307-271	270	19.0	65				
XR0307-331	330	20.0	60				
XR0307-391	390	22.0	55				
XR0307-471	470	24.0	55				
XR0307-561	560	26.0	50				
XR0307-681	680	28.0	45				
XR0307-821	820	30.0	40				
XR0307-102	1000	33.0	40				
测试仪器 Test equipment	HP4285A (HP4286A , HP4287A)			HP4338B		HM9461	HP42841A
环境温度 Ambient temperature	18 ~ 25°C						
环境湿度 Ambient humidity	45%~75%						

# 特殊要求的产品可以根据客户要求生产  
 The products can be customized according to customer requirement.

## XR0410 型电感器电性能参数及测试条件

## XR0410 TYPE INDUCTORS ELECTRICAL CHARACTERISTICS &amp; TEST CONDITIONS

XR0410 类型 Type	电感量 Inductance ( $\mu\text{H}$ )	误差 Tolerance	Q (min)	直流电阻 RDC ( $\Omega$ ) max	测试频率 Test frequency (MHz)	自谐频率 SRF (MHz) min	额定电流 Rated current $I_{DC}$ (mA) max
XR0410-R22	0.22	M : $\pm 20\%$	45	0.10	25.2	300	1400
XR0410-R27	0.27		45	0.11		270	1320
XR0410-R33	0.33		45	0.12		250	1280
XR0410-R39	0.39		45	0.13		230	1200
XR0410-R47	0.47		45	0.14		220	1150
XR0410-R56	0.56		45	0.15		200	1122
XR0410-R68	0.68		45	0.16		190	1030
XR0410-R82	0.82		45	0.17		172	980
XR0410-1R0	1.0		45	0.19		157	920
XR0410-1R2	1.2		50	0.21		144	880
XR0410-1R5	1.5		50	0.23	131	830	
XR0410-1R8	1.8		55	0.25	121	790	
XR0410-2R2	2.2		55	0.28	110	750	
XR0410-2R7	2.7		60	0.30	100	720	
XR0410-3R3	3.3		65	0.34	94	670	
XR0410-3R9	3.9		65	0.37	65	640	
XR0410-4R7	4.7		70	0.39	56	620	
XR0410-5R6	5.6		70	0.43	48	590	
XR0410-6R8	6.8		75	0.48	37	550	
XR0410-8R2	8.2		80	0.52	25	530	
XR0410-100	10	65	0.58	21	500		
XR0410-120	12	50	0.63	19	480		
XR0410-150	15	50	0.72	17	460		
XR0410-180	18	50	0.77	13	430		
XR0410-220	22	50	0.84	9.6	410		
XR0410-270	27	55	0.94	7.2	390		
XR0410-330	33	55	1.03	6.3	370		
XR0410-390	39	50	1.12	6.3	350		
XR0410-470	47	45	1.22	6.3	340		
XR0410-560	56	40	1.34	6.2	320		
XR0410-680	68	40	1.47	5.7	305		
XR0410-820	82	35	1.62	5.3	290		
XR0410-101	100	30	1.80	4.8	275		
XR0410-121	120	55	3.70	3.8	185		
XR0410-151	150	45	4.20	3.5	175		
XR0410-181	180	50	4.60	3.3	165		
XR0410-221	220	55	5.10	3.0	155		
XR0410-271	270	65	5.80	2.8	145		
XR0410-331	330	65	6.40	2.6	137		
XR0410-391	390	65	7.00	2.4	133		
XR0410-471	470	60	7.70	2.25	126		
XR0410-561	560	60	8.50	2.10	120		
XR0410-681	680	55	9.40	1.95	113		
XR0410-821	820	55	10.50	1.85	105		
XR0410-102	1000	50	14.00	1.40	100		
XR0410-152	1500	30	25.00	0.252	1.10	85	
XR0410-222	2200	30	35.00	0.252	0.80	75	
测试仪器 Test equipment	HP4285A (HP4286A ,HP4287A)		HP4338B		HM9461		HP42841A
环境温度 Ambient temperature	18 ~ 25°C						
环境湿度 Ambient humidity	45%~75%						

# 特殊要求的产品可以根据客户要求生产

The products can be customized according to customer requiremen

XR0510 型电感器电性能参数及测试条件  
 XR0510 TYPE INDUCTORS ELECTRICAL CHARACTERISTICS & TEST CONDITIONS

XR0510 类型 Type	电感量 Inductance ( $\mu\text{H}$ )	误差 Tolerance	Q (min)	直流电阻 RDC ( $\Omega$ ) max	测试频率 Test frequency (MHz)	自谐频率 SRF (MHz) min	额定电流 Rated current $I_{DC}$ (mA) max	
XR0510-2R2	2.2	M: $\pm 20\%$	10	0.26	7.96	50	2100	
XR0510-3R3	3.3		10	0.3		50	1800	
XR0510-3R9	3.9		10	0.35		50	1500	
XR0510-4R7	4.7		20	0.43		50	900	
XR0510-6R8	6.8		15	0.45		45	850	
XR0510-100	10		15	0.45		30	750	
XR0510-120	12		30	0.6		30	700	
XR0510-150	15		30	0.65		30	650	
XR0510-180	18		30	0.65		30	600	
XR0510-220	22		K: $\pm 10\%$	30	0.65	2.52	8	550
XR0510-270	27			30	0.65		7	500
XR0510-330	33			30	0.65		6	470
XR0510-390	39			30	0.65		6	460
XR0510-470	47			30	0.8		5	430
XR0510-560	56			30	0.8		5	430
XR0510-680	68			30	0.8		4.5	430
XR0510-820	82			30	0.82		3.8	430
XR0510-101	100			30	0.9		3.5	400
XR0510-121	120	30		0.92	3.3	390		
XR0510-151	150	30		0.92	3.2	390		
XR0510-181	180	30		0.94	2.8	390		
XR0510-221	220	30		0.94	2.6	380		
XR0510-271	270	30		1	2.4	380		
XR0510-331	330	30		1.11	2.2	380		
XR0510-391	390	30		1.12	2	350		
XR0510-471	470	J: $\pm 5\%$		45	1.22	0.796	1.9	340
XR0510-561	560			40	1.34		1.8	320
XR0510-681	680		40	1.47	1.5		305	
XR0510-821	820		35	1.62	1.3		290	
XR0510-102	1000		45	14	1		100	
XR0510-122	1200		40	16.9	0.95		95	
XR0510-152	1500		40	21.6	0.9		90	
XR0510-182	1800		40	24	0.85		85	
XR0510-222	2200		40	34.7	0.8		80	
XR0510-272	2700		40	40	0.75	75		
XR0510-332	3300		40	59.5	0.7	62		
XR0510-392	3900		40	66	0.65	59		
XR0510-472	4700		40	74	0.6	55		
XR0510-562	5600		30	80	0.5	40		
XR0510-682	6800		30	85	0.45	35		
XR0510-822	8200		30	95	0.4	30		
XR0510-103	10000		50	14	0.0796	1.4	100	
测试仪器 Test equipment	HP4285A (HP4286A ,HP4287A)			HP4338B		HM9461	HP42841A	
环境温度 Ambient temperature	18 ~ 25°C							
环境湿度 Ambient humidity	45%~75%							

# 特殊要求的产品可以根据客户要求生产

The products can be customized according to customer requirement.

## 6、包装方式 PACKAGING STYLE

- 编带尺寸 Taping dimensions

单位 Unit : mm

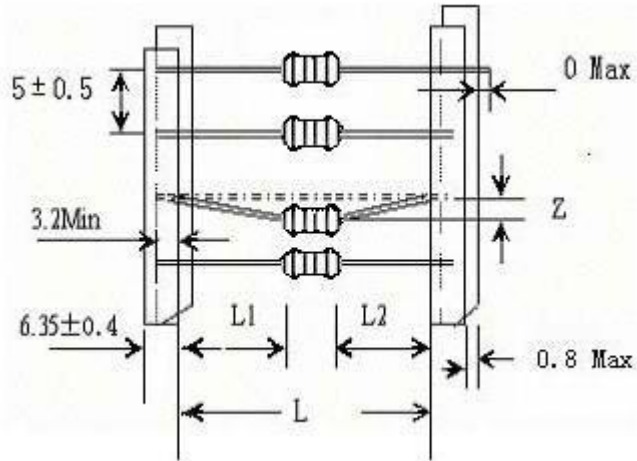

编带方式 Tape style	L	Z	L1-L2
编带内距:26 Tape width	$26 \pm 1.0$	0.8 Max	1.0 Max
编带内距:52 Tape width	$52 \begin{smallmatrix} +2.0 \\ -1.0 \end{smallmatrix}$	1.2 Max	

- 卷带包装尺寸 Tape & reel packaging dimensions

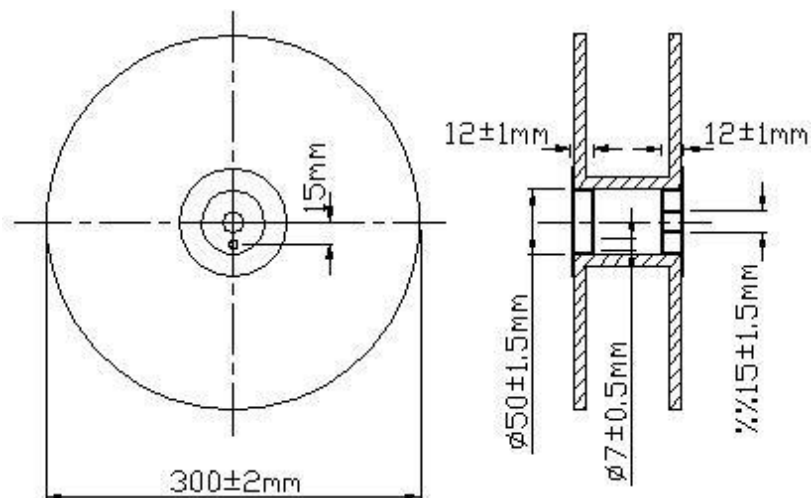



- 盒带包装尺寸 Ammo packaging dimensions

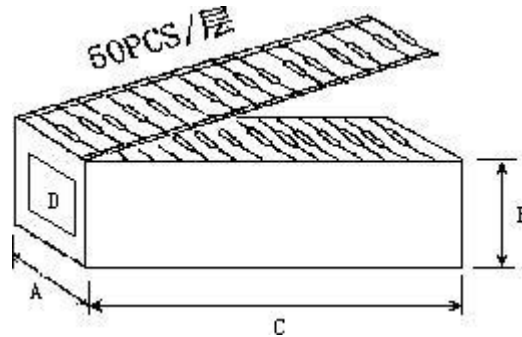

- 包装盒尺寸 Dimensions of box

单位 Unit : mm

编带类型 Tape type	尺寸 Dimensions ( ±5mm )		
	A	B	C
52	75	82	260
26	50	82	260

- 包装数量 Packaging quantity

包装方式 Packaging style	盒带包装 Ammo	卷带包装 Tape & reel	散包装 Bulk
包装数量 Quantity	2000	2000	1000

# 可根据用户需求包装

Packaging according to customer's requirement

## X-ON Electronics

Largest Supplier of Electrical and Electronic Components

*Click to view similar products for [Fixed Inductors](#) category:*

*Click to view products by [MaxLinear](#) manufacturer:*

Other Similar products are found below :

[CR43NP-680KC](#) [CR54NP-470LC](#) [CR54NP-820KC](#) [CR54NP-8R5MC](#) [70F224AI](#) [MGDQ4-00004-P](#) [MHL1ECTTP18NJ](#) [MHQ1005P10NJ](#)  
[MHQ1005P1N0S](#) [MHQ1005P2N4S](#) [MHQ1005P3N6S](#) [MHQ1005P5N1S](#) [MHQ1005P8N2J](#) [PE-51506NL](#) [PE-53601NL](#) [PE-53602NL](#) [PE-](#)  
[53630NL](#) [PE-53824SNLT](#) [PE-92100NL](#) [PG0434.801NLT](#) [PG0936.113NLT](#) [9220-20](#) [9310-16](#) [PM06-2N7](#) [PM06-39NJ](#) [A01TK](#) [1206CS-](#)  
[471XJ](#) [HC2LP-R47-R](#) [HC2-R47-R](#) [HC3-2R2-R](#) [HC3-R50-R](#) [HC8-1R2-R](#) [HCF1305-3R3-R](#) [1206CS-151XG](#) [RCH664NP-140L](#) [RCH664NP-](#)  
[4R7M](#) [RCH8011NP-221L](#) [RCP1317NP-332L](#) [RCP1317NP-391L](#) [RCR1010NP-470M](#) [RCR110DNP-331L](#) [DH2280-4R7M](#) [DS1608C-106](#)  
[ASPI-4020HI-R10M-T](#) [B10TJ](#) [B82498B3680J000](#) [ELJ-RE27NJF2](#) [1812CS-153XJ](#) [1812CS-183XJ](#) [1812CS-223XJ](#)