

8A and 12A Synchronous Step Down COT Regulators

General Description

The [XR76108](#) and [XR76112](#) are synchronous step-down regulators combining the controller, drivers, bootstrap diode and MOSFETs in a single package for Point-of-Load supplies. The XR76108 has a load current rating of 8A and the XR76112 has a load current rating of 12A. A wide 4.5V to 22V input voltage range allows for single supply operation from industry standard 5V, 12V and 19.6V rails.

With a proprietary emulated current mode Constant On-Time (COT) control scheme, the XR76108 and XR76112 provide extremely fast line and load transient response using ceramic output capacitors. They require no loop compensation, simplifying circuit implementation and reducing overall component count. The control loop also provides 0.25% load and 0.1% line regulation and maintains constant operating frequency. A selectable power saving mode allows the user to operate in discontinuous mode (DCM) at light current loads, thereby significantly increasing the converter efficiency.

A host of protection features, including over-current, over-temperature, short-circuit and UVLO, help achieve safe operation under abnormal operating conditions.

The XR76108 and XR76112 are available in a RoHS-compliant, green / halogen-free, space-saving QFN 5x5mm package.

FEATURES

- 8A and 12A capable step down regulators
 - 4.5V to 5.5V low V_{IN} operation
 - 4.5V to 22V wide single input voltage
 - $\geq 0.6V$ adjustable output voltage
- Controller, drivers, bootstrap diode and MOSFETs integrated in one package
- Proprietary Constant On-Time control
 - No loop compensation required
 - Ceramic output capacitor stable operation
 - Programmable 200ns - 2 μ s on-time
 - Constant 200kHz - 800kHz frequency
 - Selectable CCM or CCM / DCM operation
- Precision enable and Power-Good flag
- Programmable soft-start
- 5x5mm 30-pin QFN package

APPLICATIONS

- Distributed power architecture
- Point-of-Load converters
- Power supply modules
- FPGA, DSP, and processor supplies
- Base stations, switches / routers, and servers

Typical Application

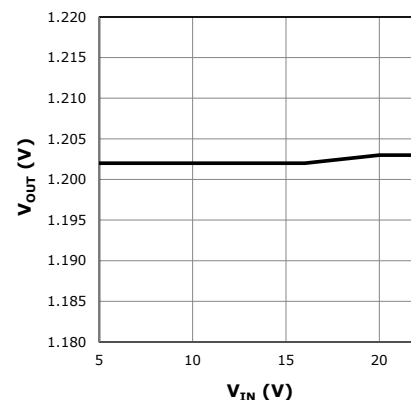
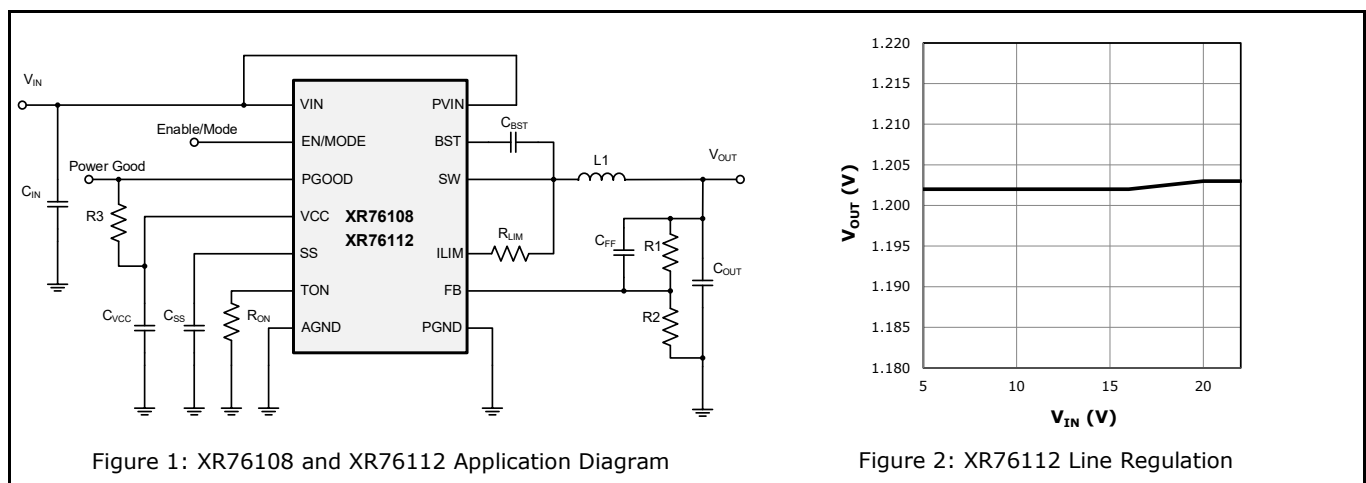

Absolute Maximum Ratings

These are stress ratings only and functional operation of the device at these ratings or any other above those indicated in the operation sections of the specifications below is not implied. Stresses beyond those listed under Absolute Maximum Ratings may cause permanent damage to the device. Exposure to any Absolute Maximum Rating condition for extended periods may affect device reliability and lifetime.

PV _{IN} , V _{IN}	-0.3V to 25V
V _{CC}	-0.3V to 6.0V
BST	-0.3V to 31V ⁽¹⁾
BST-SW	-0.3V to 6V
SW, I _{LIM}	-1V to 25V ^(1,2)
All other pins	-0.3V to V _{CC} +0.3V
Storage temperature	-65°C to 150°C
Junction temperature	150°C
Power dissipation	Internally Limited
Lead temperature (soldering, 10 sec).....	300°C
ESD Rating (HBM – Human Body Model)	2kV
ESD Rating (CDM – Charged Device Model)	1.5kV

Operating Ratings

PV _{IN}	3V to 22V
V _{IN}	4.5V to 22V
V _{CC}	4.5V to 5.5V
SW, I _{LIM}	-1V to 22V ⁽²⁾
PGOOD, V _{CC} , T _{ON} , SS, EN.....	-0.3V to 5.5V
Switching frequency	200kHz-800kHz ⁽³⁾
Junction temperature range (T _J)	-40°C to 125°C
XR76108 package power dissipation max at 25°C	3.8W
XR76112 package power dissipation max at 25°C	4.1W
XR76108 JEDEC51 package thermal resistance θ _{JA}	26°C/W
XR76112 JEDEC51 package thermal resistance θ _{JA}	24°C/W

Note 1: No external voltage applied

Note 2: SW pin's DC range is -1V, transient is -5V for less than 50ns

Note 3: Recommended

Ordering Information⁽¹⁾

Part Number	Operating Temperature Range	Package	Packing Method	Lead-Free ⁽²⁾
XR76108ELTR-F	-40°C ≤ T _J ≤ +125°C	5x5mm QFN	Tape & Reel	Yes
XR76112EL-F	-40°C ≤ T _J ≤ +125°C	5x5mm QFN	Bulk	Yes
XR76112ELTR-F	-40°C ≤ T _J ≤ +125°C	5x5mm QFN	Tape & Reel	Yes
XR76108EVB	XR76108 Evaluation Board			
XR76112EVB	XR76112 Evaluation Board			

NOTES:

1. Refer to www.maxlinear.com/XR76108, www.maxlinear.com/XR76112 for most up-to-date Ordering Information.
2. Visit www.maxlinear.com for additional information on Environmental Rating.

Electrical Characteristics

Specifications are for the operating junction temperature of T_J = 25°C only; limits applying over the full operating junction temperature range are denoted by a “*”. Typical values represent the most likely parametric norm at T_J = 25°C, and are provided for reference purposes only. Unless otherwise indicated, V_{IN}=12V.

Parameter	Min.	Typ.	Max.	Units	Conditions
Power Supply Characteristics					
V _{IN} , input voltage range	4.5	12	22	V	V _{CC} regulating or in dropout
	4.5	5.0	5.5		V _{CC} tied to V _{IN}
I _{VIN} , V _{IN} supply current		0.7	1.3	mA	• Not switching, V _{IN} = 12V, V _{FB} = 0.7V
I _{VCC} , V _{CC} quiescent current		0.7	1.3	mA	• Not switching, V _{CC} = V _{IN} = 5V, V _{FB} = 0.7V
I _{VIN} , V _{IN} supply current (XR76112)		8		mA	f = 300kHz, R _{ON} = 107k, V _{FB} = 0.58V
I _{VIN} , V _{IN} supply current (XR76108)		6		mA	f = 300kHz, R _{ON} = 107k, V _{FB} = 0.58V
I _{OFF} , shutdown current		0.5		µA	Enable = 0V, V _{IN} = 12V, V _{IN} = PV _{IN}
Enable and Under-Voltage Lock-Out UVLO					
V _{IH_EN} , EN pin rising threshold	1.8	1.9	2.0	V	•
V _{EN_HYS} , EN pin hysteresis		50		mV	
V _{IH_EN} , EN pin rising threshold for DCM/CCM operation	2.8	3.0	3.1	V	•

Parameter	Min.	Typ.	Max.	Units	Conditions
V _{EN_HYS} , EN pin hysteresis		100		mV	
V _{CC} UVLO start threshold, rising edge	4.00	4.25	4.40	V	•
V _{CC} UVLO hysteresis	150	230		mV	•
Reference Voltage					
V _{REF} , reference voltage	0.597	0.600	0.603	V	V _{IN} = 4.5V - 22V → V _{CC} regulating or in dropout
	0.596	0.600	0.604	V	V _{IN} = 4.5V - 5.5V → V _{CC} tied to V _{IN}
	0.594	0.600	0.606	V	• V _{IN} = 4.5V - 22V → V _{CC} regulating or in dropout, V _{IN} = 4.5V - 5.5V → V _{CC} tied to V _{IN}
DC load regulation		±0.25		%	CCM operation, closed loop, applies to any C _{OUT}
DC Line regulation		±0.1		%	
Parameter	Min.	Typ.	Max.	Units	Conditions
Programmable Constant On-Time					
On-time 1	1.66	1.95	2.24	µs	• R _{ON} = 140kΩ, V _{IN} = 22V
f corresponding to on-time 1	243	280	329	kHz	V _{IN} = 22V, V _{OUT} = 12V
Minimum Programmable on-time		109		ns	R _{ON} = 6.98kΩ, V _{IN} = 22V
On-time 2	162	202	226	ns	• R _{ON} = 6.98kΩ, V _{IN} = 12V
f corresponding to on-time 2	1217	1361	1698	kHz	V _{OUT} = 3.3V
f corresponding to on-time 2	369	413	514	kHz	V _{OUT} = 1.0V
On-time 3	352	422	492	ns	• R _{ON} = 16.2kΩ, V _{IN} = 12V
Minimum off-time		250	350	ns	•
Diode Emulation Mode					
Zero crossing threshold		-2		mV	DC value measured during test
Soft-Start					
SS charge current	-14	-10	-6	µA	•
SS discharge current	1	3		mA	• Fault present
V_{CC} Linear Regulator					
V _{CC} output voltage	4.8	5.0	5.2	V	• V _{IN} = 6V to 22V, I _{load} = 0 to 30mA
	4.3	4.37			• V _{IN} = 4.5V, R _{ON} = 16.2kΩ, f _{sw} = 678kHz, XR76112
Power Good Output					
Power Good threshold	-10	-7.5	-5	%	
Power Good hysteresis		2	4	%	
Power Good sink current	1	15		mA	
Protection: OCP, OTP, Short-Circuit					
Hiccup timeout		110		ms	
I _{LIM} pin source current	45	50	55	µA	
I _{LIM} current temperature coefficient		0.4		%/°C	
I _{LIM} comparator offset	-8	0	+8	mV	•
Current limit blanking		100		ns	
Thermal shutdown threshold		150		°C	Rising temperature
Thermal hysteresis		15		°C	
Feedback pin short-circuit threshold	50	60	70	%	• Percent of V _{REF} , short circuit is active After PGOOD is up
XR76108 Output Power Stage					
High-side MOSFET R _{DS(on)}		21	28	mΩ	V _{GS} = 4.5V, I _{DS} = 2A
Low-side MOSFET R _{DS(on)}		7	10	mΩ	V _{GS} = 4.5V, I _{DS} = 2A
Maximum output current	8			A	•
XR76112 Output Power Stage					
High-side MOSFET R _{DS(on)}		11	15.5	mΩ	V _{GS} = 4.5V, I _{DS} = 2A
Low-side MOSFET R _{DS(on)}		5	9	mΩ	V _{GS} = 4.5V, I _{DS} = 2A
Maximum output current	12			A	•

Block Diagram

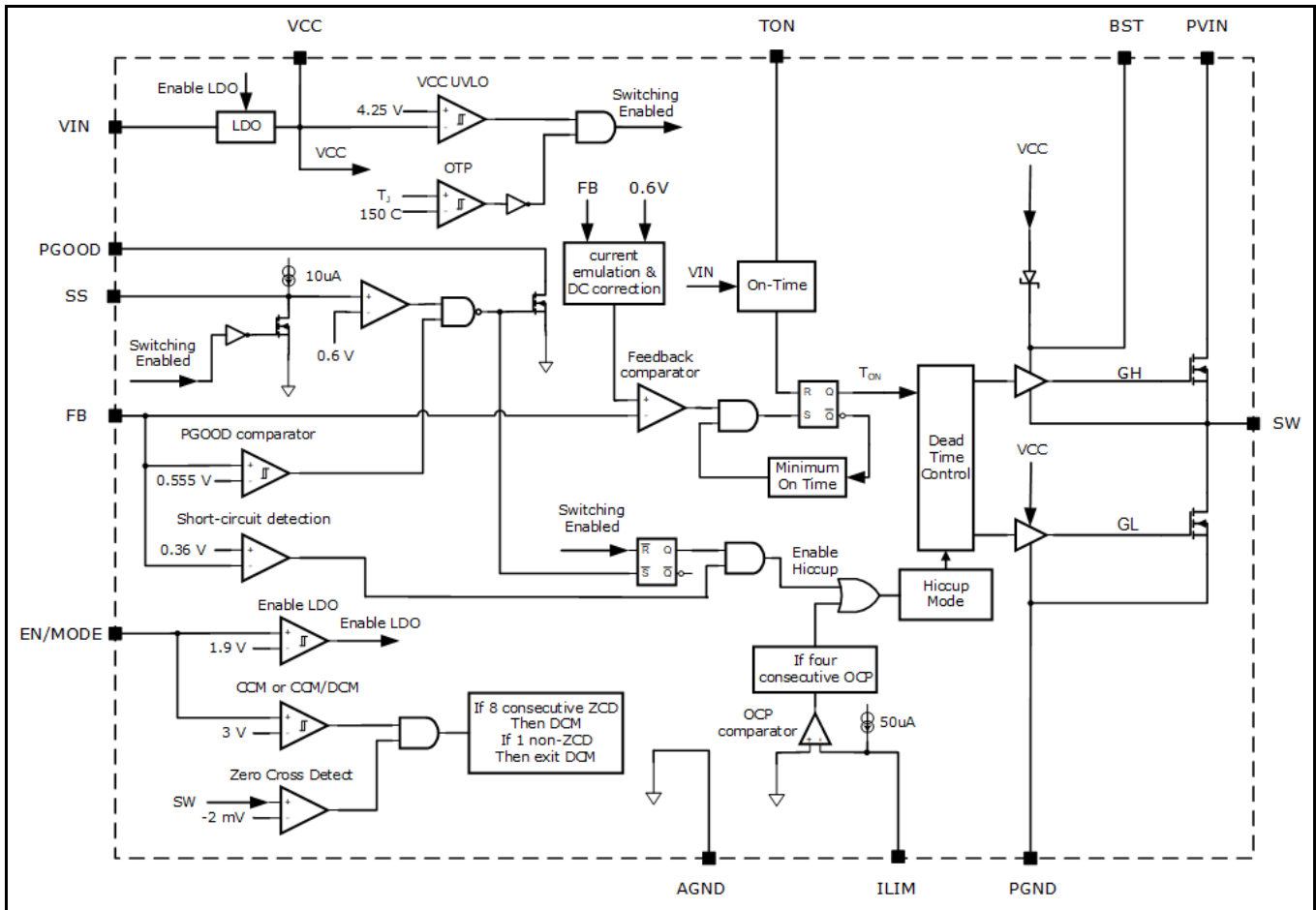

Figure 3: XR76108 / XR76112 Block Diagram

Pin Assignment

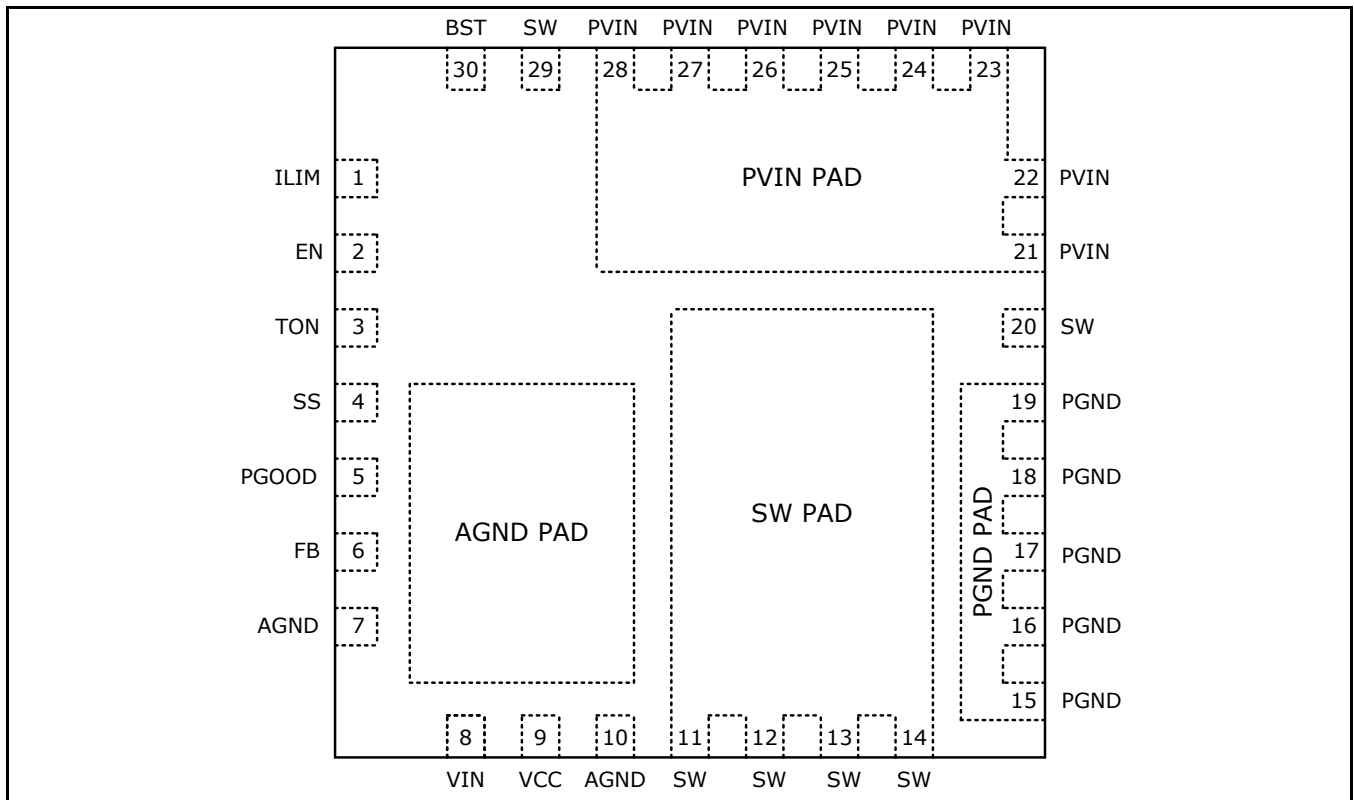

Figure 4: XR76108 / XR76112 Pin Assignment

Pin Description

Name	Pin Number	Description
ILIM	1	Over-current protection programming. Connect with a resistor to SW.
EN/MODE	2	Precision enable pin. Pulling this pin above 1.9V will turn the regulator on and it will operate in CCM. If the voltage is raised above 3.0V, then the regulator will operate in DCM / CCM, depending on load.
TON	3	Constant On-Time programming pin. Connect with a resistor to AGND.
SS	4	Soft-start pin. Connect an external capacitor between SS and AGND to program the soft-start rate based on the 10 μ A internal source current.
PGOOD	5	Power-good output. This open-drain output is pulled low when V _{OUT} is outside the regulation.
FB	6	Feedback input to feedback comparator. Connect with a set of resistors to V _{OUT} and AGND in order to program V _{OUT} .
AGND	7, 10, AGND Pad	Signal ground for control circuitry. Connect AGND Pad with a short trace to pins 7 and 10.
VIN	8	Supply input for the regulator's LDO. Normally it is connected to PVIN.
VCC	9	The output of regulator's LDO. For operation using a 5V rail, VCC should be shorted to VIN.
SW	11-14, 20, 29, SW Pad	Switch node. The drain of the low-side N-channel MOSFET. The source of the high-side MOSFET is wire-bonded to the SW Pad. Pins 20 and 29 are internally connected to the SW pad.
PGND	15-19, PGND Pad	Ground of the power stage. Should be connected to the system's power ground plane. The source of the low-side MOSFET is wire-bonded to PGND Pad.
PVIN	21-28, PVIN Pad	Input voltage for power stage. The drain of the high-side N-channel MOSFET.
BST	30	High-side driver supply pin. Connect a bootstrap capacitor between BST and pin 29.

Typical Performance Characteristics

All data taken at $V_{IN} = 12V$, $V_{OUT} = 1.2V$, $f = 600kHz$, $T_A = 25^\circ C$, no Air flow, Forced CCM, unless otherwise specified. The schematic and BOM are from the Applications Circuit section of this datasheet.

REGULATION

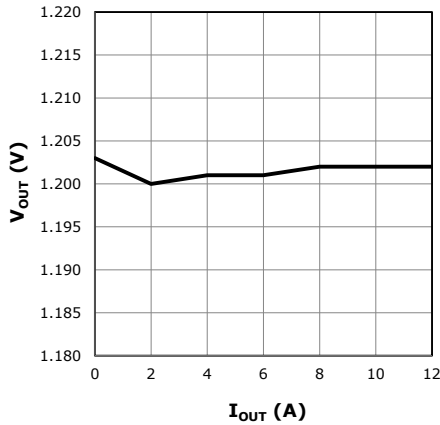

Figure 5: XR76112 Load Regulation, $V_{IN}=12V$

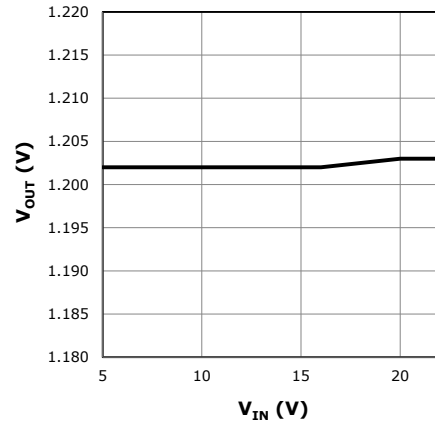

Figure 6: XR76112 Line Regulation, $I_{OUT}=12A$

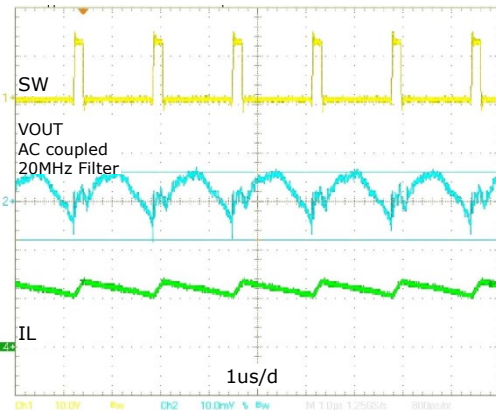

Figure 7: XR76112 V_{OUT} Ripple is 14mV at 12A

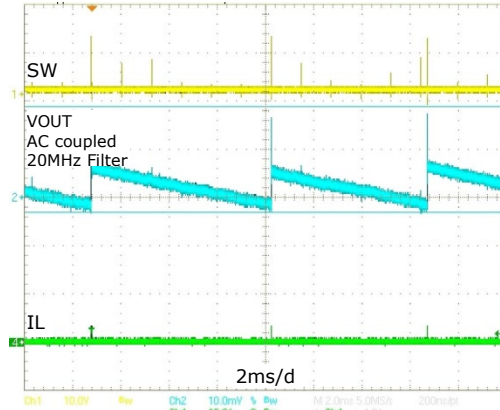

Figure 8: XR76112 V_{OUT} Ripple is 22mV at 0A, DCM

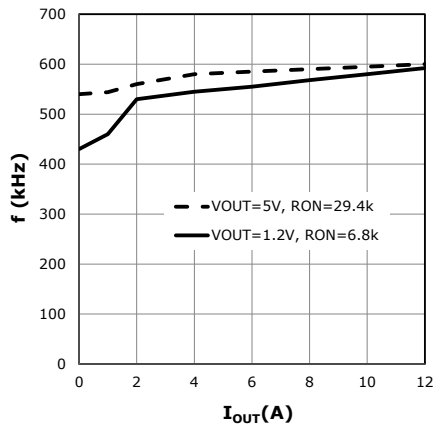

Figure 9: XR76112 Frequency vs. I_{OUT} , Forced CCM

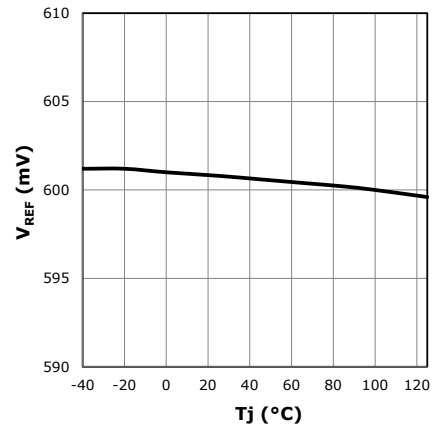

Figure 10: V_{REF} vs. Temperature

Typical Performance Characteristics

All data taken at $V_{IN} = 12V$, $V_{OUT} = 1.2V$, $f = 600kHz$, $T_A = 25^\circ C$, no Air flow, Forced CCM, unless otherwise specified. The schematic and BOM are from the Applications Circuit section of this datasheet.

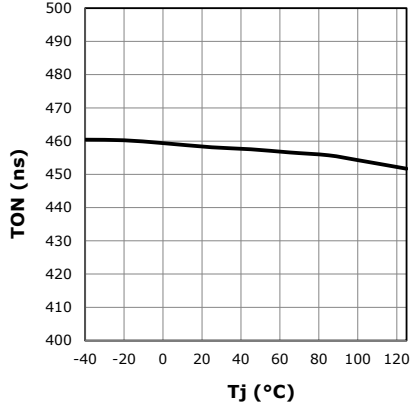

Figure 11: On-Time vs. Temperature

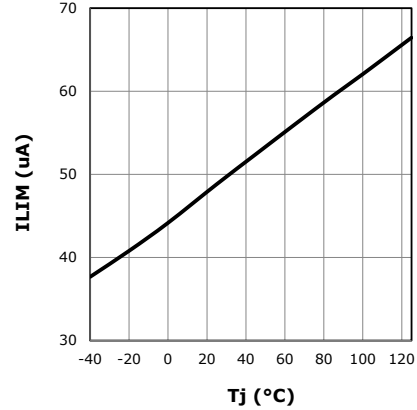

Figure 12: ILLIM vs. Temperature

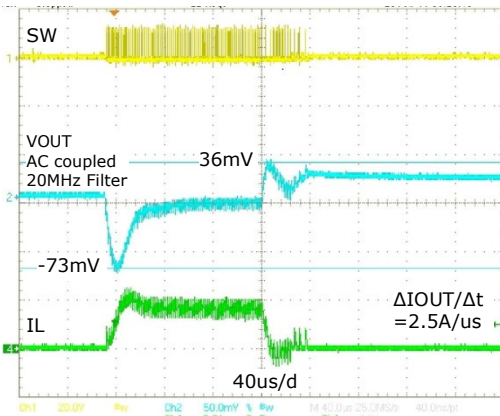

Figure 13: XR76108 Load Step, DCM/CCM, 0A - 4A - 0A

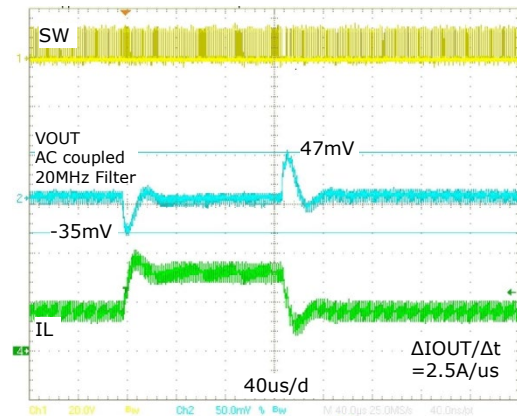

Figure 14: XR76108 Load Step, Forced CCM, 4A - 8 - 4A

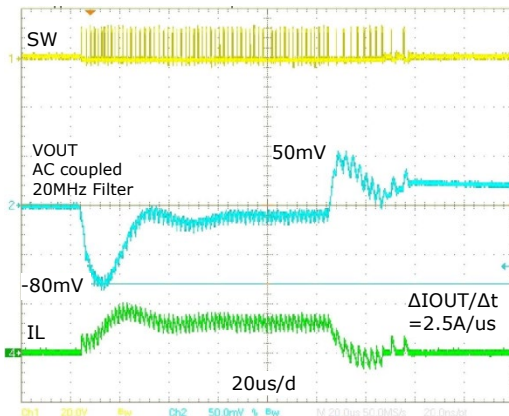

Figure 15: XR76112 Load Step, DCM / CCM, 0A - 6A - 0A

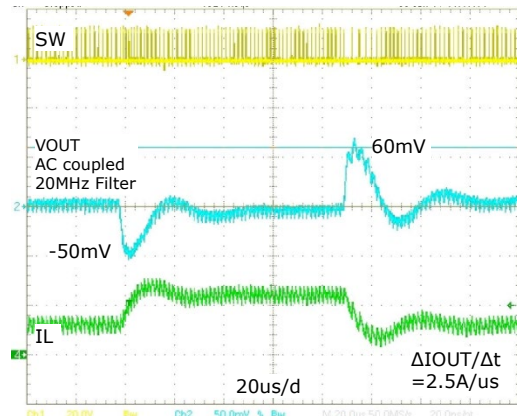

Figure 16: XR76112 Load Step, Forced CCM, 6A - 12A - 6A

Power-Up

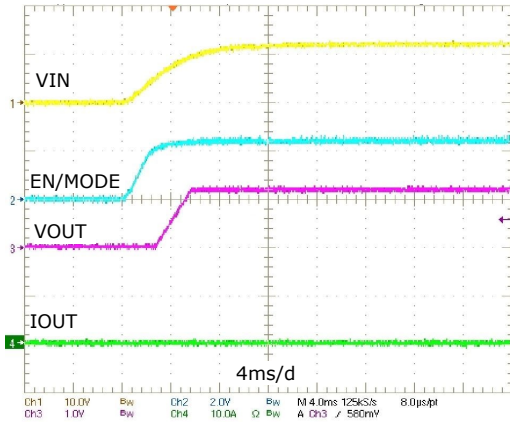

Figure 17: XR76112 Power-up, Forced CCM, $I_{OUT} = 0A$

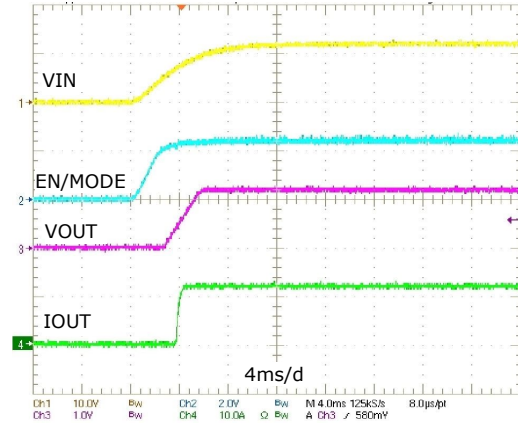

Figure 18: XR76112 Power-up, Forced CCM, $I_{OUT} = 12A$

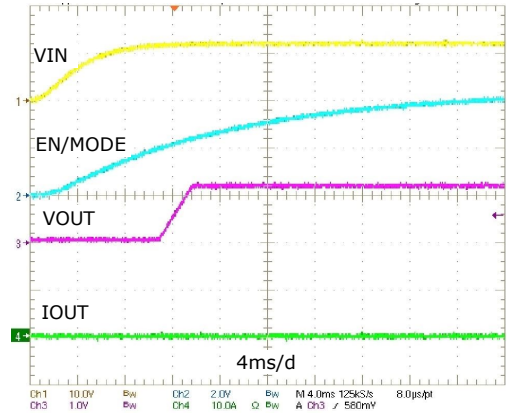

Figure 19: XR76112 Power-up, DCM / CCM, $I_{OUT} = 0A$

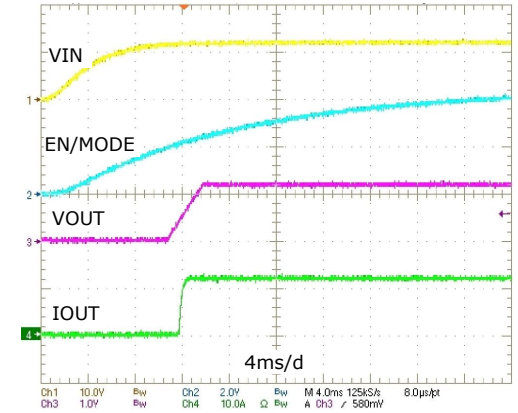

Figure 20: XR76112 Power-up, DCM / CCM, $I_{OUT} = 12A$

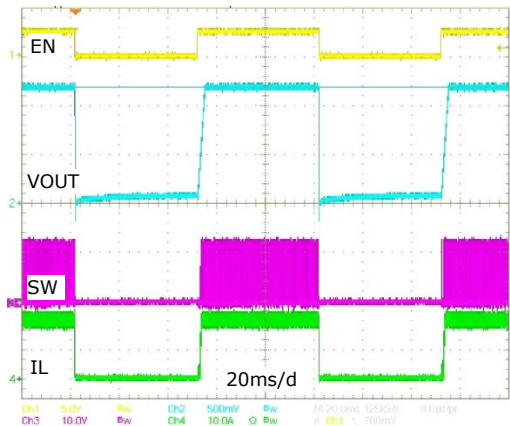

Figure 21: XR76112 Enable Turn On / Turn Off, $1.2V_{OUT}$, 12A

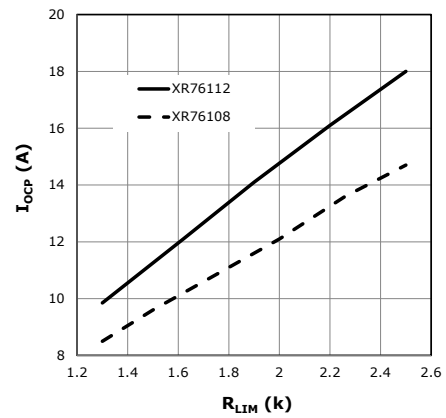

Figure 22: Typical I_{OCp} versus R_{LIM}

Efficiency – XR76108/ XR76112

T_{AMBIENT} = 25°C, no Air flow, inductor losses are included.

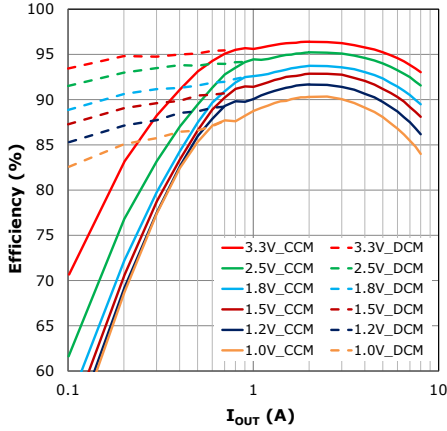

Figure 23: XR76108, 5V_{IN}, 600kHz, 1µH

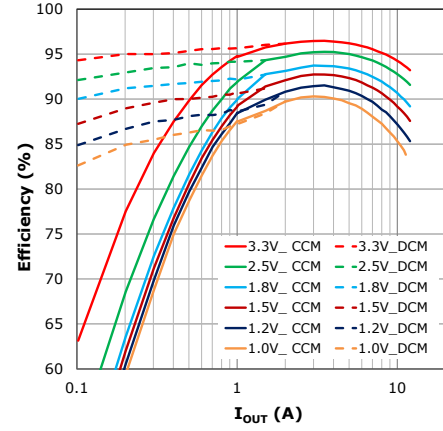

Figure 24: XR76112, 5V_{IN}, 600kHz, 0.56µH

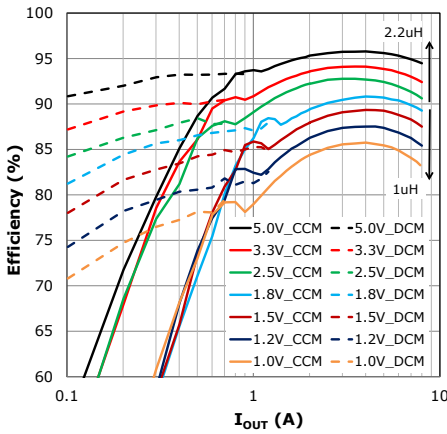

Figure 25: XR76108, 12V_{IN}, 600kHz

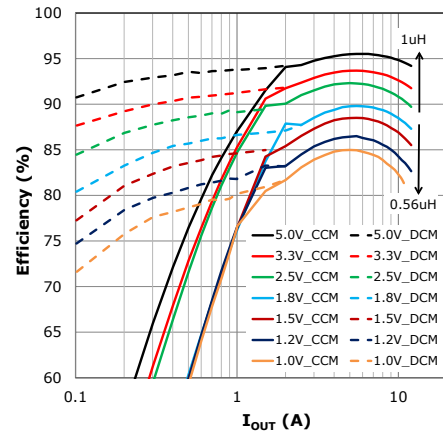

Figure 26: XR76112, 12V_{IN}, 600kHz

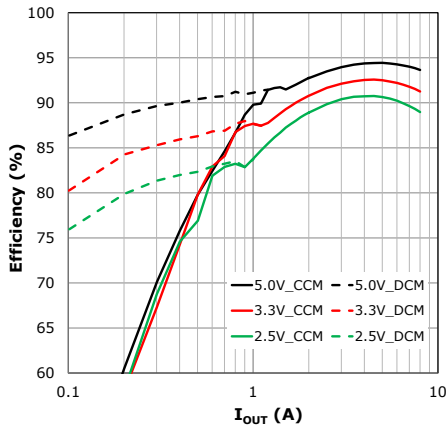

Figure 27: XR76108, 22V_{IN}, 400kHz, 3.3µH

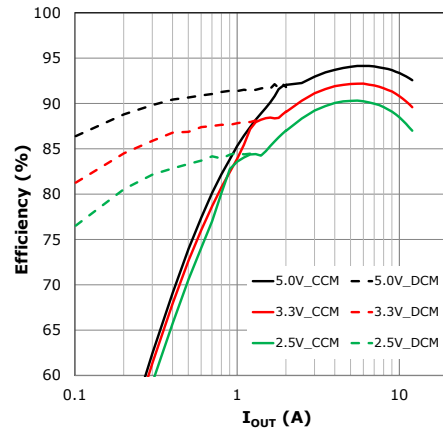

Figure 28: XR76112, 22V_{IN}, 400kHz, 2.2µH

Thermal Characteristics

No Air flow, $f = 600\text{kHz}$

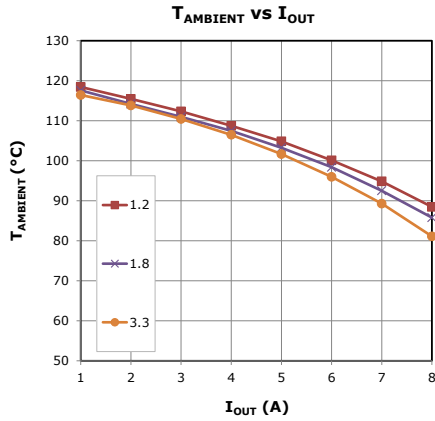

Figure 29: XR76108 Package Thermal Derating, 12VIN

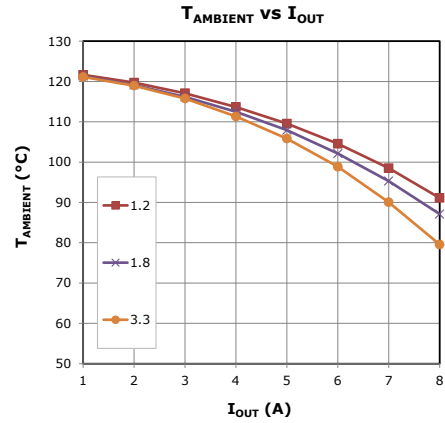

Figure 30: XR76108 Package Thermal Derating, 5VIN

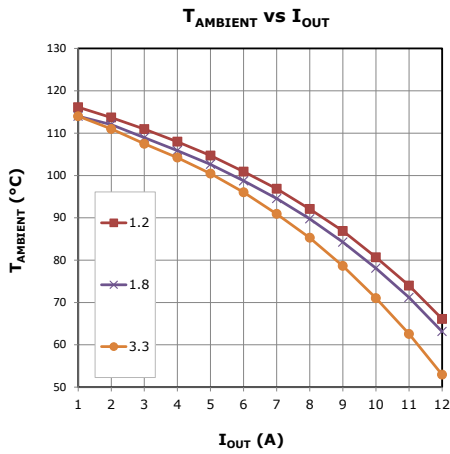

Figure 31: XR76112 Package Thermal Derating, 12VIN

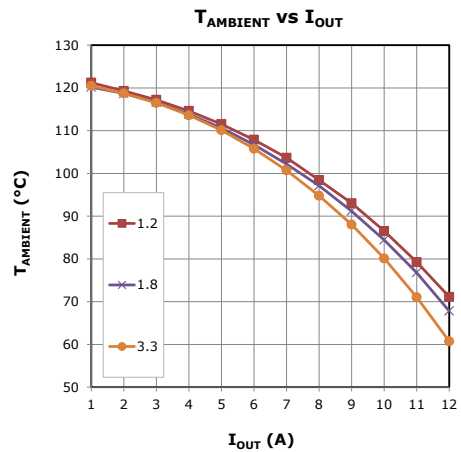

Figure 32: XR76112 Package Thermal Derating, 5VIN

Detailed Operation

The XR76108 / XR76112 uses a synchronous step-down proprietary emulated current-mode Constant On-Time (COT) control scheme. The on-time, which is programmed via R_{ON} , is inversely proportional to V_{IN} and maintains a nearly constant frequency. The emulated current-mode control allows the use of ceramic output capacitors.

Each switching cycle begins with the high-side (switching) FET turning on for a pre-programmed time. At the end of the on-time, the high-side FET is turned off and the low-side (synchronous) FET is turned on for a preset minimum time (250ns nominal). This parameter is termed the Minimum Off-Time. After the Minimum Off-Time, the voltage at the feedback pin FB is compared to an internal voltage ramp at the feedback comparator. When V_{FB} drops below the ramp voltage, the high-side FET is turned on and the cycle repeats. This voltage ramp constitutes an emulated current ramp and allows for the use of ceramic capacitors, in addition to other capacitor types, for output filtering.

Enable / Mode

The EN / MODE pin accepts a tri-level signal that is used to control turn-on and turn-off. It also selects between two modes of operation: 'Forced CCM' and 'DCM / CCM'. If EN is pulled below 1.8V, the regulator shuts down. A voltage between 2.0V and 2.8V selects the Forced CCM mode, which will run the converter in continuous conduction for all load currents. A voltage higher than 3.1V selects the DCM / CCM mode, which will run the converter in discontinuous conduction mode at light loads.

Selecting the Forced CCM Mode

In order to set the controller to operate in Forced CCM, a voltage between 2.0V and 2.8V must be applied to EN / MODE. This can be achieved with an external control signal that meets the above voltage requirement. The EN / MODE can be derived from V_{IN} where an external control is not available. If V_{IN} is well regulated, use a resistor divider and set the voltage to 2.45V. If V_{IN} varies over a wide range, the circuit shown in Figure 33 can be used to generate the required voltage.

Selecting the DCM / CCM Mode

In order to set the controller operation to DCM / CCM, a voltage between 3.1V and 5.5V must be applied to the EN / MODE pin and be sequenced with respect to V_{OUT} , such that $2.0 \leq V_{EN} \leq 2.8V$ when V_{OUT} finishes soft-start.

If an external 5V control signal is available, use a low-pass RC and set the time constant to $RC = 5.5 \times t_{ss}$, where t_{ss} is the soft-start time. R should be in the 50kΩ - 100kΩ range. Time t_1 can be approximated from $t_1 = 2.8 \times t_{ss}$. The timing circuit and diagram are shown in Figure 34.

If an external 3.3V control signal is available, use a low-pass RC and set the time constant to $RC = 2.1 \times t_{ss}$. R should be in the 50kΩ - 100kΩ range. Time t_1 can be approximated from $t_1 = 1.9 \times t_{ss}$ (Figure 34).

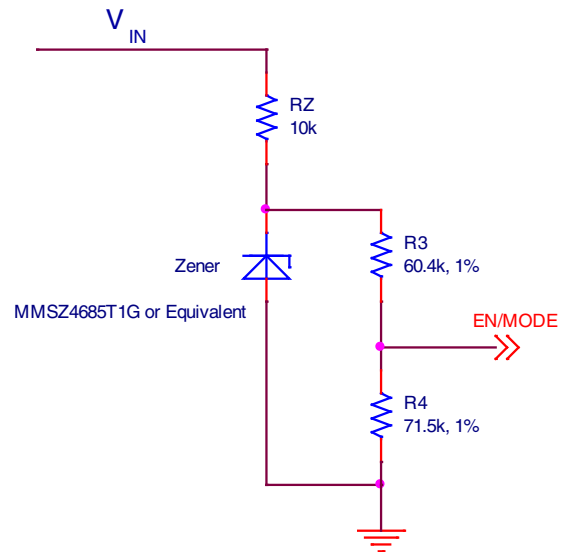

Figure 33: Selecting Forced CCM by Deriving EN/MODE from V_{IN}

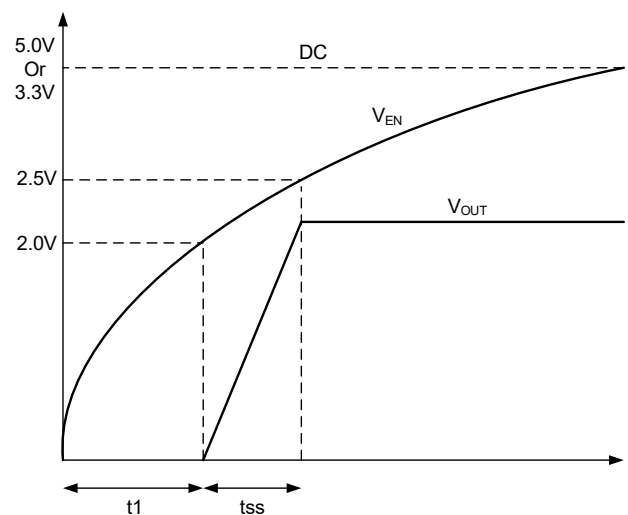
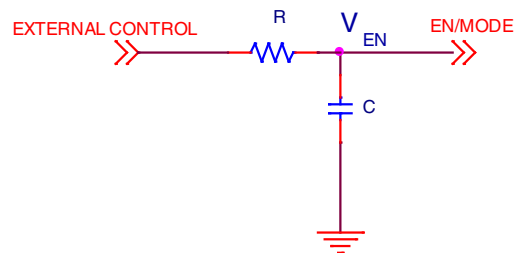

Figure 34: Timing Circuit and Diagram for Selecting DCM / CCM by Using an External Enable Signal

EN / MODE input must be derived from V_{IN} in applications where an external control is not available. The timing circuit and diagram are shown in Figure 35. Calculate the time constant from $RC = 4.7 \times t_{ss}$. The value of R3 should be between 50kΩ - 100kΩ. t_1 can be approximated from $t_1 = 2.7 \times t_{ss}$. The R3 and C in Figure 35 correspond to 2.8ms typical soft-start of the application circuit.

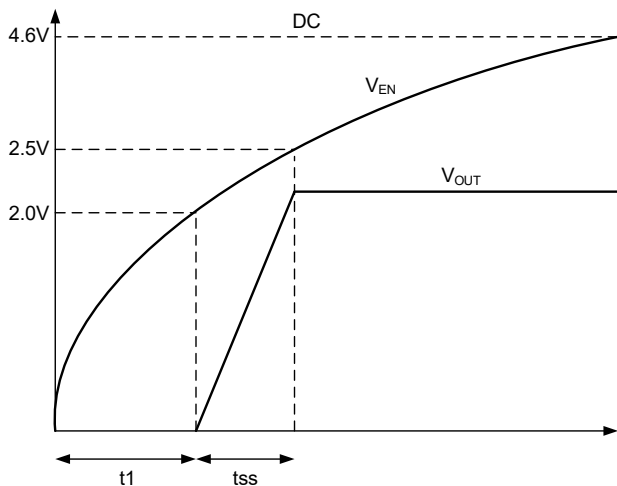
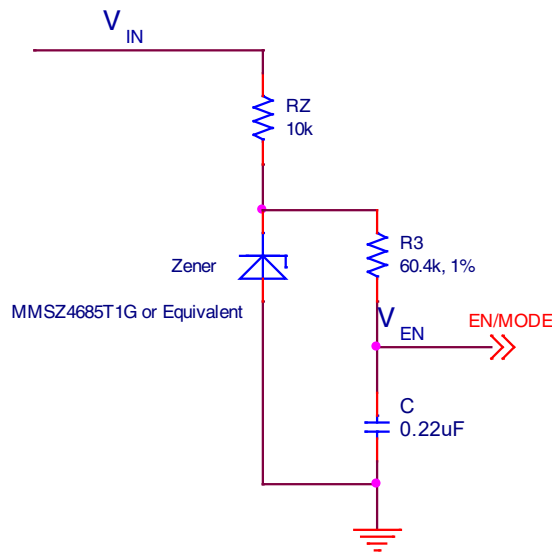

Figure 35: Timing Circuit and Diagram for Selecting DCM / CCM by deriving EN / MODE from V_{IN}

Programming the On-Time

The on-time T_{ON} is programmed via resistor R_{ON} according to following equation:

$$R_{ON} = \frac{V_{IN} \times [T_{ON} - (3 \times 10^{-8})]}{2.9 \times 10^{-10}}$$

where T_{ON} is calculated from:

$$T_{ON} = \frac{V_{OUT}}{V_{IN} \times f \times Eff.}$$

where:

f is the desired switching frequency at nominal I_{OUT}

Eff. is the converter efficiency corresponding to nominal I_{OUT}

Substituting for T_{ON} in the first equation we get:

$$R_{ON} = \frac{\left(\frac{V_{OUT}}{f \times Eff.}\right) - [(3 \times 10^{-8}) \times V_{IN}]}{(2.9 \times 10^{-10})}$$

At $V_{IN} = 12V$, $f = 600kHz$, $I_{OUT} = 8A$ and using the efficiency numbers from Figure 25, we get the following R_{ON} for XR76108:

V_{OUT} (V)	R_{ON} (kΩ)
5.0	29.3
3.3	19.4
2.5	14.5
1.8	10.4
1.5	8.67
1.2	6.87
1.0	5.68

Figure 36: XR76108 R_{ON} for Common Output Voltages, $V_{IN} = 12V$, $I_{OUT} = 8A$, $f = 600kHz$

Over-Current Protection (OCP)

If the load current exceeds the programmed over-current I_{OCP} for four consecutive switching cycles, then the regulator enters the hiccup mode of operation. In hiccup mode, the MOSFET gates are turned off for 110ms (hiccup timeout). Following the hiccup timeout, a soft-start is attempted. If OCP persists, hiccup timeout will repeat. The regulator will remain in hiccup mode until load current is reduced below the programmed I_{OCP} . In order to program over-current protection, use the following equation:

$$R_{LIM} = \frac{(I_{OCP} \times R_{DS(on)}) + 8mV}{I_{LIM}}$$

where:

R_{LIM} is resistor value for programming I_{OCP}

I_{OCP} is the over-current value to be programmed

$R_{DS(on)} = 10m\Omega$ (XR76108)

$R_{DS(on)} = 9m\Omega$ (XR76112)

8mV is the OCP comparator offset

I_{LIM} is the internal current that generates the necessary OCP comparator threshold (45 μ A)

Note that I_{LIM} has a positive temperature coefficient of 0.4%/°C. This is meant to approximately match and compensate for the positive temperature coefficient of the synchronous FET's $R_{DS(ON)}$.

The above equation is for worst-case analysis and safeguards against premature OCP. Actual value of I_{OCP} , for a given R_{LIM} , will be higher than that predicted by the above equation. Typical I_{OCP} versus R_{LIM} is shown in Figure 22.

Short-Circuit Protection (SCP)

If the output voltage drops below 60% of its programmed value, the regulator will enter hiccup mode. Hiccup mode will persist until the short-circuit is removed. The SCP circuit becomes active after PGOOD asserts high.

Over-Temperature Protection (OTP)

OTP triggers at a nominal controller temperature of 150°C. The gates of the switching FET and the synchronous FET are turned off. When controller temperature cools down to 135°C, soft-start is initiated and operation resumes.

Programming the Output Voltage

Use an external voltage divider as shown in Figure 1 to program the output voltage V_{OUT} .

$$R1 = R2 \times \left(\frac{V_{OUT}}{0.6} - 1 \right)$$

The recommended value for R2 is 2k Ω .

Programming the Soft-Start

Place a capacitor C_{SS} between the SS and GND pins to program the soft-start. In order to program a soft-start time of T_{SS} , calculate the required capacitance C_{SS} from the following equation:

$$C_{SS} = T_{SS} \times \frac{10\mu A}{0.6V}$$

Feed-Forward Capacitor C_{FF}

The voltage divider R1-R2 attenuates the output voltage ripple ($V_{OUT,RIPPLE}$) that is fed back to the controller's FB pin. The steady-state voltage ripple at FB ($V_{FB,RIPPLE}$) must not exceed 50mV in order for the controller to function correctly. If $V_{FB,RIPPLE}$ is larger than 50mV, a C_{FF} should not be used. C_{OUT} should be increased as necessary in order to keep the $V_{FB,RIPPLE}$ below 50mV.

It is recommended to use a feed-forward capacitor (C_{FF}) if output voltage ripple ($V_{OUT,RIPPLE}$) is less than 50mV. C_{FF} provides a low-impedance / high-frequency path for the $V_{OUT,RIPPLE}$ to be transmitted to FB. It also helps achieve an optimum transient load response. Calculate C_{FF} from:

$$C_{FF} = \frac{1}{2 \times \pi \times f \times 0.1 \times R1}$$

A load step test should be performed and if necessary C_{FF} can be adjusted in order to get a critically damped transient load response.

Feed-Forward Resistor R_{FF}

Fast turn on and turn off of power FETs gives rise to switching noise that may be coupled to the feedback pin. Excessive switching noise at FB will result in poor load regulation. A resistor R_{FF} , in series with C_{FF} , helps decouple noise and restore good load regulation. Maximum value of R_{FF} should not exceed $0.02 \times R1$.

Thermal Design

Proper thermal design is critical in controlling device temperatures and in achieving robust designs. There are a number of factors that affect the thermal performance. One key factor is the temperature rise of the devices in the package, which is a function of the thermal resistances of the devices inside the package and the power being dissipated.

The thermal resistances of the XR76108 / XR76112 are specified in the "Operating Ratings" section of this datasheet. The JEDEC θ_{JA} thermal resistance provided is based on tests that comply with the JESD51-2A "Integrated Circuit Thermal Test Method Environmental Conditions - Natural Convection" standard. JESD51-xx are a group of standards whose intent is to provide comparative data based on a standard test condition which includes a defined board construction. Since the actual board design in the final application will be different from the board defined in the standard, the thermal resistances in the final design may be different from those shown.

The package thermal derating curves for the XR76108 are shown in Figures 29 and 30. These correspond to input voltages of 12V and 5V respectively. The package thermal derating curves for the XR76112 are shown in Figures 31 and 32.

Operation at $V_{IN} < 6V$

As V_{IN} falls below approximately 5V, the V_{CC} regulator will start to operate in dropout. This means it is no longer regulating the output of V_{CC} . V_{CC} is designed with a UVLO function to ensure all internal circuitry has sufficient voltage to operate to meet datasheet specifications and properly drive the internal MOSFETs. The UVLO is set to allow the chip to start operating once V_{CC} reaches 4.25V and will disable the chip if the voltage falls below 4.00V.

When V_{IN} is 4.5V and the part is not switching, the output of the V_{CC} regulator will be close to V_{IN} and be high enough to ensure it is above the V_{CC} UVLO. Although once switching starts, the output of V_{CC} may fall as low as 4.3V, the UVLO shutdown threshold is guaranteed to be less than 4.25V.

Mechanical Dimensions

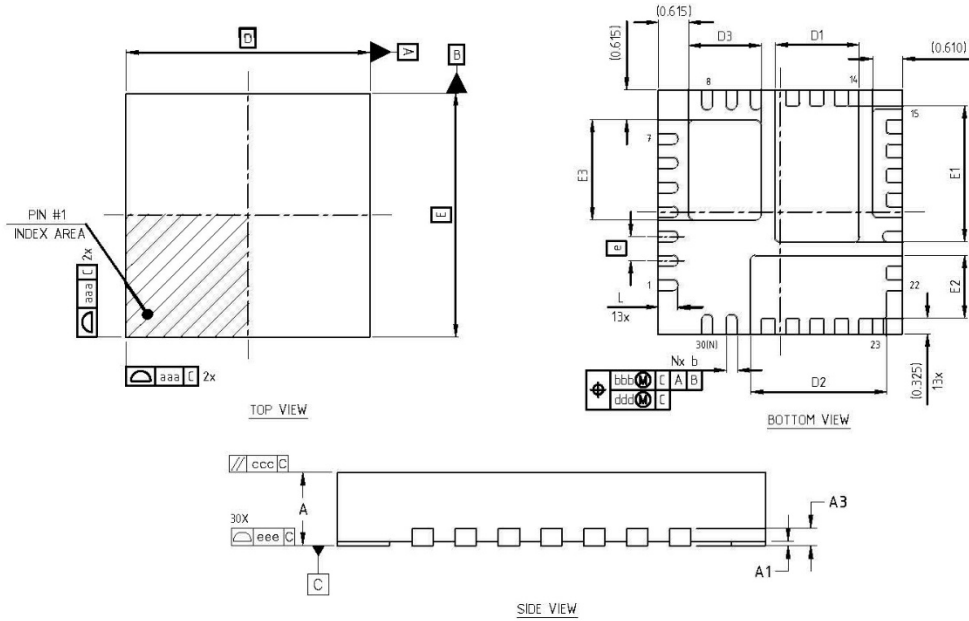

Dimension Table			
Thickness Symbol	MINIMUM	NOMINAL	MAXIMUM
A	0.80	0.90	1.00
A1	0.00	0.02	0.05
A3	0.20 Ref.		
b	0.18	0.25	0.30
D	5.00 BSC		
E	5.00 BSC		
e	0.50 BSC		
D1	1.570	1.720	1.820
E1	2.635	2.785	2.885
D2	2.635	2.785	2.885
E2	1.135	1.285	1.385
D3	1.345	1.495	1.595
E3	1.903	2.053	2.153
L	0.30	0.40	0.50
aaa	0.05		
bbb	0.10		
ccc	0.10		
ddd	0.05		
eee	0.08		
N	30		

TERMINAL DETAIL

NOTE : ALL DIMENSIONS ARE IN MILLIMETERS, ANGLES ARE IN DEGREES.

Drawing No.: POD-00000018

Revision: B

Recommended Land Pattern and Stencil

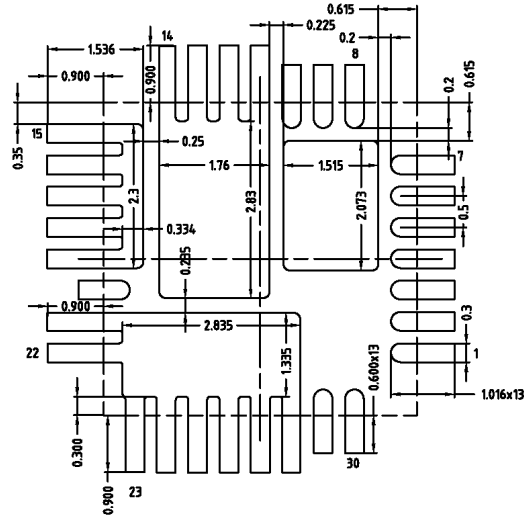

TYPICAL RECOMMENDED LAND PATTERN

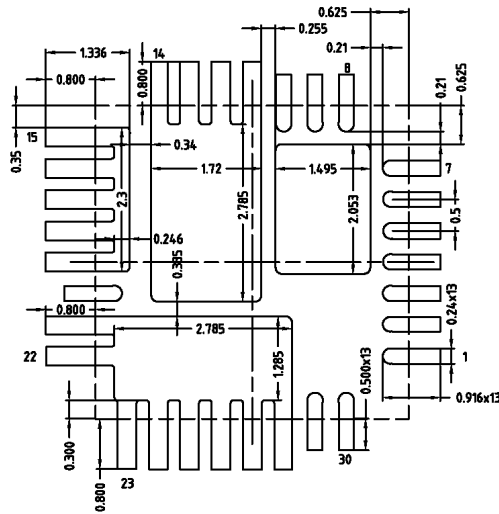

TYPICAL RECOMMENDED STENCIL

NOTE : ALL DIMENSIONS ARE IN MILLIMETERS, ANGLES ARE IN DEGREES.

Drawing No.: POD-00000018

Revision: B

Revision History

Revision	Date	Description
1A	March 2014	Initial release: ECN 1413-13 03-26-14
2A	August 2014	Changed figure 1, 3, 17-20, 33-38. Extend input operating range down to 4.5V. Changed V_{CC} dropout conditions. Changed V_{CC} UVLO specification. Added applications information for operating $V_{IN}<6V$. Added ESD CDM Rating. Added to SW and BST pin definition. Removed Diode emulation write up. Added selecting the CCM mode and selecting the DCM/CCM mode applications information. Changed CFF and RFF write up and equations. Changed programming the TON write up and equations. On page 1 in the general description and Features section changed minimum VIN range from 5.0V to 4.5V.
2B	June 2018	Updated to MaxLinear logo. Updated format and Ordering Information table.
2C	10/18/19	Correct block diagram by changing the input gate to the Hiccup Mode block from an AND gate to an OR gate. Update ordering information.

**Corporate Headquarters:**

5966 La Place Court
 Suite 100
 Carlsbad, CA 92008
 Tel.: +1 (760) 692-0711
 Fax: +1 (760) 444-8598
www.maxlinear.com

The content of this document is furnished for informational use only, is subject to change without notice, and should not be construed as a commitment by MaxLinear, Inc. MaxLinear, Inc. assumes no responsibility or liability for any errors or inaccuracies that may appear in the informational content contained in this guide. Complying with all applicable copyright laws is the responsibility of the user. Without limiting the rights under copyright, no part of this document may be reproduced into, stored in, or introduced into a retrieval system, or transmitted in any form or by any means (electronic, mechanical, photocopying, recording, or otherwise), or for any purpose, without the express written permission of MaxLinear, Inc.

MaxLinear, Inc. does not recommend the use of any of its products in life support applications where the failure or malfunction of the product can reasonably be expected to cause failure of the life support system or to significantly affect its safety or effectiveness. Products are not authorized for use in such applications unless MaxLinear, Inc. receives, in writing, assurances to its satisfaction that: (a) the risk of injury or damage has been minimized; (b) the user assumes all such risks; (c) potential liability of MaxLinear, Inc. is adequately protected under the circumstances.

MaxLinear, Inc. may have patents, patent applications, trademarks, copyrights, or other intellectual property rights covering subject matter in this document. Except as expressly provided in any written license agreement from MaxLinear, Inc., the furnishing of this document does not give you any license to these patents, trademarks, copyrights, or other intellectual property.

MaxLinear, the MaxLinear logo, and any MaxLinear trademarks, MxL, Full-Spectrum Capture, FSC, G.now, AirPHY and the MaxLinear logo are all on the products sold, are all trademarks of MaxLinear, Inc. or one of MaxLinear's subsidiaries in the U.S.A. and other countries. All rights reserved. Other company trademarks and product names appearing herein are the property of their respective owners.

© 2013 - 2019 MaxLinear, Inc. All rights reserved

X-ON Electronics

Largest Supplier of Electrical and Electronic Components

Click to view similar products for [Switching Voltage Regulators](#) category:

Click to view products by [MaxLinear](#) manufacturer:

Other Similar products are found below :

[FAN53610AUC33X](#) [FAN53611AUC123X](#) [MP2374DS-LF-Z](#) [EN6310QA](#) [NCP81108MNTXG](#) [NCP81109BMNTXG](#) [FAN48610BUC45X](#)
[FAN48617UC50X](#) [R3](#) [KE177614](#) [EP5358LUA](#) [MPQ4423GQ-AEC1-Z](#) [FAN53611AUC12X](#) [MAX809TTR](#) [NCV891234MW50R2G](#)
[AST1S31PUR](#) [NCP81103MNTXG](#) [NCP81203PMNTXG](#) [NCP81208MNTXG](#) [NCP81109GMNTXG](#) [SCY1751FCCT1G](#)
[NCP81109JMNTXG](#) [MP2161AGJ-Z](#) [NCP81241MNTXG](#) [MP2388GQEU-Z](#) [MPQ4481GU-AEC1-P](#) [MP8756GD-P](#) [MPQ2171GJ-P](#)
[MPQ2171GJ-AEC1-P](#) [MP2171GJ-P](#) [NCV1077CSTBT3G](#) [MP28160GC-Z](#) [MPM3509GQVE-AEC1-P](#) [LTM4691EV#PBF](#) [XCL207A123CR-](#)
[G](#) [XDPE132G5CG000XUMA1](#) [XDPE12284C0000XUMA1](#) [LTM4691IV#PBF](#) [MP5461GC-P](#) [MP28301GG-P](#) [MIC23356YFT-TR](#)
[ISL95338IRTZ](#) [MP3416GJ-P](#) [BD9S201NUX-CE2](#) [ISL9113AIRAZ-T](#) [MP5461GC-Z](#) [MPQ2172GJ-AEC1-Z](#) [MPQ4415AGQB-Z](#)
[MPQ4590GS-Z](#) [IR3888AMTRPBFAUMA1](#)