

## ● FEATURES 特性

1.表面贴装,小型、超薄电感器,大功率,高饱和,低电阻之特性. he inductor designed as surface mounting , smallest and thinnest with high power , high saturation and low resistance

2.磁性胶水涂敷结构极大减少了噪声, 闭合磁路结构设计,漏磁少,抗 EMI 能力强.

Magnetic-resin shielded structure reduces buzz noise to ultra-low levels , Closed magnetic circuit structure reduces magnetic leakage flux , high performance of anti-EMI . 3.同等尺寸额定电流较传统电感高出 30%以上.

Compared with the same size part , the rated current 30% higher than the traditional inductors . 4.工作频率范围广,可达 5MHz 以上. Wide range working frequency that reach more than 5MHz 5.RoHS , 无卤环保产品. RoHS ,Halogen-free environmental protection products

## ● APPLICATIONS 用途

1. LED Lighting LED 照明

2. Automotive systems 汽车产品

3. Notebooks,desktop computers,servers,graphic cards 笔记本电脑, 台式电脑, 服务器, 显卡

## ● PART NUMBERING SYSTEM 品名系统

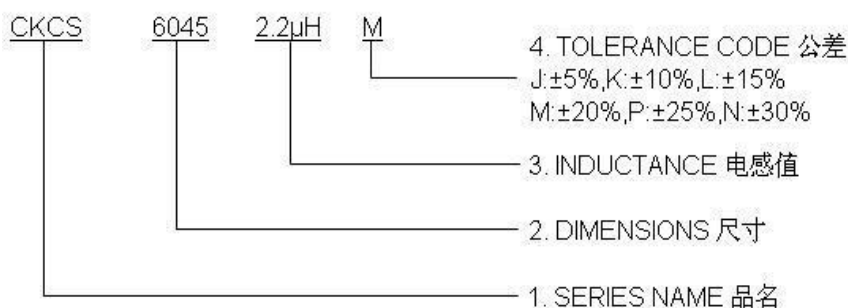

## ● STRUCTURAL DRAWING 结构图

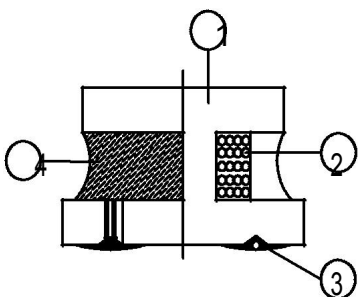

- |                |                           |
|----------------|---------------------------|
| ① Ferrite core | Ni-Zn Ferrite             |
| ② Winding wire | Polyurethane-copper wire  |
| ③ Electrode    | External electrode        |
| ④ Epoxy resin  | containing ferrite powder |

● SHAPES AND DIMENSIONS 外形尺寸 (Unit:mm)

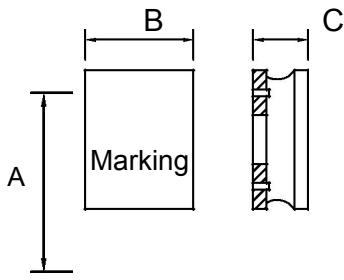

Fig 1

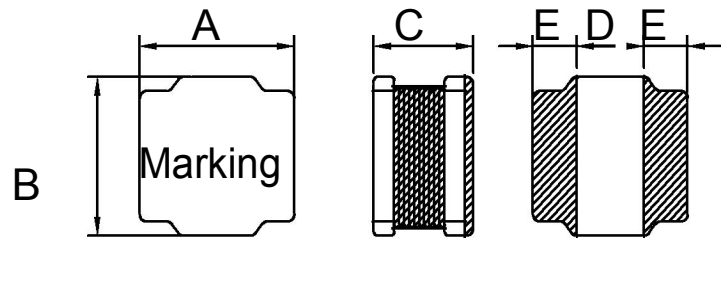

Fig 2

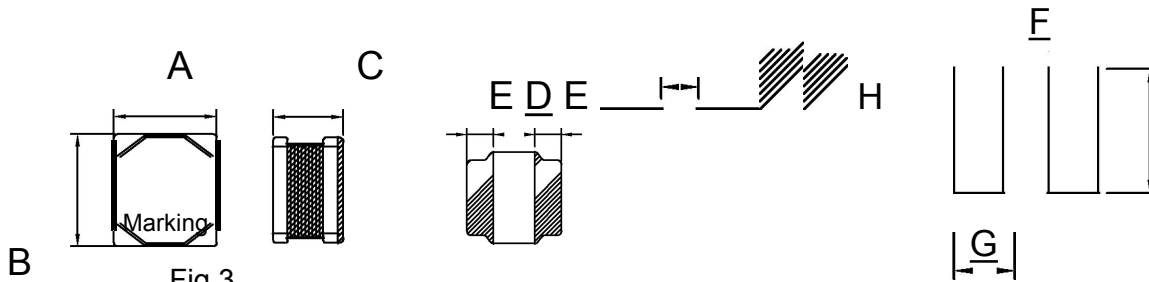

Fig 3

Recommended patterns

TYPE(型号)	A	B	C	D	E	F	G	H	Fig
XRNR201610	2.0±0.3	1.6±0.3	1.05 Max	0.6±0.2	0.77±0.2	0.6	0.8	1.8	1
XRNR252010	2.5±0.3	2.0±0.3	1.05 Max	0.8±0.3	0.9±0.3	0.6	1.1	2.0	1
XRNR252012	2.5±0.3	2.0±0.3	1.25 Max	0.8±0.3	0.9±0.3	0.6	1.1	2.0	1
XRNRS3010	3.0±0.2	3.0±0.2	1.1 Max	1.2±0.3	0.9±0.3	1.1	1.0	2.7	3
XRNRS3012	3.0±0.2	3.0±0.2	1.3 Max	1.2±0.3	0.9±0.3	1.1	1.0	2.7	3
XRNRS3015	3.0±0.2	3.0±0.2	1.7 Max	1.2±0.3	0.9±0.3	1.1	1.0	2.7	3
XRNR4012	4.0±0.2	4.0±0.2	1.2 Max	1.6±0.3	1.2±0.3	1.4	1.3	3.7	3
XRNR4018	4.0±0.2	4.0±0.2	1.8 Max	1.6±0.3	1.2±0.3	1.4	1.3	3.7	3
XRNR4020	4.0±0.2	4.0±0.2	2.0 Max	1.6±0.3	1.2±0.3	1.4	1.3	3.7	3
XRNR4030	4.0±0.2	4.0±0.2	3.0 Max	1.3±0.3	1.35±0.3	1.2	1.40	3.7	3
XRNR5020	5.0±0.2	5.0±0.2	2.1 Max	1.4±0.3	1.8±0.3	1.2	1.9	4.2	2
XRNR5040	5.0±0.2	5.0±0.2	4.0 Max	1.6±0.3	1.7±0.3	1.4	1.8	4.2	3
XRNR6020	6.0±0.3	6.0±0.3	2.1 Max	2.3±0.3	1.85±0.3	2.4	1.8	5.7	2
XRNRS6028	6.0±0.3	6.0±0.3	3.0 Max	2.3±0.3	1.85±0.3	2.4	1.8	5.7	2
XRNR6045	6.0±0.3	6.0±0.3	4.7 Max	2.3±0.3	1.85±0.3	2.4	1.8	5.7	2
XRNR8040	8.0±0.3	8.0±0.3	4.2 Max	3.8±0.3	2.1±0.3	3.6	2.2	7.5	2

● SPECIFICATION TABLE:

PART NUMBER 品名	INDUCTANCE ( $\mu$ H) 电感值	DCR (Max.) ( $\Omega$ ) 直流电阻	Isat (Max.) (A) 饱和电流	Irms (Max.) (A) 额定电流	Marker 印字
XRNR201610-0.47uH/N	0.47 $\pm$ 30%	0.059	2.30	2.35	/
XRNR201610-0.68uH/N	0.68 $\pm$ 30%	0.076	1.95	2.05	/
XRNR201610-1uH/N	1.0 $\pm$ 30%	0.114	1.65	1.45	/
XRNR201610-1.5uH/N	1.5 $\pm$ 30%	0.174	1.35	1.25	/
XRNR201610-2.2uH/M	2.2 $\pm$ 20%	0.264	1.20	1.10	/
XRNR201610-3.3uH/M	3.3 $\pm$ 20%	0.335	0.90	0.88	/
XRNR201610-4.7uH/M	4.7 $\pm$ 20%	0.479	0.70	0.74	/
XRNR201610-6.8uH/M	6.8 $\pm$ 20%	0.816	0.60	0.52	/
XRNR201610-10uH/M	10 $\pm$ 20%	1.020	0.50	0.45	/

PART NUMBER 品名	INDUCTANCE ( $\mu$ H) 电感值	DCR (Max.) ( $\Omega$ ) 直流电阻	Isat (Max.) (A) 饱和电流	Irms (Max.) (A) 额定电流	Marker 印字
XRNR252010-1.0uH/N	1.0 $\pm$ 30%	0.108	1.85	1.65	A
XRNR252010-1.5uH/N	1.5 $\pm$ 30%	0.182	1.80	1.30	B
XRNR252010-2.2uH/N	2.2 $\pm$ 30%	0.209	1.20	1.20	C
XRNR252010-3.3uH/M	3.3 $\pm$ 20%	0.328	1.05	0.90	D
XRNR252010-4.7uH/N	4.7 $\pm$ 20%	0.563	0.95	0.70	E
XRNR252010-5.6uH/M	5.6 $\pm$ 20%	0.563	0.80	0.73	F
XRNR252010-6.8uH/M	6.8 $\pm$ 20%	0.896	0.78	0.59	G
XRNR252010-10uH/M	10 $\pm$ 20%	1.092	0.65	0.50	H
XRNR252010-15uH/M	15 $\pm$ 20%	1.885	0.46	0.36	I
XRNR252010-22uH/M	22 $\pm$ 20%	2.400	0.45	0.30	J

Remark: 1. Inductance Tested at 1MHz, 0.25Vrms (20°C)

2. Isat: DC current at which the inductance drops approximate 30% from its value without current;
3. Irms: DC current that causes the temperature rise ( $\Delta T = 40^\circ\text{C}$ ) from 25°C ambient.
4. Operating Temperature : -25°C ~ +125°C

● SPECIFICATION TABLE:

PART NUMBER 品名	INDUCTANCE ( $\mu$ H) 电感值	DCR (Max.) ( $\Omega$ ) 直流电阻	Isat (Max.) (A) 饱和电流	Irms (Max.) (A) 额定电流	Marker 印字
XRNR252012-0.47uH/N	0.47 $\pm$ 30%	0.061	3.82	2.15	A
XRNR252012-0.68uH/N	0.68 $\pm$ 30%	0.074	3.28	1.95	B
XRNR252012-1.0uH/N	1.0 $\pm$ 30%	0.09	2.59	1.93	C
XRNR252012-1.2uH/N	1.2 $\pm$ 30%	0.129	2.38	1.46	D
XRNR252012-1.5uH/N	1.5 $\pm$ 30%	0.147	2.24	1.40	E
XRNR252012-2.2uH/N	2.2 $\pm$ 30%	0.216	1.85	1.15	F
XRNR252012-3.3uH/M	3.3 $\pm$ 20%	0.264	1.61	1.04	G
XRNR252012-4.7uH/M	4.7 $\pm$ 20%	0.377	1.12	0.84	H
XRNR252012-5.6uH/M	5.6 $\pm$ 20%	0.538	1.11	0.73	I
XRNR252012-6.8uH/M	6.8 $\pm$ 20%	0.581	0.98	0.69	J
XRNR252012-8.2uH/M	8.2 $\pm$ 20%	0.658	0.98	0.65	N
XRNR252012-10uH/M	10 $\pm$ 20%	0.69	0.79	0.62	K
XRNR252012-12uH/M	12 $\pm$ 20%	1.075	0.78	0.51	O
XRNR252012-15uH/M	15 $\pm$ 20%	1.591	0.68	0.42	L
XRNR252012-22uH/M	22 $\pm$ 20%	1.976	0.53	0.38	M

Remark: 1. Inductance Tested at 1MHz, 0.25Vrms (20 $^{\circ}$ C)

2. Isat: DC current at which the inductance drops approximate 30% from its value without current;
3. Irms: DC current that causes the temperature rise ( $\Delta T = 40^{\circ}C$ ) from 25 $^{\circ}$ C ambient.
4. Operating Temperature : -25 $^{\circ}$ C ~ +125 $^{\circ}$ C

● SPECIFICATION TABLE:

PART NUMBER 品名	INDUCTANCE ( $\mu$ H) 电感值	DCR ( $\pm$ 30%) ( $\Omega$ ) 直流电阻	Isat (Max.) (A) 饱和电流	Irms (Max.) (A) 额定电流	S.R.F.(Min.) (MHz) 自谐频率
XRNR3010-1.0uH/N	1.0 $\pm$ 30%	0.065	1.40	1.45	180
XRNR3010-1.5uH/N	1.5 $\pm$ 30%	0.080	1.27	1.30	120
XRNR3010-2.2uH/N	2.2 $\pm$ 30%	0.110	1.15	1.09	100
XRNR3010-3.3uH/M	3.3 $\pm$ 20%	0.145	0.97	0.96	74
XRNR3010-4.7uH/M	4.7 $\pm$ 20%	0.225	0.75	0.77	59
XRNR3010-6.8uH/M	6.8 $\pm$ 20%	0.305	0.55	0.66	42
XRNR3010-10uH/M	10 $\pm$ 20%	0.400	0.55	0.58	39
XRNR3010-15uH/M	15 $\pm$ 20%	0.610	0.42	0.47	30
XRNR3010-22uH/M	22 $\pm$ 20%	0.930	0.35	0.38	28
XRNR3010-33uH/M	33 $\pm$ 20%	1.550	0.29	0.30	18
XRNR3010-47uH/M	47 $\pm$ 20%	1.950	0.22	0.26	18

PART NUMBER 品名	INDUCTANCE ( $\mu$ H) 电感值	DCR ( $\pm$ 30%) ( $\Omega$ ) 直流电阻	Isat (Max.) (A) 饱和电流	Irms (Max.) (A) 额定电流	S.R.F.(Min.) (MHz) 自谐频率
XRNR3012-1.0uH/N	1.0 $\pm$ 30%	0.040	1.87	2.20	120
XRNR3012-1.5uH/N	1.5 $\pm$ 30%	0.045	1.62	2.01	110
XRNR3012-2.2uH/N	2.2 $\pm$ 30%	0.075	1.20	1.55	84
XRNR3012-3.3uH/M	3.3 $\pm$ 20%	0.100	1.05	1.36	64
XRNR3012-4.7uH/M	4.7 $\pm$ 20%	0.120	0.90	1.24	61
XRNR3012-6.8uH/M	6.8 $\pm$ 20%	0.190	0.75	0.98	61
XRNR3012-10uH/M	10 $\pm$ 20%	0.265	0.60	0.83	42
XRNR3012-15uH/M	15 $\pm$ 20%	0.360	0.45	0.71	27
XRNR3012-22uH/M	22 $\pm$ 20%	0.645	0.42	0.53	23
XRNR3012-33uH/M	33 $\pm$ 20%	0.875	0.36	0.46	18
XRNR3012-47uH/M	47 $\pm$ 20%	1.450	0.27	0.35	14
XRNR3012-68uH/M	68 $\pm$ 20%	1.670	0.24	0.33	12

Remark: 1. Inductance Tested at 100kHz, 1Vrms (20 $^{\circ}$ C)

2. Isat: DC current at which the inductance drops approximate 30% from its value without current;
3. Irms: DC current that causes the temperature rise ( $\Delta$ T =40 $^{\circ}$ C ) from 25 $^{\circ}$ C ambient.
4. Operating Temperature : -25 $^{\circ}$ C ~ +125 $^{\circ}$ C

● SPECIFICATION TABLE:

PART NUMBER 品名	INDUCTANCE ( $\mu$ H) 电感值	DCR ( $\pm$ 30%) ( $\Omega$ ) 直流电阻	Isat (Max.) (A) 饱和电流	Irms (Max.) (A) 额定电流	S.R.F.(Min.) (MHz) 自谐频率
XRNR3015-1.0uH/N	1.0 $\pm$ 30%	0.039	2.32	2.35	150
XRNR3015-1.2uH/N	1.2 $\pm$ 30%	0.040	2.21	1.95	110
XRNR3015-1.5uH/N	1.5 $\pm$ 30%	0.050	2.00	1.70	100
XRNR3015-1.8uH/N	1.8 $\pm$ 30%	0.050	1.75	1.70	92
XRNR3015-2.2uH/N	2.2 $\pm$ 30%	0.060	1.60	1.60	86
XRNR3015-3.3uH/M	3.3 $\pm$ 20%	0.080	1.32	1.36	68
XRNR3015-4.7uH/M	4.7 $\pm$ 20%	0.125	1.10	1.09	46
XRNR3015-6.8uH/M	6.8 $\pm$ 20%	0.200	0.85	0.85	39
XRNR3015-10uH/M	10 $\pm$ 20%	0.250	0.72	0.77	41
XRNR3015-12uH/M	12 $\pm$ 20%	0.320	0.70	0.68	32
XRNR3015-15uH/M	15 $\pm$ 20%	0.350	0.66	0.65	30
XRNR3015-18uH/M	18 $\pm$ 20%	0.430	0.56	0.59	23
XRNR3015-22uH/M	22 $\pm$ 20%	0.460	0.52	0.57	23
XRNR3015-33uH/M	33 $\pm$ 20%	0.820	0.44	0.43	20
XRNR3015-47uH/M	47 $\pm$ 20%	1.250	0.35	0.35	14

Remark: 1. Inductance Tested at 100kHz, 1Vrms (20 $^{\circ}$ C)

2. Isat: DC current at which the inductance drops approximate 30% from its value without current;
3. Irms: DC current that causes the temperature rise ( $\Delta$ T =40 $^{\circ}$ C ) from 25 $^{\circ}$ C ambient.
4. Operating Temperature : -25 $^{\circ}$ C ~ +125 $^{\circ}$ C

● SPECIFICATION TABLE:

PART NUMBER 品名	INDUCTANCE ( $\mu$ H) 电感值	DCR ( $\pm$ 30%) ( $\Omega$ ) 直流电阻	Isat (Max.) (A) 饱和电流	Irms (Max.) (A) 额定电流	S.R.F.(Min.) (MHz) 自谐频率
XRNR4012-0.82uH/N	0.82 $\pm$ 30%	0.050	3.02	1.65	150
XRNR4012-1.0uH/N	1.0 $\pm$ 30%	0.050	2.61	1.65	120
XRNR4012-1.5uH/N	1.5 $\pm$ 30%	0.065	2.10	1.46	90
XRNR4012-1.8uH/N	1.8 $\pm$ 30%	0.080	2.12	1.32	88
XRNR4012-2.2uH/N	2.2 $\pm$ 30%	0.080	1.76	1.32	74
XRNR4012-3.3uH/N	3.3 $\pm$ 30%	0.110	1.72	1.12	60
XRNR4012-4.7uH/N	4.7 $\pm$ 30%	0.125	1.15	1.05	50
XRNR4012-6.8uH/M	6.8 $\pm$ 20%	0.198	0.85	0.84	40
XRNR4012-10uH/M	10 $\pm$ 20%	0.265	0.80	0.77	33
XRNR4012-12uH/M	12 $\pm$ 20%	0.290	0.66	0.70	32
XRNR4012-15uH/M	15 $\pm$ 20%	0.340	0.56	0.64	25
XRNR4012-22uH/M	22 $\pm$ 20%	0.587	0.46	0.49	20
XRNR4012-33uH/M	33 $\pm$ 20%	0.810	0.42	0.42	17
XRNR4012-47uH/M	47 $\pm$ 20%	1.100	0.35	0.37	12
XRNR4012-68uH/M	68 $\pm$ 20%	1.950	0.38	0.27	11
XRNR4012-82uH/M	82 $\pm$ 20%	2.140	0.28	0.26	11
XRNR4012-100uH/M	100 $\pm$ 20%	2.210	0.25	0.25	9.4

Remark: 1. Inductance Tested at 100kHz, 1Vrms (20 $^{\circ}$ C)

2. Isat: DC current at which the inductance drops approximate 30% from its value without current;
3. Irms: DC current that causes the temperature rise ( $\Delta T = 40^{\circ}C$ ) from 25 $^{\circ}$ C ambient.
4. Operating Temperature : -25 $^{\circ}$ C ~ +125 $^{\circ}$ C

● SPECIFICATION TABLE:

PART NUMBER 品名	INDUCTANCE ( $\mu$ H) 电感值	DCR ( $\pm$ 30%) ( $\Omega$ ) 直流电阻	Isat (Max.) (A) 饱和电流	Irms (Max.) (A) 额定电流	S.R.F.(Min.) (MHz) 自谐频率
XRNR4018-1.0uH/N	1.0 $\pm$ 30%	0.025	4.20	2.00	80
XRNR4018-1.5uH/N	1.5 $\pm$ 30%	0.030	3.35	1.80	65
XRNR4018-2.2uH/M	2.2 $\pm$ 20%	0.045	2.70	1.65	52
XRNR4018-3.3uH/M	3.3 $\pm$ 20%	0.070	2.45	1.23	44
XRNR4018-4.7uH/M	4.7 $\pm$ 20%	0.090	1.70	1.20	34
XRNR4018-6.8uH/M	6.8 $\pm$ 20%	0.110	1.45	1.06	29
XRNR4018-10uH/M	10 $\pm$ 20%	0.180	1.30	0.84	24
XRNR4018-15uH/M	15 $\pm$ 20%	0.250	0.94	0.65	19
XRNR4018-22uH/M	22 $\pm$ 20%	0.360	0.80	0.59	16
XRNR4018-33uH/M	33 $\pm$ 20%	0.530	0.56	0.49	12
XRNR4018-47uH/M	47 $\pm$ 20%	0.650	0.57	0.42	10
XRNR4018-68uH/M	68 $\pm$ 20%	1.000	0.47	0.32	8.3
XRNR4018-100uH/M	100 $\pm$ 20%	1.750	0.40	0.25	6.5
XRNR4018-150uH/M	150 $\pm$ 20%	2.500	0.31	0.22	5.5
XRNR4018-220uH/M	220 $\pm$ 20%	4.000	0.27	0.17	4.0
XRNR4018-330uH/M	330 $\pm$ 20%	6.500	0.20	0.14	2.2

Remark: 1. Inductance Tested at 100kHz, 1Vrms (20°C)

2. Isat: DC current at which the inductance drops approximate 30% from its value without current;

3. Irms: DC current that causes the temperature rise ( $\Delta T = 40^\circ C$ ) from 25°C ambient.

4. Operating Temperature : -25°C ~ +125°C



● SPECIFICATION TABLE:

PART NUMBER 品名	INDUCTANCE ( $\mu$ H) 电感值	DCR ( $\pm$ 30%) ( $\Omega$ ) 直流电阻	Isat (Max.) (A) 饱和电流	Irms (Max.) (A) 额定电流	S.R.F.(Min.) (MHz) 自谐频率
XRNR4020-1.0uH/N	1.0 $\pm$ 30%	0.029	4.78	2.15	75
XRNR4020-1.2uH/N	1.2 $\pm$ 30%	0.029	5.10	2.15	72
XRNR4020-1.5uH/N	1.5 $\pm$ 30%	0.035	4.45	1.98	71
XRNR4020-2.2uH/N	2.2 $\pm$ 30%	0.040	3.40	1.85	49
XRNR4020-3.3uH/M	3.3 $\pm$ 20%	0.070	3.20	1.40	44
XRNR4020-4.7uH/M	4.7 $\pm$ 20%	0.075	2.35	1.34	42
XRNR4020-5.6uH/M	5.6 $\pm$ 20%	0.090	2.20	1.22	30
XRNR4020-6.8uH/M	6.8 $\pm$ 20%	0.125	2.00	1.04	33
XRNR4020-8.2uH/M	8.2 $\pm$ 20%	0.125	1.75	1.04	27
XRNR4020-10uH/M	10 $\pm$ 20%	0.165	1.60	0.90	26
XRNR4020-15uH/M	15 $\pm$ 20%	0.230	1.35	0.77	24
XRNR4020-22uH/M	22 $\pm$ 20%	0.350	1.05	0.62	15
XRNR4020-33uH/M	33 $\pm$ 20%	0.550	0.85	0.49	11
XRNR4020-47uH/M	47 $\pm$ 20%	0.710	0.74	0.44	10
XRNRS4020-56uH/M	56 $\pm$ 20%	0.800	0.66	0.41	10
XRNR4020-68uH/M	68 $\pm$ 20%	1.060	0.61	0.36	7.7
XRNR4020-82uH/M	82 $\pm$ 20%	1.170	0.50	0.34	7.2
XRNR4020-100uH/M	100 $\pm$ 20%	1.550	0.48	0.31	6.3

Remark: 1. Inductance Tested at 100kHz, 1Vrms (20°C)

2. Isat: DC current at which the inductance drops approximate 30% from its value without current;
3. Irms: DC current that causes the temperature rise ( $\Delta T = 40^\circ\text{C}$ ) from 25°C ambient.
4. Operating Temperature :  $-25^\circ\text{C} \sim +125^\circ\text{C}$

● SPECIFICATION TABLE:

PART NUMBER 品名	INDUCTANCE ( $\mu$ H) 电感值	DCR ( $\pm$ 30%) ( $\Omega$ ) 直流电阻	Isat (Max.) (A) 饱和电流	Irms (Max.) (A) 额定电流	S.R.F.(Min.) (MHz) 自谐频率
XRNR4030-1uH/N	1.0 $\pm$ 30%	0.016	5.26	4.14	70
XRNR4030-1.5uH/N	1.5 $\pm$ 30%	0.020	4.84	3.34	62
XRNR4030-2.2uH/N	2.2 $\pm$ 30%	0.030	4.40	2.95	52
XRNR4030-3.3uH/M	3.3 $\pm$ 20%	0.040	3.30	2.40	38
XRNR4030-4.7uH/M	4.7 $\pm$ 20%	0.060	2.90	2.00	31
XRNR4030-6.8uH/M	6.8 $\pm$ 20%	0.090	2.75	1.60	24
XRNR4030-10uH/M	10 $\pm$ 20%	0.100	1.95	1.50	21
XRNR4030-15uH/M	15 $\pm$ 20%	0.190	1.65	1.11	16
XRNR4030-22uH/M	22 $\pm$ 20%	0.225	1.30	1.00	10
XRNR4030-33uH/M	33 $\pm$ 20%	0.330	1.10	0.84	10
XRNR4030-47uH/M	47 $\pm$ 20%	0.445	0.95	0.72	8.4
XRNR4030-68uH/M	68 $\pm$ 20%	0.868	0.72	0.52	7
XRNR4030-100uH/M	100 $\pm$ 20%	1.150	0.60	0.45	5.6
XRNR4030-150uH/M	150 $\pm$ 20%	1.800	0.50	0.3	4
XRNR4030-220uH/M	220 $\pm$ 20%	2.500	0.40	0.35	4.2
XRNR4030-330uH/M	330 $\pm$ 20%	4.000	0.30	0.25	6.8
XRNR4030-470uH/M	470 $\pm$ 20%	7.200	0.30	0.2	2
XRNR4030-680uH/M	680 $\pm$ 20%	7.580	0.19	0.14	1.2

Remark: 1. Inductance Tested at 100kHz, 1Vrms (20 $^{\circ}$ C)

2. Isat: DC current at which the inductance drops approximate 30% from its value without current;
3. Irms: DC current that causes the temperature rise ( $\Delta$ T =40 $^{\circ}$ C ) from 25 $^{\circ}$ C ambient.
4. Operating Temperature : -25 $^{\circ}$ C ~ +125 $^{\circ}$ C

● SPECIFICATION TABLE:

PART NUMBER 品名	INDUCTANCE ( $\mu$ H) 电感值	DCR ( $\pm$ 30%) ( $\Omega$ ) 直流电阻	Isat (Max.) (A) 饱和电流	Irms (Max.) (A) 额定电流	S.R.F.(Min.) (MHz) 自谐频率
XRNR5020-1.0uH/N	1.0 $\pm$ 30%	0.020	4.10	3.80	114
XRNR5020-1.5uH/N	1.5 $\pm$ 30%	0.030	4.10	3.20	68
XRNR5020-2.2uH/N	2.2 $\pm$ 30%	0.040	3.20	2.70	57
XRNR5020-3.3uH/N	3.3 $\pm$ 30%	0.050	2.55	2.30	46
XRNR5020-4.7uH/M	4.7 $\pm$ 20%	0.057	2.50	2.20	37
XRNR5020-6.8uH/M	6.8 $\pm$ 20%	0.083	2.05	1.80	30
XRNR5020-8.2uH/M	8.2 $\pm$ 20%	0.098	1.85	1.65	26
XRNR5020-10uH/M	10 $\pm$ 20%	0.120	1.70	1.55	24
XRNR5020-15uH/M	15 $\pm$ 20%	0.165	1.35	1.25	20
XRNR5020-18uH/M	18 $\pm$ 20%	0.200	1.25	1.15	16
XRNR5020-22uH/M	22 $\pm$ 20%	0.250	1.15	1.10	14
XRNR5020-33uH/M	33 $\pm$ 20%	0.400	0.92	0.90	10
XRNR5020-47uH/M	47 $\pm$ 20%	0.580	0.77	0.75	7
XRNRS5020-68uH/M	68 $\pm$ 20%	0.740	0.65	0.64	6
XRNR5020-100uH/M	100 $\pm$ 20%	1.100	0.53	0.40	6

Remark: 1. Inductance Tested at 100kHz, 1Vrms (20 $^{\circ}$ C)

2. Isat: DC current at which the inductance drops approximate 30% from its value without current;

3. Irms: DC current that causes the temperature rise ( $\Delta$ T =40 $^{\circ}$ C ) from 25 $^{\circ}$ C ambient.

4. Operating Temperature : -25 $^{\circ}$ C ~ +125 $^{\circ}$ C

● SPECIFICATION TABLE:

PART NUMBER 品名	INDUCTANCE ( $\mu$ H) 电感值	DCR ( $\pm$ 30%) ( $\Omega$ ) 直流电阻	Isat (Max.) (A) 饱和电流	Irms (Max.) (A) 额定电流	S.R.F.(Min.) (MHz) 自谐频率
XRNR5040-1.0uH/N	1.0 $\pm$ 30%	0.012	7.35	4.90	117
XRNR5040-1.2uH/N	1.2 $\pm$ 30%	0.016	6.50	4.15	110
XRNR5040-1.5uH/N	1.5 $\pm$ 30%	0.018	6.30	4.00	86
XRNR5040-2.2uH/N	2.2 $\pm$ 30%	0.019	4.90	3.80	50
XRNR5040-3.3uH/N	3.3 $\pm$ 30%	0.024	3.95	3.40	32
XRNR5040-4.7uH/M	4.7 $\pm$ 20%	0.032	3.50	3.00	28
XRNR5040-5.6uH/M	5.6 $\pm$ 20%	0.035	3.00	2.80	27
XRNR5040-6.8uH/M	6.8 $\pm$ 20%	0.043	2.90	2.50	21
XRNR5040-10uH/M	10 $\pm$ 20%	0.064	2.35	2.10	18
XRNR5040-15uH/M	15 $\pm$ 20%	0.086	2.00	2.00	13
XRNR5040-22uH/M	22 $\pm$ 20%	0.129	1.60	1.50	11
XRNRS5040-33uH/M	33 $\pm$ 20%	0.188	1.30	1.20	9.1
XRNR5040-47uH/M	47 $\pm$ 20%	0.272	1.10	1.00	6.7
XRNR5040-68uH/M	68 $\pm$ 20%	0.400	0.90	0.80	5.7
XRNRS5040-100uH/M	100 $\pm$ 20%	0.560	0.75	0.70	4.7
XRNRS5040-150uH/M	150 $\pm$ 20%	0.750	0.65	0.60	5
XRNR5040-220uH/M	220 $\pm$ 20%	1.280	0.40	0.38	3
XRNR5040-1mH/M	1000 $\pm$ 20%	6.200	0.25	0.25	2
XRNR5040-2.2mH/M	2200 $\pm$ 20%	13.000	0.10	0.10	2

Remark: 1. Inductance Tested at 100kHz, 1Vrms (20°C)

2. Isat: DC current at which the inductance drops approximate 30% from its value without current;
3. Irms: DC current that causes the temperature rise ( $\Delta T = 40^\circ C$ ) from 25°C ambient.
4. Operating Temperature : -25°C ~ +125°C

● SPECIFICATION TABLE:

PART NUMBER 品名	INDUCTANCE ( $\mu$ H) 电感值	DCR ( $\pm$ 30%) ( $\Omega$ ) 直流电阻	Isat (Max.) (A) 饱和电流	Irms (Max.) (A) 额定电流	S.R.F.(Min.) (MHz) 自谐频率
XRNR6020-0.68uH/N	0.68 $\pm$ 30%	0.017	6.55	3.80	115
XRNR6020-0.82uH/N	0.82 $\pm$ 30%	0.017	5.30	3.80	110
XRNR6020-1.0uH/N	1.0 $\pm$ 30%	0.020	4.15	3.50	100
XRNR6020-1.5uH/N	1.5 $\pm$ 30%	0.022	4.25	3.20	79
XRNR6020-2.2uH/N	2.2 $\pm$ 30%	0.028	3.75	2.75	61
XRNR6020-3.3uH/N	3.3 $\pm$ 30%	0.035	3.15	2.60	51
XRNR6020-4.7uH/M	4.7 $\pm$ 20%	0.058	3.00	2.00	41
XRNR6020-6.8uH/M	6.8 $\pm$ 20%	0.079	2.20	1.80	31
XRNR6020-10uH/M	10 $\pm$ 20%	0.105	1.75	1.40	27
XRNR6020-12uH/M	12 $\pm$ 20%	0.120	1.45	1.30	25
XRNR6020-15uH/M	15 $\pm$ 20%	0.145	1.20	1.20	21
XRNR6020-18uH/M	18 $\pm$ 20%	0.180	1.20	1.08	18
XRNR6020-22uH/M	22 $\pm$ 20%	0.204	1.05	1.00	16
XRNR6020-33uH/M	33 $\pm$ 20%	0.300	0.95	0.84	11
XRNR6020-47uH/M	47 $\pm$ 20%	0.430	0.70	0.80	10

Remark: 1. Inductance Tested at 100kHz, 1Vrms (20°C)

2. Isat: DC current at which the inductance drops approximate 30% from its value without current;
3. Irms: DC current that causes the temperature rise ( $\Delta T = 40^\circ C$ ) from 25°C ambient.
4. Operating Temperature : -25°C ~ +125°C

● SPECIFICATION TABLE:

PART NUMBER 品名	INDUCTANCE ( $\mu$ H) 电感值	DCR ( $\pm$ 30%) ( $\Omega$ ) 直流电阻	Isat (Max.) (A) 饱和电流	Irms (Max.) (A) 额定电流	S.R.F.(Min.) (MHz) 自谐频率
XRNR6028-1.0uH/N	1.0 $\pm$ 30%	0.012	5.75	5.20	70
XRNR6028-1.5uH/N	1.5 $\pm$ 30%	0.015	6.00	4.58	65
XRNR6028-2.2uH/N	2.2 $\pm$ 30%	0.020	5.10	3.75	48
XRNR6028-3.3uH/N	3.3 $\pm$ 30%	0.025	4.15	3.48	41
XRNR6028-4.7uH/N	4.7 $\pm$ 30%	0.030	3.00	3.08	35
XRNR6028-6.8uH/M	6.8 $\pm$ 20%	0.047	2.60	2.40	27
XRNR6028-10uH/M	10 $\pm$ 20%	0.072	2.04	1.95	23
XRNR6028-12uH/M	12 $\pm$ 20%	0.080	1.80	1.85	18
XRNR6028-15uH/M	15 $\pm$ 20%	0.125	1.75	1.45	18
XRNR6028-18uH/M	18 $\pm$ 20%	0.120	1.52	1.45	15
XRNR6028-22uH/M	22 $\pm$ 20%	0.140	1.45	1.40	14
XRNR6028-33uH/M	33 $\pm$ 20%	0.185	1.35	1.22	12
XRNR6028-47uH/M	47 $\pm$ 20%	0.315	1.15	1.06	9.5
XRNR6028-68uH/M	68 $\pm$ 20%	0.360	0.80	0.86	7.7
XRNR6028-82uH/M	82 $\pm$ 20%	0.500	0.80	0.70	7.7
XRNR6028-100uH/M	100 $\pm$ 20%	0.500	0.65	0.70	7.1
XRNR6028-1mH/M	1000 $\pm$ 20%	5.800	0.18	0.20	1.5

Remark: 1. Inductance Tested at 100kHz, 1Vrms (20 $^{\circ}$ C)

2. Isat: DC current at which the inductance drops approximate 30% from its value without current;
3. Irms: DC current that causes the temperature rise ( $\Delta T = 40^{\circ}C$ ) from 25 $^{\circ}$ C ambient.
4. Operating Temperature : -25 $^{\circ}$ C ~ +125 $^{\circ}$ C

● SPECIFICATION TABLE:

PART NUMBER 品名	INDUCTANCE ( $\mu$ H) 电感值	DCR ( $\pm$ 30%) ( $\Omega$ ) 直流电阻	Isat (Max.) (A) 饱和电流	Irms (Max.) (A) 额定电流	S.R.F.(Min.) (MHz) 自谐频率
XRNR6045-1.0uH/N	1.0 $\pm$ 30%	0.011	9.85	5.14	100
XRNR6045-1.5uH/N	1.5 $\pm$ 30%	0.012	8.80	4.95	65
XRNR6045-2.2uH/N	2.2 $\pm$ 30%	0.014	6.75	4.60	52
XRNR6045-3.3uH/N	3.3 $\pm$ 30%	0.024	5.90	3.70	32
XRNR6045-4.7uH/M	4.7 $\pm$ 20%	0.031	4.97	3.30	24
XRNR6045-6.8uH/M	6.8 $\pm$ 20%	0.035	3.90	3.00	20
XRNR6045-10uH/M	10 $\pm$ 20%	0.048	3.20	2.45	15
XRNR6045-15uH/M	15 $\pm$ 20%	0.068	2.50	2.05	12
XRNR6045-22uH/M	22 $\pm$ 20%	0.089	2.05	1.80	10
XRNR6045-33uH/M	33 $\pm$ 20%	0.137	1.65	1.45	7.8
XRNR6045-47uH/M	47 $\pm$ 20%	0.200	1.40	1.20	6.4
XRNR6045-56uH/M	56 $\pm$ 20%	0.221	1.30	1.10	6.4
XRNR6045-68uH/M	68 $\pm$ 20%	0.289	1.20	1.00	6.4
XRNR6045-100uH/M	100 $\pm$ 20%	0.433	0.95	0.80	4.2
XRNR6045-120uH/M	120 $\pm$ 20%	0.484	0.85	0.77	4.2
XRNR6045-150uH/M	150 $\pm$ 20%	0.580	0.80	0.70	4.2
XRNR6045-220uH/M	220 $\pm$ 20%	0.834	0.70	0.59	3.5
XRNR6045-330uH/M	330 $\pm$ 20%	1.270	0.57	0.57	2.8
XRNR6045-470uH/M	470 $\pm$ 20%	1.800	0.50	0.42	2
XRNR6045-680uH/M	680 $\pm$ 20%	2.500	0.42	0.33	1.7
XRNR6045-1mH/M	1000 $\pm$ 20%	4.500	0.30	0.30	1.4
XRNR6045-1.5mH/M	1500 $\pm$ 20%	6.500	0.24	0.21	0.8

Remark: 1. Inductance Tested at 100kHz, 1Vrms (20°C)

2. Isat: DC current at which the inductance drops approximate 30% from its value without current;
3. Irms: DC current that causes the temperature rise ( $\Delta T = 40^\circ C$ ) from 25°C ambient.
4. Operating Temperature : -25°C ~ +125°C

● SPECIFICATION TABLE:

PART NUMBER 品名	INDUCTANCE ( $\mu$ H) 电感值	DCR ( $\pm$ 30%) ( $\Omega$ ) 直流电阻	Isat (Max.) (A) 饱和电流	Irms (Max.) (A) 额定电流	S.R.F.(Min.) (MHz) 自谐频率
XRNR8040-0.82uH/N	0.82 $\pm$ 30%	0.008	13.80	6.30	94
XRNR8040-1.0uH/N	1.0 $\pm$ 30%	0.008	9.85	6.30	89
XRNR8040-1.5uH/N	1.5 $\pm$ 30%	0.010	8.15	5.65	67
XRNR8040-2.2uH/N	2.2 $\pm$ 30%	0.012	7.10	5.15	41
XRNR8040-3.3uH/N	3.3 $\pm$ 30%	0.017	6.50	4.40	27
XRNR8040-4.7uH/N	4.7 $\pm$ 30%	0.019	5.90	4.10	24
XRNR8040-6.8uH/M	6.8 $\pm$ 20%	0.024	4.55	3.60	20
XRNR8040-8.2uH/M	8.2 $\pm$ 20%	0.026	4.20	3.45	17
XRNR8040-10uH/M	10 $\pm$ 20%	0.042	3.60	3.30	15
XRNR8040-15uH/M	15 $\pm$ 20%	0.047	2.95	2.60	12
XRNRS8040-18uH/M	18 $\pm$ 20%	0.053	2.70	2.40	11
XRNRS8040-22uH/M	22 $\pm$ 20%	0.069	2.40	2.10	9.5
XRNRS8040-33uH/M	33 $\pm$ 20%	0.097	2.05	1.80	7.8
XRNRS8040-47uH/M	47 $\pm$ 20%	0.136	1.75	1.55	6.4
XRNRS8040-68uH/M	68 $\pm$ 20%	0.196	1.45	1.25	4.9
XRNRS8040-82uH/M	82 $\pm$ 20%	0.225	1.30	1.15	4.9
XRNRS8040-100uH/M	100 $\pm$ 20%	0.290	1.15	1.00	4.2
XRNRS8040-120uH/M	120 $\pm$ 20%	0.334	1.05	0.95	3.5
XRNRS8040-150uH/M	150 $\pm$ 20%	0.410	1.10	0.85	3.5
XRNRS8040-220uH/M	220 $\pm$ 20%	0.599	0.85	0.80	3.5
XRNRS8040-330uH/M	330 $\pm$ 20%	0.889	0.68	0.64	2.8
XRNRS8040-470uH/M	470 $\pm$ 20%	1.260	0.60	0.54	2.1
XRNRS8040-680uH/M	680 $\pm$ 20%	2.040	0.50	0.45	1.7
XRNRS8040-1mH/M	1000 $\pm$ 20%	2.800	0.40	0.35	1.4

Remark: 1. Inductance Tested at 100kHz, 1Vrms (20°C)

2. Isat: DC current at which the inductance drops approximate 30% from its value without current;
3. Irms: DC current that causes the temperature rise ( $\Delta T = 40^\circ C$ ) from 25°C ambient.
4. Operating Temperature : -25°C ~ +125°C



● PACKAGING SPECIFICATION :

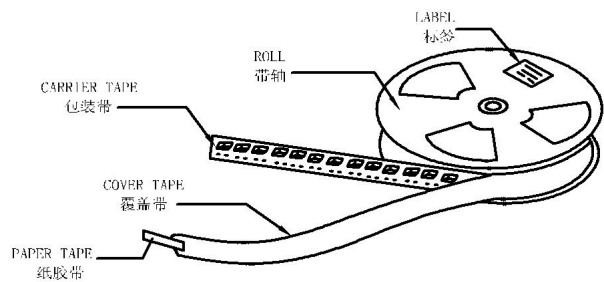
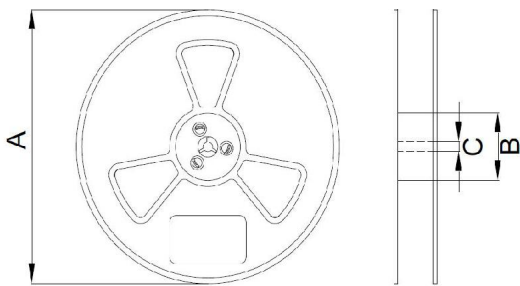
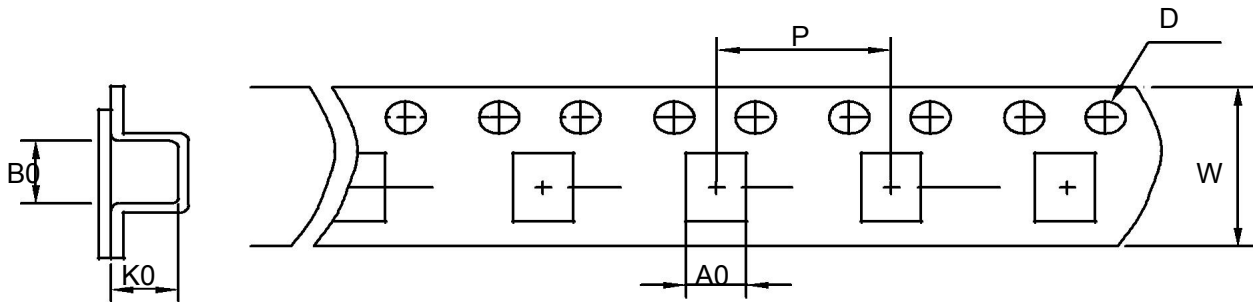

Type	Tape Dimension (mm)						Reel Dimension (mm)			Quantity (Pcs/Reel)
	W	A0	B0	K0	D	P	A	B	C	
XRNR201610	8	1.9	2.3	1.2	1.5	4	178	58	13	2000
XRNR252010	8	2.4	2.9	1.25	1.5	4	178	58	13	2000
XRNR252012	8	2.35	2.65	1.6	1.5	4	178	58	13	2000
XRNR3010	8	3.3	3.3	1.4	1.5	4	178	58	13	2000
XRNR3012	8	3.3	3.3	1.6	1.5	4	178	58	13	2000
XRNR3015	8	3.3	3.3	1.9	1.5	4	178	58	13	2000
XRNR4012	12	4.3	4.3	1.4	1.5	8	330	100	13	4000
XRNR4018	12	4.3	4.3	2.2	1.5	8	330	100	13	3000
XRNR4020	12	4.3	4.3	2.4	1.5	8	330	100	13	3000
XRNR4030	12	4.3	4.3	3.4	1.5	8	330	100	13	2000
XRNR5020	12	5.4	5.4	2.4	1.5	8	330	100	13	3000
XRNR5040	12	5.4	5.4	4.4	1.5	8	330	100	13	1500
XRNR6020	16	6.4	6.4	2.4	1.5	8	330	100	13	2500
XRNR6028	16	6.4	6.4	3.2	1.5	8	330	100	13	2000
XRNR6045	16	6.4	6.4	4.8	1.5	8	330	100	13	1500
XRNR8040	16	8.4	8.4	4.4	1.5	12	330	100	13	1000

## X-ON Electronics

Largest Supplier of Electrical and Electronic Components

*Click to view similar products for [Fixed Inductors](#) category:*

*Click to view products by [MaxLinear](#) manufacturer:*

Other Similar products are found below :

[CR32NP-100KC](#) [CR54NP-470LC](#) [70F224AI](#) [MGDQ4-00004-P](#) [MHQ1005P10NJ](#) [MHQ1005P1N0S](#) [MHQ1005P2N4S](#) [MHQ1005P3N6S](#)  
[MHQ1005P5N1S](#) [MHQ1005P8N2J](#) [PE-53601NL](#) [PE-53602NL](#) [PG0936.113NLT](#) [9220-20](#) [9310-16](#) [PM06-2N7](#) [PM06-39NJ](#) [A01TK](#)  
[1206CS-471XJ](#) [HC2-R47-R](#) [HC8-1R2-R](#) [HCF1305-3R3-R](#) [1206CS-151XG](#) [RCH664NP-140L](#) [RCH664NP-4R7M](#) [RCP1317NP-391L](#)  
[RCR110DNP-331L](#) [DH2280-4R7M](#) [DS1608C-106](#) [B10TJ](#) [B82498B3101J000](#) [ELJ-RE27NJF2](#) [1812CS-153XJ](#) [1812CS-183XJ](#) [1812CS-](#)  
[223XJ](#) [1812LS-104XJ](#) [1812LS-105XJ](#) [1812LS-124XJ](#) [1812LS-154XJ](#) [1812LS-223XJ](#) [1812LS-224XJ](#) [1812LS-563XJ](#) [1812LS-683XJ](#)  
[1812LS-824XJ](#) [NIN-FB101JTR110F](#) [NIN-FB471JTR62F](#) [NIN-FC1R5JTR220F](#) [NIN-HCR15JTRF](#) [NIN-HCR33JTRF](#) [NIN-HDR22JTRF](#)