

GENERAL DESCRIPTION

The XRP2997 is a Double Data Rate (DDR) termination voltage regulator supporting all power requirements of DDR I, II, III and IV memories and is capable of sinking or sourcing 2A continuously.

Tightly regulating its output voltage within $\pm 20\text{mV}$, the XRP2997 converts input voltages as low as 1.1V while the output voltage is adjustable through an external resistor divider or by forcing the V_{REF} pin voltage. It maintains a fast line and load transient response and only requires an output capacitance of $22\mu\text{F}$ to operate. An enable function via an external MOSFET and a soft start feature allow for a controlled implementation of power-up sequencing.

Built-in source/sink overcurrent, over-temperature and under-voltage lockout protections insure safe operation under abnormal operating conditions.

The XRP2997 meets JEDEC SSTL-2, SSTL-18, HSTL, SCSI-1 and SCSI-3 specifications for DDR SDRAM memories.

The XRP2997 is offered in a RoHS compliant, "green"/halogen free 8-pin Exposed Pad SOIC package.

APPLICATIONS

- **DDR I/II/III/IV Memory Termination**
- **Active Termination Buses**
- **Audio-Video Equipments**
- **Video-Graphics Cards**

FEATURES

- **DDR1, DDR2, DDR3 and DDR4 Support**
 - 0.75V_{TT} Generation
 - $\pm 20\text{mV}$ Output Voltage Offset
- **2 Amps Continuous Current Sourcing & Sinking**
 - 1.1V to 5.5V Wide Input Voltage Range
- **Adjustable Output Voltage**
- **Suspend to RAM(STR), Enable & Soft Start Functions**
- **Stable with 22 μF Ceramic Capacitor**
- **UVLO, Over Temperature and Over Current Protections**
- **Minimal External Components**
- **Pin/Function Compatible with SP2996B**
- **RoHS Compliant "Green"/Halogen Free 8-Pin SOIC Package**

TYPICAL APPLICATION DIAGRAM

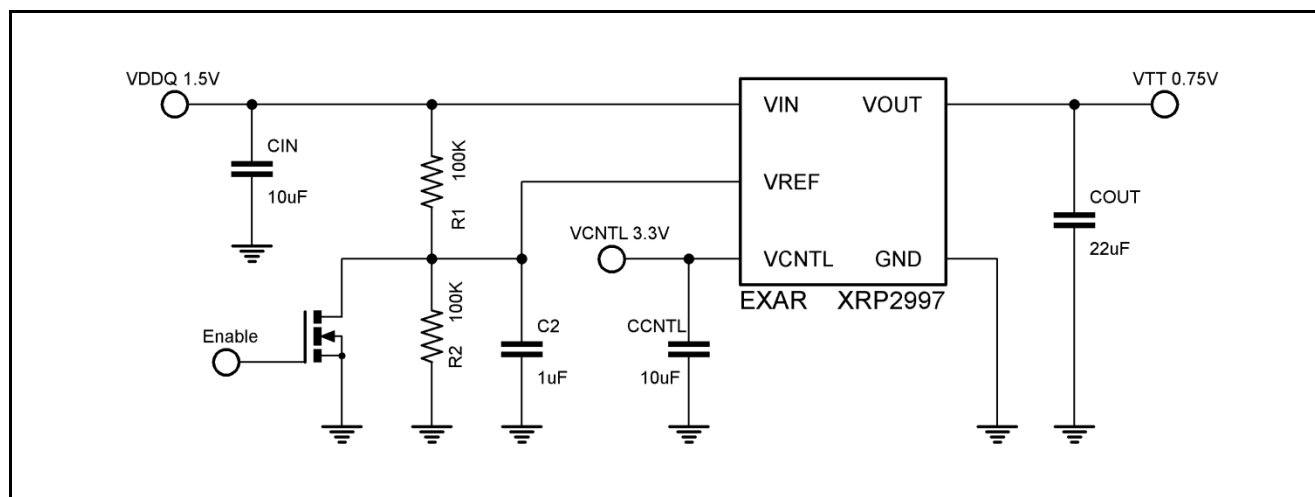

Fig. 1: XRP2997 DDRIII V_{TT} Application Diagram

ABSOLUTE MAXIMUM RATINGS

These are stress ratings only and functional operation of the device at these ratings or any other above those indicated in the operation sections of the specifications below is not implied. Exposure to absolute maximum rating conditions for extended periods of time may affect reliability.

V_{IN} , V_{REF} , V_{CNTL} -0.3V to 6.0V
 Junction Temperature Range..... -40°C to +150°C
 Storage Temperature..... -65°C to +150°C
 Lead Temperature (Soldering, 10 sec) 260°C

OPERATING RATINGS

Operating Temperature Range..... -40°C to +85°C
 Thermal Resistance θ_{JA} 60°C/W
 Thermal Resistance θ_{JC} 16°C/W

ELECTRICAL SPECIFICATIONS

Specifications are for an Operating Ambient Temperature of $T_A = 25^\circ\text{C}$ only; limits applying over the full Operating Junction Temperature range are denoted by a “*”. Minimum and Maximum limits are guaranteed through test, design, or statistical correlation. Typical values represent the most likely parametric norm at $T_A = 25^\circ\text{C}$, and are provided for reference purposes only. Unless otherwise indicated, $V_{IN} = 1.8\text{V}/1.5\text{V}$, $V_{CNTL} = 3.3\text{V}$, $V_{REF} = 0.5 \times V_{IN}$, $C_{OUT} = 22\mu\text{F}$ (ceramic), $T_A = 25^\circ\text{C}$.

Parameter	Min.	Typ.	Max.	Units	Conditions
V_{IN} , Input Voltage Range	1.1	1.8/1.5	5.5	V	Keep $V_{CNTL} \geq V_{IN}$ during power on and power off sequences (note 4)
V_{CNTL} , Input Voltage Range	2.375	3.3	5.5	V	Keep $V_{CNTL} \geq V_{IN}$ during power on and power off sequences (note 4)
V_{OUT} , Output Voltage	V_{REF}			V	$I_{OUT} = 0\text{mA}$
V_{OS} , Output Voltage Offset	-20		+20	mV	$I_{OUT} = 0\text{mA}$ (note 1)
ΔV_{LOR} , Load Regulation	-20		+20	mV	$I_{OUT} = 0.1\text{mA}$ to +2A
	-20		+20	mV	$I_{OUT} = 0.1\text{mA}$ to -2A
I_Q , Quiescent Current		2	90	μA	$V_{REF} < 0.2\text{V}$, $V_{OUT} = \text{OFF}$
I_{CNTL} , Operating Current of V_{CNTL}		1	2.5	mA	$I_{OUT} = 0\text{mA}$
I_{REF} , Bias Current of V_{REF}	0		1	μA	$V_{REF} = 1.25\text{V}$
I_{IL} , Current Limit	2.4	3		A	Source: $V_{OUT} = 0.33 \times V_{REF}$ Sink: $V_{OUT} = 0.95 \times V_{IN}$ (note 3)
R_{DSCHG} , Output Discharge Resistance		18	25	Ω	$V_{REF} = 0\text{V}$, $V_{OUT} = 0.3\text{V}$
Thermal Protection					
T_{SD} , Thermal Shutdown Temperature		160		$^\circ\text{C}$	$3.3\text{V} \leq V_{CNTL} \leq 5\text{V}$, guaranteed by design (note 4)
Thermal Shutdown Hysteresis		30		$^\circ\text{C}$	Guaranteed by design
Shutdown Specifications					
$V_{TRIGGER}$, Shutdown Threshold	0.6			V	Output ON $V_{REF} = 0\text{V} \rightarrow 1.25\text{V}$
			0.2		Output OFF $V_{REF} = 1.25\text{V} \rightarrow 0\text{V}$

Note 1: V_{OS} offset is the voltage measurement defined as V_{OUT} subtracted from V_{REF} .

Note 2: Load regulation is measured at constant junction temperature, using pulse testing with a short ON time.

Note 3: Current limit is measured by applying a short duration current pulse.

Note 4: In order to safely operate yo2ur system, V_{CNTL} must be $> V_{IN}$.

BLOCK DIAGRAM

Fig. 2: XRP2997 Block Diagram

PIN ASSIGNMENT

Fig. 3: XRP2997 Pin Assignment

PIN DESCRIPTION

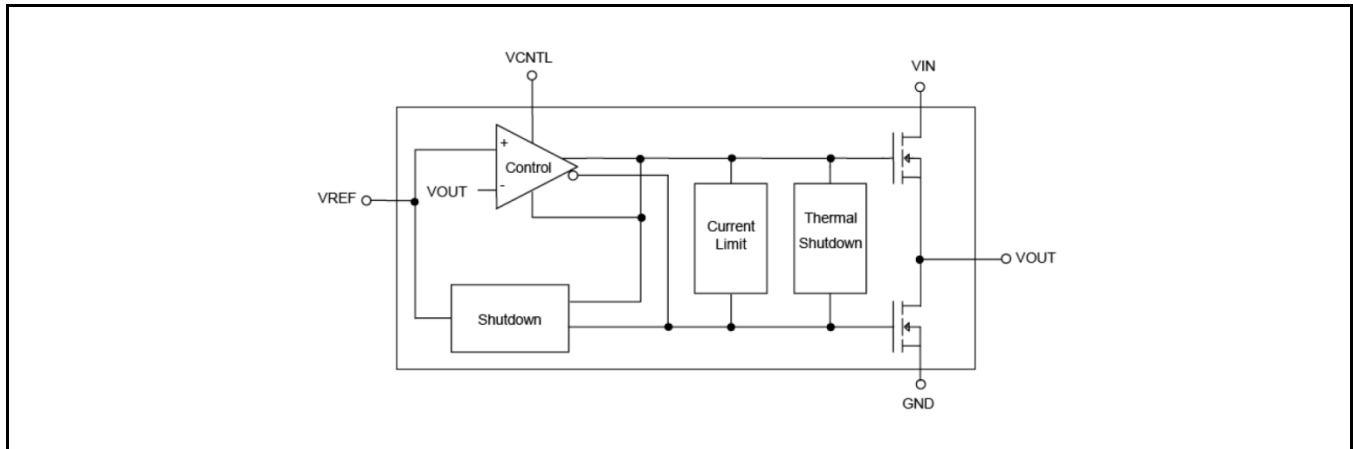
Name	Pin Number	Description
V_{IN}	1	Power Input Voltage
GND	2	Ground Signal
	Exposed Pad	
V_{REF}	3	Reference Input Voltage. This input can also be used as an enable signal; pulling this pin low shuts down the XRP2997. Refer to typical application circuit.
V_{OUT}	4	Output Voltage
NC	5, 7, 8	NC
V_{CNTRL}	6	Voltage for the driver circuit and all analog blocks

ORDERING INFORMATION⁽¹⁾

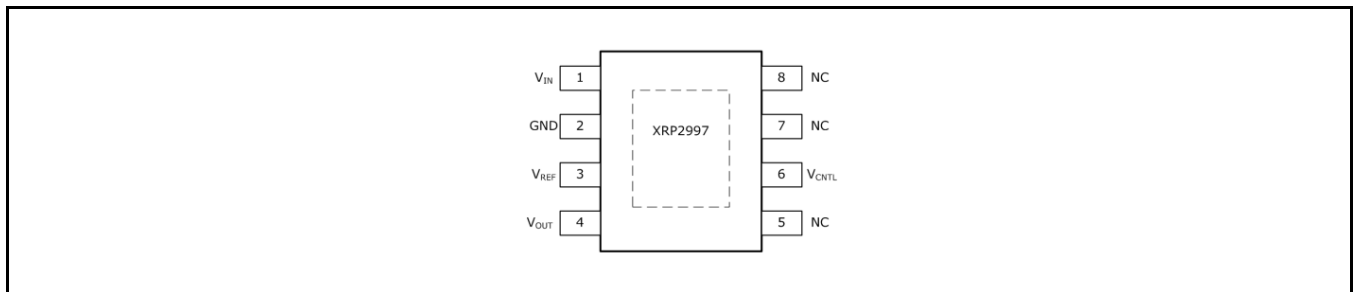
Part Number	Operating Temperature Range	Lead-Free	Package	Packing Method
XRP2997IDBTR-F	$-40^{\circ}\text{C} \leq T_A \leq +85^{\circ}\text{C}$	Yes ⁽²⁾	Exposed pad HSOIC-8 Option 1	Tape & Reel

NOTE:

1. Refer to www.exar.com/XRP2997 for most up-to-date Ordering Information
2. Visit www.exar.com for additional information on Environmental Rating.

TYPICAL PERFORMANCE CHARACTERISTICS

All data taken at $V_{IN} = 1.8V/1.5V$, $V_{CNTL} = 3.3V$, $V_{REF} = 0.5 \times V_{IN}$, $C_{OUT} = 22\mu F$ (ceramic), $T_A = 25^\circ C$, unless otherwise specified - Schematic and BOM from Application Information section of this datasheet.

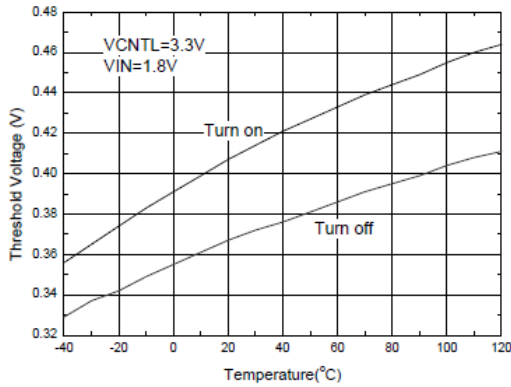

Fig. 4: Turn on and turn off vs. Temperature

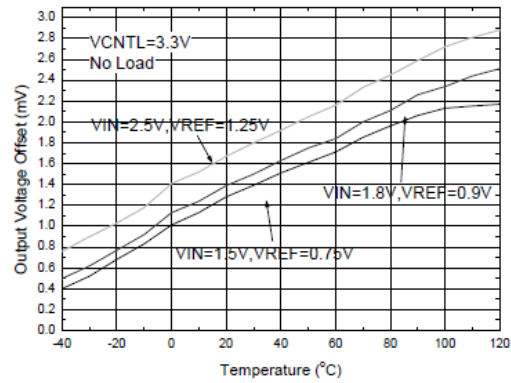

Fig. 5: Output Voltage vs. Temperature

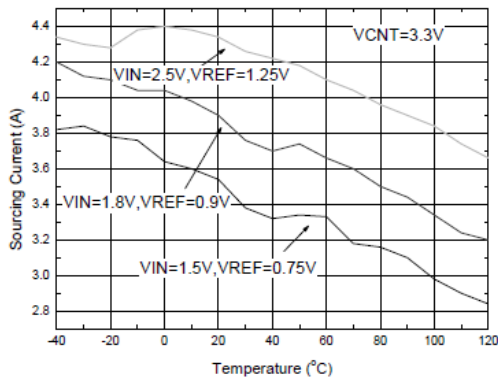

Fig. 6: Current limit (sourcing) vs. Temperature

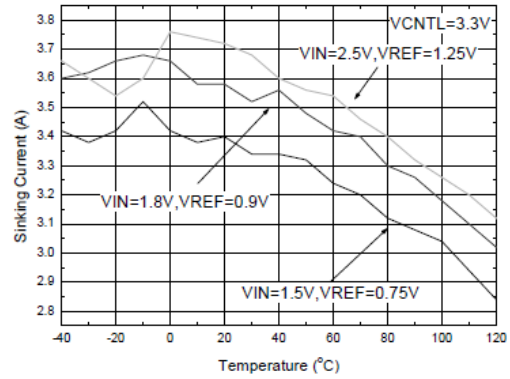

Fig. 7: Current limit (sinking) vs. Temperature

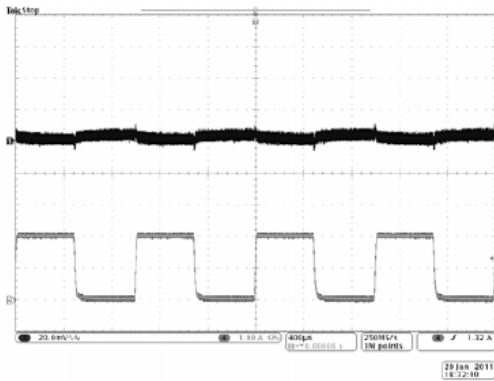

Fig. 8: $V_{IN}=1.5V$, $V_{REF}=0.75V$ source response

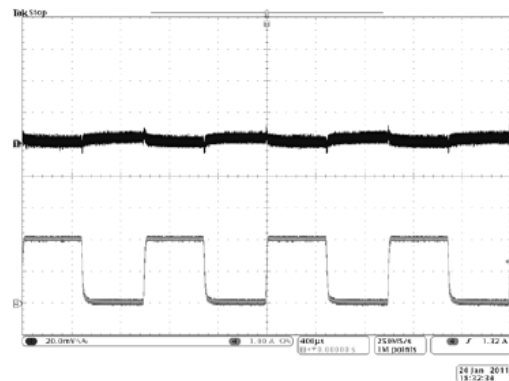

Fig. 9: $V_{IN}=1.8V$, $V_{REF}=0.9V$ source response

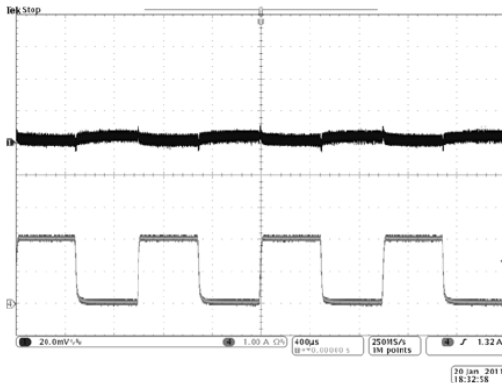

Fig. 10: $V_{IN}=2.5V$, $V_{REF}=1.25V$ source response

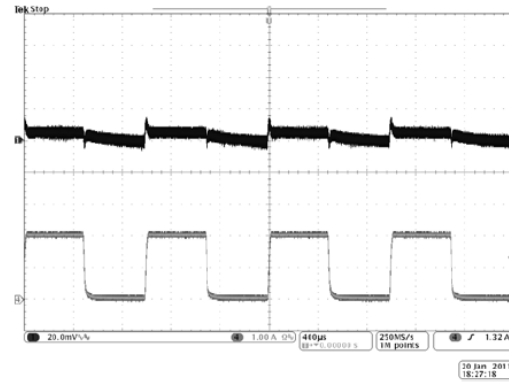

Fig. 11: $V_{IN}=1.5V$, $V_{REF}=0.75V$ sink response

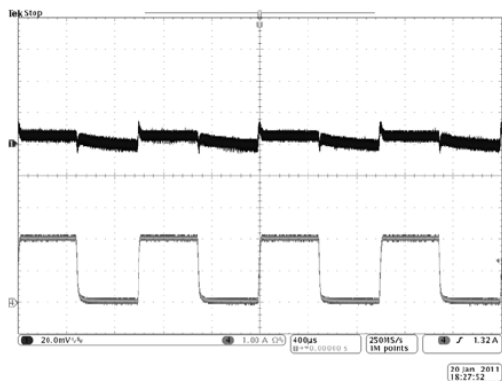

Fig. 9: $V_{IN}=1.8V$, $V_{REF}=0.9V$ sink response

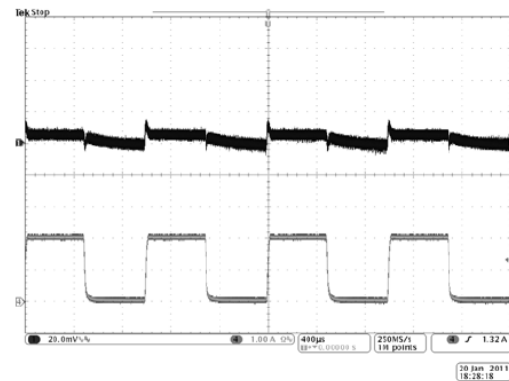

Fig. 10: $V_{IN}=2.5V$, $V_{REF}=1.25V$ sink response

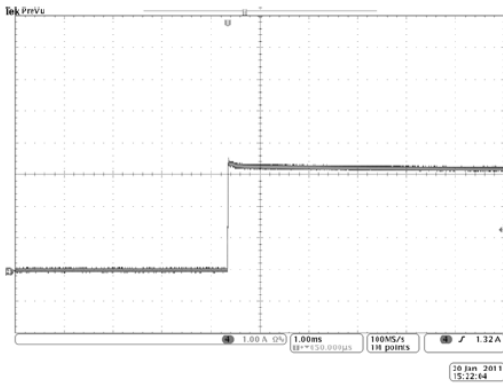

Fig. 14: $V_{IN}=1.5V$, $V_{REF}=0.75V$ source short circuit

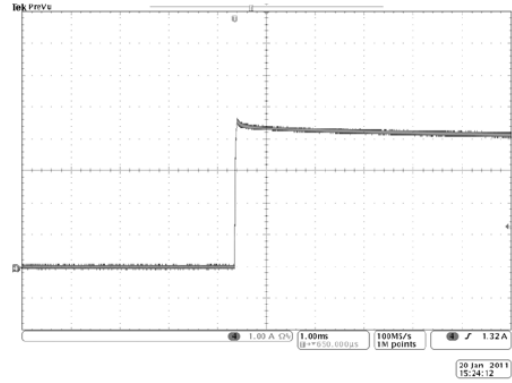

Fig. 15: $V_{IN}=1.8V$, $V_{REF}=0.9V$ source short circuit

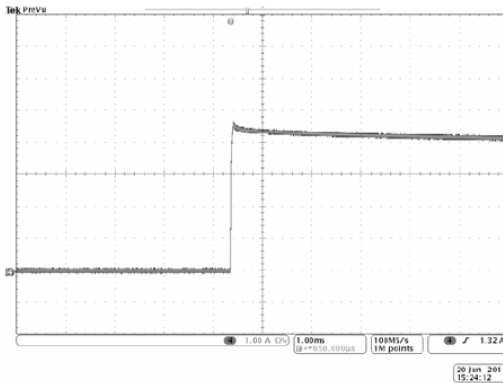

Fig. 11: $V_{IN}=2.5V$, $V_{REF}=1.25V$ source short circuit

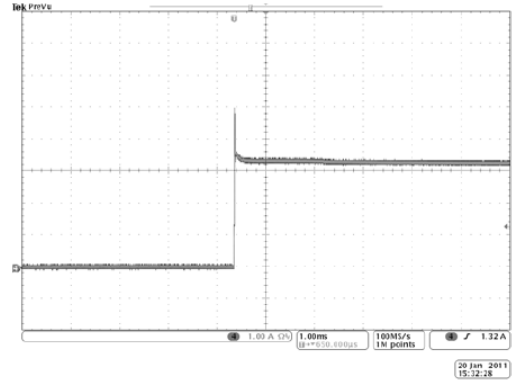

Fig. 12: $V_{IN}=1.5V$, $V_{REF}=0.75V$ sink short circuit

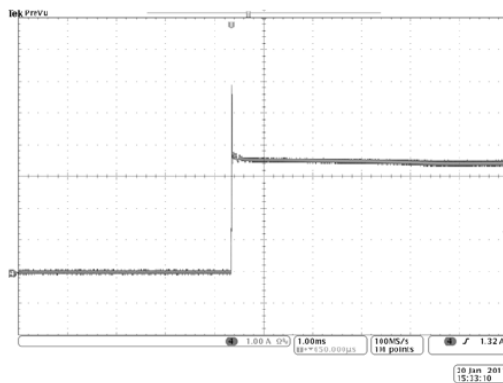

Fig. 13: $V_{IN}=1.8V$, $V_{REF}=0.9V$ sink short circuit

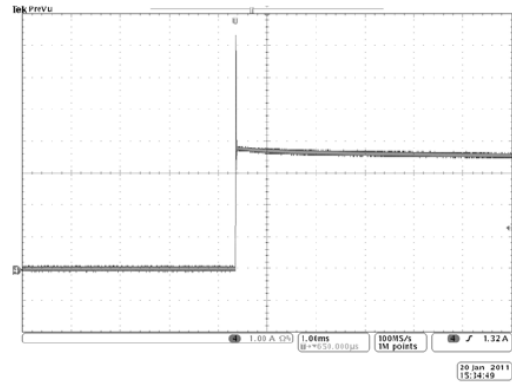

Fig. 14: $V_{IN}=2.5V$, $V_{REF}=1.25V$ sink short circuit

APPLICATION INFORMATION**INPUT CAPACITOR C_{IN}**

Select the input capacitor C_{IN} for voltage rating, RMS current rating and capacitance. The voltage rating should be at least 50% higher than the regulator's maximum input voltage. The value of this capacitor, its charge, should be selected in order to be able to supply enough current to the XRP2997 in the event of a transient increase of source current required. A minimum value of 10 μ F is advised while a

recommended value of 47 μ F is recommended for optimum transient response performance.

LAYOUT CONSIDERATIONS

The XRP2997 is offered in the 8-pin exposed-pad SOIC package in order to facilitate power dissipation (heat dissipation). Power dissipation can be maximized by soldering the exposed pad to a large land area on top layer of PCB and by using vias to connect the exposed pad to an interlayer(s) or bottom layer. All capacitors should be placed as close as possible to the respective pins.

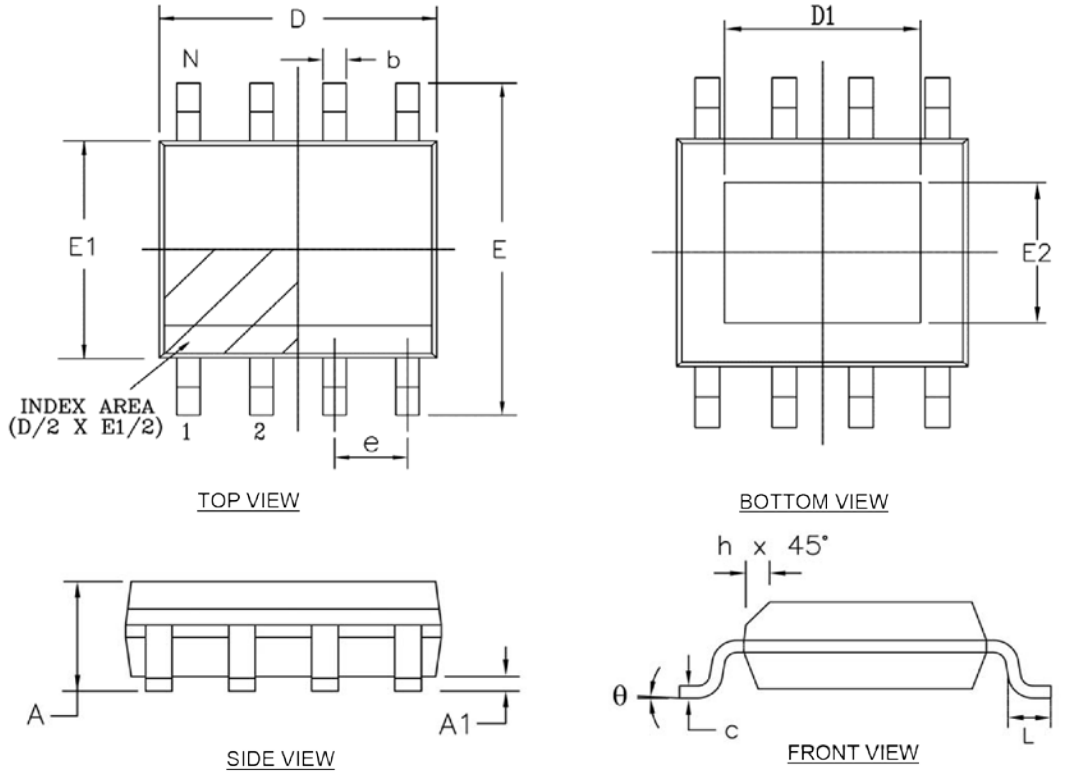
PACKAGE SPECIFICATION
8-PIN HSOIC (EXPOSED PAD) OPTION 1

8 Pin HSOICN JEDEC MS-012 Variation BA			
SYMBOLS	DIMENSIONS IN MM		
	MIN	NOM	MAX
A	1.35		1.75
A1	0.00		0.15
b	0.31		0.51
c	0.17		0.25
D	4.80		5.00
D1	1.50		3.50
E	5.80		6.20
E1	3.80		4.00
E2	1.00		2.55
e	1.27 BSC		
h	0.25		0.50
L	0.40		1.27
θ	0°		8°
N	8		

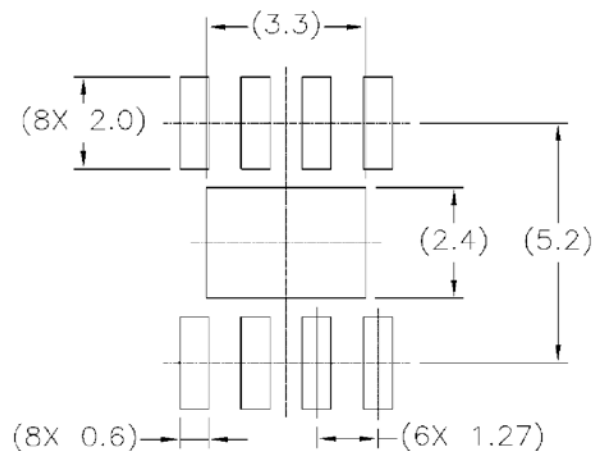
TERMINAL DETAILS

NOTE : ALL DIMENSIONS ARE IN MILLIMETERS, ANGLES ARE IN DEGREE

Drawing No. : POD_0000125

Revision: A

REVISION HISTORY

Revision	Date	Description
1.0.0	07/22/2011	Initial release of datasheet
1.1.0	01/09/2012	Corrected part number in ordering information
1.1.1	03/29/2012	Corrected turn on threshold from 0.8V to 0.6V. Typographical error.
1.2.0	10/29/2012	Reformat of datasheet Updated typical application schematics (figure 1) Addition of CIN selection under Application Information section
1.2.1	8/17/2017	Added DDR IV. Updated to MaxLinear logo. Updated format, ordering information and package drawing.

FOR FURTHER ASSISTANCE

Email:

<mailto:customersupport@exar.com><mailto:powertechsupport@exar.com>**Corporate Headquarters:**

5966 La Place Court

Suite 100

Carlsbad, CA 92008

Tel.: +1 (760) 692 0711

Fax: +1 (760)444-8598

www.maxlinear.com**High Performance Analog:**

48720 Kato Road

Fremont, CA 94538 – USA

Tel.: +1 (510) 668-7000

Fax: +1 (510) 668-7030

www.exar.com

The content of this document is furnished for informational use only, is subject to change without notice, and should not be construed as a commitment by MaxLinear, Inc.. MaxLinear, Inc. assumes no responsibility or liability for any errors or inaccuracies that may appear in the informational content contained in this guide. Complying with all applicable copyright laws is the responsibility of the user. Without limiting the rights under copyright, no part of this document may be reproduced into, stored in, or introduced into a retrieval system, or transmitted in any form or by any means (electronic, mechanical, photocopying, recording, or otherwise), or for any purpose, without the express written permission of MaxLinear, Inc.

MaxLinear, Inc. does not recommend the use of any of its products in life support applications where the failure or malfunction of the product can reasonably be expected to cause failure of the life support system or to significantly affect its safety or effectiveness. Products are not authorized for use in such applications unless MaxLinear, Inc. receives, in writing, assurances to its satisfaction that: (a) the risk of injury or damage has been minimized; (b) the user assumes all such risks; (c) potential liability of MaxLinear, Inc. is adequately protected under the circumstances.

MaxLinear, Inc. may have patents, patent applications, trademarks, copyrights, or other intellectual property rights covering subject matter in this document. Except as expressly provided in any written license agreement from MaxLinear, Inc., the furnishing of this document does not give you any license to these patents, trademarks, copyrights, or other intellectual property.

Company and product names may be registered trademarks or trademarks of the respective owners with which they are associated.

© 2012 - 2017 MaxLinear, Inc. All rights reserved

X-ON Electronics

Largest Supplier of Electrical and Electronic Components

Click to view similar products for [LDO Voltage Regulators](#) category:

Click to view products by [MaxLinear](#) manufacturer:

Other Similar products are found below :

[AP7363-SP-13](#) [L79M05TL-E](#) [PT7M8202B12TA5EX](#) [TCR3DF185,LM\(CT](#) [MP2013GQ-33-Z](#) [059985X](#) [NCP4687DH15T1G](#) [701326R](#)
[TCR2EN28,LF\(S](#) [NCV8170AXV250T2G](#) [TCR2EN18,LF\(S](#) [AP7315-25W5-7](#) [IFX30081LDVGRNXUMA1](#) [NCV47411PAAJR2G](#)
[AP2113KTR-G1](#) [AP2111H-1.2TRG1](#) [ZLDO1117QK50TC](#) [AZ1117IH-1.8TRG1](#) [TCR3DG12,LF](#) [MIC5514-3.3YMT-T5](#) [MIC5512-1.2YMT-](#)
[T5](#) [MIC5317-2.8YM5-T5](#) [SCD7912BTG](#) [NCP154MX180270TAG](#) [SCD33269T-5.0G](#) [NCV8170BMX330TCG](#) [NCV8170AMX120TCG](#)
[NCP706ABMX300TAG](#) [NCP153MX330180TCG](#) [NCP114BMX075TCG](#) [MC33269T-3.5G](#) [CAT6243-ADJCMT5T](#) [TCR3DG33,LF](#)
[AP2127N-1.0TRG1](#) [TCR4DG35,LF](#) [LT1117CST-3.3](#) [LT1117CST-5](#) [TAR5S15U\(TE85L,F\)](#) [TAR5S18U\(TE85L,F\)](#) [TCR3UG19A,LF](#)
[TCR4DG105,LF](#) [NCV8170AMX360TCG](#) [MIC94310-NYMT-T5](#) [NCV8186BMN175TAG](#) [NCP715SQ15T2G](#) [MIC5317-3.0YD5-T5](#)
[NCV563SQ18T1G](#) [MIC5317-2.8YD5-T5](#) [NCP715MX30TBG](#) [MIC5317-2.5YD5-T5](#)