

## 1.2A 36V Step Down High Brightness LED Driver

November 2019

Rev. 1.2.1

### GENERAL DESCRIPTION

The XRP7613 is a non-synchronous step down converter with integrated FET optimized to drive high power LEDs at up to 1.2A of continuous current. A wide 7.0V to 36V input voltage range allows for single supply operations from industry standard 12V, 18V or 24V power rails.

Based on a hysteretic PFM control scheme, the XRP7613 can operate at switching frequency of up to 1MHz and allows for small external components selection while providing very fast transient response and achieving excellent efficiency. The output current is programmable from 150mA to 1.2A through an external sense resistor.

Output current dimming is supported through an analog signal or PWM logic signal at up to 40kHz. A dynamic LED current thermal control further enhances the reliability of the end application by linearly reducing the LED current as temperature raises.

An open LED, LED short circuit, over temperature and under voltage lock out protection insures safe operations under abnormal operating conditions.

The XRP7613 is offered in RoHS compliant, "green"/halogen free 8-pin Exposed Pad SOIC package.

### APPLICATIONS

- **General Lighting and Displays**
- **Architectural and Accent Lighting**
- **Medical and Industrial Instrumentation**
- **Video Projectors**

### FEATURES

- **1.2A Continuous Output LED Current**
  - 150mA to 1.2A Programmable Range
- **7V to 36V Single Rail Input Voltage**
- **PWM & Analog Dimming Capability**
  - Up to 40kHz Frequency
- **LED Current Foldback Thermal Control**
  - Selectable Automatic Linear Dimming of LED Current with temperature
- **Shutdown Control**
- **Built-in Soft Start**
- **Open LED, LED Short Circuit and Over Temperature Protections**
- **RoHS Compliant "Green"/Halogen Free 8-pin Exposed Pad SOIC Package**

### TYPICAL APPLICATION DIAGRAM

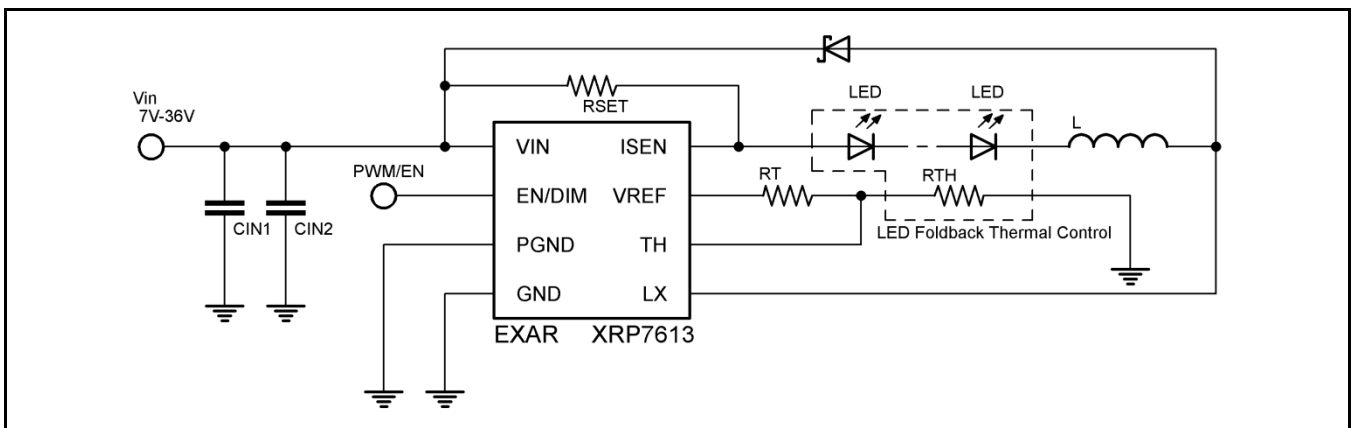

Fig. 1: XRP7613 Application Diagrams

## 1.2A 36V Step Down High Brightness LED Driver

### ABSOLUTE MAXIMUM RATINGS

These are stress ratings only and functional operation of the device at these ratings or any other above those indicated in the operation sections of the specifications below is not implied. Exposure to absolute maximum rating conditions for extended periods of time may affect reliability.

Input Voltage $V_{IN}$ .....	40V
ISEN Voltage .....	( $V_{IN}+0.3V$ ) to ( $V_{IN}-5V$ )
EN/DIM Voltage.....	-0.3V to 5V
Junction Temperature .....	150°C
Storage Temperature.....	-65°C to 150°C
Lead Temperature (Soldering, 10 sec) .....	260°C
ESD Rating (HBM - Human Body Model) .....	
All pins.....	2kV

### OPERATING RATINGS

Input Voltage Range $V_{IN}$ .....	7V-36V
Operating Temperature Range.....	-40°C to 85°C
Thermal Resistance .....	
$\theta_{JA}^1$ .....	60°C/W
$\theta_{JC}^1$ .....	15°C/W

Note 1: Package is placed on 2-layer PCB with 2 ounces copper and 2 square inch, connected with 8 vias.

### ELECTRICAL SPECIFICATIONS

Specifications with standard type are for an Operating Ambient Temperature of  $T_J = T_A = 25^\circ\text{C}$  only; limits applying over the full Operating Ambient Temperature range are denoted by a “•”. Minimum and Maximum limits are guaranteed through test, design, or statistical correlation. Typical values represent the most likely parametric norm at  $T_A = 25^\circ\text{C}$ , and are provided for reference purposes only. Unless otherwise indicated,  $V_{IN} = 12V$ ,  $L=47\mu\text{H}$ , 1 x LED and  $I_{LED}=330\text{mA}$  and  $T_A= 25^\circ\text{C}$ .

Parameter	Min.	Typ.	Max.	Units	Conditions
Quiescent Current		0.5	1	mA	Output switching EN/DIM floating, $f=250\text{kHz}$
		35	45	$\mu\text{A}$	Output not switching EN/DIM<0.2V
Mean Current Sense Threshold Voltage	95	100	105	mV	Measured on ISEN pin with respect to $V_{IN}$ .
ISEN Threshold Hysteresis	-15		+15	%	
$I_{LED}$ Output Current Range	150		1200	mA	$V_{IN}=12V$
Efficiency		93		%	$V_{IN}=12V$ , $V_{OUT}=7.2V$ , $L=47\mu\text{F}$ , $I_{LED}=330\text{mA}$
Switch On Resistance $R_{DS(ON)}$		0.5		$\Omega$	N-MOSFET (PVDD2=5V)
Switch Leakage Current		1	5	$\mu\text{A}$	
Operating Frequency $f_{SW}$		350		kHz	EN/DIM floating, $L=47\mu\text{F}$ , $I_{LED}=330\text{mA}$ , 1xLED
Minimum Switch On Time		180		ns	
Minimum Switch OFF Time		280		ns	
VREF Voltage	2.46	2.5	2.54	V	
VREF Output Current			250	$\mu\text{A}$	
Recommended Duty Cycle Range at $f_{SW\_MAX}$	30		70	%	
Under Voltage Lock Out Threshold		6		V	$V_{IN}$ Rising
		5.5			$V_{IN}$ Falling
Maximum Dimming Frequency			40	kHz	
EN/DIM Input Level Logic High	1.3			V	
EN/DIM Input Level Analog	0.4		1.25	V	
EN/DIM Input Level Logic Low			0.2	V	
EN/DIM Shutdown Delay		16		ms	
EN/DIM Pull Up Current		3.7		$\mu\text{A}$	
Thermal Shutdown Temperature		150		$^\circ\text{C}$	
Thermal Shutdown Hysteresis		30		$^\circ\text{C}$	
Thermal Regulation Input Level		0.4		V	$R_I=10\text{k}\Omega$ , $R_{TH}=1.91\text{k}\Omega$
		0.28			$R_I=10\text{k}\Omega$ , $R_{TH}=1.265\text{k}\Omega$



**1.2A 36V Step Down High Brightness LED Driver**
**PIN DESCRIPTION**

Name	Pin	Description
PGND	1	Power ground pin.
VIN	2	Power supply input pin. Place an input decoupling capacitor as close as possible to this pin.
ISEN	3	LED current setting pin. Connect resistor RSET from this pin to VIN (pin 2) to define nominal average LED current.
EN/DIM	4	Dimming and Enable pin. For automatic startup, leave pin floating.
TH	5	LED temperature protection sense input. Connect temperature thermal sense resistors to turn off output current above a preset temperature threshold.
VREF	6	Reference Voltage for thermal protection.
GND	7	Ground pin.
LX	8	Connect to the output inductor.
GND	Exposed Pad	Power ground pin.

**ORDERING INFORMATION<sup>(1)</sup>**

Part Number	Ambient Temperature Range	Package	Packaging Method	Lead-Free <sup>(2)</sup>
XRP7613IDBTR-F	$-40^{\circ}\text{C} \leq T_A \leq +125^{\circ}\text{C}$	HSOICN-8 Exp. Pad	Tape & Reel	Yes
XRP7613EVB	XRP7613 Evaluation Board			

## NOTE:

1. Refer to [www.maxlinear.com/XRP7613](http://www.maxlinear.com/XRP7613) for most up-to-date Ordering Information.
2. Visit [www.maxlinear.com](http://www.maxlinear.com) for additional information on Environmental Rating.

**1.2A 36V Step Down High Brightness LED Driver**

**TYPICAL PERFORMANCE CHARACTERISTICS**

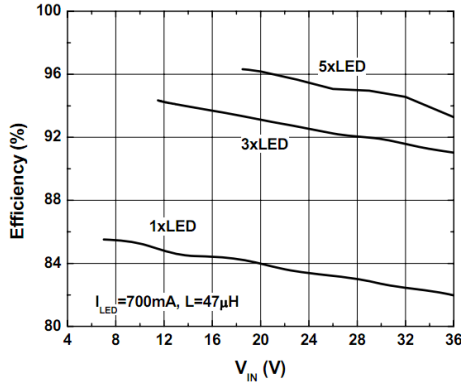

Fig. 4: Efficiency versus Input Voltage

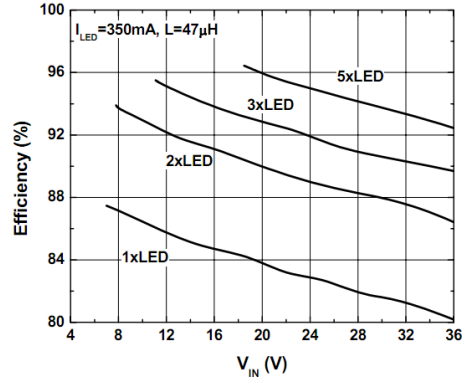

Fig. 5: Efficiency versus Input Voltage

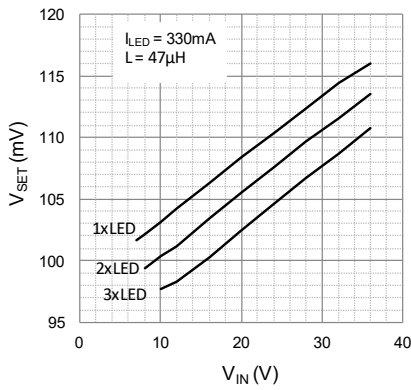

Fig. 6:  $V_{SET}$  versus Input Voltage at  $I_{LED}=330mA$

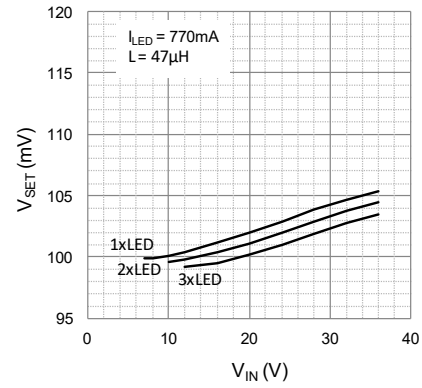

Fig. 7:  $V_{SET}$  versus Input Voltage at  $I_{LED}=770mA$

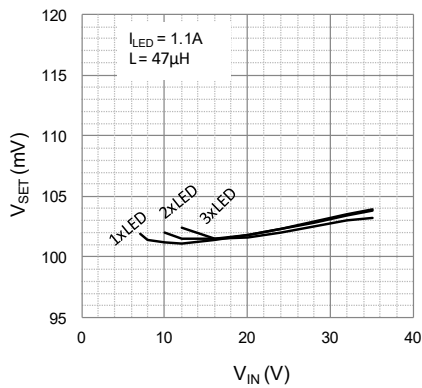

Fig. 8:  $V_{SET}$  versus Input Voltage at  $I_{LED}=1.1A$

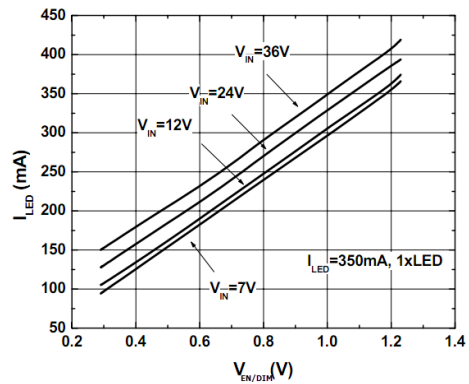

Fig. 9: LED Current versus EN/DIM Voltage

**1.2A 36V Step Down High Brightness LED Driver**

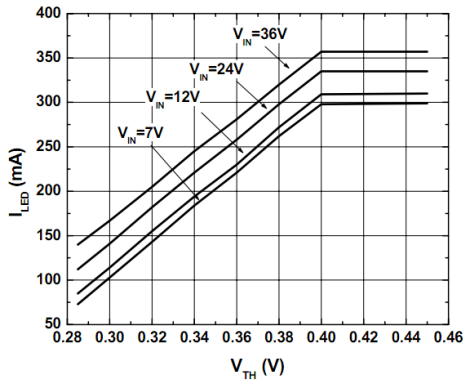

Fig. 10: Thermal Regulation

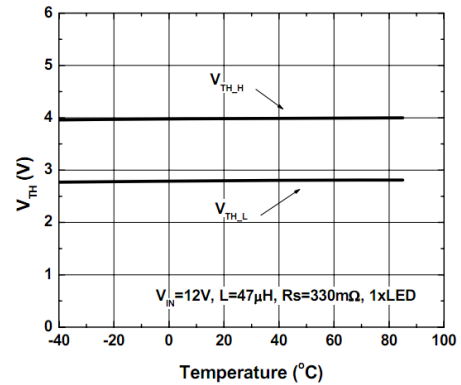

Fig. 11: Thermal Regulation Threshold versus Temperature

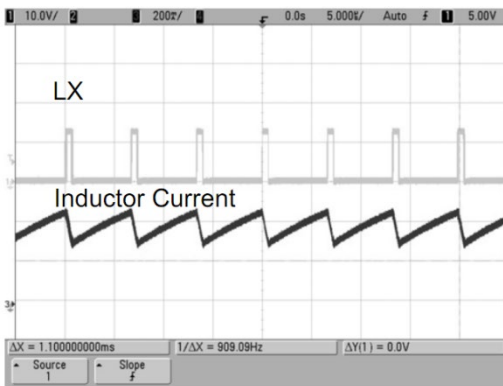

Fig. 12: Switch Waveform  
 $V_{IN}=12V$ ,  $I_{LED}=350mA$ , 3 LEDs

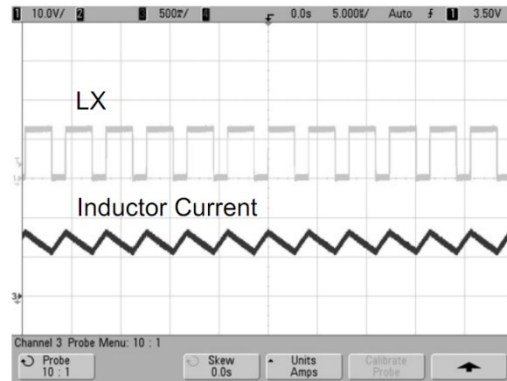

Fig. 13: Switch Waveform  
 $V_{IN}=12V$ ,  $I_{LED}=700mA$ , 1 LED

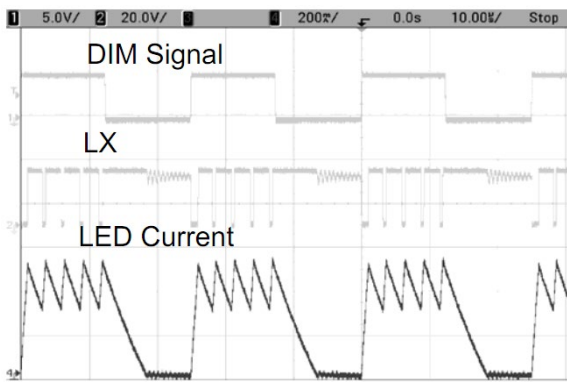

Fig. 14: PWM Dimming  
 $V_{IN}=24V$ , Duty Cycle = 50%,  $f_{PWM}=40kHz$

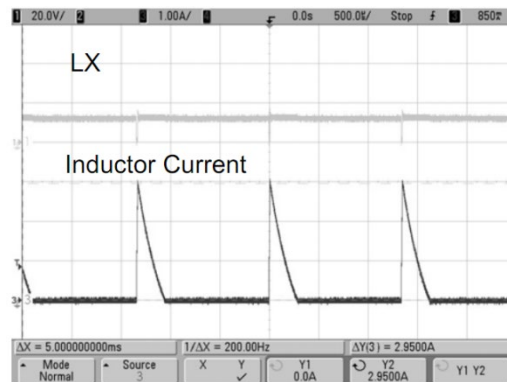

Fig. 15: Short Circuit  
 $V_{IN}=12V$

**1.2A 36V Step Down High Brightness LED Driver**

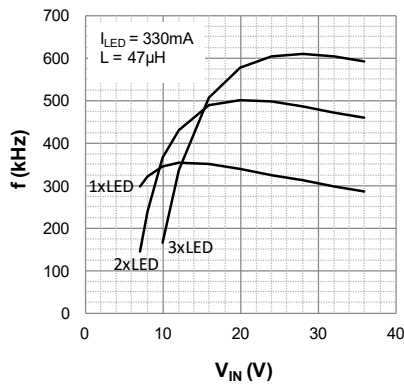

Fig. 16: frequency versus input voltage,  $I_{LED}=330mA$

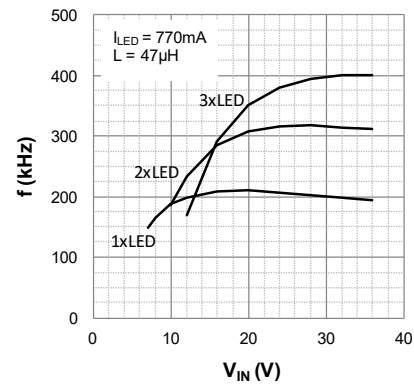

Fig. 17: frequency versus input voltage,  $I_{LED}=770mA$

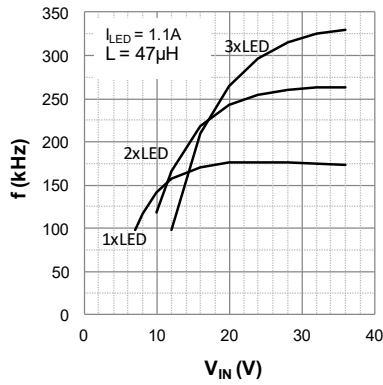

Fig. 18: frequency versus input voltage,  $I_{LED}=1.1A$

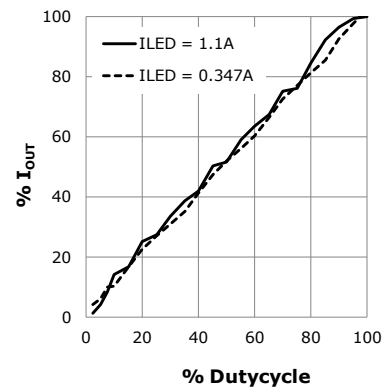

Fig. 19: PWM dimming at 25kHz,  $V_{IN}=24V$ , 3xLED,  $L=47\mu H$

## 1.2A 36V Step Down High Brightness LED Driver

### APPLICATION INFORMATION

#### HYSTERETIC OPERATION

The XRP7613 is a hysteretic step-down LED driver. It uses  $\pm 15\%$  double-ended hysteresis to regulate the average LED current to the value programmed by RSET (refer to figure 1). The  $\pm 15\%$  hysteresis is achieved with resistors R2 and R3 in the block diagram shown in figure 2. Average internal current through R1, R2 and R3 is given by  $I_{INT(AVG)} = 0.1V/R1$ . Note that voltage across RSET must be the same as voltage across R1. Therefore average LED current should be  $I_{LED(AVG)} = 0.1V/R_{SET}$ . During off time FETs N1 and N2 are off. Inductor current  $I_L$  ramps down through the external Schottky diode and voltage at ISEN decreases. This, in turn, causes the  $I_{INT}$  to decrease. When  $I_{INT}$  falls 15% below  $I_{INT(AVG)}$ , comparator is triggered on (note that this should correspond to  $I_{LED}$  falling 15% below  $I_{LED(AVG)}$ ). N1 and N2 turn on and on time commences. N2 shorts R3 and thereby requires a higher  $I_{INT}$  in order to trigger the comparator off. N1 shorts the inductor to ground,  $I_L$  ramps up and voltage at ISEN increases. This causes the  $I_{INT}$  to increase. When  $I_{INT}$  rises 15% above  $I_{INT(AVG)}$ , comparator is triggered off and the cycle repeats.

#### TURN ON AND TURN OFF DELAY

As explained above when  $I_{INT}$  falls 15% below  $I_{INT(AVG)}$ , the comparator is triggered on. However, it takes 280ns (nominal) before N1 turns on and LX transitions from high to low voltage (refer to figure 20). The turn on delay time results in inductor current ripple  $\Delta I_L$  to exceed the -15% hysteresis set by the internal control. Because this delay imposes a lower bound on the N1 off time, it has been called "Minimum Switch OFF Time" in the electrical specifications table.

When  $I_{INT}$  rises 15% above  $I_{INT(AVG)}$ , the comparator is triggered off. There is, however, a delay of 180ns before N1 turns off and LX transitions from low to high voltage. The turn off delay time results in  $\Delta I_L$  exceeding the +15% hysteresis set by the internal control. Because this delay imposes a lower bound on

the N1 on time, it has been called "Minimum Switch ON Time" in the electrical specifications table.

Thus the delay times will cause the switching frequency to be lower than expected because the turn on and turn off time will take longer to complete. Graphs of typical switching frequency versus  $V_{IN}$  for various operating conditions are shown in figures 16-18.

The delay times, under some operating conditions, may force the average current to deviate from  $I_{LED(AVG)} = 0.1V/R_{SET}$  if they cause asymmetric hysteresis. As an example in figure 20 the positive hysteresis is higher than the negative hysteresis and there is a positive offset. Average current is higher than  $0.1V/R_{SET}$ . The effect of delay times on average current has been taken into account by measuring the voltage across RSET for various operating conditions. Graphs of  $V_{SET}$  versus  $V_{IN}$  are shown in (figures 6-8).

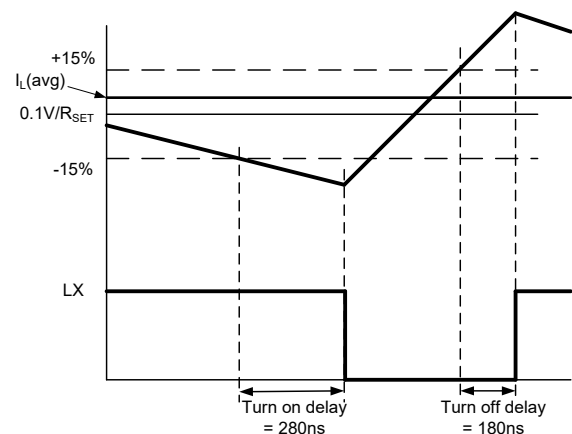

Fig. 20: Effect of Delay Times on Inductor and LED Current Ripple and Average Current

#### SHUTDOWN CONTROL

A shutdown control function is provided through the EN/DIM input pin. Connecting the EN/DIM input pin to ground or to a DC voltage lower than 200mV for longer than 20ms will completely shut down the XRP7613. In this state, the quiescent current is less than 35 $\mu$ A and the internal reference, error amplifier, comparators, and biasing circuitry completely turned off.



## 1.2A 36V Step Down High Brightness LED Driver

### SETTING THE LED CURRENT

The output current  $I_{LED}$  of XRP7613 can be set by the external sense resistor  $R_{SET}$ . The relationship between  $I_{LED}$  and  $R_{SET}$  is

$$R_{SET} = \frac{V_{SET}}{I_{LED}}$$

$V_{SET}$  can be determined from graphs in figures 6-8. As an example for the operating conditions  $I_{LED}=350\text{mA}$ ,  $V_{IN}=24\text{V}$ , 3xLED;  $V_{SET}=105\text{mV}$  from figure 6.

### OPERATING FREQUENCY

The operating frequency of the XRP7613 can be calculated from the following equation

$$f_s = \frac{1}{T_{ON} + T_{OFF}}$$

where  $f_s$  is the operating frequency,  $T_{ON}$  is the switch on time and  $T_{OFF}$  is the switch off time.

The switch on time can be approximated from the following equation

$$T_{ON} = \frac{L \times \Delta I_L}{V_{IN} - V_{LED} - I_{LED} \times (R_{SET} + R_L + R_{DS(ON)})}$$

$$T_{ON(MIN)} > 250\text{ns}$$

The switch off time can be approximated from the following equation

$$T_{OFF} = \frac{L \times \Delta I_L}{V_{LED} + V_D + I_{LED} \times (R_{SET} + R_L)}$$

$$T_{OFF(MIN)} > 350\text{ns}$$

where  $V_{IN}$  is the input voltage

$V_{LED}$  is the total LED forward voltage

$I_{LED}$  is the LED average current

$R_{SET}$  is current sense resistance

$R_L$  is inductor resistance

$R_{DS(ON)}$  is switch on resistance ( $0.5\Omega$  typ.)

$L$  is the inductor value

$\Delta I_L$  is the inductor peak to peak current

$V_D$  is diode forward voltage at the LED average current.

The recommended operating frequency should not exceed 1MHz.

### DIMMING CONTROL

The XRP7613 offers two ways of achieving LED dimming: standard PWM dimming and analog dimming. The EN/DIM input pin is used not only to control the XRP7613 shutdown but also the PWM and analog dimming functions.

If dimming and/or shutdown controls are not required, the EN/DIM pin can be left floating for automatic turn on upon application of proper  $V_{IN}$ .

#### PWM Dimming

A logic-level PWM signal applied to the EN/DIM pin can be used for PWM dimming control of the LEDs. This external signal turns the MOSFET gate drive on and off, thereby modulating the average current delivered to the LED proportional to the duty cycle of the PWM signal. The EN/DIM signal will shutdown the XRP7613 when EN/DIM = L and turn-on the XRP7613 when DIM = H. The DIM signal needs to be greater than 1.3V minimum to turn-on and less than 200mV to fully turn-off the device.

The maximum allowed PWM dimming frequency that can be applied is 40 KHz.

#### Analog Dimming

The average current delivered to the LED, ie the LED brightness, can also be controlled by applying a variable DC voltage signal to the EN/DIM pin.

A DC voltage greater than 1.25V will drive output LED current to 100% of the LED current as set by the external sense resistor  $R_{SET}$  while a voltage lower than 200mV will shutdown the XRP7613. When analog dimming is required, the DC voltage range of EN/DIM should be between 0.4V to 1.25V in order modulating the average current delivered to the LED accordingly.

## 1.2A 36V Step Down High Brightness LED Driver

### PROTECTIONS

#### LED Open Circuit Protection

Upon detection of an open-circuit on any LED connected to the XRP7613, the device will shut down.

#### LED Short Circuit Protection

Upon detecting a short-circuit on any LED connected to the XRP7613, the device will maintain the LED current as set by the external sense resistor  $R_{SET}$ .

#### UVLO Protection

The XRP7613 has an Under Voltage Lock-Out comparator to monitor the Input Voltage  $V_{IN}$ . The  $V_{IN}$  UVLO threshold is set internally: when  $V_{IN}$  pin is greater than 6.0V the XRP7613 is permitted to start up pending the removal of all other faults.

#### LED Thermal Protection

The XRP7613 includes a LED thermal regulation circuit to prevent an over temperature situation on the LED. When the LED temperature rises above a predefined threshold, the XRP7613 will reduce linearly the LED current from its nominal set value.

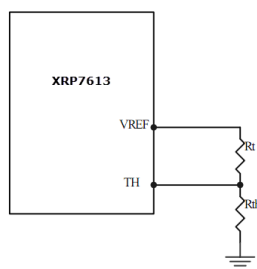

Fig. 21:  $V_{TH}$  Voltage

The XRP7613 continuously monitors the LED temperature by measuring the voltage on its TH pin. The  $V_{TH}$  voltage is created through a resistive network of a negative temperature coefficient (NTC) thermistor  $R_{TH}$  and a fixed resistor  $R_T$  between VREF pin and ground.

By setting  $R_T=10K\Omega$  and using a 103KT1608 thermistor, the voltage on the TH pin will reduce to 0.4V when the LED temperature reaches 70°C. The LED average current will be decreased linearly when  $V_{TH}$  is between 0.4V and 0.28V. If the LED temperature is over 90°C, the voltage on the TH pin will reduce to 0.28V and the LED will be turned off in order to decrease the LED temperature. When the voltage on the TH pin rises to 0.3V, the LED will be turned on again.

If the LED thermal regulation function isn't required, the TH pin should be connected directly to VREF pin to disable this function.

### DIODE SELECTION

Schottky diodes, with their low forward voltage drop and fast reverse recovery, are the ideal choices for any XRP7613 applications. The forward voltage drop of a Schottky diode represents the conduction losses in the diode, while the diode capacitance ( $C_T$  or  $C_D$ ) represents the switching losses. For diode selection, both forward voltage drop and diode capacitance need to be considered. Schottky diodes with higher current ratings usually have lower forward voltage drop and larger diode capacitance, which can cause significant switching losses. A Schottky diode with a 2A current rating is adequate for most XRP7613 applications.

### INPUT CAPACITOR SELECTION

Ceramic capacitors with their low ESR values and small size are ideal for the XRP7613 applications. When selecting an input capacitor, a low ESR capacitor is required to minimize the noise at the device input. It may be necessary to add an extra small value ceramic type capacitor in parallel with the input capacitor to prevent any possible ringing.

### INDUCTOR SELECTION

Recommended inductor values for the XRP7613 are in the range of 22 $\mu$ H to 68  $\mu$ H. The inductor selected should have low core losses and low DCR.

## 1.2A 36V Step Down High Brightness LED Driver

### LAYOUT CONSIDERATION

For proper operations of XRP7613, the following guidelines should be followed.

- 1.The input capacitor should be placed as close as possible to the  $V_{IN}$  pin in order to reduce the input voltage ripple and noise.
- 2.The inductor, internal power switch, Schottky diode, output capacitor and the LEDs should be kept as close as possible.
- 3.PCB traces with large current should be kept short and wide.

5.Effect from noise can be reduced by placing the XRP7613 GND pin as close as possible to the ground pin of the input bypass capacitor.

6.The ISEN pin and VIN pin should be connected to the sense resistor directly. Traces should be routed away from any potential sources.

7.The VREF pin and TH pin should be connected to the LED thermal sense resistors directly. Traces should be routed away from any potential sources.

### TYPICAL APPLICATION CIRCUITS

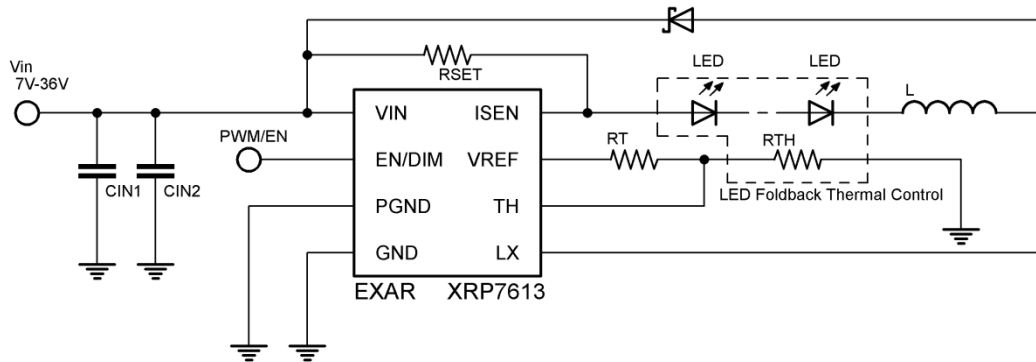
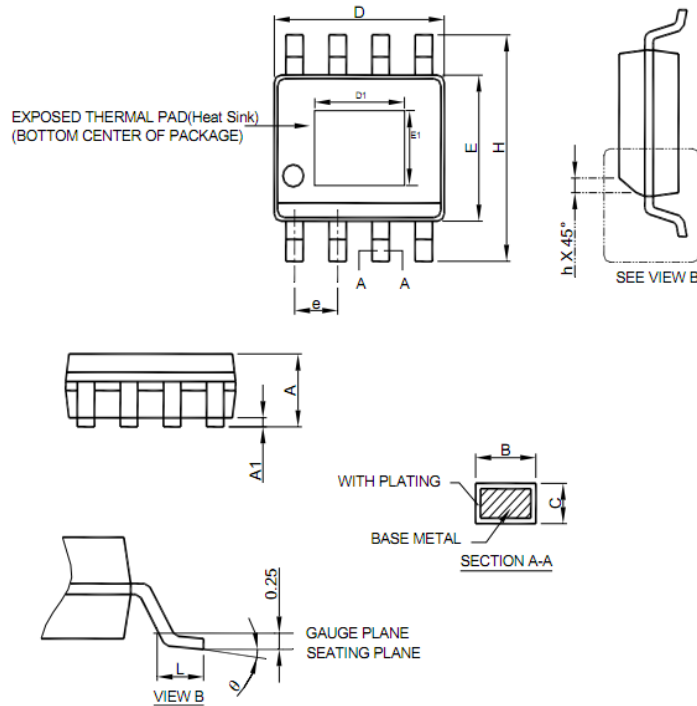

Fig. 22: Typical Application Diagram

**MECHANICAL DIMENSIONS**
**8-PIN EXPOSED PAD SOIC**

SOP-8 Exposed Pad(Heat Sink)		
MILLIMETERS		
SYMBOL	MIN.	MAX.
A	1.35	1.75
A1	0.00	0.15
B	0.31	0.51
C	0.17	0.25
D	4.80	5.00
E	3.80	4.00
e	1.27 BSC	
H	5.80	6.20
h	0.25	0.50
L	0.40	1.27
q	0°	8°
D1	1.5	3.5
E1	1.0	2.55

- Note :
1. Refer to JEDEC MS-012E.
  2. Dimension "D" does not include mold flash, protrusions or gate burrs. Mold flash, protrusion or gate burrs shall not exceed 6 mil per side .
  3. Dimension "E" does not include inter-lead flash or protrusions.
  4. Controlling dimension is millimeter, converted inch dimensions are not necessarily exact.

---

**REVISION HISTORY**

Revision	Date	Description
1.0.0	11/09/2012	Initial Release of Datasheet
1.1.0	11/26/2012	Corrected typographical error L=47 $\mu$ H in Electrical Specification conditions.
1.2.0	12/10/2012	Added explanation to 'hysteretic operation' and 'turn on and turn off delay time'.
1.2.1	11/01/2019	Updated to MaxLinear logo. Updated Ordering Information.

**CORPORATE HEADQUARTERS:**

5966 La Place Court

Suite 100

Carlsbad, CA 92008

Tel.: +1 (760) 692-0711

Fax: +1 (760) 444-8598

[www.maxlinear.com](http://www.maxlinear.com)

The content of this document is furnished for informational use only, is subject to change without notice, and should not be construed as a commitment by Maxlinear, Inc. Maxlinear, Inc. Assumes no responsibility or liability for any errors or inaccuracies that may appear in the informational content contained in this guide. Complying with all applicable copyright laws is the responsibility of the user. Without limiting the rights under copyright, no part of this document may be reproduced into, stored in, or introduced into a retrieval system, or transmitted in any form or by any means (electronic, mechanical, photocopying, recording, or otherwise), or for any purpose, without the express written permission of Maxlinear, Inc.

Maxlinear, Inc. Does not recommend the use of any of its products in life support applications where the failure or malfunction of the product can reasonably be expected to cause failure of the life support system or to significantly affect its safety or effectiveness. Products are not authorized for use in such applications unless Maxlinear, Inc. Receives, in writing, assurances to its satisfaction that: (a) the risk of injury or damage has been minimized; (b) the user assumes all such risks; (c) potential liability of Maxlinear, Inc. Is adequately protected under the circumstances.

Maxlinear, Inc. May have patents, patent applications, trademarks, copyrights, or other intellectual property rights covering subject matter in this document. Except as expressly provided in any written license agreement from Maxlinear, Inc., the furnishing of this document does not give you any license to these patents, trademarks, copyrights, or other intellectual property.

Maxlinear, the Maxlinear logo, and any Maxlinear trademarks, MxL, Full-Spectrum Capture, FSC, G.now, AirPHY and the Maxlinear logo are all on the products sold, are all trademarks of Maxlinear, Inc. or one of Maxlinear's subsidiaries in the U.S.A. and other countries. All rights reserved. Other company trademarks and product names appearing herein are the property of their respective owners.

© 2012 - 2019 Maxlinear, Inc. All rights reserved.

## X-ON Electronics

Largest Supplier of Electrical and Electronic Components

*Click to view similar products for [LED Lighting Development Tools](#) category:*

*Click to view products by [MaxLinear](#) manufacturer:*

Other Similar products are found below :

[MIC2870YFT EV](#) [TDGL014](#) [ISL97682IRTZEVALZ](#) [EA6358NH](#) [TPS92315EVM-516](#) [STEVAL-LLL006V1](#) [IS31LT3948-GRLS4-EB](#)  
[PIM526](#) [PIM527](#) [MAX6946EVKIT+](#) [MAX20070EVKIT#](#) [MAX20090BEVKIT#](#) [PIM498](#) [AP8800EV1](#) [AP8802HEV2](#) [ZXLD1370/1EV4](#)  
[1216.1013](#) [1270](#) [1271.2004](#) [1272.1030](#) [1273.1010](#) [1278.1010](#) [1279.1002](#) [1279.1001](#) [1282.1000](#) [1293.1900](#) [1293.1800](#) [1293.1700](#)  
[1293.1500](#) [1293.1100](#) [1282.1400](#) [1282.1100](#) [1293.1200](#) [1282.1200](#) [1293.1000](#) [1282.6000](#) [1296.2012](#) [MIKROE-2520](#) [1721](#) [1762](#) [PIR-](#)  
[GEVB](#) [STEVAL-ILL056V1](#) [ADM00767](#) [STEVAL-ILL080V1](#) [DC1224A](#) [DC1160A](#) [DC1274A](#) [STEVAL-ILL070V4](#) [2314786-1](#) [BOB-](#)  
[13884](#)