



A New Direction in Mixed-Signal

January 2014

XRP9711EVB-DEMO-1

Quad Channel Digital PWM/PFM Demo Board Programmable Power Management System

Rev. 1.0.0

GENERAL DESCRIPTION

The XRP779711EVB-DEMO-1 board is a complete, four channel power system. It provides 1.5V, 1.2V 1.8V and 2.5V at maximum currents of 10A, 10A, 6A and 6A respectively. The 1.5V and 1.2V supplies can be adjusted in 2.5mV increments, the 1.8V and 2.5V supplies in 5mV increments. The order and ramp rates for each supply can be programmed to accommodate any sequencing requirement. All power supply operations can be controlled over an I²C interface. Faults, output voltages and currents can also be monitored. Two GPIO and three PSIO signals are available and can be programmed to provide a variety of functions. Unused GPIO/PSIO pins can be programmed as I/O expansion for a microcontroller. The board is supported by PowerArchitect™ 5.1 and plugs directly onto the interposer board acting as an interface to Arduino controller.

EVALUATION BOARD MANUAL

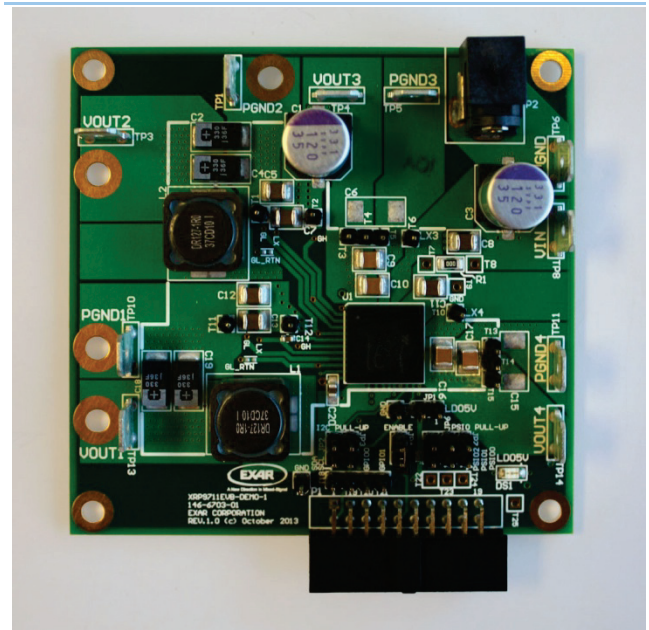

XRP9711EVB-DEMO-1

FEATURES

- **XRP9711 Programmable Power Module**
 - Channels 1 and 2 driving external power stages
 - Channel 3 and 4 internal converters
- **4 Channel Power System**
- **Wide Input Voltage Range: 5.5V-22V**
- **I²C Interface**
 - Programming
 - Monitoring
 - Control
- **Arduino GPIO, PSIO and ENABLE control**



A New Direction in Mixed-Signal

January 2014

XRP9711EVB-DEMO-1

Quad Channel Digital PWM/PFM Demo Board

Programmable Power Management System

Rev. 1.0.0

EVALUATION BOARD SCHEMATICS

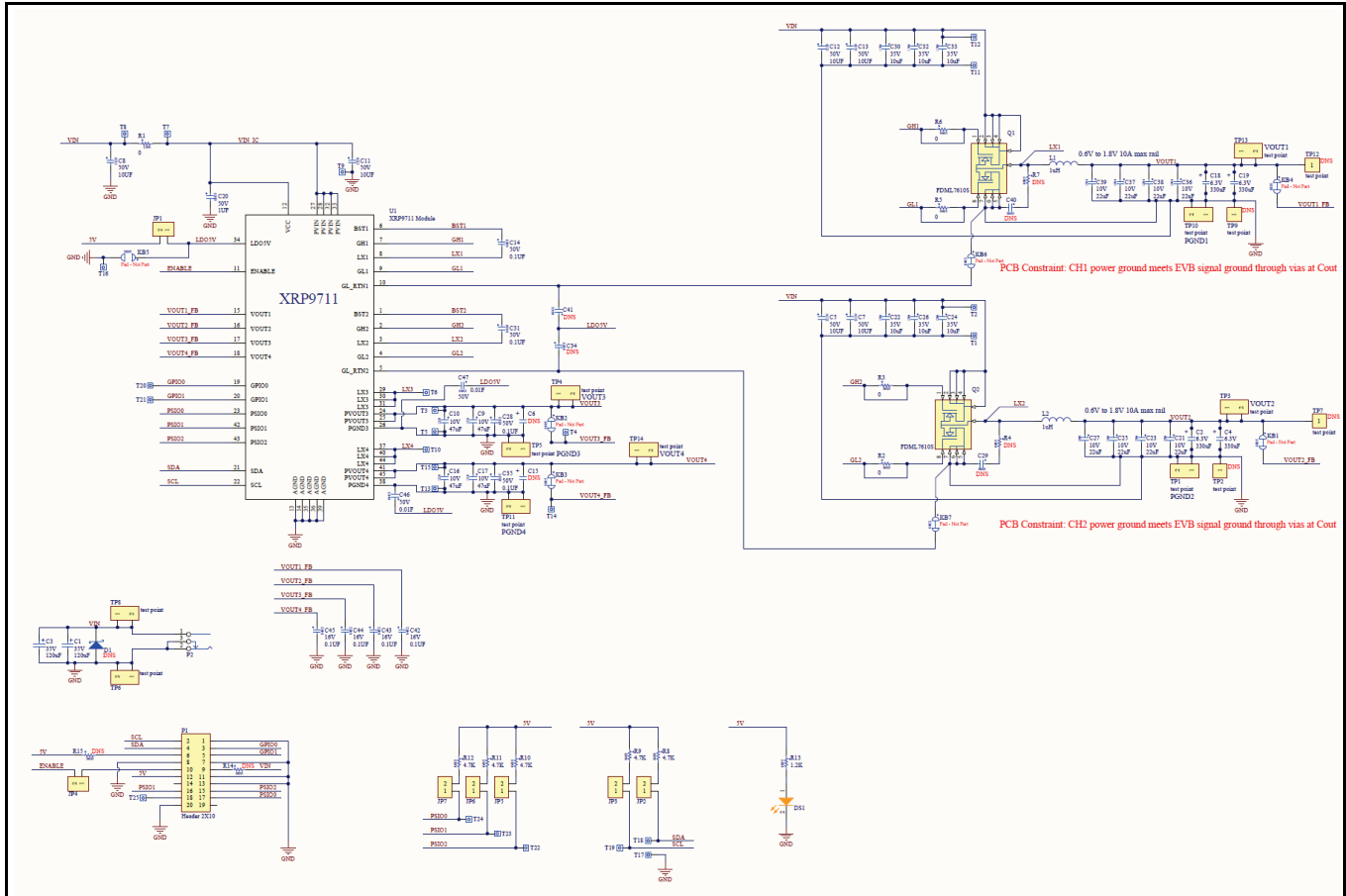

Figure 1 XRP9711 Evaluation Board Schematics



A New Direction in Mixed-Signal

XRP9711EVB-DEMO-1

Quad Channel Digital PWM/PFM Demo Board Programmable Power Management System

PIN DESCRIPTION

Pin #	Name	Description
1	BST2	Boost pin. High side driver supply input.
2	GH2	High Side Gate Drive Out. Connect directly to the gate of an external N-channel MOSFET.
3	LX2	Switch Node. Return for the high-side gate driver. Connect directly to the drain of the lower FET. Also used to measure voltage drop across bottom MOSFETs
4	GL2	Low Side Gate Drive Out. Connect directly to the gate of an external N-channel MOSFET.
5	GL_RT2	Low Side Gate Drive Return. This should be routed as a differential trace with GL. Connect to the source of the low side MOSFET.
6	BST1	Boost pin. High side driver supply input.
7	GH1	High Side Gate Drive Out. Connect directly to the gate of an external N-channel MOSFET.
8	LX1	Switch Node. Return for the high-side gate driver. Connect directly to the drain of the lower FET. Also used to measure voltage drop across bottom MOSFETs
9	GL1	Low Side Gate Drive Out. Connect directly to the gate of an external N-channel MOSFET.
10	GL_RT1	Low Side Gate Drive Return. This should be routed as a differential trace with GL. Connect to the source of the low side MOSFET.
11	ENABLE	Enable. If ENABLE is pulled high or allowed to float high, the chip is powered up. The pin must be held low for the XRP9711 to be placed into shutdown.
12	VCC	Controller Supply Voltage. Place a decoupling capacitor close to the controller IC. This input is used in UVLO fault generation.
13	AGND	Analog Ground. This is the small signal ground connection.
14	AGND	Analog Ground. This is the small signal ground connection.
15	VOU1	Feedback Pin. Connect to the output of the corresponding power stage
16	VOU2	Feedback Pin. Connect to the output of the corresponding power stage
17	VOU3	Feedback Pin. Connect to the output of the corresponding power stage
18	VOU4	Feedback Pin. Connect to the output of the corresponding power stage
19	GPIO0	I/O Logic Signal. Can be configured as input or output.
20	GPIO1	I/O Logic Signal. Can be configured as input or output.
21	SDA	I²C Data. SMBus/I ² C serial interface communication.
22	SCL	I²C Clock. SMBus/I ² C serial interface communication.
23	PSIO0	I/O Logic Signal, HV. Open drain, high voltage compliant. Can be configured as input or output.
24	PVOUT3	Channel Output Power. Output voltage for the internal channel.
25	PVOUT3	Channel Output Power. Output voltage for the internal channel.
26	PGND3	Channel Output Ground. Output ground for the internal channel.
27	PVIN	Channel Input Power. Internally connected to drain of upper switching MOSFET
28	PVIN	Channel Input Power. Internally connected to drain of upper switching MOSFET
29	LX3	Switch Node. Switch node of the internal channel.
30	LX3	Switch Node. Switch node of the internal channel.
31	LX3	Switch Node. Switch node of the internal channel.
32	PVIN	Channel Input Power. Internally connected to drain of upper switching MOSFET
33	PVIN	Channel Input Power. Internally connected to drain of upper switching MOSFET
34	LDO5	5V LDO Output. Used internally for power and may also be used for external power. LDO that can remain active while the rest of the IC is in standby mode.
35	AGND	Analog Ground. This is the small signal ground connection.
36	AGND	Analog Ground. This is the small signal ground connection.
37	LX4	Switch Node. Switch node of the internal channel.
38	PGND4	Channel Output Ground. Output ground for the internal channel.
39	AGND	Analog Ground. This is the small signal ground connection.



A New Direction in Mixed-Signal

XRP9711EVB-DEMO-1

Quad Channel Digital PWM/PFM Demo Board Programmable Power Management System

Pin #	Name	Description
40	LX4	Switch Node. Switch node of the internal channel.
41	PVOUT4	Channel Output Power. Output voltage for the internal channel.
42	PSIO1	I/O Logic Signal, HV. Open drain, high voltage compliant. Can be configured as input or output.
43	PSIO2	I/O Logic Signal, HV. Open drain, high voltage compliant. Can be configured as input or output.
44	LX4	Switch Node. Switch node of the internal channel.
45	PVOUT4	Channel Output Power. Output voltage for the internal channel.

ORDERING INFORMATION

Refer to XRP9711's datasheet and/or www.exar.com for exact and up to date ordering information.

USING THE EVALUATION BOARD

INPUT VOLTAGE RANGE

The input voltage range of XRP9711EVB-DEMO-1 board is from 5.5V to 22V. The power components have been optimized for a 12V input rail. When running the board at an input voltage other than 12V, use PowerArchitect™ 5.1 (PA5.1) to evaluate the system performance.

I²C INTERFACE

The XRP9711 programmable power module employs a standard I²C interface. Although the I²C signals can be pulled up to LDO5 on board by means of installing jumpers at the locations JP1, JP2 and JP3, the I²C bus signals are pulled up on the controller interface board by default (refer to Appendix – jumpers installed shorting pins 2 and 3 together at the locations JP6 and JP7).

OPERATING THE EVALUATION BOARD

The XRP9711EVB-DEMO-1 is designed to be powered from either an AC/DC wall wart (the output voltage must be in the range of 5.5V to 22V) connected to the barrel connector or a test bench DC power supply (the voltage must be in the range of 5.5V to 22V) connected to the V_{IN} connectors.

BRING UP PROCEDURE

Plug the XRP9711EVB-DEMO-1 evaluation board to the controller interface board as shown below.

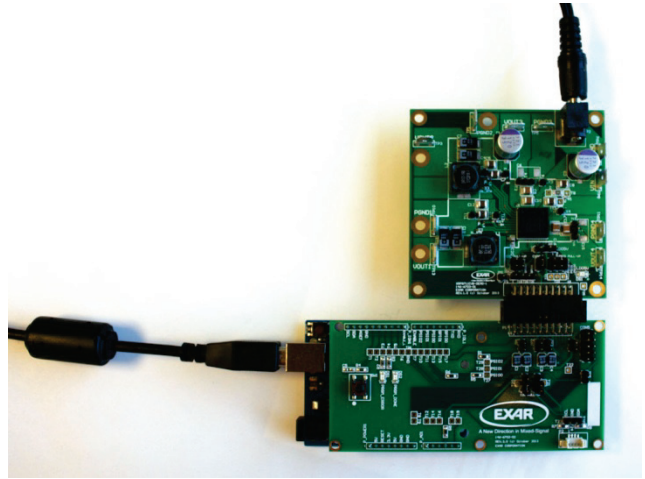

Load the PowerArchitect™ 5.1 software and run it.

After selecting the proper family (Modules) and the device (XRP9711), select the “Get Started with the EVB-DEMO-1” option when prompted as shown below.

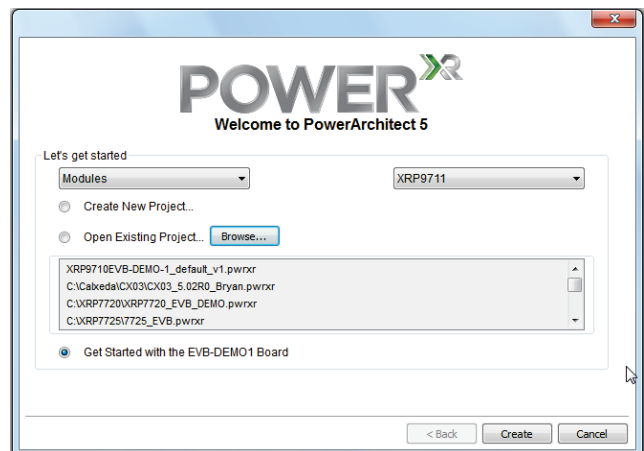

When done, click “Create”. PA 5.1 will load the default XRP9711EVB-DEMO-1 configuration automatically.

Apply power to the board. Please refer to the sections above on how to properly supply power to the board and what voltage range to use.

Turn on the Power supply.

Use USB cable to connect the computer (type A) and the Arduino controller board (type B).

Go to the Tools tab in PA 5.1 and select Boards. The software will identify communication ports where it found the Arduino controller board. Select the port.

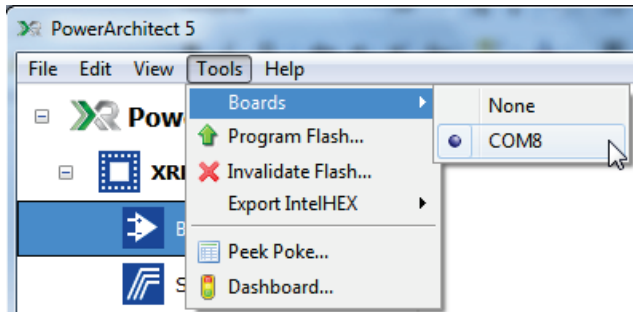

PA 5.1 is now communicating with the Arduino controller board which is indicated in the lower left corner.

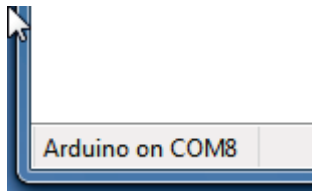

Programming the Configuration onto XRP9711

To program a configuration go to the Tools tab in PA 5.1 and select Program Flash.

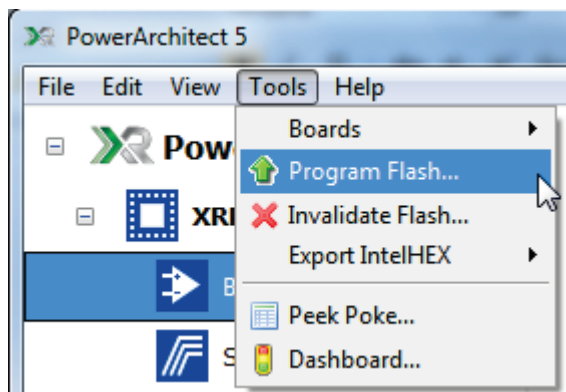

The program Flash window will appear.

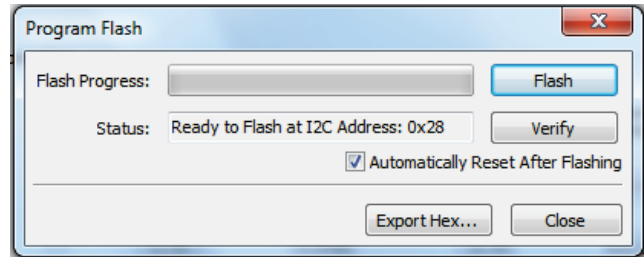

Click the Flash button.

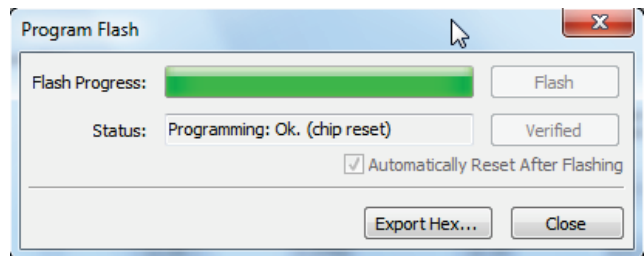

PA 5.1 will go through the process of loading configuration in the flash. Once it has successfully completed the flash, it will report the outcome as seen above and reset the device if "Automatically Reset After Flashing" box checked (default option).

Close the window.

Note that XRP9711EVB-DEMO-1 boards will be pre-loaded with the default configuration.

Regulation

To enable channel regulation go to the Tools tab in PA 5.1 and select Dashboard.

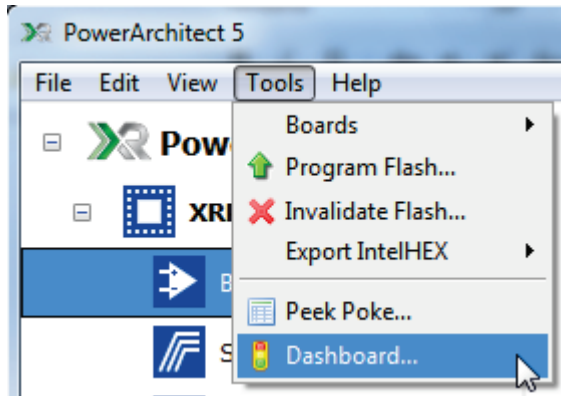

In Dashboard turn Group 1 and Group 2 on. The configuration groups the channels 1 and 2 into the group 1, and the channels 3 and 4 into the group 2. The channels are now in regulation as indicated by V_{OUT} readings as well as the in-regulation indicators.

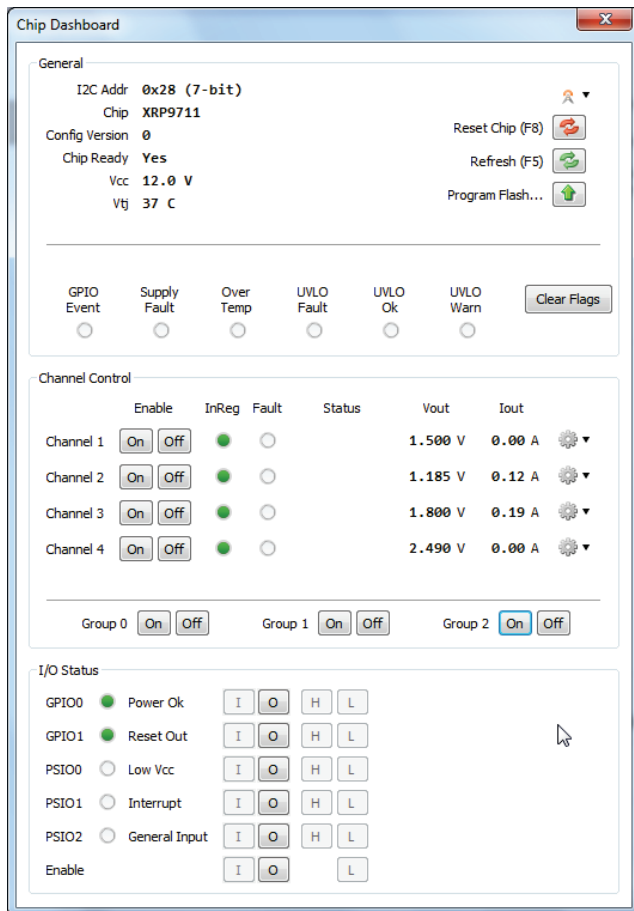

Channels can be turned on individually if desired.

GPIO and PISO interface

The GPIOs, PSIOs and ENABLE can be controlled from the Arduino controller dynamically in the dashboard.

ENABLE signal is connected to the Arduino controller board by default (JP4 header is shorted). Arduino drives the ENABLE pin low to place XRP9711 into the shutdown mode. It releases the ENABLE pin to enable the device. If leaving the ENABLE pin floating is desired, the jumper at JP4 shall be removed.

The PSIOs are not pulled up on XRP9711EVB-DEMO-1 by default. There is a loading option to pull PSIOs up to LDO5 if desired. To do this, one will need to short JP1, JP5, JP6 and JP7 headers by means of installing jumpers.

EVALUATION BOARD CONNECTIONS

The following picture illustrates how V_{IN} supplied from a test bench DC power supply and instruments attached to the outputs would be connected to the XRP9711EVB-DEMO-1 board.

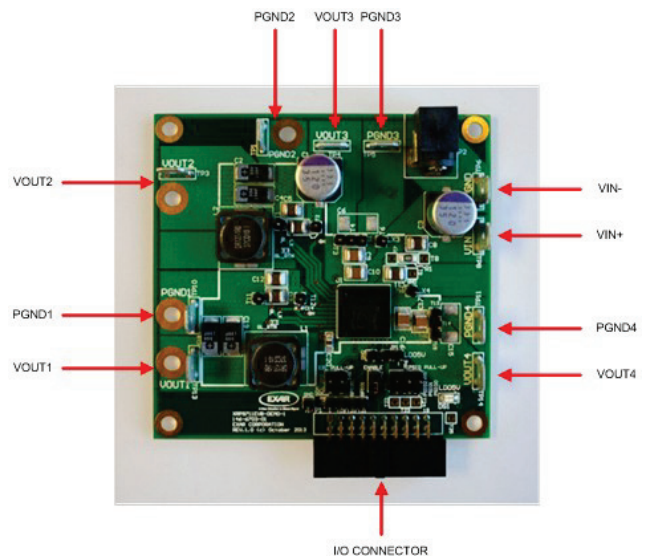

C

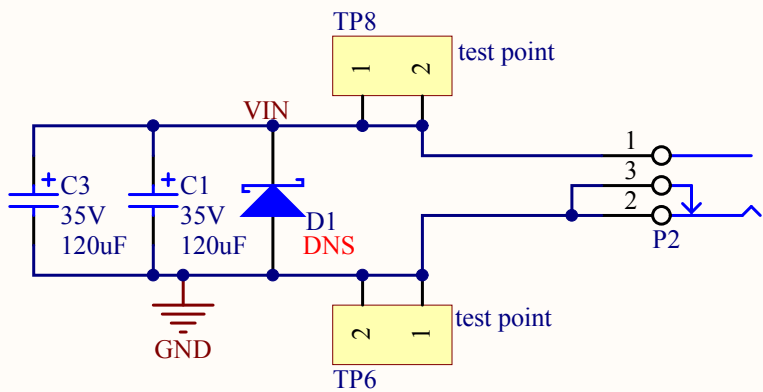

VOUT1 FB

VOUT2 FB

VOUT3 FB

VOUT4 FB

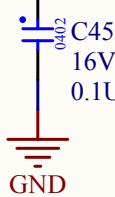

D

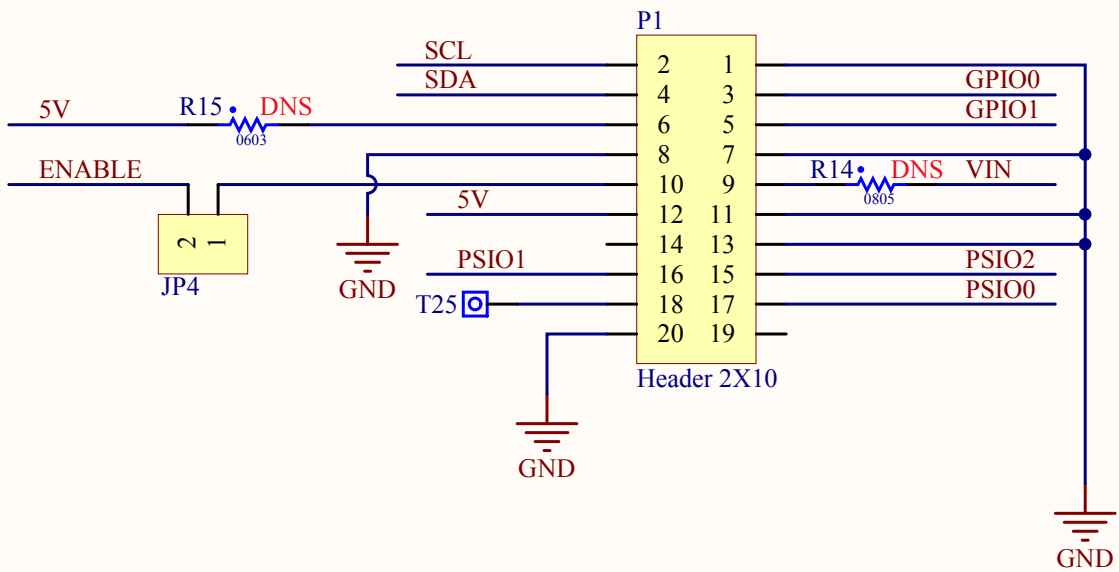

BILL OF MATERIAL

Ref.	Qty	Manufacturer	Part Number	Size	Component
	1	Exar Corporation	146-6703-01	3.15x3.05in	PCB
U1	1	Exar Corporation	XRP9711	12x12mm LGA	Dual 6A Programmable Power Module
Q1,Q2	2	Fairchild	FDML7610S	MLP 3x4.5	Dual N-Channel Power Trench MOSFET
DS1	1	Würth Elektronik	150120AS75000	1206	SMD Amber Chip LED
L1,L2	2	Cooper Bussmann	DR127-1R0-R	12.5x12.5mm	Inductor 1 μ H, 3m Ω , 15.5A
C1,C3	2	Panasonic/Sanyo	35SVPF120M	F12	OSCON Capacitor 120 μ F, 35V
C2, C4, C18, C19	4	Panasonic/Sanyo	6TPF330M9L	7343 D3L	POSCAP Capacitor 330 μ F, 6.3V, 9m Ω
C5, C7, C8, C11, C12, C13	6	Murata Corporation	GRM32ER71H106KA12L	1210	Ceramic Capacitor 10 μ F, 50V, X7R
C9, C10, C16, C17	4	Murata Corporation	GRM32ER71A476KE15L	1210	Ceramic Capacitor 47 μ F, 10V, X7R
C14, C28, C31, C35	4	Murata Corporation	GRM188R71H104KA93D	0603	Ceramic Capacitor 0.1 μ F, 50V, X7R
C20	1	Murata Corporation	GRM21BR71H105KA12L	0805	Ceramic Capacitor 1 μ F, 50V, X7R
C21, C23, C25, C27, C36, C37, C38, C39	8	Murata Corporation	GRM31CR71A226KE15L	1206	Ceramic Capacitor 22 μ F, 10V, X7R
C22, C24, C26, C30, C32, C33	6	TDK Corporation	C3216X7R1V106K160AC	1206	Ceramic Capacitor 10 μ F, 35V, X7R
C42, C43, C44, C45	4	Murata Corporation	GRM155R71C104KA88D	0402	Ceramic Capacitor 0.1 μ F, 16V, X7R
C46, C47	2	Murata Corporation	GRM155R71H103KA88D	0402	Ceramic Capacitor 0.01 μ F, 50V, X7R
R1	1	Vishay Dale	CRCW12060000Z0EAHP	1206	RES 0 Ω , 1/2W, SMD
R8, R9, R10, R11, R12	5	Panasonic	ERJ-3EKF4701V	0603	RES 4.7k Ω , 1/10W, 5%, SMD
R13	1	Panasonic	ERJ-6GEYJ122V	0805	RES 1.2k Ω , 1/8W, 5%, SMD
JP1, JP2, JP3, JP4, JP5, JP6, JP7	7	Würth Elektronik	61300211121	0.20x0.10in	Connector, Male Header, 2 Positions, 100mil Spacing, Vertical, TH



A New Direction in Mixed-Signal

XRP9711EVB-DEMO-1

Quad Channel Digital PWM/PFM Demo Board Programmable Power Management System

Ref.	Qty	Manufacturer	Part Number	Size	Component
P1	1	Sullins Connector Solutions	SFH11-PBPC-D10-RA-BK	1.20x0.55in	Connector, Female Header, 20 Positions, 100mil Spacing, RA, TH
P2	1	Switchcraft	RAPC722X	0.60x0.40in	Connector, Power Jack Mini R/A, T/H
T1, T2, T3, T4, T5, T6, T10, T11, T12, T13, T14, T15, T16, T17, T18, T19, T20, T21	18	Würth Elektronik	61300111121	0.10x0.10in	Square Test Posts, TH
TP1, TP3, TP4, TP5, TP6, TP8, TP10, TP11, TP13, TP14	10	Würth Elektronik	7471287	0.32x0.10in	Mounting Tabs

EVALUATION BOARD LAYOUT

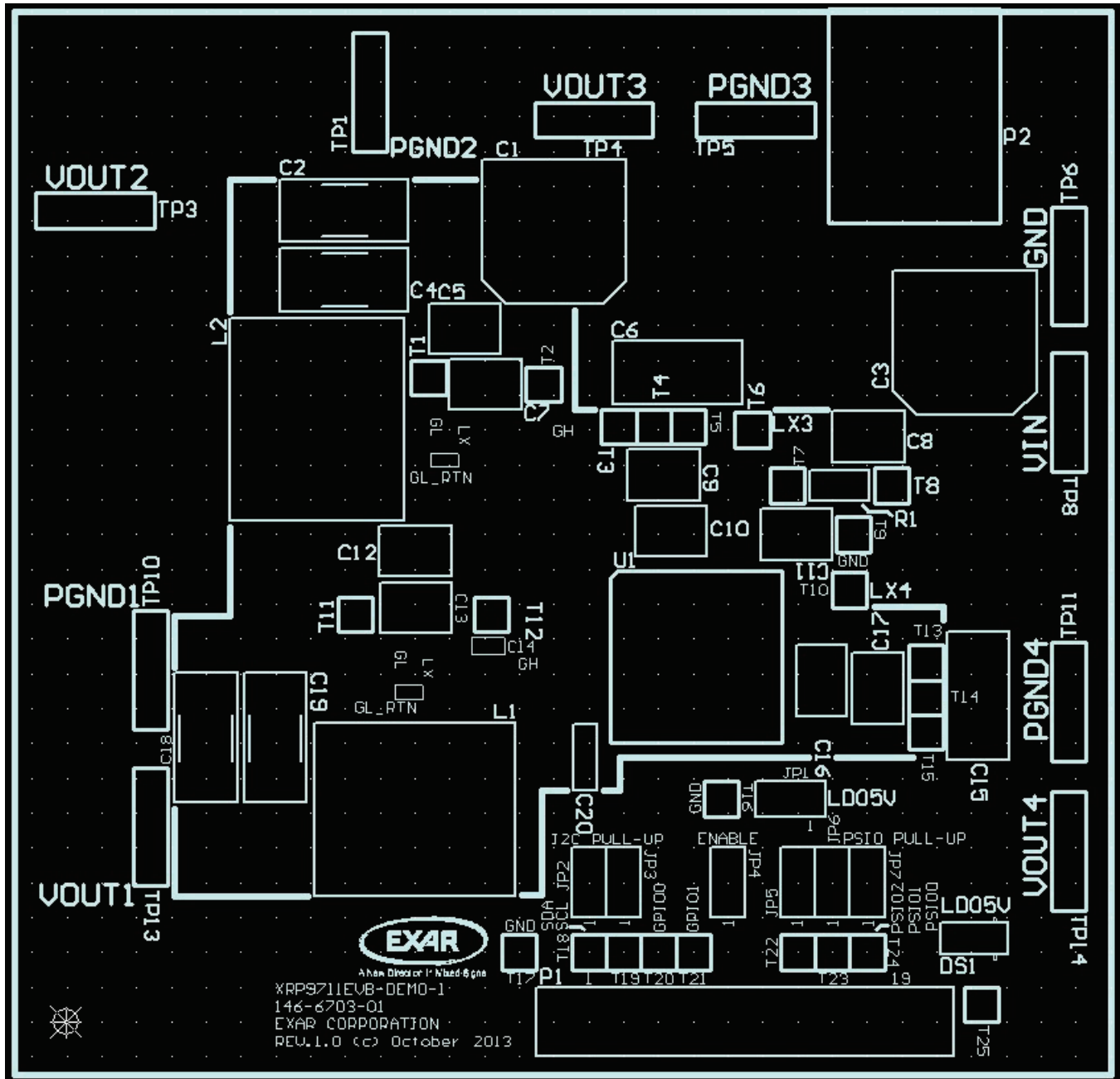

Figure 3 Component Placement – Top Side

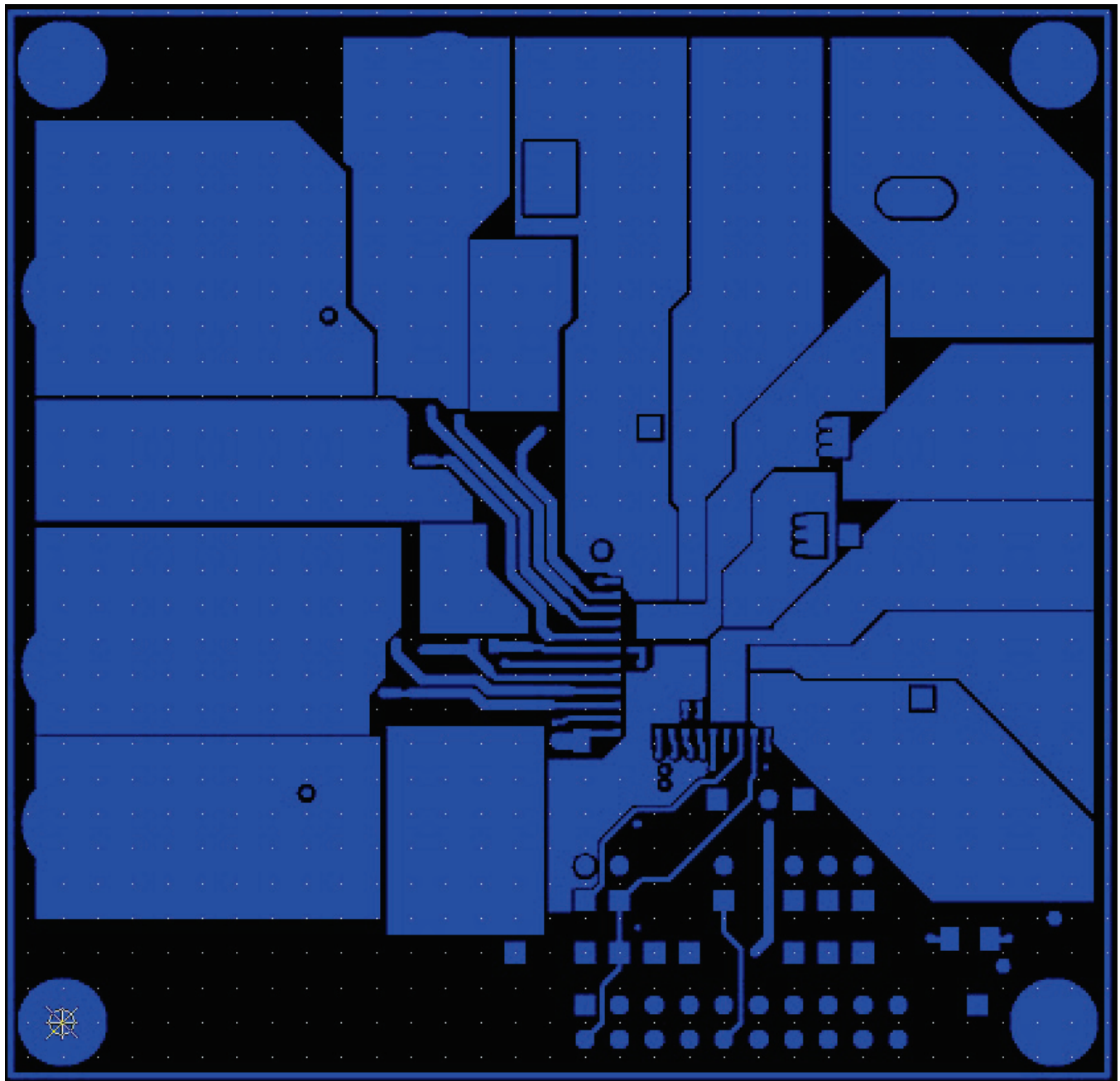

Figure 4 Layout – Top Layer

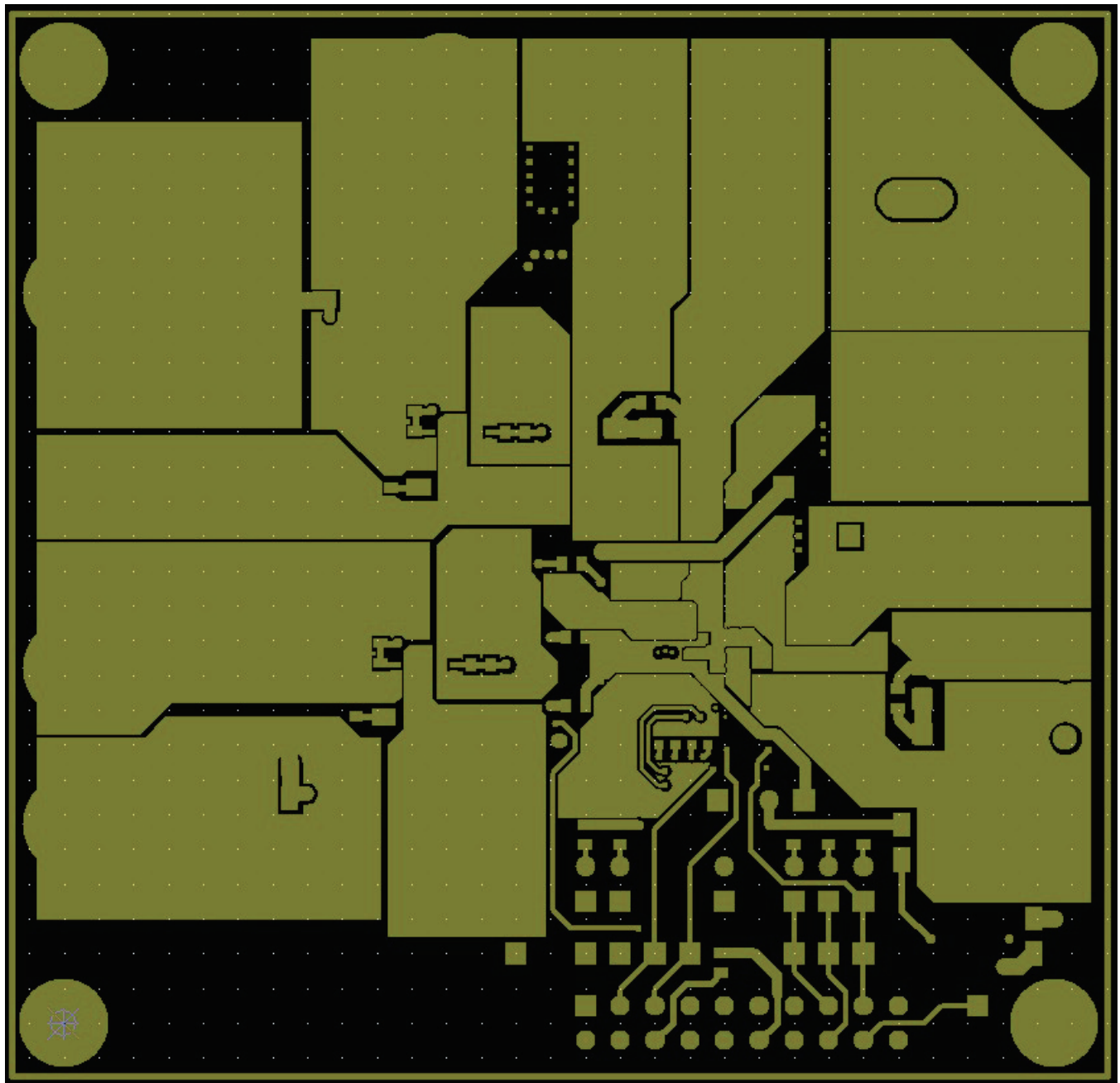

Figure 5 Layout – Bottom Layer

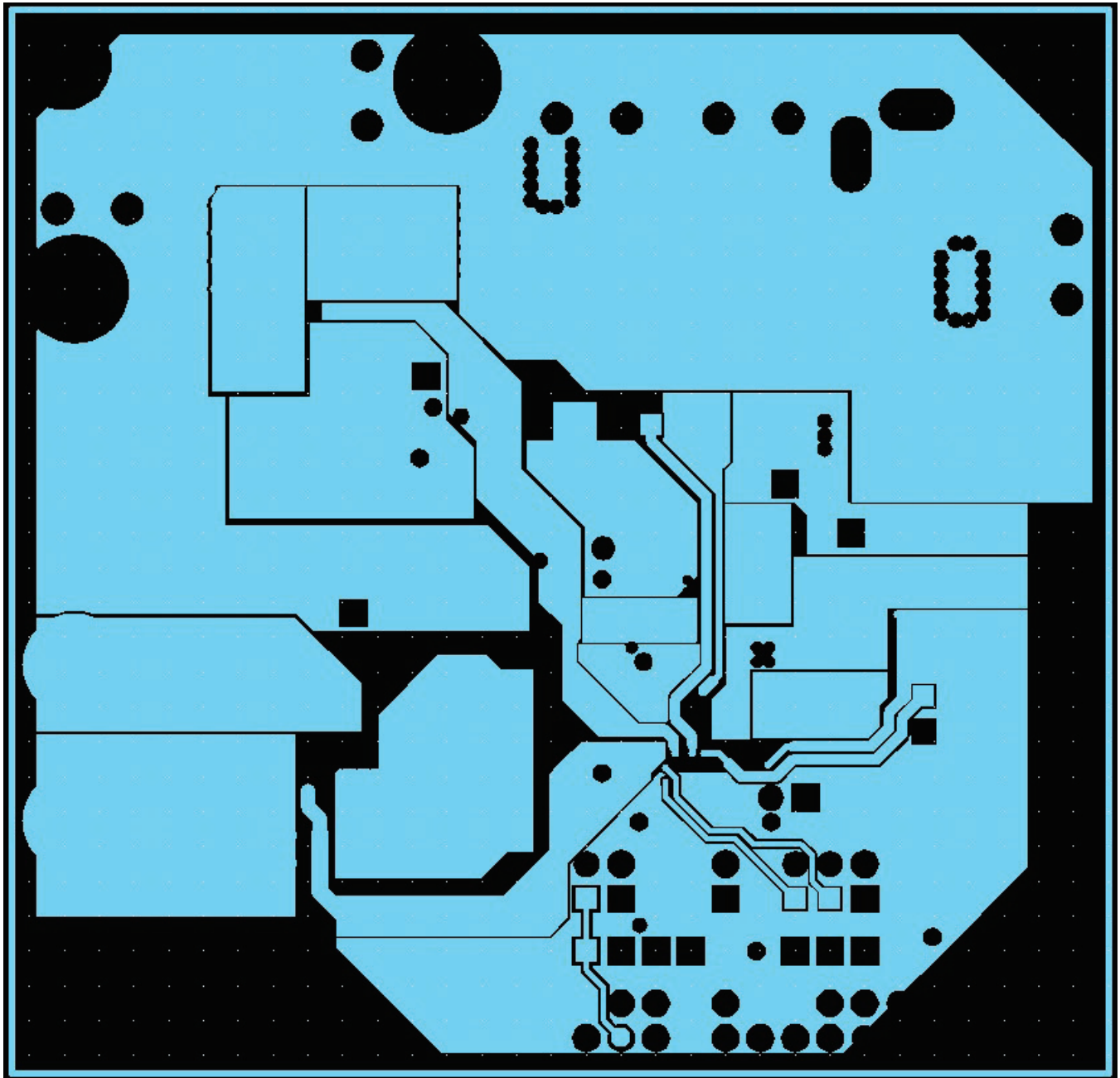

Figure 6 Layout – Middle Layer 1

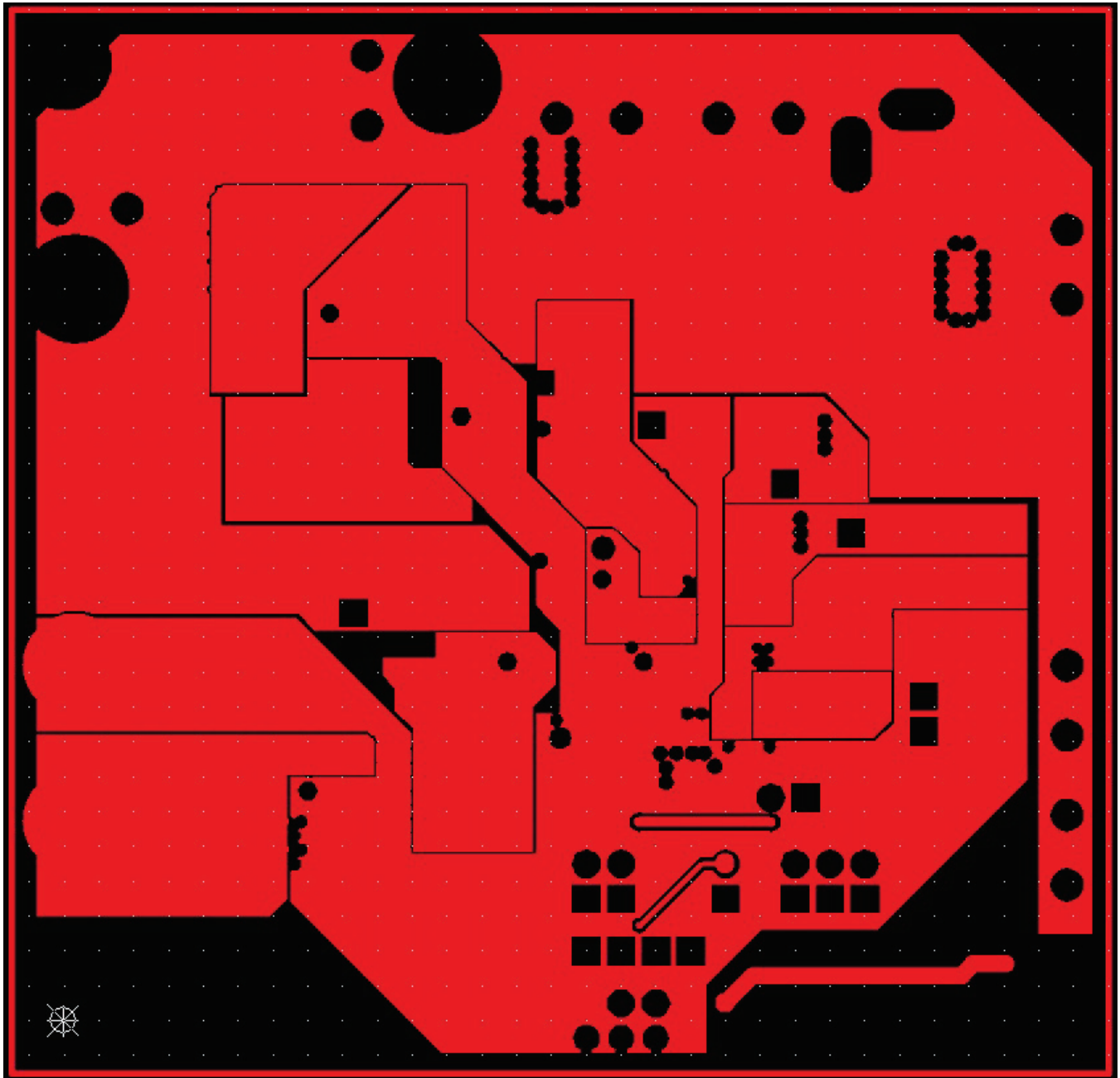

Figure 7 Layout – Middle Layer 2

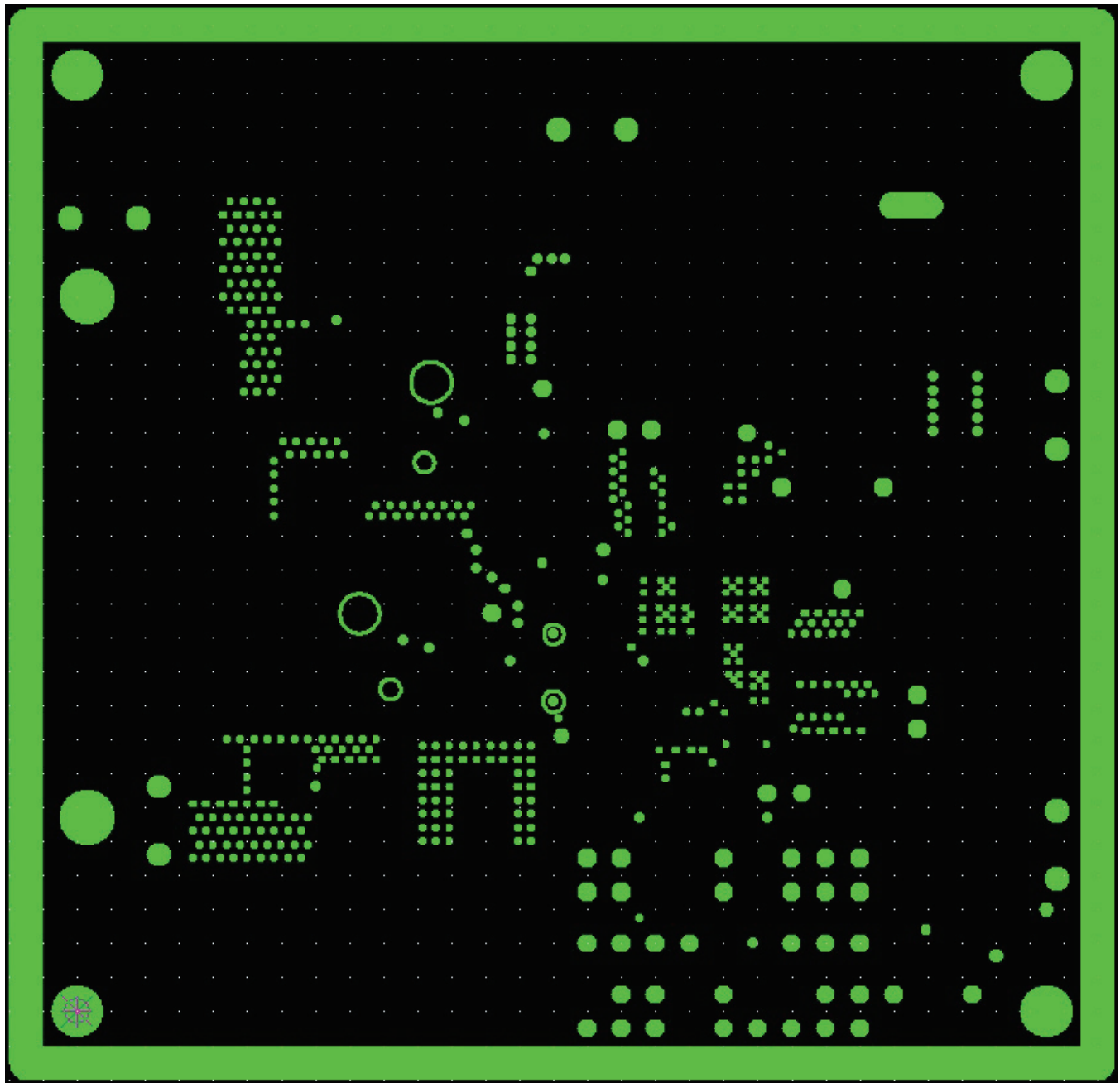

Figure 8 Layout – Signal Ground Plane

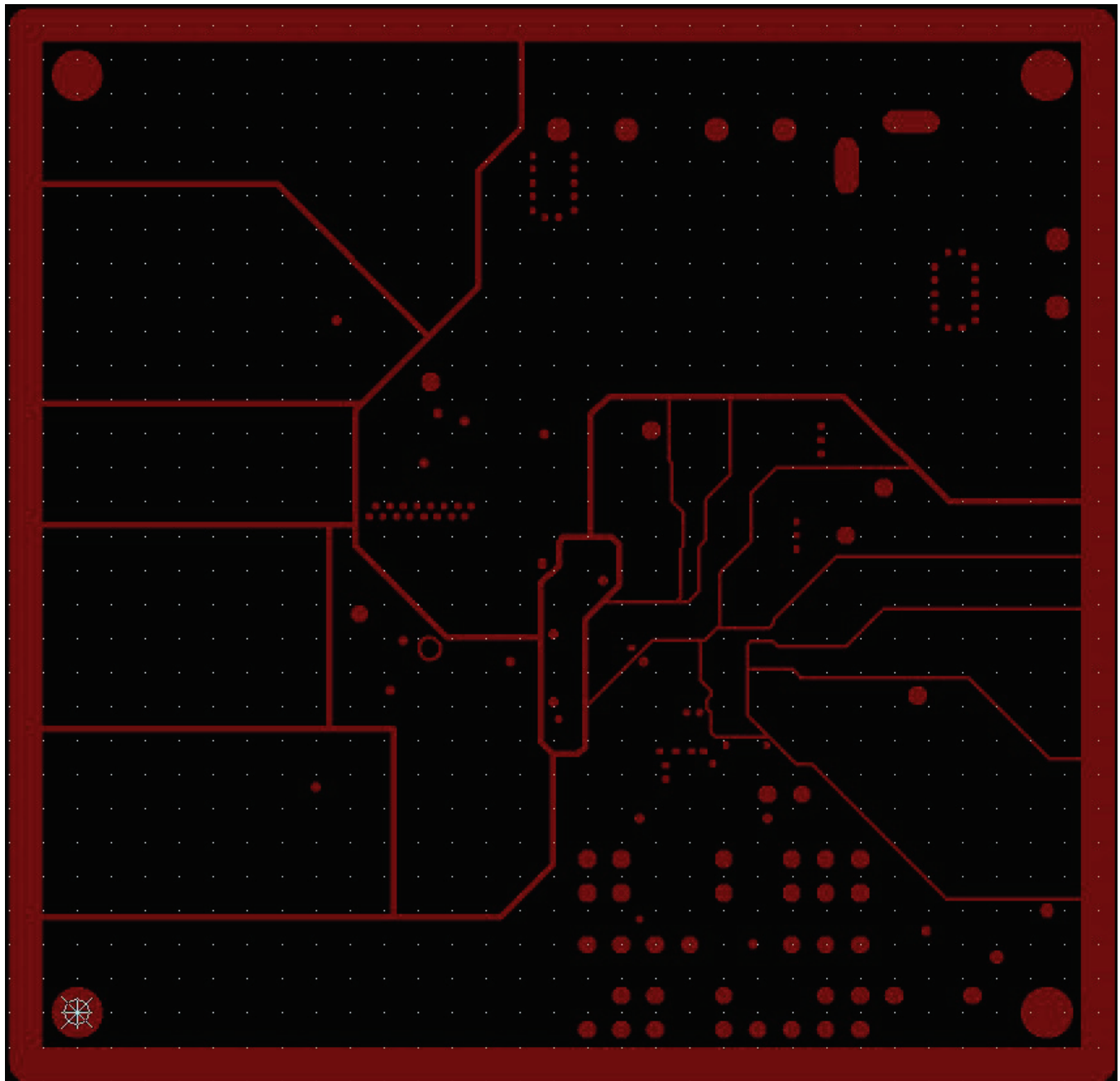
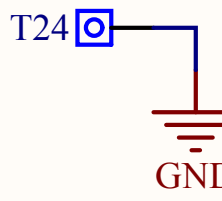
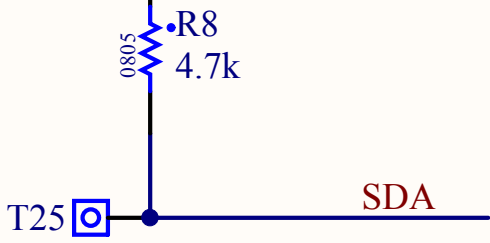
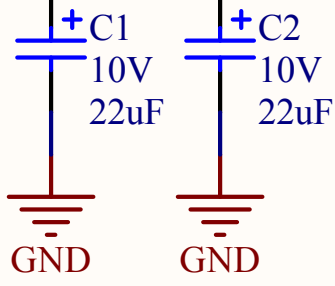

Figure 9 Layout – Internal Plane

I2C_POWER

+5V

C



D



1

2

BILL OF MATERIAL

Ref.	Qty	Manufacturer	Part Number	Size	Component
	1	Exar Corporation	146-6703-01	4.40x2.10	PCB
DS1	1	Würth Elektronik	150120RS75000	1206	SMD Red Chip LED
DS2	1	Würth Elektronik	150120VS75000	1206	SMD Green Chip LED
C1, C2, C3, C4	4	Vishay Sprague	293D226X9010B2TE3	B	Tantalum Capacitor 22 μ F, 10V, 10%
R1, R5, R6, R9	4	Panasonic	ERJ-6GEY0R00V	0805	RES 0 Ω , 1/8W, 5% SMD
R2, R3	2	Panasonic	ERJ-6GEYJ122V	0805	RES 1.2k Ω , 1/8W, 5%, SMD
R4, R7, R8	3	Panasonic	ERJ-6GEYJ472V	0805	RES 4.7k Ω , 1/8W, 5%, SMD
SW1	1	Würth Elektronik	430182050816	6x6mm	Tact Switch, SMD
CON5	1	Würth Elektronik	61301021121	0.50x0.20in	Connector, Male Header, 10 Positions, Dual Row, 100mil Spacing, Vertical, TH
JP1, JP2, JP3, JP4, JP5	5	Würth Elektronik	61300211121	0.20x0.10in	Connector, Male Header, 2 Positions, 100mil Spacing, Vertical, TH
JP6, JP7	2	Würth Elektronik	61300311121	0.30x0.10in	Connector, Male Header, 3 Positions, 100mil Spacing, Vertical, TH
P1	1	Würth Elektronik	612020235221	1.20x0.55in	Connector, Male Header, 20 Positions, Dual Row, 100mil Spacing, Shrouded, RA, TH
P2	1	Würth Elektronik	653104124022	11x6mm	Wire-to-Board Connector, Male, 4 Positions, 1.25mm Spacing, Shrouded, SMT
P_IOH1	1	Würth Elektronik	61301011121	1.00x0.10in	Connector, Male Header, 10 Positions, 100mil Spacing, Vertical, TH
P_POWER1, P_IOL1	2	Würth Elektronik	61300811121	0.80x0.10in	Connector, Male Header, 8 Positions, 100mil Spacing, Vertical, TH
P_AD1	1	Würth Elektronik	61300611121	0.60x0.10in	Connector, Male Header, 6 Positions, 100mil Spacing, Vertical, TH
T23, T24, T25	3	Würth Elektronik	61300111121	0.10x0.10in	Square Test Posts, TH



XRP9711EVB-DEMO-1

Quad Channel Digital PWM/PFM Demo Board Programmable Power Management System

DOCUMENT REVISION HISTORY

Revision	Date	Description
1.0.0	01/07/2014	Initial release of document

BOARD REVISION HISTORY

Board Revision	Date	Description
XRP9711EVB-DEMO-1-01	12/20/13	Initial release of evaluation board

FOR FURTHER ASSISTANCE

Email:

customersupport@exar.com

powertechsupport@exar.com

Exar Technical Documentation:

<http://www.exar.com/TechDoc/default.aspx?>



EXAR CORPORATION

HEADQUARTERS AND SALES OFFICES

48720 Kato Road

Fremont, CA 94538 – USA

Tel.: +1 (510) 668-7000

Fax: +1 (510) 668-7030

www.exar.com

NOTICE

EXAR Corporation reserves the right to make changes to the products contained in this publication in order to improve design, performance or reliability. EXAR Corporation assumes no responsibility for the use of any circuits described herein, conveys no license under any patent or other right, and makes no representation that the circuits are free of patent infringement. Charts and schedules contained here in are only for illustration purposes and may vary depending upon a user's specific application. While the information in this publication has been carefully checked; no responsibility, however, is assumed for inaccuracies.

EXAR Corporation does not recommend the use of any of its products in life support applications where the failure or malfunction of the product can reasonably be expected to cause failure of the life support system or to significantly affect its safety or effectiveness. Products are not authorized for use in such applications unless EXAR Corporation receives, in writing, assurances to its satisfaction that: (a) the risk of injury or damage has been minimized; (b) the user assumes all such risks; (c) potential liability of EXAR Corporation is adequately protected under the circumstances.

Reproduction, in part or whole, without the prior written consent of EXAR Corporation is prohibited.

X-ON Electronics

Largest Supplier of Electrical and Electronic Components

Click to view similar products for [Power Management IC Development Tools](#) category:

Click to view products by [MaxLinear](#) manufacturer:

Other Similar products are found below :

[EVB-EP5348UI](#) [MIC23451-AAAYFL EV](#) [MIC5281YMME EV](#) [124352-HMC860LP3E](#) [DA9063-EVAL](#) [ADP122-3.3-EVALZ](#) [ADP130-0.8-EVALZ](#) [ADP130-1.8-EVALZ](#) [ADP1740-1.5-EVALZ](#) [ADP1870-0.3-EVALZ](#) [ADP1874-0.3-EVALZ](#) [ADP199CB-EVALZ](#) [ADP2102-1.25-EVALZ](#) [ADP2102-1.875EVALZ](#) [ADP2102-1.8-EVALZ](#) [ADP2102-2-EVALZ](#) [ADP2102-3-EVALZ](#) [ADP2102-4-EVALZ](#) [AS3606-DB](#) [BQ25010EVM](#) [BQ3055EVM](#) [ISLUSBI2CKIT1Z](#) [LM2734YEVAL](#) [LP38512TS-1.8EV](#) [EVAL-ADM1186-1MBZ](#) [EVAL-ADM1186-2MBZ](#) [ADP122UJZ-REDYKIT](#) [ADP166Z-REDYKIT](#) [ADP170-1.8-EVALZ](#) [ADP171-EVALZ](#) [ADP1853-EVALZ](#) [ADP1873-0.3-EVALZ](#) [ADP198CP-EVALZ](#) [ADP2102-1.0-EVALZ](#) [ADP2102-1-EVALZ](#) [ADP2107-1.8-EVALZ](#) [ADP5020CP-EVALZ](#) [CC-ACC-DBMX-51](#) [ATPL230A-EK](#) [MIC23250-S4YMT EV](#) [MIC26603YJL EV](#) [MIC33050-SYHL EV](#) [TPS60100EVM-131](#) [TPS65010EVM-230](#) [TPS71933-28EVM-213](#) [TPS72728YFFEVM-407](#) [TPS79318YEQEV](#) [ISL85033EVAL2Z](#) [UCC28810EVM-002](#) [XILINXPWR-083](#)