

| | | | |
|-----------|---|------|-----------------|
| Dimension | | | |
| L | * | W | * H |
| 325.8 | * | 107 | * 41 (1U) mm |
| 12.8 | * | 4.21 | * 1.61(1U) inch |



Features

- Charger for lead-acid batteries (Gel, flooded and AGM) and Li-ion batteries (lithium iron and lithium manganese)
- Built-in default 3 stage charging curves and programmable curve
- Built-in I²C interface, PMBus protocol (Optional CANBus protocol)
- Universal AC input / Full range
- Built-in active PFC function
- Forced air cooling by built-in thermal controlled DC fans
- Output voltage and current programmable
- Built-in OR-ing FET
- Active current sharing up to 6400W(1+1)
- Protections: Battery under voltage / Battery no connection / Short circuit / Over voltage / Over temperature
- Optional conformal coating
- 5 years warranty

Applications

- Large scale DC UPS or emergency backup system
- Marine battery charger module
- Electric scooter or vehicle charger station
- Wastewater treatment system
- Electrolysis system

Description

DBU-3200 is a 3200W single output AC/DC enclosed charger in 1U low profile with high power density, 37W/inch³. It is an intelligent charger that has pre-loaded programmable charging curves for different types of lead-acid and li-ion batteries. Output programmable function allows user to adjust the charging voltage and current via the built-in potentiometer or PMBus protocol. Various protection mechanisms as well as the temperature compensation function are provided to assure normal and safe system operation.

Model Encoding / Order Information

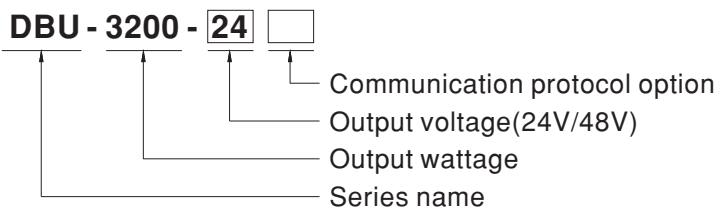

| Type | Communication Protocol | Note |
|-------|------------------------|------------|
| Blank | PMBus protocol | In Stock |
| CAN | CANBus protocol | By request |



SPECIFICATION

| MODEL | | DBU-3200-24 | DBU-3200-48 | |
|-------------------------------------|---|--|--|---|
| OUTPUT | BOOST CHARGE VOLTAGE(Vboost)(default) | 28.8V | 57.6V | |
| | FLOAT CHARGE VOLTAGE(Vfloat)(default) | 27.6V | 55.2V | |
| | CONSTANT CURRENT(CC)(default) | 110A | 55A | |
| | VOLTAGE ADJ. RANGE | By built-in potentiometer, SVR | | |
| | | 23.5 ~ 30V | 47.5 ~ 58.8V | |
| | RECOMMENDED BATTERY CAPACITY(AMP HOURS) Note.3 | 330 ~ 1000Ah | 180 ~ 550Ah | |
| LEAKAGE CURRENT FROM BATTERY (Typ.) | 1.5mA | | | |
| INPUT | VOLTAGE RANGE Note.4 | 90 ~ 264VAC 127 ~ 370VDC | | |
| | FREQUENCY RANGE | 47 ~ 63Hz | | |
| | POWER FACTOR (Typ.) | 0.97/230VAC at full load | | |
| | EFFICIENCY (Typ.) | 93.5% | 94.5% | |
| | AC CURRENT (Typ.) Note.4 | 17A/230VAC | | |
| | INRUSH CURRENT (Typ.) | COLD START 55A/230VAC | | |
| | LEAKAGE CURRENT | <2mA / 230VAC | | |
| PROTECTION | OVER VOLTAGE | 31.5 ~ 37.5V | 63 ~ 75V | |
| | | Protection type : Shut down o/p voltage, re-power on to recover | | |
| | OVER TEMPERATURE | Shut down o/p voltage, recovers automatically after temperature goes down | | |
| FUNCTION | OUTPUT VOLTAGE PROGRAMMABLE(PV) | Adjustment of output voltage is allowable to 75 ~ 125% of nominal output voltage. Please refer to the Function Manual. | | |
| | OUTPUT CURRENT PROGRAMMABLE(PC) | Adjustment of output voltage is allowable to 20 ~ 100% of rated current. Please refer to the Function Manual. | | |
| | AUXILIARY POWER | 5V @ 0.3A, tolerance ±10%, ripple 150mVp-p, 12V @ 0.8A, tolerance ±10%, ripple 450mVp-p | | |
| | REMOTE ON-OFF CONTROL | By electrical signal or dry contact Power ON:short Power OFF:open. Please refer to the Function Manual | | |
| | TEMPERATURE COMPENSATION | -3mV / °C / cell / (12V = 6 cells ; 24V = 12 cells ; 48V = 24 cells) | | |
| | ALARM SIGNAL | Isolated signal output for T-alarm and DC-OK | | |
| ENVIRONMENT | WORKING TEMP. | -30 ~ +70°C (Refer to "Derating Curve") | | |
| | WORKING HUMIDITY | 20 ~ 90% RH non-condensing | | |
| | STORAGE TEMP., HUMIDITY | -40 ~ +85°C, 10 ~ 95% RH non-condensing | | |
| | TEMP. COEFFICIENT | ±0.03%/°C (0 ~ 50°C) | | |
| | VIBRATION | 10 ~ 500Hz, 2G 10min./1cycle, 60min. each along X, Y, Z axes | | |
| SAFETY & EMC (Note 6) | SAFETY STANDARDS | UL62368-1, CSA C22.2 No. 62368-1, TUV EN62368-1, EAC TP TC 004 approved | | |
| | WITHSTAND VOLTAGE | I/P-O/P:3KVAC I/P-FG:2KVAC O/P-FG:1.5KVAC | | |
| | ISOLATION RESISTANCE | I/P-O/P, I/P-FG, O/P-FG:100M Ohms / 500VDC / 25°C / 70% RH | | |
| | EMC EMISSION | Parameter | Standard | Test Level / Note |
| | | Conducted | EN55032 (CISPR32) | Class B |
| | | Radiated | EN55032 (CISPR32) | Class A |
| | | Harmonic Current | EN61000-3-2 | ----- |
| | | Voltage Flicker | EN61000-3-3 | ----- |
| | EMC IMMUNITY | EN55024 , EN61204-3, EN61000-6-2 | | |
| | | Parameter | Standard | Test Level / Note |
| | | ESD | EN61000-4-2 | Level 3, 8KV air ; Level 2, 4KV contact |
| | | Radiated | EN61000-4-3 | Level 3 |
| | | EFT / Burst | EN61000-4-4 | Level 3 |
| | | Surge | EN61000-6-2 | 2KV/Line-Line 4KV/Line-Earth |
| Conducted | | EN61000-4-6 | Level 3 | |
| Magnetic Field | | EN61000-4-8 | Level 4 | |
| Voltage Dips and Interruptions | | EN61000-4-11 | >95% dip 0.5 periods, 30% dip 25 periods, >95% interruptions 250 periods | |
| OTHERS | MTBF | 160.1K hrs min. Telcordia SR-332 (Bellcore) ; 38.9K hrs min. MIL-HDBK-217F (25°C) | | |
| | DIMENSION | 325.8*107*41mm (L*W*H) | | |
| | PACKING | 2.76Kg;4pcs/12Kg/0.83CUFT | | |
| NOTE | <p>1. Modification for charger specification may be required for different battery specification. Please contact battery vendor and MEAN WELL for details.</p> <p>2. All parameters NOT specially mentioned are measured at 230VAC input, rated load and 25°C of ambient temperature.</p> <p>3. This is MEAN WELL's suggested range. Please consult your battery manufacturer for their suggestions about maximum charging current limitation.</p> <p>4. Derating may be needed under low input voltages. Please check the derating curve for more details.</p> <p>5. The charger is considered a component which will be installed into a final equipment. All the EMC tests are been executed by mounting the unit on a 600mm*900mm metal plate with 1mm of thickness. The final equipment must be re-confirmed that it still meets EMC directives. For guidance on how to perform these EMC tests, please refer to "EMI testing of component power supplies." (as available on http://www.meanwell.com)</p> <p>6. The ambient temperature derating of 3.5°C/1000m with fanless models and of 5°C/1000m with fan models for operating altitude higher than 2000m(6500ft).</p> | | | |

■ BLOCK DIAGRAM

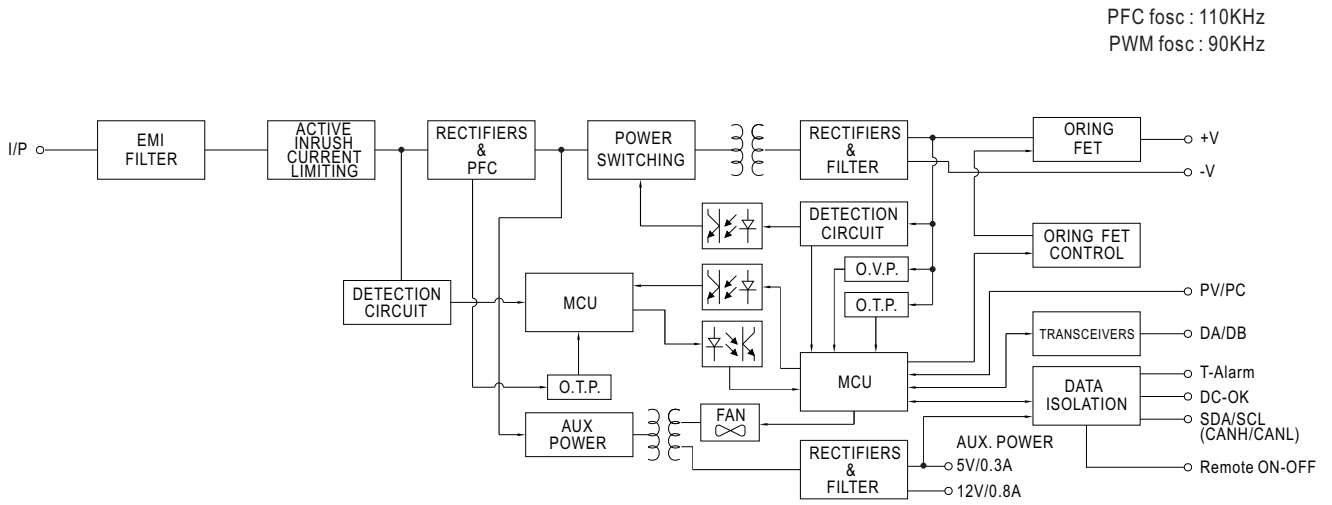

■ DERATING CURVE

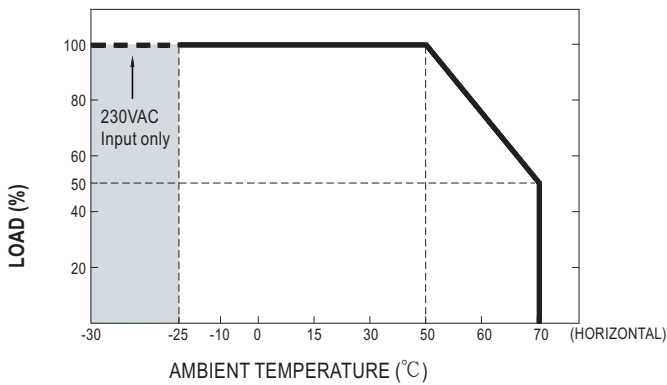

■ STATIC CHARACTERISTICS

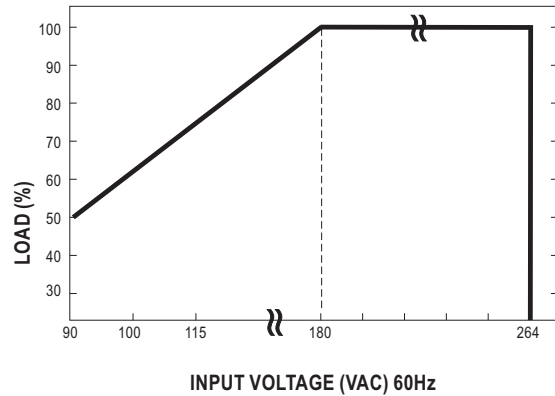

FUNCTION MANUAL

1. PMBus Communication Interface

DBU-3200 supports PMBus Rev. 1.1 with maximum 100KHz bus speed, allowing information reading, status monitoring, output trimming, etc. For details, please refer to the Installation Manual.

2. Charging Curve

- ※ By factory default, this charger performs the default curve which can be programmed via PMBus.
- ※ To disable / enable the charging curve, change to a 2 stage curve, a different curve frequently used for certain types of batteries in the industry, and so on, please refer to the Installation Manual.
- ※ To program the parameters of the charging curve, SBP-001, the smart battery charging programmer designed by MEAN WELL, and a personal computer are needed. Please contact MEAN WELL for details.

⊙ Default 3 stage charging curve

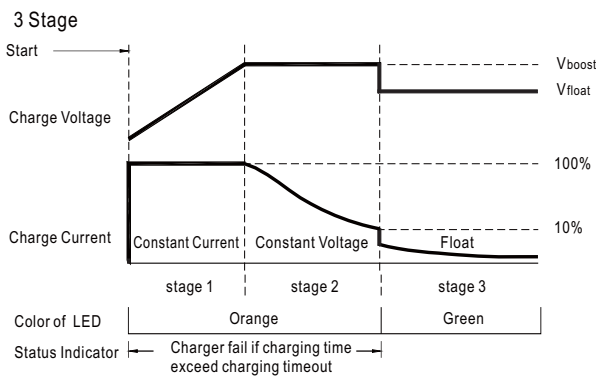

⊙ Embedded 3 stage charging curves

| MODEL | Description | Vboost | Vfloat | CC(default) |
|-------|------------------------------|--------|--------|-------------|
| 24V | Default, programmable | 28.8 | 27.6 | 110A |
| | Pre-defined, gel batter | 28 | 27.2 | |
| | Pre-defined, flooded battery | 28.4 | 26.8 | |
| | Pre-defined, AGM battery | 29 | 27 | |
| 48V | Default, programmable | 57.6 | 55.2 | 55A |
| | Pre-defined, gel batter | 56 | 54.4 | |
| | Pre-defined, flooded battery | 56.8 | 53.6 | |
| | Pre-defined, AGM battery | 58 | 54 | |

Note:

When using this charger unit, please configured the system with recommended battery capacity defined by specification . Should battery capacity in use be much smaller so that user needs to set a low current for charging, under such condition it might cause higher current ripple.

⊙ Suitable for lead-acid batteries (flooded, Gel and AGM) and Li-ion batteries (lithium iron and lithium manganese).

3. Front Panel LED Indicators & Corresponding Signal at Function Pins

| LED | Description |
|------------------|---|
| ● Green | Float (stage 3) |
| ● Orange | Charging (stage 1 or stage 2) |
| ● Red | The LED will present a constant red light when the abnormal status (OTP, OLP, fan fail and charging timeout) arises. |
| ● Red (Flashing) | The LED will flash with the red light when the internal temperature reaches 60°C; under this condition, the unit still operates normally without entering OTP. (In the meantime, an alarm signal will be sent out through the PMBus interface.) |

4. Output Voltage Programming (or, PV / remote voltage programming / remote adjust / margin programming / dynamic voltage trim)

※ In addition to the adjustment via the built-in potentiometer, the output voltage can be trimmed by applying EXTERNAL VOLTAGE.

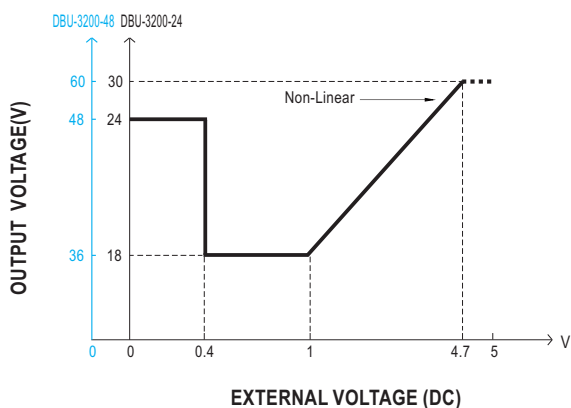
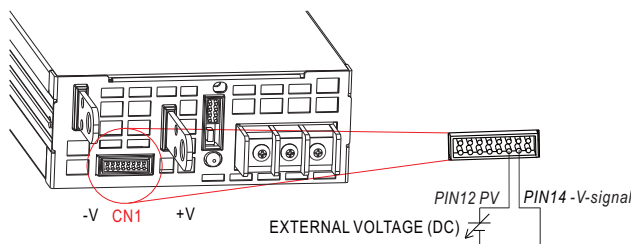

5. Output Current Programming (or, PC / remote current programming / dynamic current trim)

※ The output current can be trimmed to 20~100% of the rated current by applying EXTERNAL VOLTAGE.

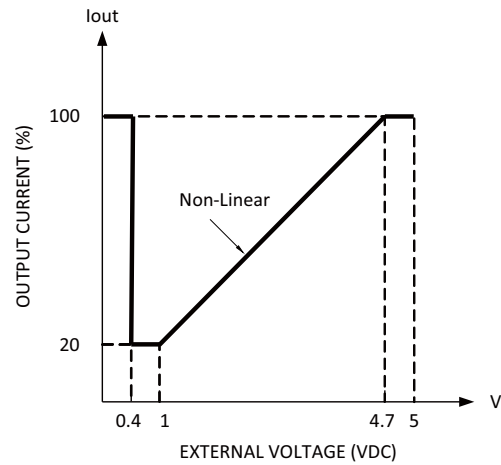
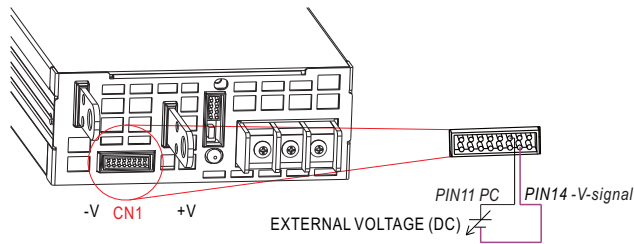

6. Remote ON-OFF Control

The power supply can be turned ON/OFF individually or along with other units in parallel by using the "Remote ON-OFF" function.

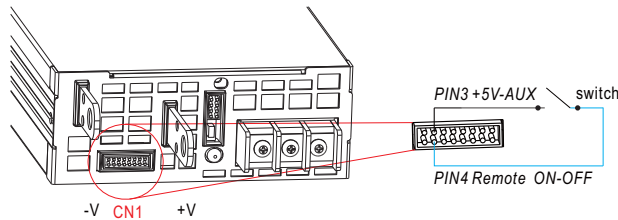

| Between Remote ON-OFF and +5V-AUX | Power Supply Status |
|-----------------------------------|---------------------|
| Switch Short | ON |
| Switch Open | OFF |

7. Temperature Compensation

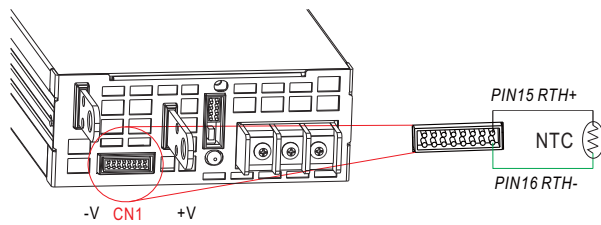

- ◎ To exploit the temperature compensation function, please attach the temperature sensor, NTC, which is enclosed with the charger, to the battery or the battery's vicinity.
- ◎ The charger is able to work normally without the NTC.

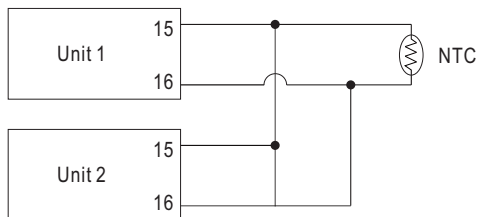

When multiple chargers are connected in parallel, please configure with the NTC as exhibited in the diagram .
If the temperature compensation is not required, RTH+ (PIN15) and RTH- (PIN16) from each unit still need to be connected.

8. Alarm Signal Output

※ There are 2 alarm signals, DC OK and T-ALARM, in TTL signal form, on CN1. These signals are isolated from output. The maximum sink current is 10mA.

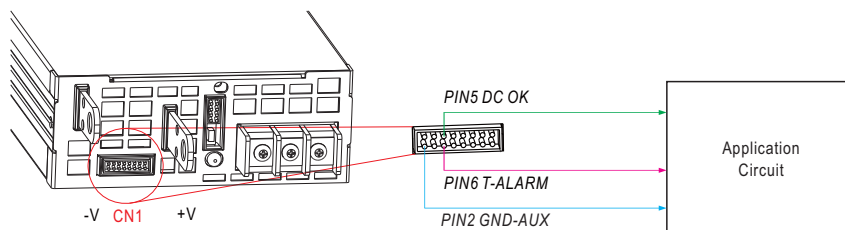

9. Current Sharing

DBU-3200 has the built-in active current sharing function and can be connected in parallel, up to 2 units, to provide higher output power as exhibited below :

- ※ The power supplies to be paralleled should use short and large diameter wiring and then connected to the load.
- ※ Difference of output voltages among parallel units should be less than 0.2V.
- ※ The total output current must not exceed the value calculated by the following equation:

$$\text{Maximum output current at parallel operation} = (\text{Rated current per unit}) \times (\text{Number of unit}) \times 0.9$$
- ※ When the total output current is less than 5% of the total rated current, or say $(5\% \text{ of Rated current per unit}) \times (\text{Number of unit})$ the current shared among units may not be balanced.
- ※ CN500/SW1 Function pin connection

| Parallel | PSU1 | | PSU2 | |
|----------|-------|-----|-------|-----|
| | CN500 | SW1 | CN500 | SW1 |
| 1 unit | X | ON | — | — |
| 2 unit | V | ON | V | ON |

(V : CN500 connected ; X : CN500 not connected.)

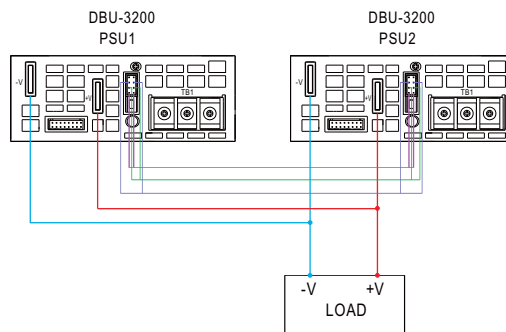
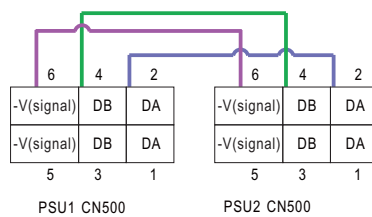

Fig 5.1



↑
If the lines of CN500 are too long, they should be twisted in pairs to avoid the noise.

◎ DA, DB and -V(signal) are connected mutually in parallel.

MECHANICAL SPECIFICATION

Case No.256 Unit:mm

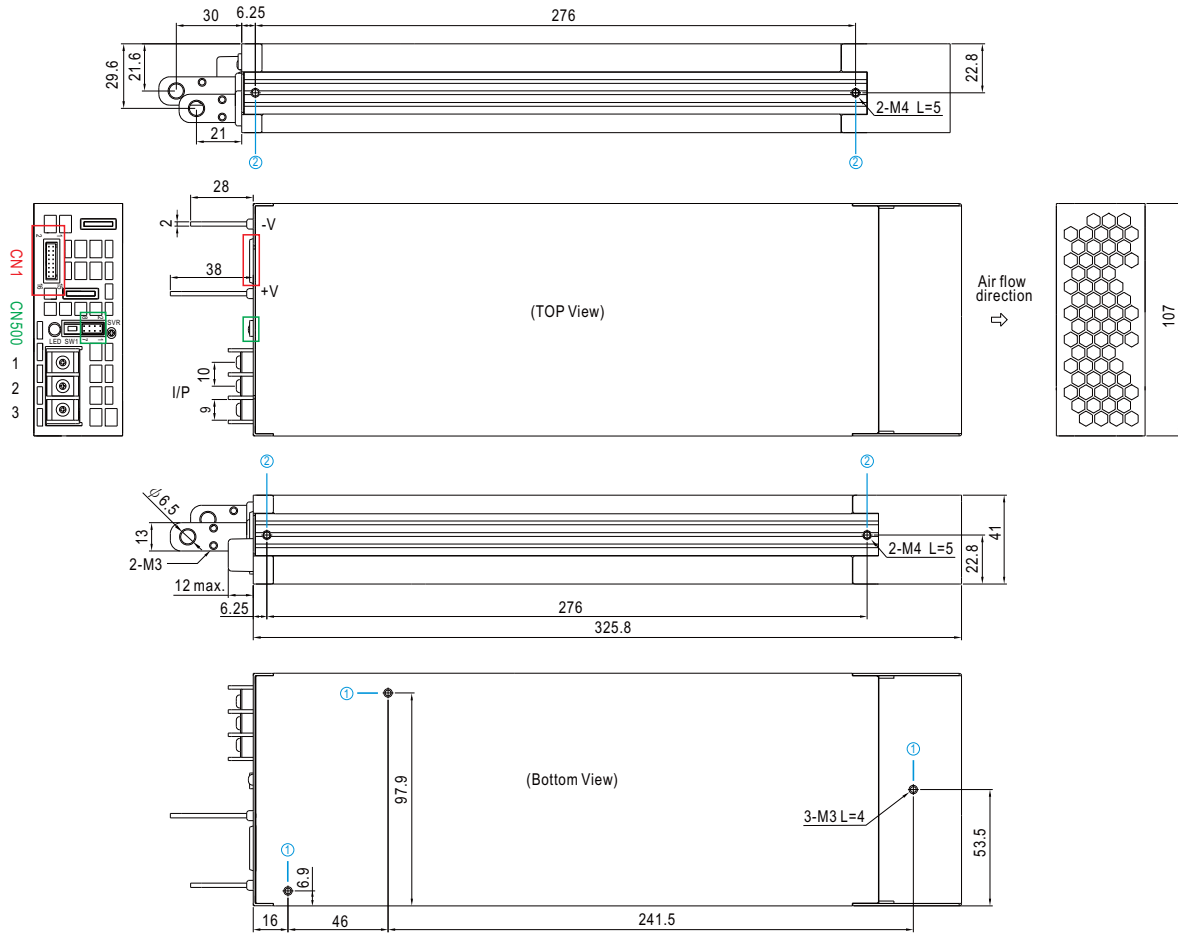

Mounting Instruction

| Hole No. | Recommended Screw Size | MAX. Penetration Depth L | Recommended mounting torque |
|----------|------------------------|--------------------------|-----------------------------|
| ① | M3 | 6mm | 6~8Kgf-cm |
| ② | M4 | 7mm | 7~10Kgf-cm |

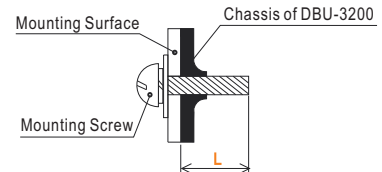

Control Pin No. Assignment(CN1) : HRS DF11-16DP-2DS or equivalent

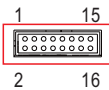

| | |
|----------------|-----------------------------|
| Mating Housing | HRS DF11-16DS or equivalent |
| Terminal | HRS DF11-16SC or equivalent |

| Pin No. | Function | Description |
|---------|---------------|--|
| 1 | +12V-AUX | Auxiliary voltage output, 10.6~13.2V, referenced to GND-AUX (pin2). The maximum load current is 0.8A. This output has the built-in "Oring diodes" and is not controlled by "Remote ON-OFF". |
| 2 | GND-AUX | Auxiliary voltage output GND. The signal return is isolated from the output terminals (+V & -V). |
| 3 | +5V-AUX | Auxiliary voltage output, 4.5~5.5V, referenced to GND-AUX (pin2). The maximum load current is 0.3A. This output has the built-in "Oring diodes" and is not controlled by "Remote ON-OFF". |
| 4 | Remote ON-OFF | The unit can turn the output ON/OFF by electrical signal or dry contact between Remote ON/OFF and +5V-AUX. (Note.2) Short (4.5 ~ 5.5V) : Power ON ; Open (-0.1 ~ 0.5V) : Power OFF ; The maximum input voltage is 5.5V. |
| 5 | DC-OK | High (4.5 ~ 5.5V) : When the Vout ≤ 16V/32V ±1V. Low (-0.1 ~ 0.5V) : When Vout ≥ 16V/32V ±1V. The maximum sourcing current is 10mA and only for output. (Note.2) DC OK is associated with battery low protection. |
| 6 | T-ALARM | High (4.5 ~ 5.5V) : When the internal temperature exceeds the limit of temperature alarm, or when Fan fails. Low (-0.1 ~ 0.5V) : When the internal temperature is normal, and when Fan works normally. The maximum sourcing current is 10mA and only for output.(Note.2) |
| 7,8,9 | A0,A1,A2 | PMBus interface address lines. (Note.1) |
| 10 | D0 | DIP-switch interface lines for charging curve selection. (Note.1) |
| 11 | PC | Connection for output current programming. (Note.1) |
| 12 | PV | Connection for output voltage programming. (Note.1) |
| 13 | +V (Signal) | Positive output voltage signal. It cannot be connected directly to the load. |
| 14 | -V (Signal) | Negative output voltage signal. It is for certain function reference; it cannot be connected directly to the load. |
| 15 | RTH+ | Temperature sensor(NTC, 5KOhm) comes along with the charger can be connected to the unit to allow temperature compensation of the charging voltage. |
| 16 | RTH- | |

Note1: Non-isolated signal, referenced to the [-V(signal)].

Note2: Isolated signal, referenced to GND-AUX.

※AC Input Terminal Pin No. Assignment

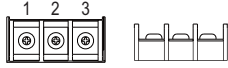
| Pin No. | Assignment | Diagram | Maximum mounting torque |
|---------|------------|---|-------------------------|
| 1 | FG 地 |  | 8Kgf-cm |
| 2 | AC/N | | |
| 3 | AC/L | | |

※Control Pin No. Assignment(CN500) : HRS DF11-8DP-2DS or equivalent

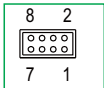

| | |
|----------------|------------------------------|
| Mating Housing | HRS DF11-8DS or equivalent |
| Terminal | HRS DF11-8**SC or equivalent |

| Pin No. | Function | Description |
|---------|-------------|--|
| 1, 2 | DA | Differential digital signal for parallel control. |
| 3, 4 | DB | Differential digital signal for parallel control. |
| 5, 6 | -V (Signal) | Negative output voltage signal. It is for local sense; and certain function reference; it cannot be connected directly to the load. |
| 7 | NC | For standard model: None. |
| | SDA | For PMBus model: Serial Data used in the PMBus interface. (Note) |
| | CANH | For CANBus model: Data line used in CANBus interface. (Note) |
| 8 | NC | For standard model: None. |
| | SCL | For PMBus model: Serial Clock used in the PMBus interface. (Note) |
| | CANL | For CANBus model: Data line used in CANBus interface. (Note) |

Note: Isolated signal, referenced to GND-AUX.

※Control Pin No. Assignment.(SW1)

| Pin No. | Function | Description |
|---------|---------------------|--|
| 1, 2 | Terminal resistance | SW1 is the selector of terminal resistor that is designed for DA/DB signals and parallel control function. |

■ **INSTALLATION MANUAL**

Please refer to : <http://www.meanwell.com/manual.html>

X-ON Electronics

Largest Supplier of Electrical and Electronic Components

Click to view similar products for [Battery Chargers](#) category:

Click to view products by [Mean Well](#) manufacturer:

Other Similar products are found below :

[CH0014](#) [CH0011](#) [CB1210A](#) [PS-034052](#) [CB123A](#) [CB2410A](#) [DA60U-240A-R](#) [DA200U-250A-R](#) [MC2](#) [1200296](#) [BQ-CC55E](#) [LCD MULTI CHARGER](#) [MINI-CHARGER](#) [PB320](#) [PB50](#) [VC4](#) [POCKET-CHARGER + 4XAA 2100MAH](#) [PB-300P-12](#) [VC2](#) [MINI CHARGER + 2XAA 2100MAH](#) [CHFC3](#) [GC30U-5P1J](#) [TSP-BCM48](#) [SBP-001](#) [PB-300N-12](#) [GC30B-11P1J](#) [GC220A12-AD1](#) [DBU-3200-48](#) [TSP-BCM12](#) [TSP-BCM360](#) [H-TRONIC AL 2000PLUS](#) [ES240J](#) [ES360A](#) [LS-CR45-PQ](#) [LS-CR45-PD WHITE](#) [5V 1A](#) [PB2 BLUE](#) [SC1](#) [SC2](#) [X4](#) [CEF14](#) [2XAA](#) [2XAAA](#) [CEF27](#) [2XAA](#) [2XAAA](#) [CL14.4VDC-0.4A](#) [CL14.4VDC-0.7A](#) [CL14.4VDC-1.2A](#) [CL7.2VDC-0.4A](#) [CL7.2VDC-0.7A](#) [CL7.2VDC-1.2A](#) [C2](#) [L2 PLUS](#)