



(Cable connection)



(USB connection)

ANSI/AAMI ES60601-1  
 ES60601-1-11  
 EN60601-1  
 EN60601-1-11  
 (except for GEM06I05-USB)

### ■ Features

- Interchangeable AC plugs (plug kit sold separately)
- Medical safety approved (2 x MOPP) according to ANSI/AAMI ES60601-1/ES60601-1-11, EN60601-1/EN60601-1-11
- Extremely low leakage current
- No load power consumption < 0.3W
- **Energy efficiency Level V**
- -20~+70°C wide range working temperature
- Class II power (no earth pin)
- Protections: Short circuit / Overload / Over voltage
- Fully enclosed plastic case
- 3 years warranty

### ■ Applications

- Blood glucose meter
- Blood pressure meter
- Nebulizer
- Inhaler
- Portable medical device
- Sleep apnea devices

### ■ Description

GEM06I is a highly reliable, 6W wall-mounted style single-output green medical adaptor series, which is compact and convenient for carry. This product is equipped with an interchangeable AC plug (4 types, including European type, USA type, U.K. type and Australian type) that makes it very suitable for businessmen to use in the major countries around the globe. GEM06I is a class II power unit (no FG), accepting the input range from 80VAC to 264VAC that it can satisfy the demands for various types of medical electrical devices. The circuitry design meets the international medical standards (2\*MOPP), having an ultra low leakage current (<55µA), fitting the medical devices in direct electrical contact with the patients.

With the working efficiency up to 80% and the extremely low no-load power consumption below 0.3W, GEM06I is compliant with the latest USA energy regulation EISA 2007/DoE (Level V) and EU ErP. The supreme feature allows the adaptor to save the energy when it is under either the operating mode or the standby mode. The entire series is approved for international safety regulations; moreover, it adopts the 94V-0 flame retardant plastic case that it can effectively prevent users from electric hazard.

### ■ Model Encoding

**GEM06 I 05 -P1J**

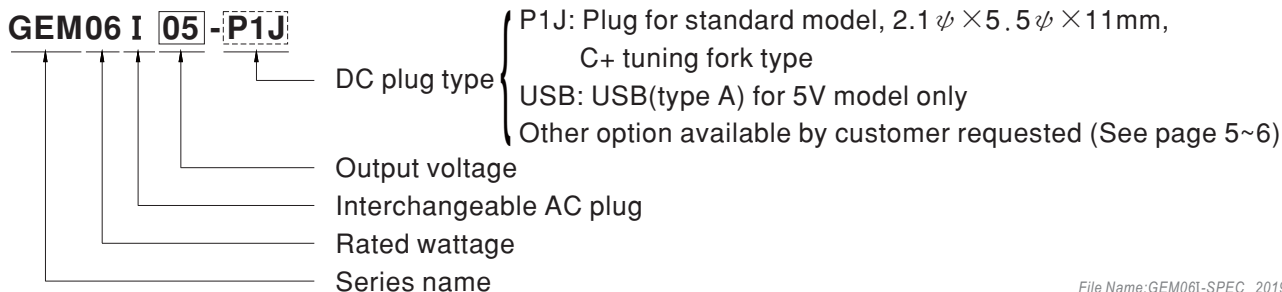

Interchangeable AC plug Specifically for GEM06I/12I/18I/30I/40I/60I

TYPE					
	Australian type	U.K type	European type	US type	Mix four type
ORDER NO.	AC plug-AU2	AC plug-UK2	AC plug-EU2	AC plug-US2	AC plug-MIX2

**SPECIFICATION**

ORDER NO.	GEM06I05-□ □=P1J USB	GEM06I06-P1J	GEM06I07-P1J	GEM06I09-P1J	GEM06I12-P1J	GEM06I15-P1J	GEM06I18-P1J	GEM06I24-P1J		
OUTPUT	SAFETY MODEL NO.	GEM06I05	GEM06I06	GEM06I07	GEM06I09	GEM06I12	GEM06I15	GEM06I18	GEM06I24	
	DC VOLTAGE <small>Note.2</small>	5V	6V	7.5V	9V	12V	15V	18V	24V	
	RATED CURRENT	1.2A	1A	0.8A	0.66A	0.5A	0.4A	0.33A	0.25A	
	CURRENT RANGE	0 ~ 1.2A	0 ~ 1A	0 ~ 0.8A	0 ~ 0.66A	0 ~ 0.5A	0 ~ 0.4A	0 ~ 0.33A	0 ~ 0.25A	
	RATED POWER (max.)	6W	6W	6W	6W	6W	6W	6W	6W	
	RIPPLE & NOISE (max.) <small>Note.3</small>	50mVp-p	50mVp-p	80mVp-p	80mVp-p	100mVp-p	120mVp-p	150mVp-p	180mVp-p	
	VOLTAGE TOLERANCE <small>Note.4</small>	±5.0%	±5.0%	±5.0%	±5.0%	±5.0%	±5.0%	±5.0%	±4.0%	
	LINE REGULATION <small>Note.5</small>	±0.5%	±0.5%	±0.5%	±0.5%	±0.5%	±0.5%	±0.5%	±0.5%	
LOAD REGULATION <small>Note.6</small>	±5.0%	±5.0%	±5.0%	±5.0%	±3.0%	±3.0%	±3.0%	±2.0%		
SETUP, RISE, HOLD UP TIME	1000ms, 50ms, 12ms at full load									
INPUT	VOLTAGE RANGE <small>Note.7</small>	80 ~ 264VAC		113 ~ 370VDC						
	FREQUENCY RANGE	47 ~ 63Hz								
	EFFICIENCY (Typ.)	70%	74%	74%	76%	76%	79%	79%	80%	
	AC CURRENT	0.18A / 100VAC								
	INRUSH CURRENT (max.)	Cold start 15A/ 115VAC 30A / 230VAC								
LEAKAGE CURRENT(max.)	Touch current < 55µA/264VAC									
PROTECTION	OVERLOAD	>105% rated output power Protection type : Hiccup mode, recovers automatically after fault condition is removed								
	OVER VOLTAGE	110 ~ 140% rated output power Protection type : Clamp by zener diode								
ENVIRONMENT	WORKING TEMP.	-20 ~ +70°C(Refer to "Derating Curve")								
	WORKING HUMIDITY	20% ~ 90% RH non-condensing								
	STORAGE TEMP., HUMIDITY	-20 ~ +85°C, 10 ~ 95% RH non-condensing								
	TEMP. COEFFICIENT	±0.04% / °C (0 ~ 50°C)								
	VIBRATION	10 ~ 500Hz, 2G 10min./1cycle, period for 60min. each along X, Y, Z axes								
SAFETY & EMC <small>(Note. 8)</small>	SAFETY STANDARDS	TUV EN60601-1/EN60601-1-11,ANSI/ AAMI ES60601-1/ES60601-1-11(3.1 version), CAN/CSA-C22 3 <sup>rd</sup> edition, EAC TP TC 004 approved GEM06I05-USB without EN60601-1-11 , ANSI/ AAMII ES60601-1-11								
	ISOLATION LEVEL	Primary - Secondary: 2 x MOPP								
	WITHSTAND VOLTAGE	I/P-O/P:5656VDC								
	ISOLATION RESISTANCE	I/P-O/P:100M Ohms / 500VDC / 25°C/ 70% RH								
	EMC EMISSION	Parameter	Standard			Test Level / Note				
		Conducted emission	EN55011 (CISPR11),FCC PART 15 and 18/ CISPR22			Class B				
		Radiated emission	EN55011 (CISPR11),FCC PART 15 and 18/ CISPR22			Class B				
		Harmonic current	EN61000-3-2			Class A				
	Voltage flicker	EN61000-3-3			-----					
	EMC IMMUNITY	EN55024 , EN60601-1-2, EN61204-3								
		Parameter	Standard			Test Level / Note				
		ESD	EN61000-4-2			Level 4, 15KV air ; Level 4, 8KV contact				
		RF field susceptibility	EN61000-4-3			Level 3, 10V/m(80MHz~2.7GHz) Table 9, 9~28V/m(385MHz~5.78GHz)				
EFT bursts		EN61000-4-4			Level 3, 2KV					
Surge susceptibility		EN61000-4-5			Level 3, 1KV/Line-Line					
Conducted susceptibility		EN61000-4-6			Level 2, 3V					
Magnetic field immunity		EN61000-4-8			Level 4, 30A/m					
Voltage dip, interruption	EN61000-4-11			>95% dip 0.5 periods, 30% dip 25 periods, >95% interruptions 250 periods						
OTHERS	LIFE	3 years (12 hrs per day for 5V output)								
	MTBF	500Khrs min. MIL-HDBK-217F(25°C)								
	DIMENSION	73.9*39*48.5mm (L*W*H)								
	PACKING	101g ; 72pcs / 8.3kg / CARTON for cable connection; 72g ; 150pcs / 11.8kg / CARTON for USB connection								
CONNECTOR	PLUG	See page 5-6 ; other type available by customer requested								
	CABLE	See page 5-6 ; other type available by customer requested								
NOTE	<p>1.All parameters are specified at 230VAC input, rated load, 25°C 70% RH ambient.</p> <p>2.DC voltage: The output voltage set at point measure by plug terminal &amp; 50% load.</p> <p>3.Ripple &amp; noise are measured at 20MHz by using a 12" twisted pair terminated with a 0.1µf &amp; 47µf capacitor.</p> <p>4.Tolerance: includes set up tolerance, line regulation, load regulation.</p> <p>5.Line regulation is measured from low line to high line at rated load.</p> <p>6.Load regulation is measured from 10% to 100% rated load.</p> <p>7.Derating may be needed under low input voltage. Please check the derating curve for more details.</p> <p>8.The power supply is considered as an independent unit, but the final equipment still need to re-confirm that the whole system complies with the EMC directives. For guidance on how to perform these EMC tests, please refer to "EMI testing of component power supplies." (as available on <a href="http://www.meanwell.com">http://www.meanwell.com</a>)</p>									

### Derating Curve

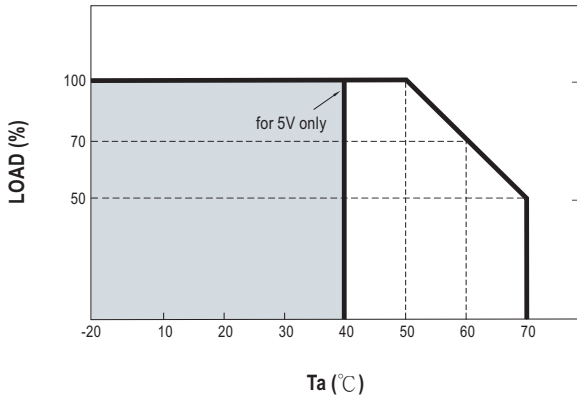

### Static Characteristics

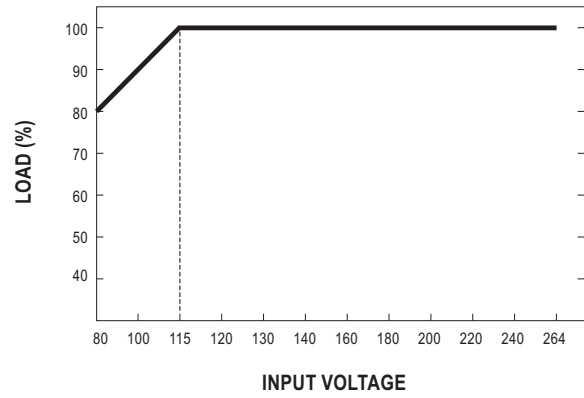

### Mechanical Specification

Unit:mm

TYPE	Australian type	U.K type	European type	US type

### ※Cable connection

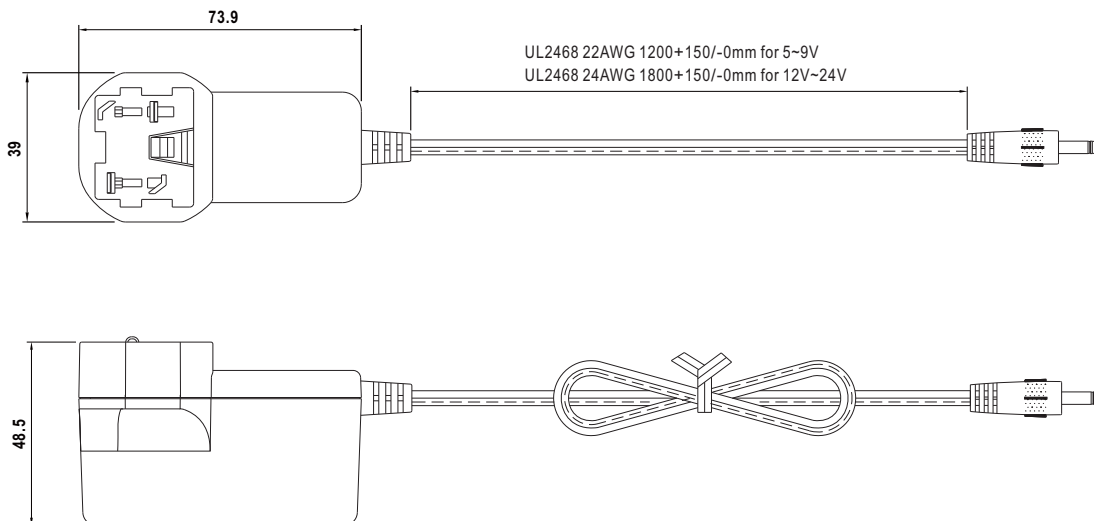

※USB connection

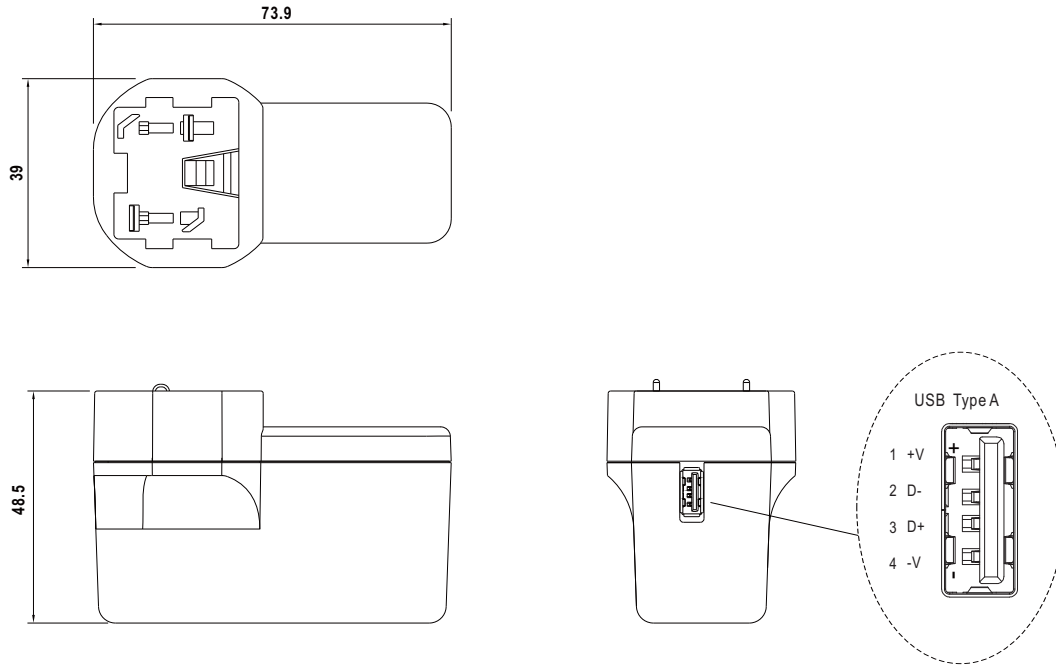











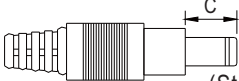
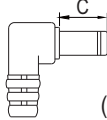

■ DC output plug

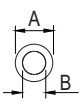
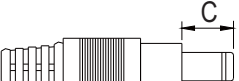
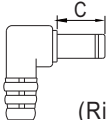

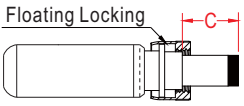
Standard plug: P1J

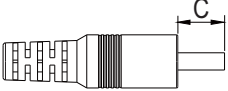
Unit:mm

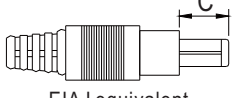
P1J	Pin Assignment
	<p>⊕ C<sup>+</sup> ⊕</p> <p>Outside ⊖ ⊕ Inside</p>

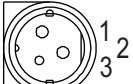
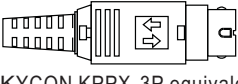
© Optional DC plug:

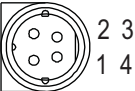
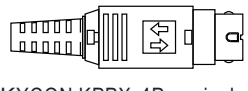
Tuning Fork Style		Type No.	A	B	C	
			OD	ID	L	
 	 (Straight)	P1I	5.5	2.1	9.5	
		P1L	5.5	2.5	9.5	
		P1M	5.5	2.5	11.0	
	 (Right-angled)	P1IR	5.5	2.1	9.5	
		P1JR	5.5	2.1	11.0	
		P1LR	5.5	2.5	9.5	
		P1MR	5.5	2.5	11.0	
Barrel Style		Type No.	A	B	C	
			OD	ID	L	
 	 (Straight)	P2I	5.5	2.1	9.5	
		P2J	5.5	2.1	11.0	
		P2L	5.5	2.5	9.5	
		P2M	5.5	2.5	11.0	
	 (Right-angled)	P2IR	5.5	2.1	9.5	
		P2JR	5.5	2.1	11.0	
		P2LR	5.5	2.5	9.5	
		P2MR	5.5	2.5	11.0	
Lock Style		Type No.	A	B	C	
			OD	ID	L	
   SWITCHCRAFT original or equivalent	P2S(S761K)	5.53	2.03	12.06		
		P2K(761K)	5.53	2.54	12.06	
		P2C(S760K)	5.53	2.03	9.52	
		P2D(760K)	5.53	2.54	9.52	
Min. Pin Style		Type No.	A	B	C	
			OD	ID	L	
  	P3A	2.35	0.7	11.0		
		P3B	4.0	1.7	11.0	
		P3C	4.75	1.7	11.0	
Center Pin Style		Type No.	A	B	C	D
			OD	ID	L	Center Pin
  	P4A	5.5	3.4	11.0	1.0	
		P4B	6.5	4.4	11.0	1.4
		P4C	7.4	5.1	11.0	0.6
Min. DIN 3 Pin with Lock (male)		Type No.	Pin Assignment			
			PIN No.	Output		
  	R6B	1	+Vo			
			2	-Vo		
			3	+Vo		

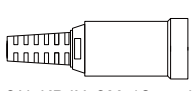
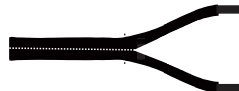
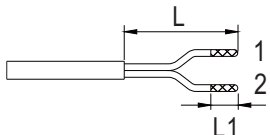
Min. DIN 4 Pin with Lock (male)	Type No.	Pin Assignment	
		PIN No.	Output
   <p>KYCON KPPX-4P equivalent</p>	R7B	1	+Vo
		2	-Vo
		3	-Vo
		4	+Vo
Min. DIN 4 Pin with Lock (female)	Type No.	Pin Assignment	
		PIN No.	Output
   <p>KYCON KPJX-CM-4S equivalent</p>	R7BF	1	+Vo
		2	-Vo
		3	-Vo
		4	+Vo
Stripped and tinned leads	Type No.	Pin Assignment	
		PIN No.	Output
  <p>Length of Land L1 by request (MW's standard length, L: <u>25</u> mm, L1: <u>10</u> mm)</p>	by customer	1 (Ribbed)	+Vo
		2 (Letter)	-Vo

■ **Installation Manual**

Please refer to : <http://www.meanwell.com/manual.html>

## X-ON Electronics

Largest Supplier of Electrical and Electronic Components

*Click to view similar products for [Wall Mount AC Adapters](#) category:*

*Click to view products by [Mean Well](#) manufacturer:*

Other Similar products are found below :

[ADP-163 E](#) [ADP-167 J](#) [ADP-159 A](#) [PSAC05A-050L6](#) [DA10-050US](#) [WSU075-1000-R13](#) [WSU120-2000-R13](#) [WSU180-1330-13](#) [WSU120-2000-13](#) [WSU150-0800-13](#) [WSU075-3200-13](#) [WSU090-2500-13](#) [WSU050-2000-R13](#) [WSU240-1000-13](#) [WSU150-0560-13](#) [WSU240-0500-R13](#) [WSU075-1500-13](#) [WSU050-3000-13](#) [WSU120-1500-13](#) [WSU120-1500-R13](#) [WSU240-0750-13](#) [WSU180-0660-13](#) [WSU090-1300-13](#) [WSU050-1500-13](#) [WSU090-0800-13](#) [WSU120-0700-13](#) [WSU120-3000-13](#) [WSU090-1300-R13](#) [WSU075-1000-13](#) [WSU060-1250-13](#) [WSU050-4000-13](#) [WSU045-1500-R13](#) [PSAC05A-050L6M](#) [AC PLUG-AU3](#) [AC PLUG-MIX3](#) [TRE-A](#) [223-00011](#) [223-00012](#) [AA20R-480A-R](#) [223-00010](#) [KT1001US](#) [BB-SMI6B12V-P230C1](#) [FPBAG1-H](#) [KT1001EU](#) [POSC05200A-0723-WH](#) [POSC05200A-1335-WH](#) [POSC05200A-1740](#) [POSC05200A-CN-WH](#) [POSC12100A-0723](#) [POSC12100A-1335-WH](#)