

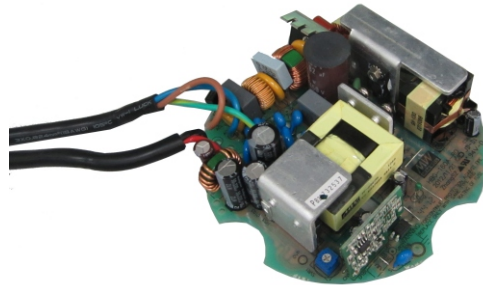

# 160W Constant Voltage + Constant Current LED Driver **HBG-160P** series



## ■ Features

- Constant Voltage + Constant Current mode output
- Circular shape PCB type design
- Built-in active PFC function
- Function options: output adjustable via potentiometer; 3 in 1 dimming; DALI
- Typical lifetime > 50000 hours
- 5 years warranty

## ■ Applications

- LED bay lighting
- LED down lighting
- LED spot lighting
- LED mining lighting
- LED stage lighting

## ■ Description

HBG-160P series is a 160W AC/DC PCB type LED driver featuring the circular shape design. It operates from 90~305VAC and offers the dual mode constant voltage and constant current output models with different rated voltage ranging between 36V and 60V. Thanks to the high efficiency up to 93.5%, with the fanless design, the entire series is able to operate for -40°C ~ +45°C under free air convection. HBG-160P is equipped with various function options, such as dimming methodology, so as to provide the optimal design flexibility for LED lighting system.

## ■ Model Encoding

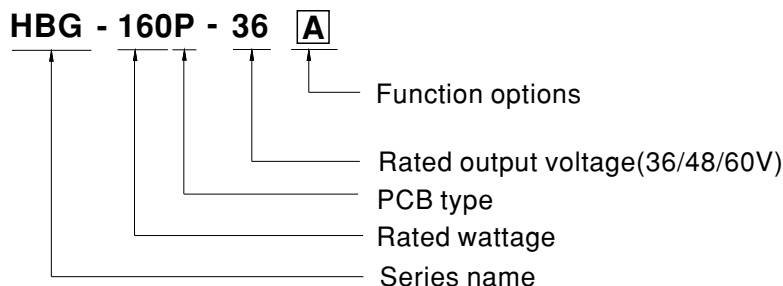

| Type | Function   | Note     |
|------|--|----------|
| A    | Io adjustable through built-in potentiometer.                    | In Stock |
| B    | 3 in 1 dimming function (1~10Vdc, 10V PWM signal and resistance) | In Stock |
| DA   | DALI control technology.   | In Stock |



# 160W Constant Voltage + Constant Current LED Driver **HBG-160P** series

## SPECIFICATION

| MODEL                                   |   | HBG-160P-36 <input type="checkbox"/>  | HBG-160P-48 <input type="checkbox"/> | HBG-160P-60 <input type="checkbox"/> |
|---|---|---|--------------------------------------|--------------------------------------|
| OUTPUT                                  | DC VOLTAGE  | 36V   | 48V                                  | 60V                                  |
|   | CONSTANT CURRENT REGION <small>Note.2</small>   | 21.6 ~ 36V  | 28.8 ~ 48V                           | 36 ~ 60V                             |
|   | RATED CURRENT   | 4.4A  | 3.3A                                 | 2.6A                                 |
|   | RATED POWER <small>Note.5</small>   | 158.4W  | 158.4W                               | 156W                                 |
|   | RIPPLE & NOISE (max.) <small>Note.3</small>   | 300mVp-p  | 300mVp-p                             | 300mVp-p                             |
|   | CURRENT ADJ. RANGE  | Adjustable for A-Type only (via built-in potentiometer)   |                                      |                                      |
|   |   | 2.6 ~ 4.4A  | 1.98 ~ 3.3A                          | 1.6 ~ 2.6A                           |
|   | VOLTAGE TOLERANCE <small>Note.4</small>   | ±2.0%   |                                      |                                      |
|   | LINE REGULATION   | ±0.5%   |                                      |                                      |
|   | LOAD REGULATION   | ±1.0%   |                                      |                                      |
| SETUP, RISE TIME <small>Note.6</small>  | 2500ms, 200ms / 115VAC  | 500ms, 200ms / 230VAC   |                                      |                                      |
| HOLD UP TIME (Typ.)                     | 12ms/115VAC, 230VAC   |   |                                      |                                      |
| INPUT                                   | VOLTAGE RANGE <small>Note.5</small>   | 90 ~ 305VAC    127 ~ 431VDC<br>(Please refer to "STATIC CHARACTERISTIC" section)  |                                      |                                      |
|   | FREQUENCY RANGE   | 47 ~ 63Hz   |                                      |                                      |
|   | POWER FACTOR  | PF ≥ 0.98/115VAC, PF ≥ 0.95/230VAC, PF ≥ 0.92/277VAC@full load<br>(Please refer to "POWER FACTOR (PF) CHARACTERISTIC" section)    |                                      |                                      |
|   | TOTAL HARMONIC DISTORTION   | THD < 20% (@load ≥ 60%/115VAC, 230VAC; @load ≥ 75%/277VAC)<br>(Please refer to "TOTAL HARMONIC DISTORTION(THD)" section)          |                                      |                                      |
|   | EFFICIENCY (Typ.) <small>Note.7</small>   | 92%   | 93%                                  | 93.5%                                |
|   | AC CURRENT  | 1.7A / 115VAC   | 0.78A / 230VAC                       | 0.7A / 277VAC                        |
|   | INRUSH CURRENT(Typ.)  | COLD START 65A(twidth=550μs measured at 50% Ipeak) at 230VAC; Per NEMA 410  |                                      |                                      |
|   | MAX. No. of PSUs on 16A CIRCUIT BREAKER   | 4 units (circuit breaker of type B) / 7 units (circuit breaker of type C) at 230VAC   |                                      |                                      |
| LEAKAGE CURRENT                         | <0.75mA / 277VAC  |   |                                      |                                      |
| PROTECTION                              | OVER CURRENT  | 95 ~ 108%<br>Constant current limiting, recovers automatically after fault condition is removed                                   |                                      |                                      |
|   | OVER VOLTAGE  | 41 ~ 47V  | 54 ~ 62V                             | 65 ~ 75V                             |
|   |   | Protection type : Shut down o/p voltage with auto-recovery or re-power on to recovery   |                                      |                                      |
| OVER TEMPERATURE <small>Note.13</small> | Shut down o/p voltage, recovers automatically after temperature goes down   |   |                                      |                                      |
| ENVIRONMENT                             | WORKING TEMP.   | Ta=-40 ~ +45°C (Please refer to " OUTPUT LOAD vs TEMPERATURE" section)  |                                      |                                      |
|   | WORKING HUMIDITY  | 20 ~ 95% RH non-condensing  |                                      |                                      |
|   | STORAGE TEMP., HUMIDITY   | -40 ~ +80°C, 10 ~ 95% RH  |                                      |                                      |
|   | TEMP. COEFFICIENT   | ±0.03%/°C (0 ~ 45°C)  |                                      |                                      |
|   | VIBRATION   | 10 ~ 500Hz, 2G 12min./1cycle, period for 72min. each along X, Y, Z axes   |                                      |                                      |
| SAFETY & EMC                            | SAFETY STANDARDS  | UL8750, CSA C22.2 No.250.13-12; IEC62384, EN61347-1, EN61347-2-13, EN62384, GB19510.1, GB19510.14, EAC TP TC 004 approved         |                                      |                                      |
|   | DALI STANDARDS  | Compliance to IEC62386-101, 102, 207 for DA-Type only   |                                      |                                      |
|   | WITHSTAND VOLTAGE   | I/P-O/P:3.75KVAC I/P-FG:2KVAC O/P-FG:0.5KVAC  |                                      |                                      |
|   | ISOLATION RESISTANCE  | I/P-O/P, I/P-FG, O/P-FG:100M Ohms / 500VDC / 25°C / 70% RH  |                                      |                                      |
|   | EMC EMISSION  | Compliance to EN55015, EN61000-3-2 Class C (@load ≥60%) ; EN61000-3-3, GB17743, GB17625.1, EAC TP TC 020                          |                                      |                                      |
|   | EMC IMMUNITY  | Compliance to EN61000-4-2,3,4,5,6,8,11, EN61547, light industry level(surge immunity:Line-Earth:4KV,Line-Line:2KV), EAC TP TC 020 |                                      |                                      |
| OTHERS                                  | MTBF  | 195.5Khrs min. MIL-HDBK-217F (25°C)   |                                      |                                      |
|   | DIMENSION   | Refer to mechanical specification   |                                      |                                      |
|   | PACKING   | 0.4Kg; 36pcs/15.4Kg/1.35CUFT  |                                      |                                      |
| NOTE                                    | <ol style="list-style-type: none"> <li>All parameters NOT specially mentioned are measured at 230VAC input, rated current and 25°C of ambient temperature.</li> <li>Please refer to "DRIVING METHODS OF LED MODULE".</li> <li>Ripple &amp; noise are measured at 20MHz of bandwidth by using a 12" twisted pair-wire terminated with a 0.1uf &amp; 47uf parallel capacitor.</li> <li>Tolerance : includes set up tolerance, line regulation and load regulation.</li> <li>De-rating may be needed under low input voltages. Please refer to "STATIC CHARACTERISTIC" sections for details.</li> <li>Length of set up time is measured at first cold start. Turning ON/OFF the driver may lead to increase of the set up time.</li> <li>The DA type power supply is less efficient than the typical efficiency in specification by 1%.</li> <li>The driver is considered as a component that will be operated in combination with final equipment. Since EMC performance will be affected by the complete installation, the final equipment manufacturers must re-qualify EMC Directive on the complete installation again.</li> <li>To fulfill requirements of the latest ErP regulation for lighting fixtures, this LED driver can only be used behind a switch without permanently connected to the mains.</li> <li>This series meets the typical life expectancy of &gt;50,000 hours of operation when Ta is about 45°C or less.</li> <li>Please refer to the warranty statement on MEAN WELL's website at <a href="http://www.meanwell.com">http://www.meanwell.com</a></li> <li>The ambient temperature derating of 3.5°C/1000m with fanless models and of 5°C/1000m with fan models for operating altitude higher than 2000m(6500ft).</li> <li>All functional testing must be filled with potting, including OTP function .</li> </ol> |   |                                      |                                      |

## ■ BLOCK DIAGRAM

fosc : 100KHz

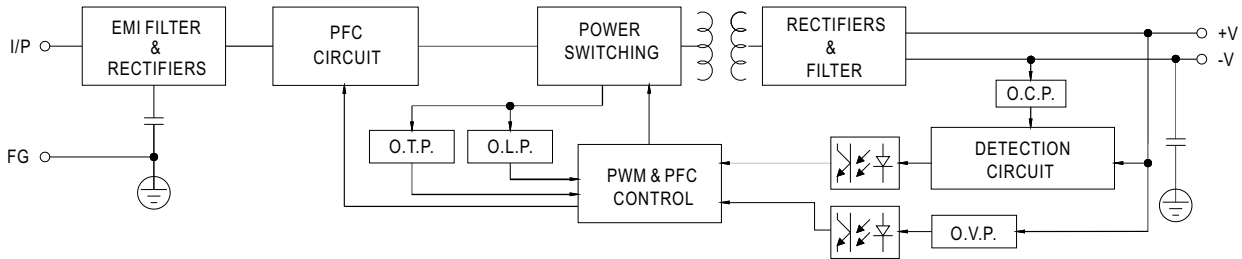

## ■ DRIVING METHODS OF LED MODULE

- ※ This series is able to work in either Constant Current mode (a direct drive way) or Constant Voltage mode (usually through additional DC/DC driver) to drive the LEDs.

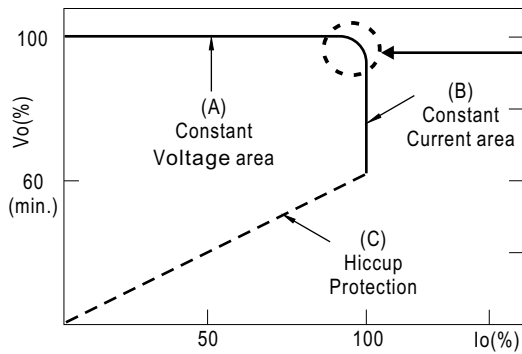

Typical output current normalized by rated current (%)

In the constant current region, the highest voltage at the output of the driver depends on the configuration of the end systems.  
Should there be any compatibility issues, please contact MEAN WELL.

## ■ DIMMING OPERATION

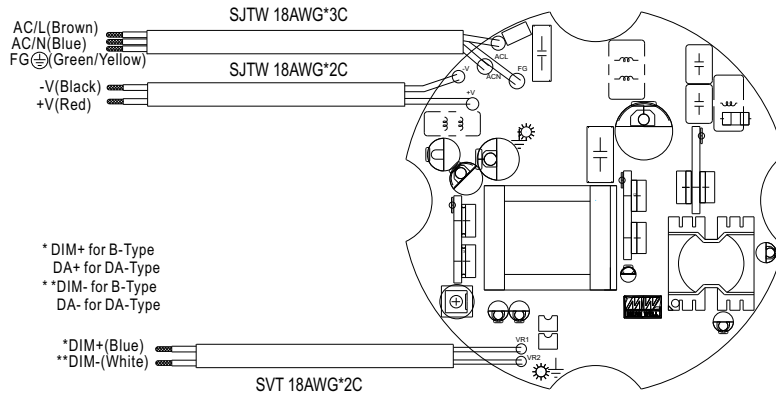

### ※ 3 in 1 dimming function (for B-Type)

- Output constant current level can be adjusted by applying one of the three methodologies between DIM+ and DIM-:  
1 ~ 10VDC, or 10V PWM signal or resistance.
- Direct connecting to LEDs is suggested. It is not suitable to be used with additional drivers.
- Dimming source current from power supply: 100 $\mu$ A (typ.)

#### ◎ Applying additive 1 ~ 10VDC

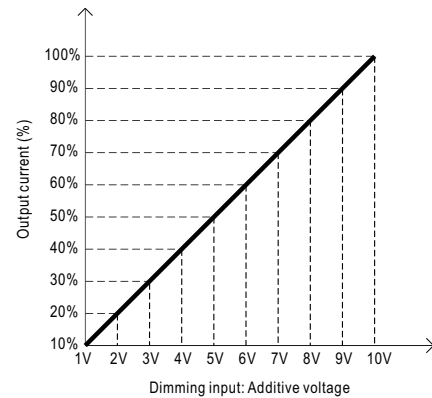
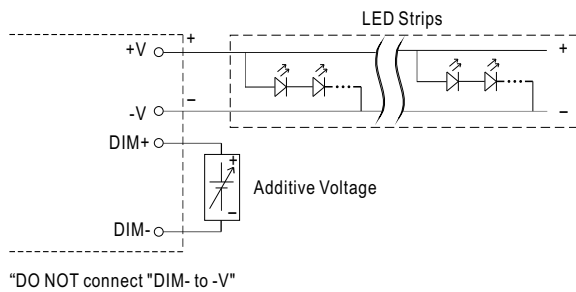

#### ◎ Applying additive 10V PWM signal (frequency range 100Hz ~ 3KHz):

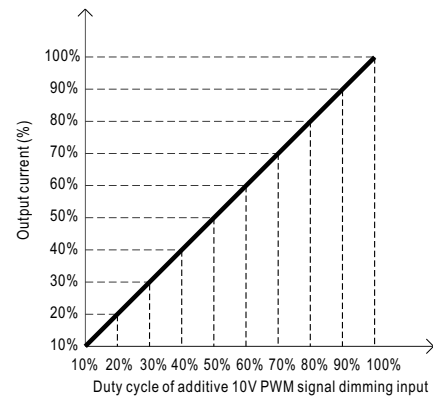
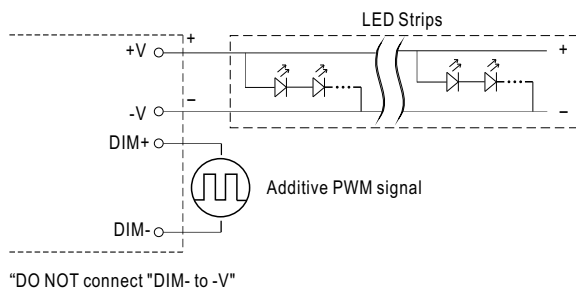

◎ Applying additive resistance:

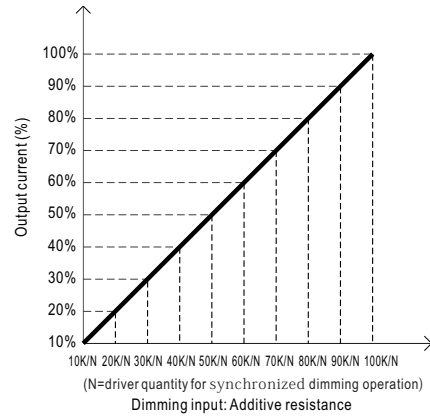
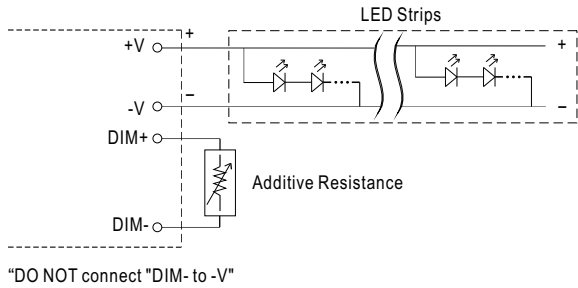

Note: In the case of turning the lighting fixture down to 0% brightness, please refer to the configuration as follow, or please contact MEAN WELL for other options.

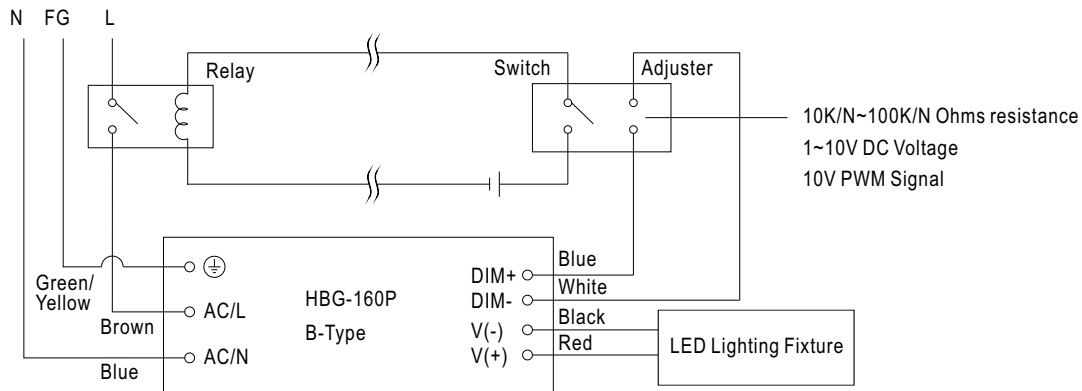

Using a switch and relay can turn ON/OFF the lighting fixture.

※ **DALI Interface (primary side; for DA-Type)**

- Apply DALI signal between DA+ and DA-.
- DALI protocol comprises 16 groups and 64 addresses.
- First step is fixed at 8% of output.

## OUTPUT LOAD vs TEMPERATURE

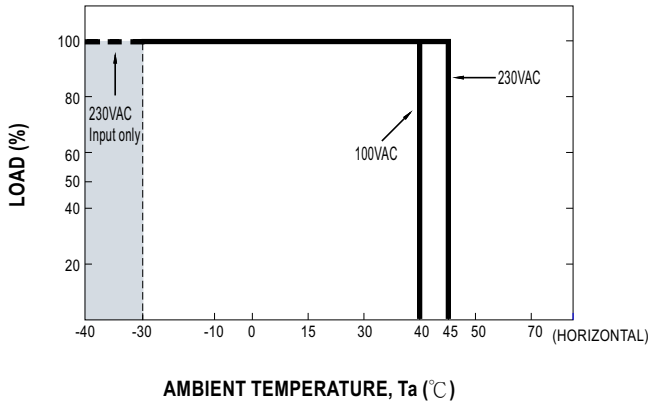

## STATIC CHARACTERISTIC

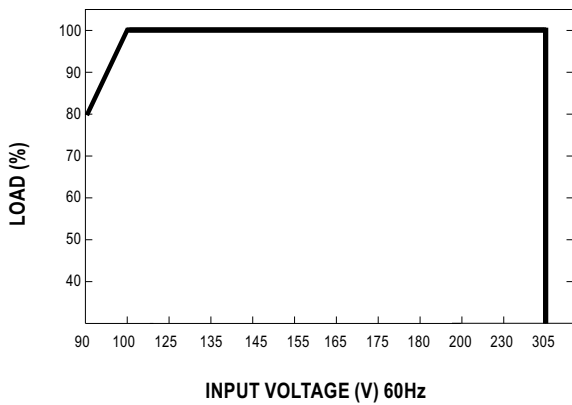

※ De-rating is needed under low input voltage.

## POWER FACTOR (PF) CHARACTERISTIC

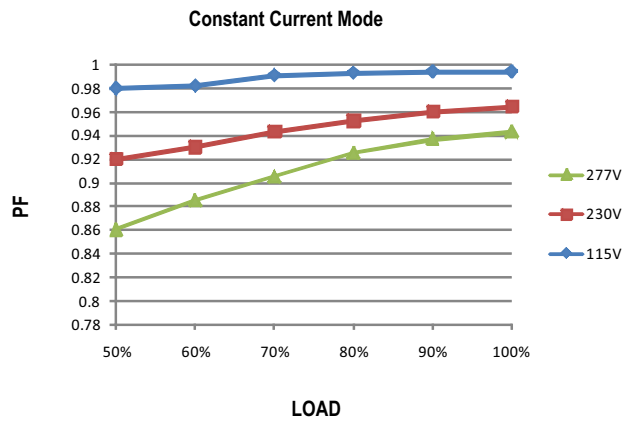

## TOTAL HARMONIC DISTORTION (THD)

※ 48V Model

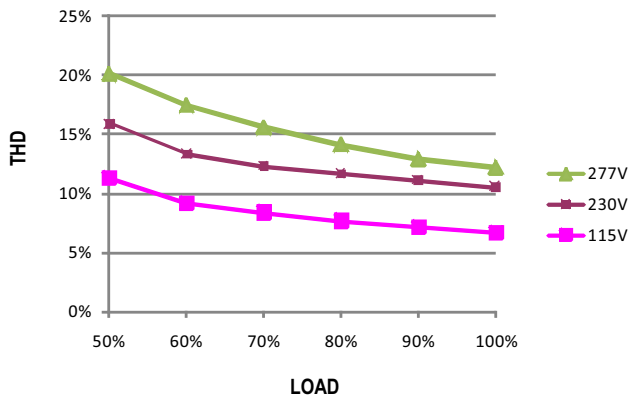

## EFFICIENCY vs LOAD

HBG-160P series possess superior working efficiency that up to 93.5% can be reached in field applications.

※ 48V Model

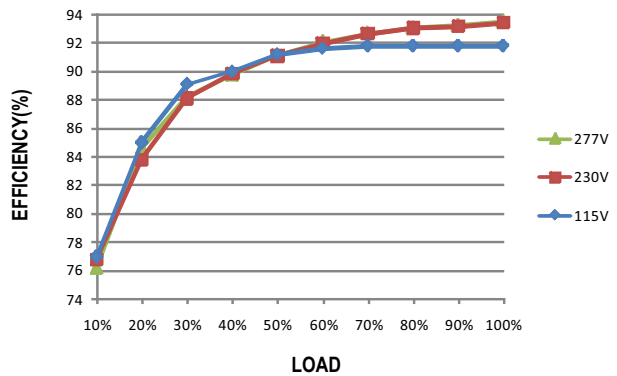

## MECHANICAL SPECIFICATION

### ※ A type

Unit:mm

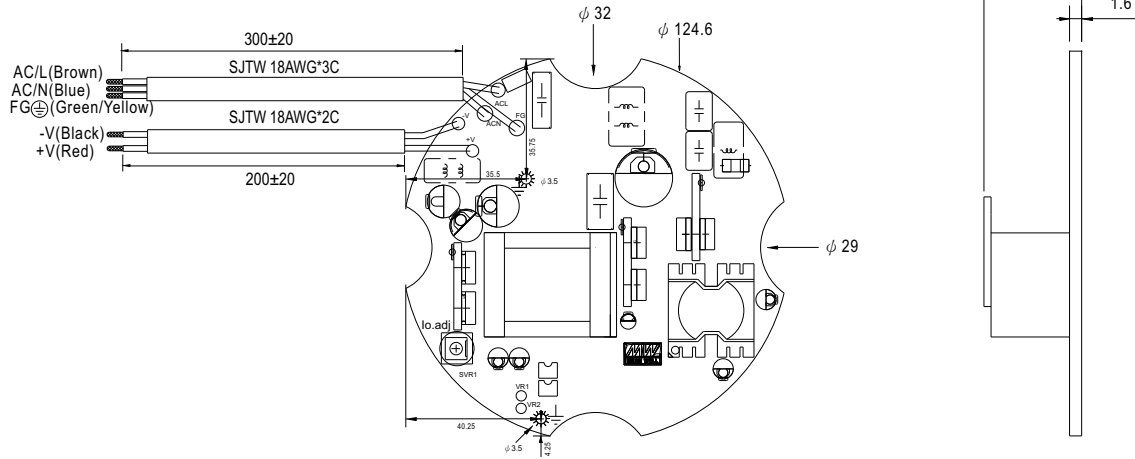

### ※ B/DA type

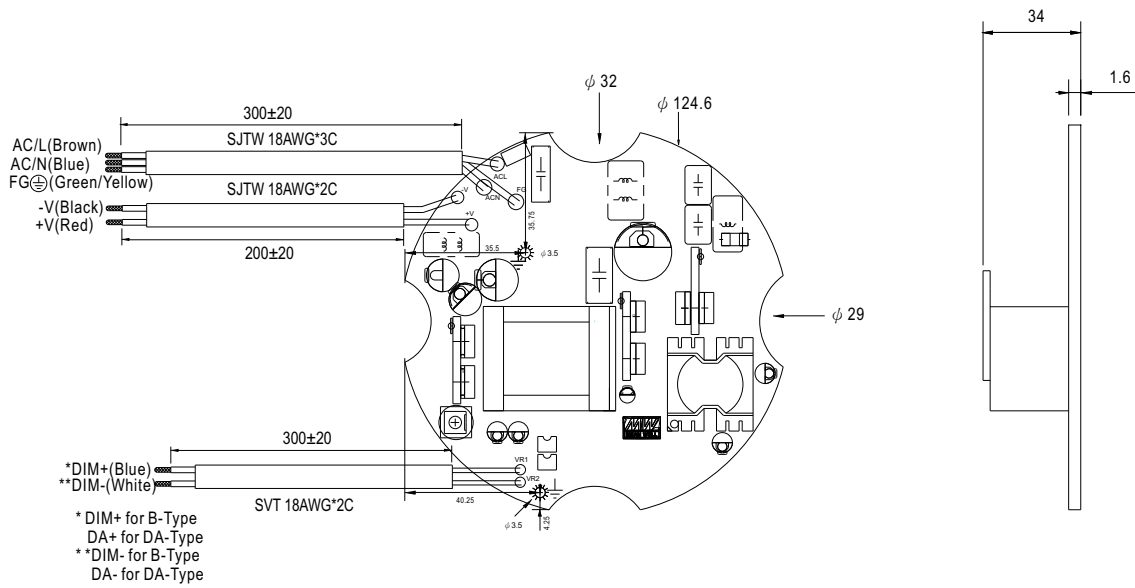

## X-ON Electronics

Largest Supplier of Electrical and Electronic Components

*Click to view similar products for [LED Power Supplies](#) category:*

*Click to view products by [Mean Well](#) manufacturer:*

Other Similar products are found below :

[ESS015W-1000-12](#) [PDA-WIFI](#) [PIFC-K250F](#) [PITB-K222A](#) [ALD-514012PJ134](#) [LB240S24KH](#) [LMH020-SPLC-0000-0000001](#) [79534](#) [79535](#)  
[EUG-200S210DT](#) [ESS030W-1050-21](#) [ESS030W-0900-32](#) [BPOXL 4-12-035](#) [ESS010W-0350-24](#) [ESM060W-1400-42](#) [PDA080B-1A0G](#)  
[PDA150B-S1A5G](#) [SLM140W-1.05-130-ZA](#) [ESS015W-0700-18](#) [EUD-150S350DVA](#) [LWA320-C420-ARK-B](#) [HVG-240-48AB](#) [HVG-320-](#)  
[36AB](#) [HVG-320-54AB](#) [ELG-240-C1400AB](#) [EUK-150S105DV](#) [BXCS-12Z-N2P-B1-A](#) [BXPR-WN-01-A](#) [BXCS-12D-N2P-01-A](#) [BXCS-](#)  
[12W-N2P-01-A](#) [HLG-185H-C1400AB](#) [980100001200394](#) [LC 14W 250-350MA FLEXC R ADV2](#) [LC 24W 500-600MA FLEXC R ADV2](#)  
[LC 36W 850-900MA FLEXC R ADV2](#) [LC 50W 200-350ML 170V FLEXC LP SNC4](#) [LC 25W 200-350ML 70V FLEXC LP SNC4](#) [LC 35W](#)  
[200-350ML 121V FLEXC LP SNC4](#) [LCBI 10W 350MA PHASE-CUT/1-10V LP](#) [LC 13W 300MA FIXC C SNC](#) [LC 10W 250MA FIXC SC](#)  
[SNC2](#) [LC 35W 800MA FIXC SR ADV2](#) [LC 38W 900MA FIXC SR ADV2](#) [LC 34W 800MA FIXC SC ADV2](#) [LC 44W 1050MA FIXC SC](#)  
[ADV2](#) [LC 38W 900MA 42V FIXC SRL ADV2](#) [HVG-320-48AB](#) [CNB50W-1200-42-CAS](#) [CNB30W-0600-42-CAS](#) [LCI 100W 1400MA TEC](#)

[C](#)