



■ Features :

- Universal AC input / Full range
- Built-in active PFC function, PF>0.95
- High efficiency up to 89.5%
- Withstand 300VAC surge input for 5 seconds
- Protections: Short circuit / Overload / Over voltage / Over temperature
- Built-in constant current limiting circuit
- Built-in cooling Fan ON-OFF control
- Built-in DC OK signal
- Built-in remote ON-OFF control
- Stand by 5V@0.3A
- Built-in remote sense function
- No load power consumption<0.5W (Note.7)
- 5 years warranty



SPECIFICATION

MODEL	HRPG-450-3.3	HRPG-450-5	HRPG-450-7.5	HRPG-450-12	HRPG-450-15	HRPG-450-24	HRPG-450-36	HRPG-450-48	
OUTPUT	DC VOLTAGE	3.3V	5V	7.5V	12V	15V	24V	36V	48V
	RATED CURRENT	90A	90A	60A	37.5A	30A	18.8A	12.5A	9.5A
	CURRENT RANGE	0 ~ 90A	0 ~ 90A	0 ~ 60A	0 ~ 37.5A	0 ~ 30A	0 ~ 18.8A	0 ~ 12.5A	0 ~ 9.5A
	RATED POWER	297W	450W	450W	450W	450W	451.2W	450W	456W
	RIPPLE & NOISE (max.) Note.2	80mVp-p	80mVp-p	100mVp-p	120mVp-p	150mVp-p	150mVp-p	240mVp-p	240mVp-p
	VOLTAGE ADJ. RANGE	2.8 ~ 3.8V	4.3 ~ 5.8V	6.8 ~ 9V	10.2 ~ 13.8V	13.5 ~ 18V	21.6 ~ 28.8V	28.8 ~ 39.6V	40.8 ~ 55.2V
	VOLTAGE TOLERANCE Note.3	± 2.0%	± 2.0%	± 2.0%	± 1.0%	± 1.0%	± 1.0%	± 1.0%	± 1.0%
	LINE REGULATION	± 0.5%	± 0.5%	± 0.5%	± 0.3%	± 0.3%	± 0.2%	± 0.2%	± 0.2%
	LOAD REGULATION	± 1.0%	± 1.0%	± 1.0%	± 0.5%	± 0.5%	± 0.5%	± 0.5%	± 0.5%
	SETUP, RISE TIME	1000ms, 100ms/230VAC 2500ms, 100ms/115VAC at full load							
HOLD UP TIME (Typ.)	16ms/230VAC 16ms/115VAC at full load								
INPUT	VOLTAGE RANGE Note.5	85 ~ 264VAC 120 ~ 370VDC							
	FREQUENCY RANGE	47 ~ 63Hz							
	POWER FACTOR (Typ.)	PF>0.95/230VAC PF>0.99/115VAC at full load							
	EFFICIENCY (Typ.)	80%	83%	86.5%	88%	89%	88%	89%	89.5%
	AC CURRENT (Typ.)	5A/115VAC 2.4A/230VAC							
	INRUSH CURRENT (Typ.)	35A/115VAC 70A/230VAC							
	LEAKAGE CURRENT	<1.5mA / 240VAC							
PROTECTION	OVERLOAD	105 ~ 135% rated output power Protection type : Constant current limiting, recovers automatically after fault condition is removed							
	OVER VOLTAGE	3.96 ~ 4.62V	6 ~ 7V	9.4 ~ 10.9V	14.4 ~ 16.8V	18.8 ~ 21.8V	30 ~ 34.8V	41.4 ~ 48.6V	57.6 ~ 67.2V
	OVER TEMPERATURE	Shut down o/p voltage, recovers automatically after temperature goes down							
FUNCTION	5V STANDBY	5VSB : 5V@0.3A ; tolerance ±5%, ripple : 50mVp-p(max.)							
	DC OK SIGNAL	PSU turn on : 3.3 ~ 5.6V ; PSU turn off : 0 ~ 1V							
	REMOTE CONTROL	RC+ / RC-: 4 ~ 10V or open = power on ; 0 ~ 0.8V or short = power off							
	FAN CONTROL (Typ.)	Load 20 ± 10% or RTH2 ≥ 50°C Fan on							
ENVIRONMENT	WORKING TEMP.	-40 ~ +70°C (Refer to "Derating Curve")							
	WORKING HUMIDITY	20 ~ 90% RH non-condensing							
	STORAGE TEMP., HUMIDITY	-40 ~ +85°C, 10 ~ 95% RH non-condensing							
	TEMP. COEFFICIENT	± 0.03%/°C (0 ~ 50°C)							
	VIBRATION	10 ~ 500Hz, 5G 10min./1cycle, 60min. each along X, Y, Z axes							
SAFETY & EMC (Note 4)	SAFETY STANDARDS	UL62368-1, TUV BS EN/EN62368-1, EAC TP TC 004 approved							
	WITHSTAND VOLTAGE	I/P-O/P:3KVAC I/P-FG:2KVAC O/P-FG:0.5KVAC							
	ISOLATION RESISTANCE	I/P-O/P, I/P-FG, O/P-FG:100M Ohms / 500VDC / 25°C / 70% RH							
	EMC EMISSION	Compliance to BS EN/EN55032 (CISPR32) Class B, BS EN/EN61000-3-2,-3, EAC TP TC 020							
	EMC IMMUNITY	Compliance to BS EN/EN61000-4-2,3,4,5,6,8,11, BS EN/EN55024, BS EN/EN61000-6-2, heavy industry level, criteria A, EAC TP TC 020							
OTHERS	MTBF	130.5K hrs min. MIL-HDBK-217F (25°C)							
	DIMENSION	218*105*41mm (L*W*H)							
	PACKING	1.19Kg; 12pcs/15.3Kg/0.82CUFT							

NOTE

1. All parameters NOT specially mentioned are measured at 230VAC input, rated load and 25°C of ambient temperature.
2. Ripple & noise are measured at 20MHz of bandwidth by using a 12" twisted pair-wire terminated with a 0.1uf & 47uf parallel capacitor.
3. Tolerance : includes set up tolerance, line regulation and load regulation.
4. The power supply is considered a component which will be installed into a final equipment. All the EMC tests are been executed by mounting the unit on a 360mm*360mm metal plate with 1mm of thickness. The final equipment must be re-confirmed that it still meets EMC directives. For guidance on how to perform these EMC tests, please refer to "EMI testing of component power supplies." (as available on <http://www.meanwell.com>)
5. Derating may be needed under low input voltages. Please check the derating curve for more details.
6. Length of set up time is measured at first cold start. Turning ON/OFF the power supply may lead to increase of the set up time.
7. No load power consumption<0.5W when RC- & RC+ (CN100 pin1,2) 0 ~ 0.8V or short.
8. The ambient temperature derating of 3.5°C/1000m with fanless models and of 5°C/1000m with fan models for operating altitude higher than 2000m(6500ft).

※ Product Liability Disclaimer : For detailed information, please refer to <https://www.meanwell.com/serviceDisclaimer.aspx>

Mechanical Specification

Case No. 995A Unit:mm

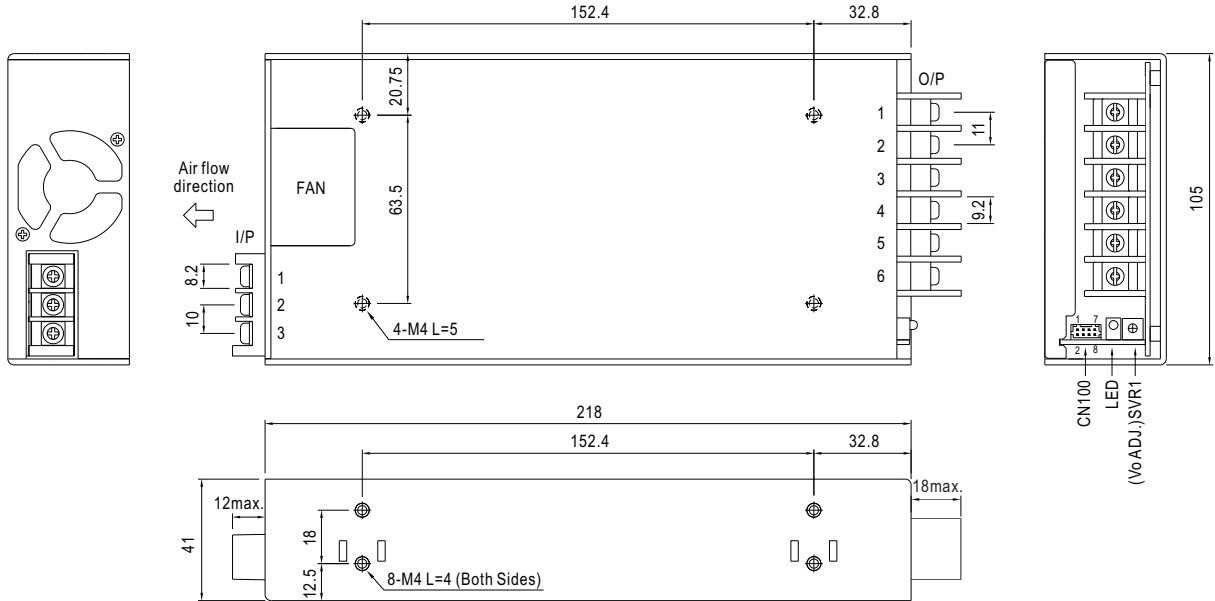

AC Input Terminal Pin No. Assignment

Pin No.	Assignment
1	AC/L
2	AC/N
3	FG \perp

DC Output Terminal Pin No. Assignment

Pin No.	Assignment
1~3	-V
4~6	+V

Connector Pin No. Assignment (CN100) : HRS DF11-8DP-2DS or equivalent

Pin No.	Assignment	Pin No.	Assignment	Mating Housing	Terminal
1	RC+	5	DC-OK	HRS DF11-8DS or equivalent	HRS DF11-**SC or equivalent
2	RC-	6	GND		
3	AUX	7	+S		
4	AUXG	8	-S		

Block Diagram

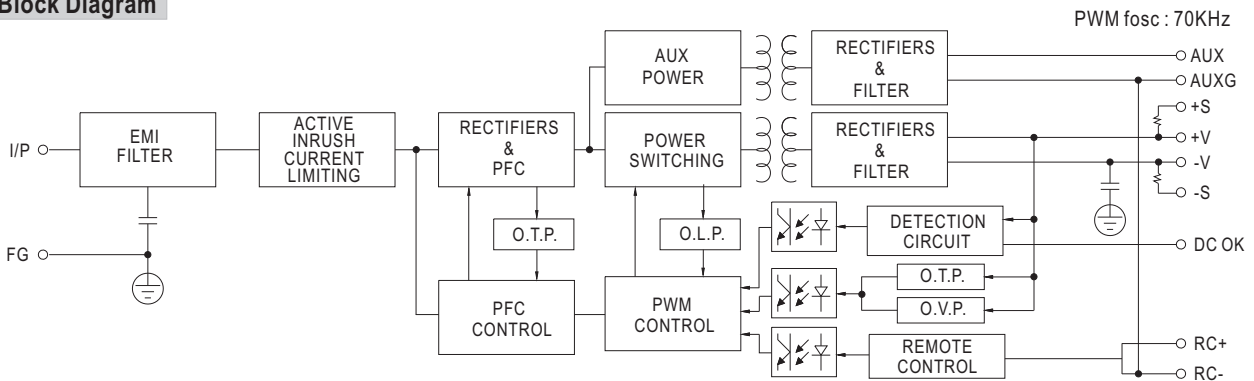

Derating Curve

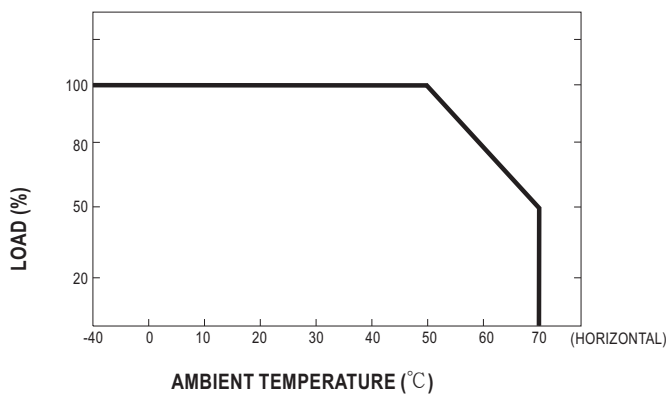

Output Derating VS Input Voltage

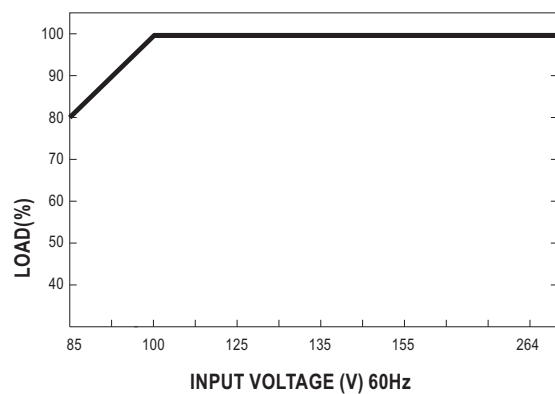

Function Description of CN100

Pin No.	Function	Description
1	RC+	Turns the output on and off by electrical or dry contact between pin 2 (RC-), Short: Power OFF, Open: Power ON.
2	RC-	Remote control ground.
3	AUX	Auxiliary voltage output, 4.75~5.25V, referenced to pin 4(AUXG). The maximum load current is 0.3A. This output is not controlled by the "remote ON/OFF control".
4	AUXG	Auxiliary voltage output ground. The signal return is isolated from the output terminals (+V & -V).
5	DC-OK	DC-OK Signal is a TTL level signal, referenced to pin6(DC-OK GND). High when PSU turns on.
6	GND	This pin connects to the negative terminal(-V). Return for DC-OK signal output.
7	+S	Positive sensing. The +S signal should be connected to the positive terminal of the load. The +S and -S leads should be twisted in pair to minimize noise pick-up effect. The maximum line drop compensation is 0.5V.
8	-S	Negative sensing. The -S signal should be connected to the negative terminal of the load. The -S and +S leads should be twisted in pair to minimize noise pick-up effect. The maximum line drop compensation is 0.5V.

Function Manual

1. Remote Sense

The remote sensing compensates voltage drop on the load wiring up to 0.5V.

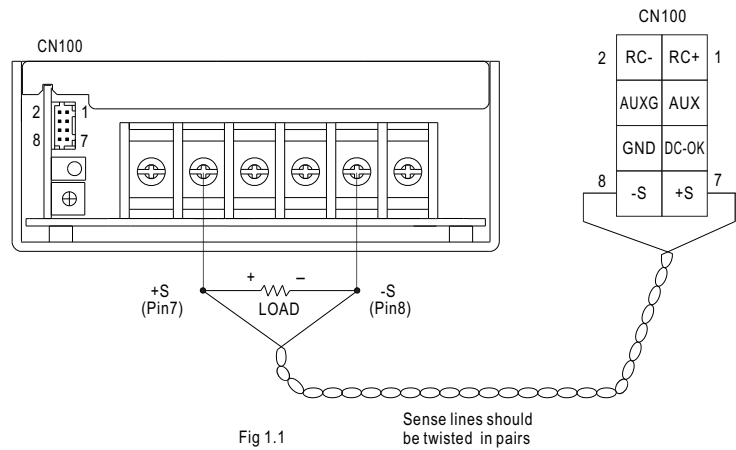

Fig 1.1

2. DC-OK Signal

DC-OK signal is a TTL level signal. High when PSU turns on.

Between DC-OK(pin5) and GND(pin6)	Output Status
3.3 ~ 5.6V	ON
0 ~ 1V	OFF

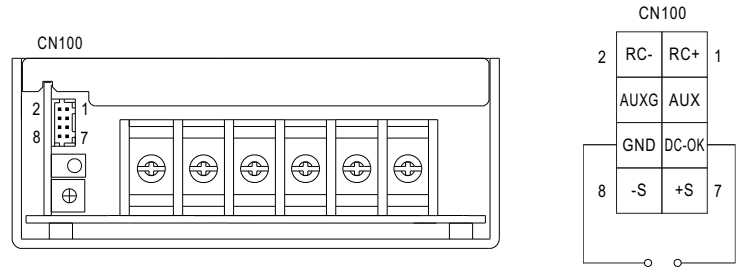

Fig 2.1

3. Remote Control

The PSU can be turned ON/OFF by using the "Remote Control" function.

Between RC+(pin1) and RC-(pin2)	Output Status
SW ON (Short)	OFF
SW OFF (Open)	ON

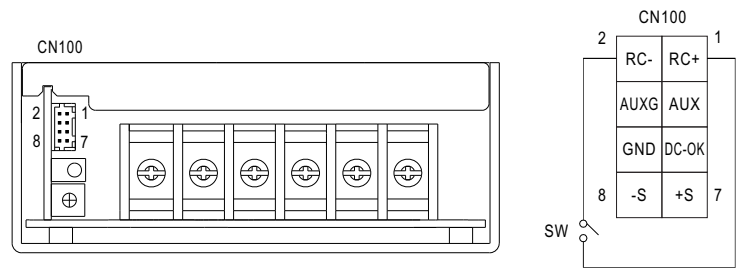

Fig 3.1

X-ON Electronics

Largest Supplier of Electrical and Electronic Components

Click to view similar products for [Switching Power Supplies](#) category:

Click to view products by [Mean Well](#) manufacturer:

Other Similar products are found below :

[70841011](#) [73-551-0005](#) [73-551-0048](#) [PS3E-B12F](#) [PS3E-E12F](#) [AAD600S-4-OP](#) [R22095](#) [KD0204](#) [9021](#) [LDIN100150](#) [LPM000-BBAR-01](#)
[LPX17S-C](#) [EVS57-10R6/R](#) [FP80](#) [FRV7000G](#) [22929](#) [PS3E-F12F](#) [CQM1IA121](#) [40370121900](#) [VI-PU22-EXX](#) [40370121910](#) [LDIN5075](#)
[LPM615-CHAS](#) [LPX140-C](#) [09-160CFG](#) [70841025](#) [VPX3000-CBL-DC](#) [LPM000-BBAR-05](#) [LPM000-BBAR-08](#) [LPM124-OUTA1-48](#)
[LPM000-BBAR-07](#) [LPM109-OUTA1-10](#) [LPM616-CHAS](#) [08-30466-1055G](#) [08-30466-2175G](#) [08-30466-2125G](#) [DMB-EWG](#) [TVQF-1219-](#)
[18S](#) [6504-226-2101](#) [CQM1IPS01](#) [SP-300-5](#) [CQM1-IPS02](#) [VI-MUL-ES](#) [22829](#) [08-30466-0065G](#) [VI-RU031-EWWX](#) [08-30466-0028G](#) [VI-](#)
[LUL-EU](#) [EP3000AC48INZ](#) [VP-C2104853](#)