

Features

- 90~264Vac universal AC input, built-in PFC
- Charger for compatible with lead-acid and li-ion batteries
- Fanless design
- Wide adjustable output range by VR:
 - ▶ Charging voltage adjustable(10.5~15.2V, 21~30.4V, 42~60.8V)
 - ▶ Charging current adjustable(50~100% rated current)
- 2 or 3 stage selectable by DIP S.W
- No load power consumption< 0.15W(AC S.W off)
- -30°C~+70°C wide operating temperature
- Protections: Short circuit / Over voltage /Over temperature / Battery reverse polarity protection
- Comply with UL/EN62368-1 and EN60335-1/2-29 dual certification
- Front panel LED indicator for charging status
- 3 years warranty

Applications

- Radio system backup solution
- Electric scooter charger
- Camping car · Buses · Heavy duty truck · Specialty vehicles
- Surveillance system
- Portable power tools

GTIN CODE

MW Search: <https://www.meanwell.com/serviceGTIN.aspx>

Description

NPB-120 series is a 120W charger for compatible with lead-acid (Flooded, Gel, AGM) and li-ion(Lithium iron, lithium manganese) batteries. This product is a class I power unit (with FG), equipped with a standard IEC320-C14 AC inlet and two or three-stage charging control. The entire series supplies different models with output voltages ranging between 10.5VDC and 60.8VDC that can satisfy the demands for various types of batteries devices.

Model Encoding

NPB - 120 - 24 XLR

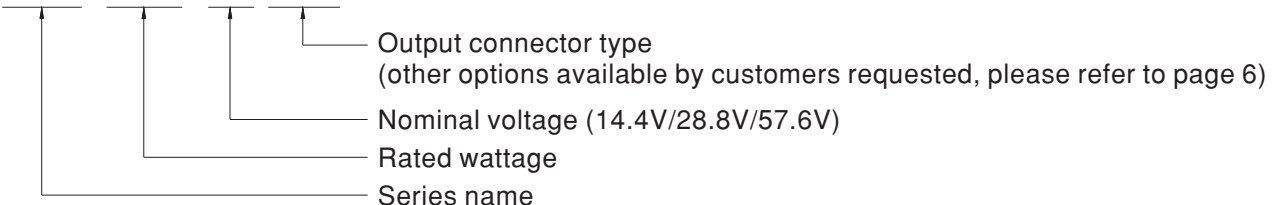

Type	Output Connector	Safety	Note
XLR	3 pin power pin		In Stock
AD1	Anderson Equivalent Connector	(48V UL certificated same as TB Type)	In Stock
TB	Terminal Block		In Stock



SPECIFICATION

MODEL		NPB-120-12□	NPB-120-24□	NPB-120-48□	
		□ =XLR, AD1, TB			
OUTPUT	BOOST CHARGE VOLTAGE(Vboost)(default)	14.4V	28.8V	57.6V	
	FLOAT CHARGE VOLTAGE(Vfloat)(default)	13.8V	27.6V	55.2V	
	VOLTAGE ADJUSTABLE RANGE	10.5 ~ 15.2V	21 ~ 30.4V	42 ~ 60.8V	
	OUTPUT CURRENT(Typ.) Note.5	6.8A	4A	2A	
	CURRENT ADJUSTABLE RANGE	50% ~ 100%			
	MAX. POWER Note.3	103.4W	121.6W	121.6W	
	RECOMMENDED BATTERY CAPACITY (AMP HOURS) Note.4	20 ~ 90AH	15 ~ 50AH	7 ~ 25AH	
INPUT	VOLTAGE RANGE Note.5	90 ~ 264VAC 127 ~ 370VDC			
	FREQUENCY RANGE	47 ~ 63Hz			
	POWER FACTOR (Typ.)	PF>0.98/115VAC, PF>0.92/230VAC@12V,PF>0.93/230VAC@24/48V at full load			
	EFFICIENCY (Typ.)	XLR	86.5%	89%	90.5%
		AD1	86.5%	89%	90.5%
		TB	87%	89.5%	90.5%
	AC CURRENT (Typ.)	1.5A/115VAC 0.8A/230VAC			
INRUSH CURRENT (Typ.)	COLD START 55A at 230VAC				
PROTECTION	SHORT CIRCUIT Note.6	Protection type : Constant current limiting, charger will shutdown after 5 sec, re-power on to recover			
	OVER VOLTAGE	16 ~ 20V	32 ~ 40V	64 ~ 75V	
		Protection type : Shut down and latch off o/p voltage, re-power on to recover			
	REVERSE POLARITY	By internal fuse open			
OVER TEMPERATURE	Hiccup mode, recovers automatically after temperature goes down				
FUNCTION	CHARGING CURVE	2 or 3 stage adjustable by DIP S.W			
ENVIRONMENT	WORKING TEMP.	-30 ~ +70°C (Refer to "Derating Curve")			
	WORKING HUMIDITY	20 ~ 95% RH non-condensing			
	STORAGE TEMP., HUMIDITY	-40 ~ +85°C, 10 ~ 95% RH non-condensing			
	TEMP. COEFFICIENT	±0.05%/°C (0 ~ 45°C)			
	VIBRATION	10 ~ 500Hz, 2G 10min./1cycle, 60min. each along X, Y, Z axes			
SAFETY & EMC (Note 7)	SAFETY STANDARDS	CB IEC62368-1,IEC60335-1/2-29, Dekra BS EN/EN62368-1,BS EN/EN60335-1/2-29, UL62368-1, AS/NZS60335-1/2-29, EAC TP TC 004 approved			
	WITHSTAND VOLTAGE	I/P-O/P:3KVAC I/P-FG:2KVAC O/P-FG:0.5KVAC			
	ISOLATION RESISTANCE	I/P-O/P, I/P-FG, O/P-FG:100M Ohms / 500VDC / 25°C / 70% RH			
	EMC EMISSION	Parameter	Standard	Test Level / Note	
		Conducted	BS EN/EN55032 (CISPR32),BS EN/EN55014-1	Class B	
		Radiated	BS EN/EN55032 (CISPR32),BS EN/EN55014-1	Class B	
		Harmonic Current	BS EN/EN61000-3-2	Class A	
	Voltage Flicker	BS EN/EN61000-3-3	-----		
	EMC IMMUNITY	BS EN/EN55014-2,BS EN/EN55024,BS EN/EN55035			
		Parameter	Standard	Test Level / Note	
		ESD	BS EN/EN61000-4-2	Level 3, 8KV air ; Level 2, 4KV contact	
		Radiated	BS EN/EN61000-4-3	Level 2, 3V/m	
		EFT / Burst	BS EN/EN61000-4-4	Level 2, 1KV	
Surge		BS EN/EN61000-4-5	Level 2, 1KV/Line-Line,Level 3, 2KV/Line-Earth		
Conducted		BS EN/EN61000-4-6	Level 2, 3Vrms		
Magnetic Field		BS EN/EN61000-4-8	Level 1, 1A/m		
Voltage Dips and Interruptions	BS EN/EN61000-4-11	>95% dip 0.5 periods, 30% dip 25 periods, >95% interruptions 250 periods			
OTHERS	MTBF	1895.4K hrs min. Telcordia TR/SR-332 (Bellcore) ; 225.8K hrs min. MIL-HDBK-217F (25°C)			
	DIMENSION	182.7*96*49mm (L*W*H)			
	PACKING	1.3Kg; 10pcs/ 14Kg / 1.13CUFT			
NOTE	<p>1. Modification for charger specification may be required for different battery specification. Please contact battery vendor and MEAN WELL for details.</p> <p>2. All parameters NOT specially mentioned are measured at 230VAC input, rated load and 25°C of ambient temperature.</p> <p>3. Refer to derating curve.</p> <p>4. This is MEAN WELL's suggested range. Please consult your battery manufacturer for their suggestions about maximum charging current limitation.</p> <p>5. Derating may be needed under low input voltages. Please check the derating curve for more details.</p> <p>6. This protection mechanism is specified for the case the short circuit occurs after the charger is turned on.</p> <p>7. The charger is considered a component which will be installed into a final equipment. The final equipment must be re-confirmed that it still meets EMC directives. For guidance on how to perform these EMC tests, please refer to "EMI testing of component power supplies." (as available on http://www.meanwell.com)</p> <p>※ Product Liability Disclaimer : For detailed information, please refer to https://www.meanwell.com/serviceDisclaimer.aspx</p>				

Block Diagram

PFC fosc : 65KHz
 PWM fosc : 45KHz

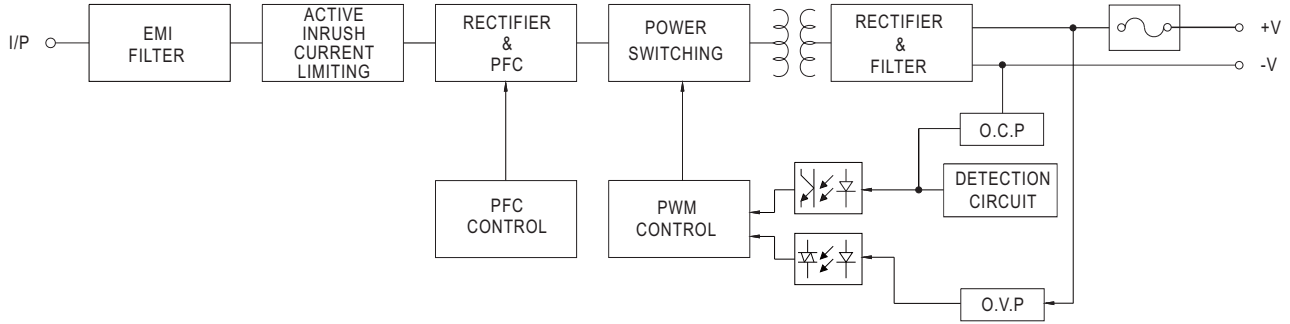

Derating Curve

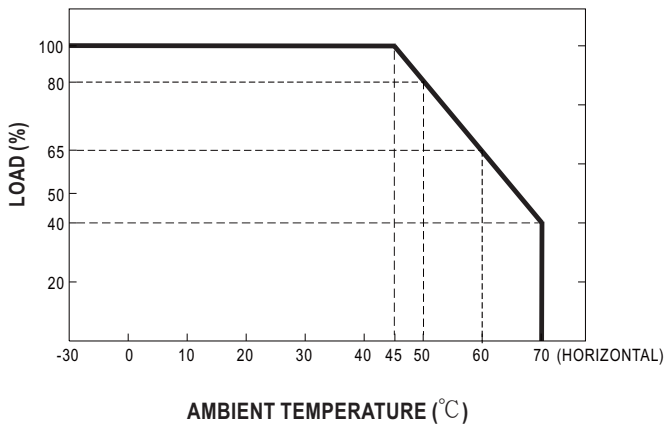

Static Characteristics

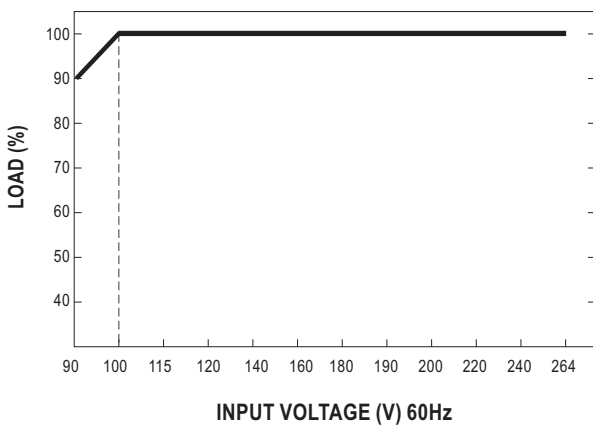

Function Manual

1. Charging Curve

1-1 2 or 3 stage selectable by DIP S.W

※ This series provides 2 or 3 stage charging curve. (Default 3 stage)

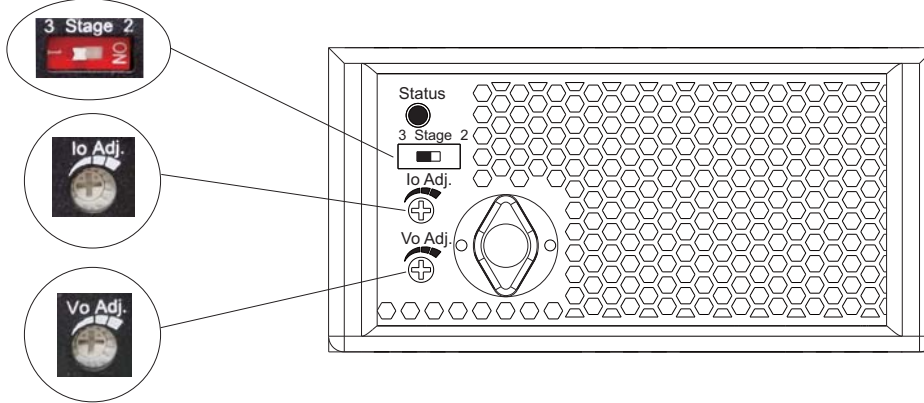

1-2 Charging Curve by DIP S.W

⊙ 2 stage charging curve

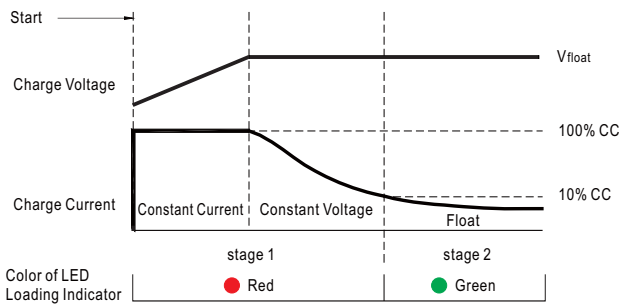

State	NPB-120-12	NPB-120-24	NPB-120-48
Constant Current	6.8A	4A	2A
V _{float}	13.8V	27.6V	55.2V

⊙ 3 stage charging curve

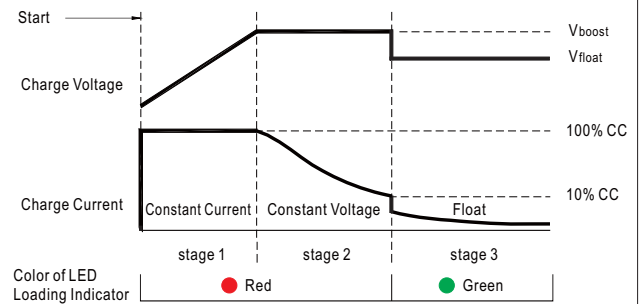

State	NPB-120-12	NPB-120-24	NPB-120-48
Constant Current	6.8A	4A	2A
V _{boost}	14.4V	28.8V	57.6V
V _{float}	13.8V	27.6V	55.2V

⊙ 2 stage charging cure is suitable for Li-ion batteries (lithium iron and lithium manganese),

3 stage charging cure is suitable for lead-acid batteries (flooded, Gel and AGM).

2. Charging voltage adjustable by VR

Model	NPB-120-12 <input type="checkbox"/>	NPB-120-24 <input type="checkbox"/>	NPB-120-48 <input type="checkbox"/>
Output voltage adjustable range	10.5~15.2V	21~30.4V	42~60.8V



3. Charging current adjustable by VR

Model	NPB-120-12 <input type="checkbox"/>	NPB-120-24 <input type="checkbox"/>	NPB-120-48 <input type="checkbox"/>
Output current adjustable range	3.4~6.8A	2~4A	1~2A



4. Front panel LED indicators & Corresponding signal at function pins

LED	Description
● Green	Float (stage 3) or Battery full
● Red	Charging (stage 1 or stage 2)



Mechanical Specification

◎ NPB-120-xx XLR/AD1
(Cable Type)

Case No. PS-120F Unit:mm

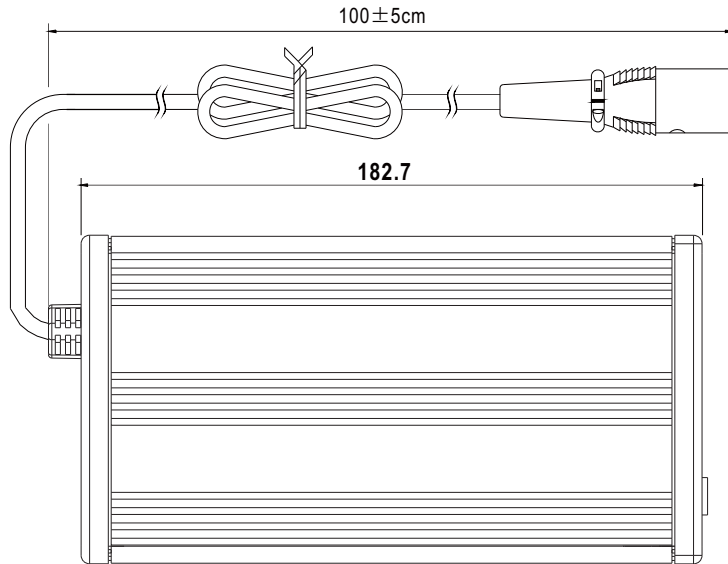

XLR	AD1

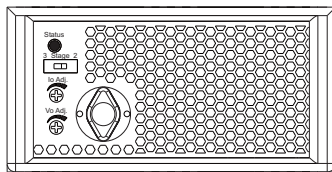

(Output Side)

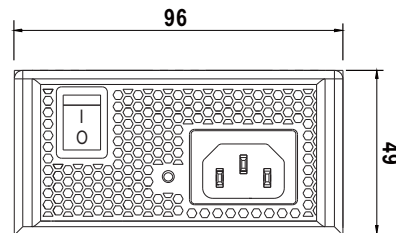

(Input Side)

◎ NPB-120-xx TB
(Terminal Block Type)

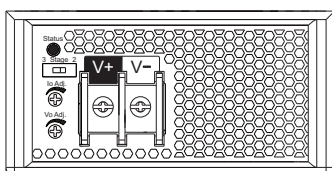
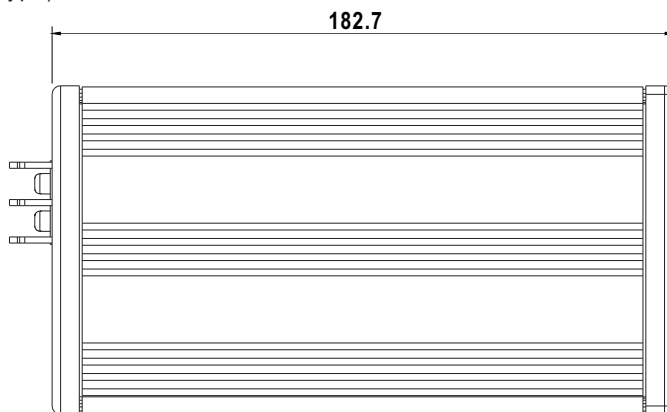

(Output Side)

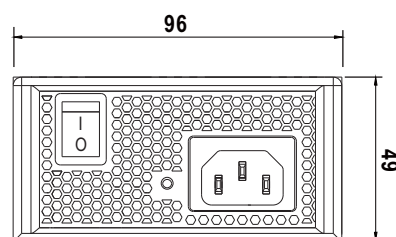

(Input Side)

■ **Accessory List**

※ Bracket (Optional accessory, Should ordered separately)

MW's Order No.	Item	Quantity
DGG2MHS012D		4pcs/per model

■ **Installation Diagram**

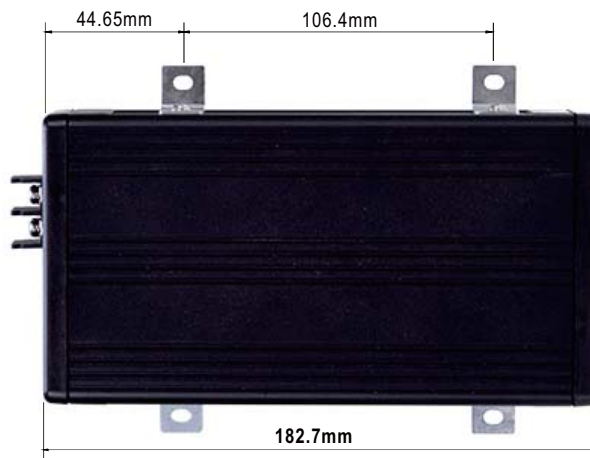
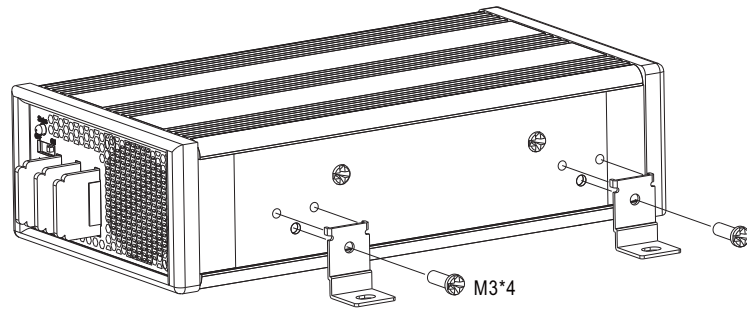

Plug Assignment

☉ Standard Output Connector

3pin XLR
UNICABLE 89M103-3P or equivalent

	PIN NO.	OUTPUT
1	1	+V
2,3	2,3	-V





AD1
housing: Anderson 1327(red), 1327G6(black) equivalent
contacts: Anderson 261G2 (45A) equivalent

Red(+V)  Black(-V)











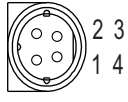
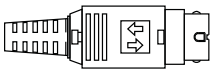

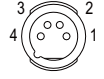
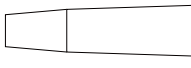
TB
DT-66-B11W-02 or equivalent
Rating: 300V 40A

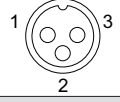
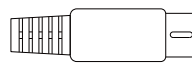
+V  -V 

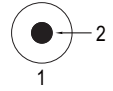
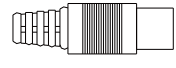

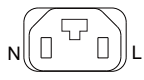
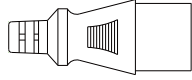
☉ Optional DC plug: (Available in customized)

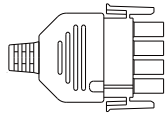
Min. DIN 4 Pin with Lock (male)	Type No.	Pin Assignment	
		PIN No.	Output(<7A)
   <p>KYCON KPPX-4P equivalent</p>	R7B	1	+Vo
		2	-Vo
		3	-Vo
		4	+Vo
DIN 4 Pin XLR	Type No.	Pin Assignment	
  	XLR4	1	+Vo
		2	+Vo
		3	-Vo
		4	-Vo
DIN 3 Pin	Type No.	Pin Assignment	
  	D3P	1	+Vo
		2	-Vo
		3	-Vo
DIN 2 Pin	Type No.	Pin Assignment	
  	D2P	1	-Vo
		2	+Vo
DIN 3 Pin	Type No.	Pin Assignment	
  	INL3	N	+Vo
		L	-Vo
AMP 1-480702-0 (6.35mm) equivalent	Type No.	Pin Assignment	
   <p>FG not connected to output connector</p>	C4P	1	+Vo
		2	+Vo
		3	-Vo
		4	-Vo

INSTALLATION MANUAL

Please refer to : <http://www.meanwell.com/manual.html>

X-ON Electronics

Largest Supplier of Electrical and Electronic Components

Click to view similar products for [Desktop AC Adapters](#) category:

Click to view products by [Mean Well](#) manufacturer:

Other Similar products are found below :

[212A2136](#) [SWA-1202](#) [SWA-1501](#) [212A2220](#) [432703037451](#) [KR8-PS01](#) [1894875](#) [820A4080G](#) [825A0057-03](#) [SWA-1704W](#) [TRH21A120-49E03-Level-VI](#) [FWC100024A-11A](#) [FWE050012B-10A](#) [FWA065024A-11A](#) [PSA120U-560L6](#) [1895235](#) [PW-C0725-W2-B](#) [57-U1](#) [57-U2](#) [TWN4 MIFARE NFC USB ADAPTE](#) [SED80N2-16.0](#) [SED80N3-16.0](#) [96PSA-A36W12R1-3](#) [NPB-360-12XLR](#) [NPB-750-24](#) [96PSA-A60W12V1-4](#) [96PSA-A60W12W7-3](#) [96PSA-A100W18D4-M3](#) [63040-010120-210-RS](#) [96PSA-A60W12R1-3](#) [MCS65US12-D9](#) [TRH50A240-26E03 VI](#) [51516](#) [50015](#) [50051](#) [51512](#) [50084](#) [51518](#) [PRO9024C13](#) [50072](#) [50052](#) [50093](#) [50011](#) [51033](#) [PRO9024C13-2555S](#) [51762](#) [50795](#) [51508](#) [50054](#) [POSC09350D-C8](#)