



■ Features :

- Compliance to BS EN/EN50155 and BS EN/EN45545-2 railway standard
- 2:1 wide input range
- Protections: Short circuit / Overload / Over voltage / Over temperature / Input reverse polarity
- 4000VDC I/O isolation
- Cooling by free air convection
- Half encapsulated
- Built-in constant current limiting circuit
- 1U low profile 36mm
- All using 105°C long life electrolytic capacitors
- LED indicator for power on
- 100% full load burn-in test
- 3 years warranty



UL62368-1 AS/NZS62368-1 TPTC004 IEC62368-1

SPECIFICATION

| MODEL                          |   | RSD-150B-5   | RSD-150B-12  | RSD-150B-24  | RSD-150C-5     | RSD-150C-12  | RSD-150C-24  | RSD-150D-5    | RSD-150D-12  | RSD-150D-24  |
|--------------------------------|---|--|--------------|--------------|----------------|--------------|--------------|---------------|--------------|--------------|
| OUTPUT                         | DC VOLTAGE  | 5V   | 12V          | 24V          | 5V             | 12V          | 24V          | 5V            | 12V          | 24V          |
|                                | RATED CURRENT   | 30A  | 12.5A        | 6.3A         | 30A            | 12.5A        | 6.3A         | 30A           | 12.5A        | 6.3A         |
|                                | CURRENT RANGE   | 0 ~ 30A  | 0 ~ 12.5A    | 0 ~ 6.3A     | 0 ~ 30A        | 0 ~ 12.5A    | 0 ~ 6.3A     | 0 ~ 30A       | 0 ~ 12.5A    | 0 ~ 6.3A     |
|                                | RATED POWER   | 150W   | 150W         | 151.2W       | 150W           | 150W         | 151.2W       | 150W          | 150W         | 151.2W       |
|                                | RIPPLE & NOISE (max.) Note.2  | 100mVp-p   | 120mVp-p     | 150mVp-p     | 100mVp-p       | 120mVp-p     | 150mVp-p     | 100mVp-p      | 120mVp-p     | 150mVp-p     |
|                                | VOLTAGE TOLERANCE Note.3  | ± 2.0%   | ± 2.0%       | ± 2.0%       | ± 2.0%         | ± 2.0%       | ± 2.0%       | ± 2.0%        | ± 2.0%       | ± 2.0%       |
|                                | LINE REGULATION   | ± 0.5%   | ± 0.3%       | ± 0.2%       | ± 0.5%         | ± 0.3%       | ± 0.2%       | ± 0.5%        | ± 0.2%       | ± 0.2%       |
|                                | LOAD REGULATION   | ± 1.0%   | ± 1.0%       | ± 1.0%       | ± 1.0%         | ± 1.0%       | ± 1.0%       | ± 1.0%        | ± 1.0%       | ± 1.0%       |
|                                | SETUP, RISE TIME  | 800ms, 50ms at full load   |              |              |                |              |              |               |              |              |
| HOLD UP TIME (Typ.)            | Please refer to page 3 Hold up Time( Load de-rating curve )   |  |              |              |                |              |              |               |              |              |
| INPUT                          | VOLTAGE RANGE   | CONTINUOUS 16.8 ~ 31.2VDC  |              |              | 33.6 ~ 62.4VDC |              |              | 67.2 ~ 143VDC |              |              |
|                                |   | 1 SEC. 14.4 ~ 33.6VDC  |              |              | 28.8 ~ 67.2VDC |              |              | 57.6 ~ 154VDC |              |              |
|                                | EFFICIENCY (Typ.)   | 89%  | 90%          | 90%          | 90%            | 92%          | 91%          | 90%           | 92%          | 91%          |
|                                | DC CURRENT (Typ.)   | 7.3A/24V   | 7.3A/24V     | 7.3A/24V     | 3.6A/48V       | 3.6A/48V     | 3.6A/48V     | 1.5A/110V     | 1.5A/110V    | 1.5A/110V    |
|                                | INRUSH CURRENT (Typ.)   | 45A/24VDC  |              |              | 45A/48VDC      |              |              | 45A/110VDC    |              |              |
| INTERRUPTION OF VOLTAGE SUPPLY | EN50155:2007-B/C- type comply with S1 level @ full load, comply with S2 level @ 70% load (except RSD-150B-5 @ 60% load) ; D-type comply with S2 level @ full load<br>EN50155:2017-Comply with S1 level  |  |              |              |                |              |              |               |              |              |
| PROTECTION                     | OVERLOAD  | 105 ~ 135% rated output power<br>Protection type : Constant current limiting, recovers automatically after fault condition is removed        |              |              |                |              |              |               |              |              |
|                                | OVER VOLTAGE  | 5.75 ~ 7V  | 13.8 ~ 16.2V | 27.6 ~ 32.4V | 5.75 ~ 7V      | 13.8 ~ 16.2V | 27.6 ~ 32.4V | 5.75 ~ 7V     | 13.8 ~ 16.2V | 27.6 ~ 32.4V |
|                                | OVER TEMPERATURE  | Shut down o/p voltage, recovers automatically after temperature goes down<br>Protection type : Shut down o/p voltage, re-power on to recover |              |              |                |              |              |               |              |              |
| ENVIRONMENT                    | WORKING TEMP.   | -40 ~ +55°C (no derating) ; +70°C @ 60% load by free air convection ; +70°C no derating with external base plate, TX class compliance        |              |              |                |              |              |               |              |              |
|                                | WORKING HUMIDITY  | 5 ~ 95% RH non-condensing  |              |              |                |              |              |               |              |              |
|                                | STORAGE TEMP.   | -40 ~ +85°C  |              |              |                |              |              |               |              |              |
|                                | TEMP. COEFFICIENT   | ± 0.03%/°C (0 ~ 50°C)  |              |              |                |              |              |               |              |              |
|                                | VIBRATION   | 10 ~ 500Hz, 5G 10min./1cycle, 60min. each along X, Y, Z axes ; Mounting : compliance to IEC61373   |              |              |                |              |              |               |              |              |
| OPERATING ALTITUDE             | 5000 meters   |  |              |              |                |              |              |               |              |              |
| SAFETY & EMC (Note 4)          | SAFETY STANDARDS  | IEC 62368-1, UL 62368-1, AS/NZS 62368-1, EAC TP TC 004 approved, Design refer to BS EN/EN62368-1   |              |              |                |              |              |               |              |              |
|                                | WITHSTAND VOLTAGE   | I/P-O/P:4KVDC I/P-FG:2.5KVDC O/P-FG:2.5KVDC  |              |              |                |              |              |               |              |              |
|                                | ISOLATION RESISTANCE  | I/P-O/P, I/P-FG, O/P-FG:100M Ohms / 500VDC / 25°C / 70% RH   |              |              |                |              |              |               |              |              |
|                                | EMC EMISSION  | Compliance to BS EN/EN55032 (CISPR32) Conduction Emission: Class A, Radiation Emission: Class B, EAC TP TC 020                               |              |              |                |              |              |               |              |              |
|                                | EMC IMMUNITY  | Compliance to BS EN/EN61000-4-2,3,4,5,6,8, light industry level, criteria A, EAC TP TC 020   |              |              |                |              |              |               |              |              |
| RAILWAY STANDARD               | BS EN/EN50155 / IEC60571 including IEC61373 for shock & vibration,BS EN/EN50121-3-2 for EMC;BS EN/EN45545-2 for fire protection   |  |              |              |                |              |              |               |              |              |
| OTHERS                         | MTBF  | 223.2K hrs min. MIL-HDBK-217F (25°C)   |              |              |                |              |              |               |              |              |
|                                | DIMENSION   | 189*77*36mm (L*W*H)  |              |              |                |              |              |               |              |              |
|                                | PACKING   | 0.8Kg; 15pcs/13Kg/0.75CUFT   |              |              |                |              |              |               |              |              |
| NOTE                           | <p>1. All parameters NOT specially mentioned are measured at 24,48,110VDC input, rated load and 25°C of ambient temperature.</p> <p>2. Ripple &amp; noise are measured at 20MHz of bandwidth by using a 12" twisted pair-wire terminated with a 0.1uf &amp; 47uf parallel capacitor.</p> <p>3. Tolerance : includes set up tolerance, line regulation and load regulation.</p> <p>4. The power supply is considered a component which will be installed into a final equipment. All the EMC tests are been executed by mounting the unit on a 360mm*360mm metal plate with 1mm of thickness. The final equipment must be re-confirmed that it still meets EMC directives. For guidance on how to perform these EMC tests, please refer to "EMI testing of component power supplies." (as available on <a href="http://www.meanwell.com">http://www.meanwell.com</a>)</p> <p>5. Strongly recommended that external output capacitance should not exceed 5000uF. (Only for: RSD-150-5/-12)</p> <p>6. The ambient temperature derating of 3.5°C/1000m with fanless models and of 5°C/1000m with fan models for operating altitude higher than 2000m(6500ft).</p> <p>※ Product Liability Disclaimer : For detailed information, please refer to <a href="https://www.meanwell.com/serviceDisclaimer.aspx">https://www.meanwell.com/serviceDisclaimer.aspx</a></p> |  |              |              |                |              |              |               |              |              |

■ Mechanical Specification

Case No.978A Unit:mm

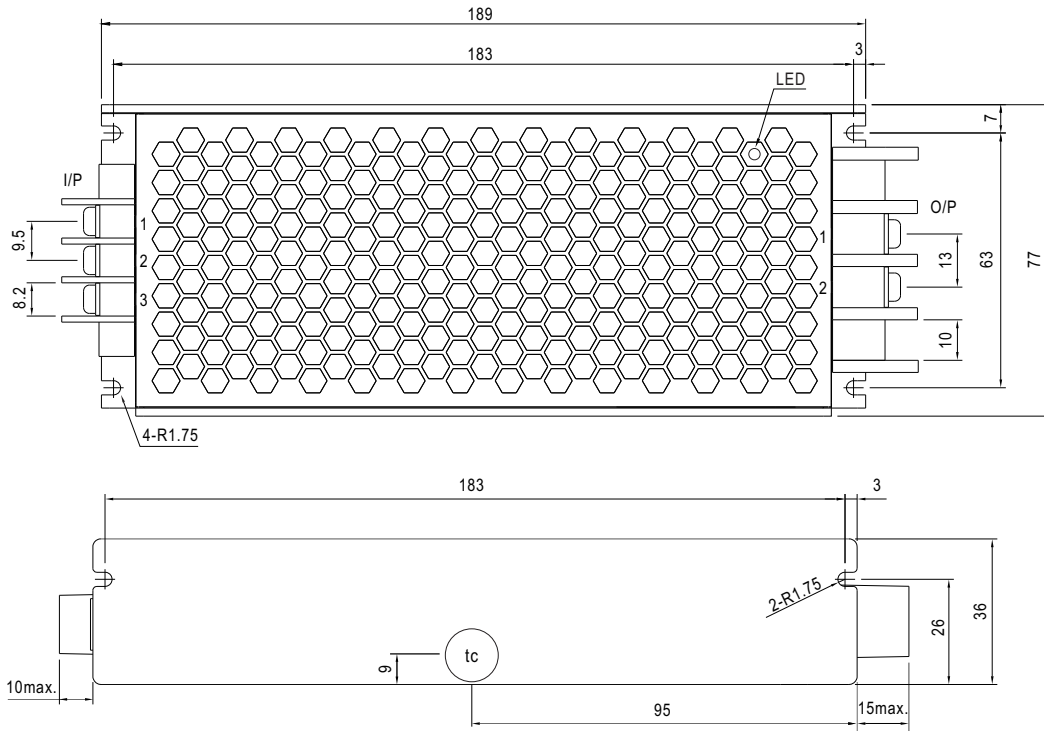

• (tc) : Max. Case Temperature

Input Terminal Pin No. Assignment :

| Pin No. | Assignment  |
|---------|-------------|
| 1       | DC INPUT V+ |
| 2       | DC INPUT V- |
| 3       | FG $\perp$  |

Output Terminal Pin No. Assignment :

| Pin No. | Assignment   |
|---------|--------------|
| 1       | DC OUTPUT -V |
| 2       | DC OUTPUT +V |

■ Block Diagram

fosc : 130KHz

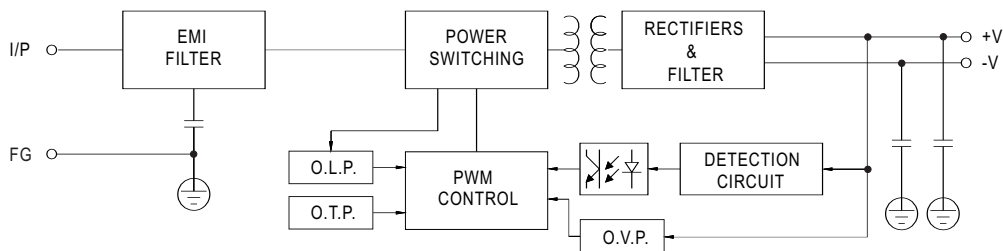

■ Input Fuse

There is one fuse connected in series to the positive input line, which is used to protect against abnormal surge. Fuse specifications of each model are shown as below.

| Type | Fuse Type | Reference and Rating     |
|------|-----------|--------------------------|
| B    | Time-Lag  | Conquer UDA-A, 15A, 250V |
| C    | Time-Lag  | Conquer UDA-A, 10A, 250V |
| D    | Time-Lag  | Conquer UDA-A, 4A, 250V  |

**Input Reverse Polarity Protection**

There is a MOSFET connected in series to the negative input line. If the input polarity is connected reversely, the MOSFET opens and there will be no output to protect the unit.

**Input Range and Transient Ability**

The series has a wide range input capability. Within  $\pm 30\%$  of rated input voltage, it can be executed at full-load operation and operate properly; with  $\pm 40\%$  of rated input voltage, it can withstand that for 1 second.

**Input Under-Voltage Protection**

If input voltage drops below  $V_{imin}$ , the internal control IC shuts down and there is no output voltage. It recovers automatically when input voltage reaches above  $V_{imin}$ , please refer to the curve below.

RSD-150B-24

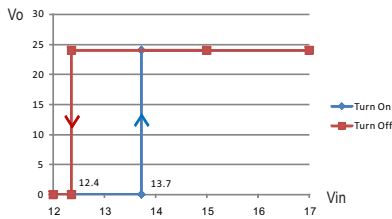

RSD-150C-24

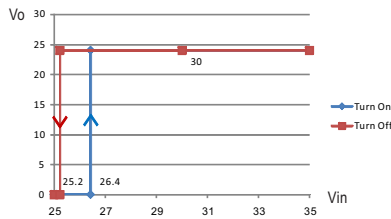

RSD-150D-24

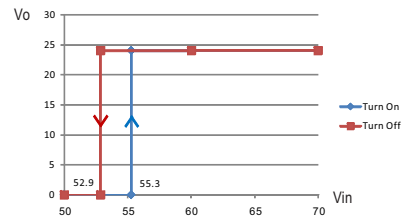

**Inrush Current**

Inrush current is suppressed by a resistor during the initial start-up, and then the resistor is bypassed by a MOSFET to reduce power consumption after accomplishing the start-up.

**Hold-up Time**

- EN50155: 2007 version - D type is in compliance with S2 level, while B and C types are in compliance with S1 level at full load output condition. To fulfil the requirements of S2 level, B and C types require de-rating their output load to 70% (except RSD-150B-5 requires de-rating its output load to 60%), please refer to the curve diagrams below.

RSD-150B-5

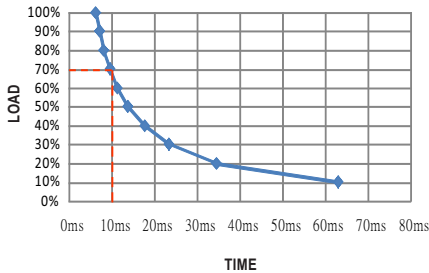

RSD-150B-12

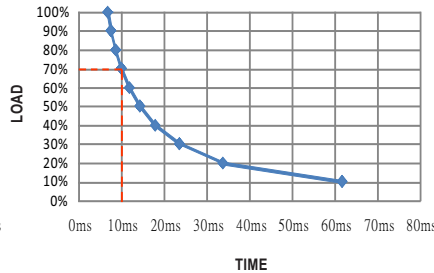

RSD-150B-24

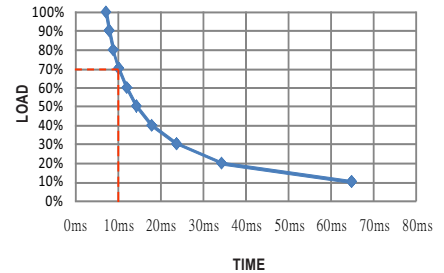

RSD-150C-5

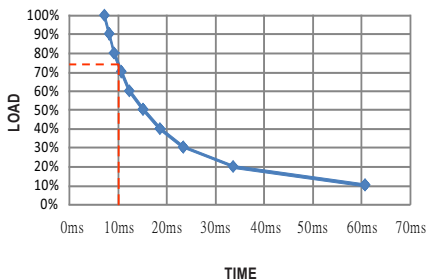

RSD-150C-12

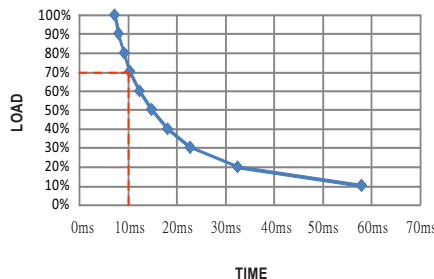

RSD-150C-24

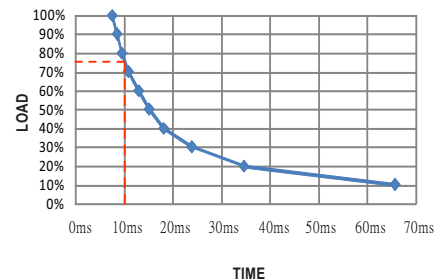

- EN50155: 2017 version - Comply with S1 level

**Output Voltage Adjustment**

This function is optional, which the standard product does not have it. If you do need the function, please contact MW for details.

## Efficiency vs Load & Vin Curve

The efficiency vs load & Vin curves of each model are shown as below.

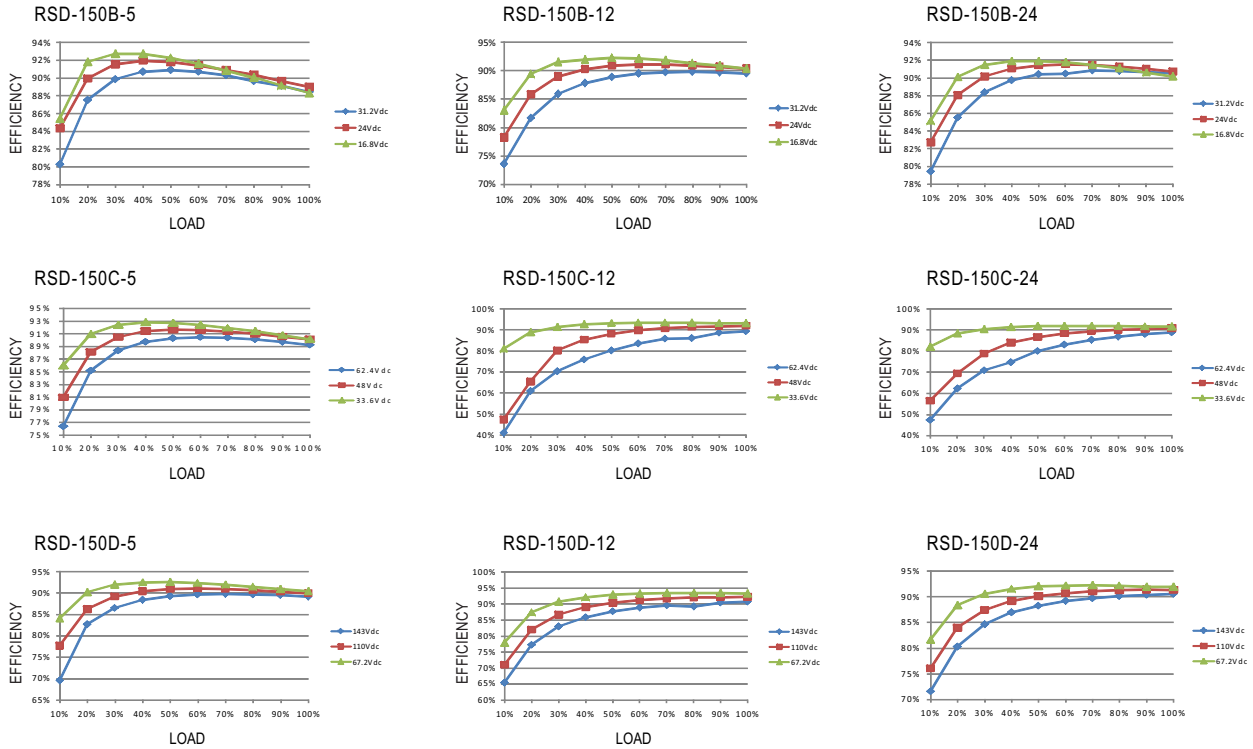

## Parallel and Series Connection

### A. Operation in Parallel

Since RSD-150 series don't have built-in parallel circuit, it can only use external circuits to achieve the redundant operation but not increase the current rating.

1. Add a diode at the positive-output of each power supply (as shown as below), the current rating of the diode should be larger than the maximum output current rating and attached to a suitable heat sink. This is only for redundant use (increase the reliability of the system) and users have to check suitability of the circuit by themselves.

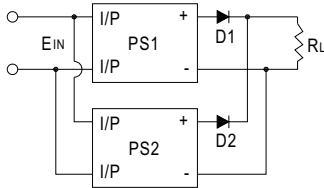

2. When using S.P.S. in parallel connection, the leakage current will increase at the same time. This could pose as a shock hazard for the user. So please contact the supplier if you have this kind of application.

### B. Operation in Series

RSD-150 can be operated in series. Here are the methods of doing it:

1. Positive and negative terminals are connected as shown as below. According to the connection, you can get the positive and negative output voltages for your loads.

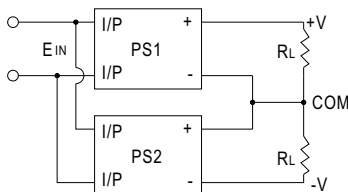

2. Increase the output voltage (current does not change). Because RSD-150 series have no reverse blocking diode in the unit, you should add an external blocking diode to prevent the damage of every unit while starting up. The voltage rating of the external diode should be larger than  $V1+V2$  (as shown as below).

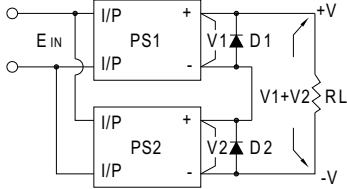

**Overload Protection**

If the output draw up to 105~135% of its output power rating, the converter will go into overload protection which is constant current mode. After the faulty condition is removed, it will recover automatically. Please refer to the diagram below for the detail operation characteristic. Please note that it's not suitable to operate within the overload region continuously, or it may cause to over temperature and reduce the life of the power supply unit or even damage it.

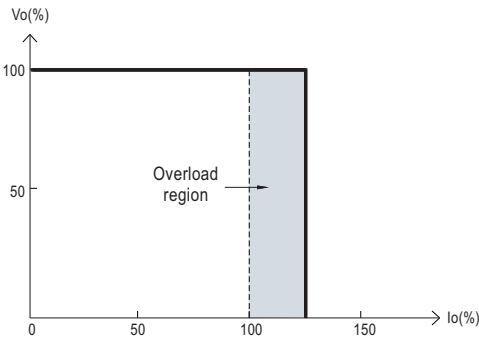

**Over Voltage Protection**

The converter shuts off to protect itself when the output voltage drawn exceeds 115~140% of its output rating. It must be repowered on to recover.

**Over Temperature Protection**

The converter shuts off to protect itself when the built-in temperature sensor mounted on the main power transformer senses a high temperature. The output recovers automatically if the temperature drops below the limit.

**LED Indicator**

Equipped with a built-in LED indicator, the converter provides an easy way for users to check its condition through the LED indicator.  
Green : normal operation; No signal: no power or failure.

**Derating Curve**

**a. Single unit operation**

If the unit has no iron plate mounted on its bottom, the maximum ambient temperature for the unit will be 55°C as operating under full load condition. It requires de-rating output current when ambient temperature is between 55-70°C, please refer to the de-rating curve as below.

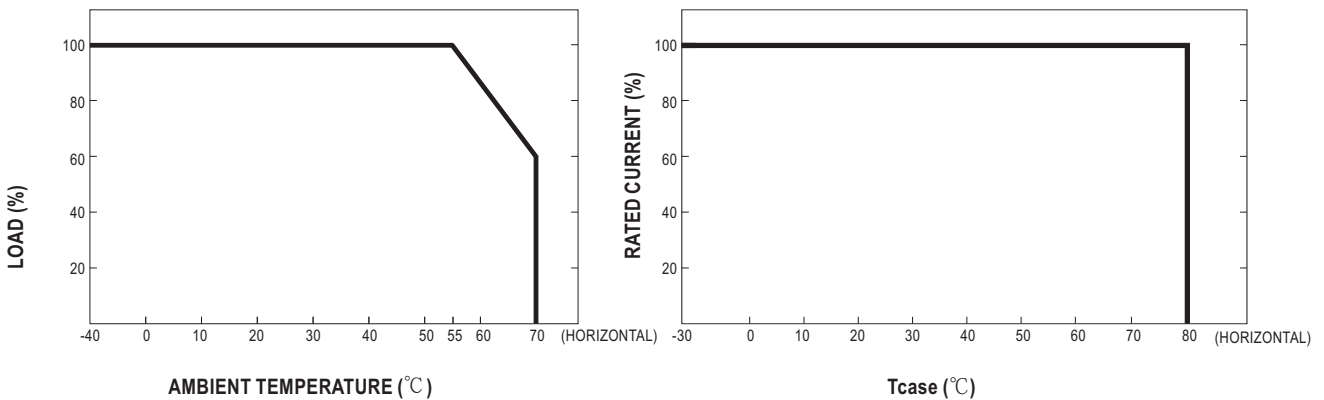

Suitable installation methods are shown as below. Since RSD-150 is a semi-potted model, its thermal performances for the following installation methods are similar and share the same derating curve.

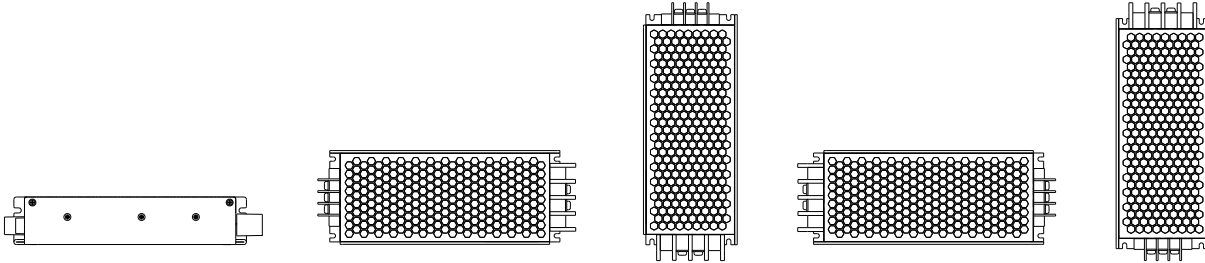

**b. Operate with additional iron plate**

If it is necessary to fulfil the requirements of EN50155 TX level that operate the unit fully-loaded at 70°C, RSD-150 series must be installed onto an iron plate on the bottom. The size of the suggested iron plate is shown as below. In order for optimal thermal performance, the iron plate must have an even & smooth surface and RSD-150 series must be firmly mounted at the center of the iron plate.

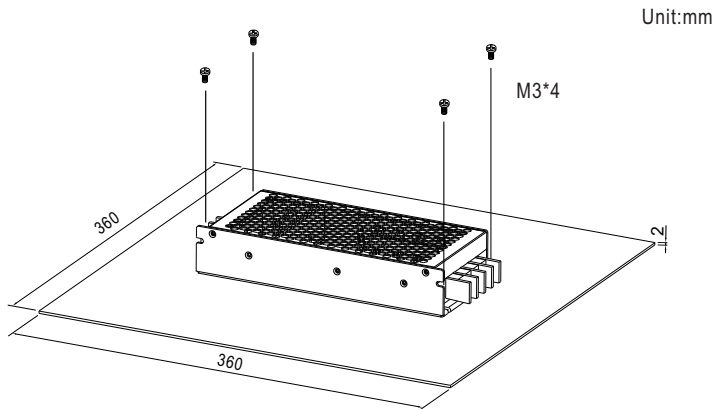

The load vs ambient temperature curve is shown as below.

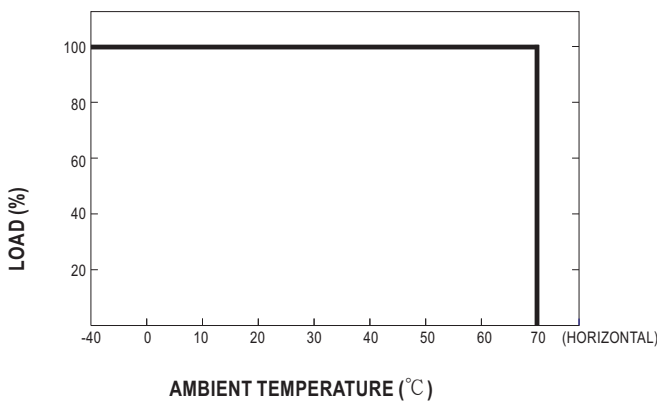

Suitable installation methods are shown as below. Since RSD-150 is a semi-potted model, its thermal performances for the following installation methods are similar and share the same derating curve.

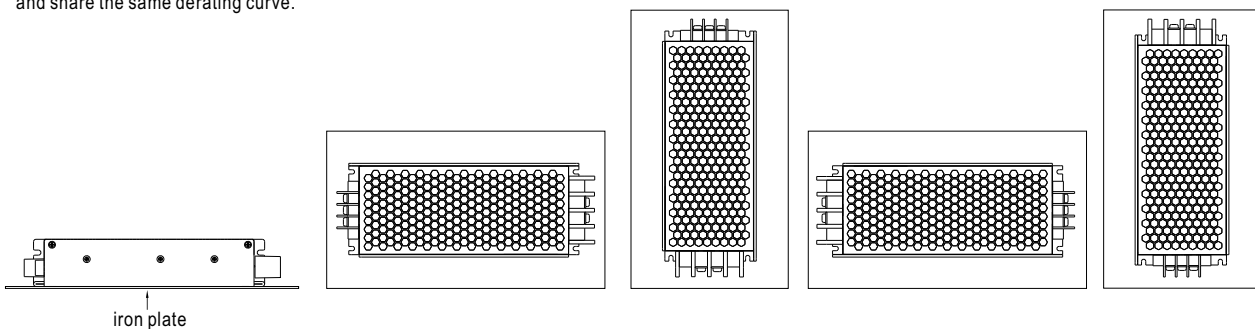

**■ Immunity to Environmental Conditions**

| Test method                  | Standard  | Test conditions   | Status    |
|------------------------------|---|---|-----------|
| Cooling Test                 | EN 50155 section 12.2.3 (Column 2, Class TX)<br>EN 60068-2-1  | Temperature: -40°C<br>Dwell Time: 2 hrs/cycle                       | No damage |
| Dry Heat Test                | EN 50155 section 12.2.4 (Column 2, Class TX)<br>EN 50155 section 12.2.4 (Column 3, Class TX & Column 4, Class TX)<br>EN 60068-2-2 | Temperature: 70°C / 85°C<br>Duration: 6 hrs / 10min                 | PASS      |
| Damp Heat Test, Cyclic       | EN 50155 section 12.2.5<br>EN 60068-2-30  | Temperature: 25°C~55°C<br>Humidity: 90%~100% RH<br>Duration: 48 hrs | PASS      |
| Vibration Test               | EN 50155 section 12.2.11<br>EN 61373  | Temperature: 19°C<br>Humidity: 65%<br>Duration: 10 mins             | PASS      |
| Increased Vibration Test     | EN 50155 section 12.2.11<br>EN 61373  | Temperature: 19°C<br>Humidity: 65%<br>Duration: 5 hrs               | PASS      |
| Shock Test                   | EN 50155 section 12.2.11<br>EN 61373  | Temperature: 21 ± 3°C<br>Humidity: 65 ± 5%<br>Duration: 30ms*18     | PASS      |
| Low Temperature Storage Test | EN 50155 section 12.2.3 (Column 2, Class TX)<br>EN 60068-2-1  | Temperature: -40°C<br>Dwell Time: 16 hrs                            | PASS      |
| Salt Mist Test               | EN 50155 section 12.2.10 (Class ST4)  | Temperature: 35°C ± 2°C<br>Duration: 96 hrs                         | PASS      |

**■ EN45545-2 Fire Test Conditions**

| Test Items |                     |                                       | Hazard Level |      |      |
|------------|---------------------|---------------------------------------|--------------|------|------|
|            | Items               | Standard                              | HL1          | HL2  | HL3  |
| R22        | Oxygen index test   | EN 45545-2:2013<br>EN ISO 4589-2:1996 | PASS         | PASS | PASS |
|            | Smoke density test  | EN 45545-2:2013<br>EN ISO 5659-2:2006 | PASS         | PASS | PASS |
|            | Smoke toxicity test | EN 45545-2:2013<br>NF X70-100:2006    | PASS         | PASS | PASS |
| R24        | Oxygen index test   | EN 45545-2:2013<br>EN ISO 4589-2:1996 | PASS         | PASS | PASS |
| R25        | Glow-wire test      | EN 45545-2:2013<br>EN 60695-2-11:2000 | PASS         | PASS | PASS |
| R26        | Vertical flame test | EN 45545-2:2013<br>EN 60695-11:2003   | PASS         | PASS | PASS |

## X-ON Electronics

Largest Supplier of Electrical and Electronic Components

*Click to view similar products for [Isolated DC/DC Converters](#) category:*

*Click to view products by [Mean Well](#) manufacturer:*

Other Similar products are found below :

[ESM6D044440C05AAQ](#) [FMD15.24G](#) [PSL486-7LR](#) [Q48T30020-NBB0](#) [JAHW100Y1](#) [SPB05C-12](#) [SQ24S15033-PS0S](#) [19-130041](#) [CE-1003](#)  
[CE-1004](#) [GQ2541-7R](#) [RDS180245](#) [MAU228](#) [J80-0041NL](#) [DFC15U48D15](#) [XGS-0512](#) [XGS-1205](#) [XGS-1212](#) [XGS-2412](#) [XGS-2415](#) [XKS-](#)  
[1215](#) [06322](#) [NCT1000N040R050B](#) [SPB05B-15](#) [SPB05C-15](#) [L-DA20](#) [DCG40-5G](#) [QME48T40033-PGB0](#) [XKS-2415](#) [XKS-2412](#) [XKS-2405](#)  
[XKS-1212](#) [XKS-1205](#) [XKS-0515](#) [XKS-0505](#) [XGS-2405](#) [XGS-1215](#) [XGS-0515](#) [PS9Z-6RM4](#) [73-551-5038I](#) [AK1601-9RT](#) [VI-R5022-](#)  
[EXWW](#) [PSC128-7iR](#) [RPS8-350ATX-XE](#) [DAS1004812](#) [VI-LJ11-iz](#) [PQA30-D24-S24-DH](#) [VI-M5F-CQ](#) [VI-LN2-EW](#) [VI-PJW01-CZY](#)