



500W Enclosed Type Reliable Railway DC-DC Converter **RSD-500** series



■ Features

- Compliance to EN50155 and EN45545-2 railway standard
- 1U low profile 41mm
- 2:1 wide input range
- **Fanless design**, half encapsulated , cooling by free air convection
- -40~+80°C wide operating temperature
- DC output adjustable
- Protections: Short circuit / Overload / Over voltage / Over temperature / Input reverse polarity/ Input under voltage protection
- 4KVdc I/O isolation(Reinforced isolation)
- Operating additude up to 5000 meters(Note.5)
- LED indicator for power on
- 3 years warranty

■ Applications

- Bus, tram, metro or railway system
- Industrial control system
- Semi-conductor fabrication equipment
- Factory automation
- Electro-mechanical
- Wireless network
- Telecom or datacom system
- Highly vibrating, highly dusty, extremely low or high temperature harsh environment

■ Description

RSD-500 series is a 500W enclosed type reliable railway DC-DC converter. This series is compliant with EN50155/EN45545-2 railway standard, constituting three types of models with 2:1 wide but different input ranges 16.8~33.6V/33.6~67.2V/67.2~154V, suitable for railway and all kinds of transportation systems exploiting the frequently used standard input voltages such as 24V, 36V, 48V, 72V, 96V and 110V. Various output voltages, 12V, 24V and 48V are available for selection.

This series has the capability of working under -40~+80°C, low ripple and noise, supreme EMC characteristics, 4KVdc I/O isolation, low enclosure profile 41mm and an interior with semi-potted silicone. It does not only well fits the in-car systems or the facilities by rails for railway, trams and buses but also can be used in the harsh environment with high vibration, high dust, extremely low or high temperature, etc.

■ Model Encoding

RSD - 500 B - 24

- Output voltage(12/24/48Vdc)
- Input voltage (B:16.8~33.6Vdc, C:33.6~67.2Vdc, D:67.2~154Vdc)
- Rated wattage
- Series name



500W Enclosed Type Reliable Railway DC-DC Converter **RSD-500** series

SPECIFICATION

MODEL		RSD-500B-12	RSD-500B-24	RSD-500B-48	RSD-500C-12	RSD-500C-24	RSD-500C-48	RSD-500D-12	RSD-500D-24	RSD-500D-48	
OUTPUT	DC VOLTAGE	12V	24V	48V	12V	24V	48V	12V	24V	48V	
	RATED CURRENT	35A	17.5A	8.8A	35A	19.2A	9.6A	35A	20.8A	10.4A	
	CURRENT RANGE	0 ~ 35A	0 ~ 17.5A	0 ~ 8.8A	0 ~ 35A	0 ~ 19.2A	0 ~ 9.6A	0 ~ 35A	0 ~ 20.8A	0 ~ 10.4A	
	RATED POWER	420W	420W	422.4W	420W	460.8W	460.8W	420W	499.2W	499.2W	
	RIPPLE & NOISE (max.) Note.2	100mVp-p	120mVp-p	150mVp-p	100mVp-p	120mVp-p	150mVp-p	100mVp-p	120mVp-p	150mVp-p	
	VOLTAGE ADJ. RANGE	12 ~ 14V	24 ~ 28V	48~ 56V	12 ~ 14V	24 ~ 28V	48~ 56V	12 ~ 14V	24 ~ 28V	48~ 56V	
	VOLTAGE TOLERANCE Note.3	±1.0%	±1.0%	±1.0%	±1.0%	±1.0%	±1.0%	±1.0%	±1.0%	±1.0%	
	LINE REGULATION	±0.5%	±0.5%	±0.5%	±0.5%	±0.5%	±0.5%	±0.5%	±0.5%	±0.5%	
	LOAD REGULATION	±1.0%	±1.0%	±1.0%	±1.0%	±1.0%	±1.0%	±1.0%	±1.0%	±1.0%	
	SETUP, RISE TIME	500ms, 60ms									
HOLD UP TIME (Typ.)	Please refer to page 4 hold up time (Load de-rating curve)										
INPUT	VOLTAGE RANGE	CONTINUOUS			33.6 ~ 67.2Vdc			67.2 ~ 154Vdc			
	Note.4 1s	14.4 ~ 16.8Vdc			28.8 ~ 33.6Vdc			57.6 ~ 67.2Vdc			
	EFFICIENCY (Typ.)	92%	92%	92%	93%	93%	93%	93%	93%	93%	
	DC CURRENT (Typ.)	21.5A @24Vdc			11A @48Vdc			5A @110Vdc			
	INRUSH CURRENT (Typ.)	30A									
INTERRUPTION OF VOLTAGE SUPPLY	EN50155:2017-B/C/D type comply with S1 level (3ms)@ full load; B/C type comply with S2 level (10ms)@ 70% load, D- type comply with S2 level (10ms) @ full load										
PROTECTION	OVERLOAD	Constant current limiting 105~135% rated output power with auto-recovery									
	OVER VOLTAGE	14.4 ~ 17.5V	28.8 ~ 35V	57.6 ~ 65V	14.4 ~ 17.5V	28.8 ~ 35V	57.6 ~ 65V	14.4 ~ 17.5V	28.8 ~ 35V	57.6 ~ 65V	
		Protection type : Shut down o/p voltage, re-power on to recover									
	OVER TEMPERATURE	Shut down o/p voltage, re-power on to recover									
	REVERSE POLARITY	By internal, MOSFET, no damage, recovers automatically after fault condition is removed									
UNDER VOLTAGE LOCKOUT	24Vin :Power ON ≥ 16.8V , OFF ≤ 16.5V			48Vin :Power ON ≥ 33.6V , OFF ≤ 33V			110Vin :Power ON ≥ 67.2V , OFF ≤ 65V				
ENVIRONMENT	WORKING TEMP.	-40 ~ +80 °C (Refer to "Derating Curve")									
	WORKING HUMIDITY	5 ~ 95% RH non-condensing									
	STORAGE TEMP., HUMIDITY	-40 ~ +85, 5 ~ 95% RH non-condensing									
	TEMP. COEFFICIENT	±0.03%/°C (0 ~ 55°C)									
	VIBRATION	Component:10 ~ 500Hz, 5G 10min./1cycle, 60min. each along X, Y, Z axes; Mounting: Compliance to IEC61373									
OPERATING ALTITUDE Note.5	5000 meters / OVCII										
SAFETY & EMC (Note 6)	SAFETY STANDARDS	UL62368-1, IEC 62368-1, AS/NZS 62368-1, EAC TP TC 004 approved									
	WITHSTAND VOLTAGE	I/P-O/P:4KVdc I/P-FG:2.5KVdc O/P-FG:2.5KVdc									
	ISOLATION RESISTANCE	I/P-O/P, I/P-FG, O/P-FG:>100M Ohms / 500Vdc / 25°C / 70% RH									
	EMC EMISSION	Parameter				Standard			Test Level / Note		
		Conducted				EN55032 (CISRP32)			Class A		
		Radiated				EN55032 (CISRP32)			Class B		
		Voltage Flicker				EN61000-3-3			-----		
	Harmonic Current				-----			-----			
	EMC IMMUNITY	EN55035									
		Parameter				Standard			Test Level / Note		
		ESD				EN61000-4-2			Level 3, 8KV air ; Level 3, 6KV contact; criteria A		
		Radiated				EN61000-4-3			Level 3, 10V/m ; criteria A		
		EFT / Burst				EN61000-4-4			Level 3, 2KV ; criteria A		
		Surge				EN61000-4-5			Level 3, 1KV/Line-Line ;Level 3, 2KV/Line-Line-FG ;criteria A		
		Conducted				EN61000-4-6			Level 3, 10V ; criteria A		
Magnetic Field				EN61000-4-8			Level 4, 30A/m ; criteria A				
RAILWAY STANDARD	Compliance to EN45545-2 for fire protection ; EN50155 / IEC60571 including IEC61373 for shock & vibration, EN50121-3-2 for EMC										
OTHERS	MTBF	277.9K hrs min. Telcordia SR-332 (Bellcore) ; 99.1K hrs min. MIL-HDBK-217F (25°C)									
	DIMENSION	237*100*41mm (L*W*H)									
	PACKING	1.45Kg;10pcs/15.5Kg/0.8CUFT									
NOTE	<ol style="list-style-type: none"> All parameters NOT specially mentioned are measured at normal input (B:24Vdc , C:48Vdc , D:110Vdc) , rated load and 25°C of ambient temperature. Ripple & noise are measured at 20MHz of bandwidth by using a 12" twisted pair-wire terminated with a 0.1µf & 47µf parallel capacitor. Tolerance : includes set up tolerance, line regulation and load regulation. Derating may be needed under low input voltage. Please check the derating curve for more details. The ambient temperature derating of 3.5°C/1000m with fanless models and of 5°C/1000m with fan models for operating altitude higher than2000m(6500ft). The power supply is considered as an independent unit, but the final equipment still need to re-confirm that the whole system complies with the EMC directives. For guidance on how to perform these EMC tests, please refer to "EMI testing of component power supplies." (as available on http://www.meanwell.com) 										

Block Diagram

fosc : 67KHz

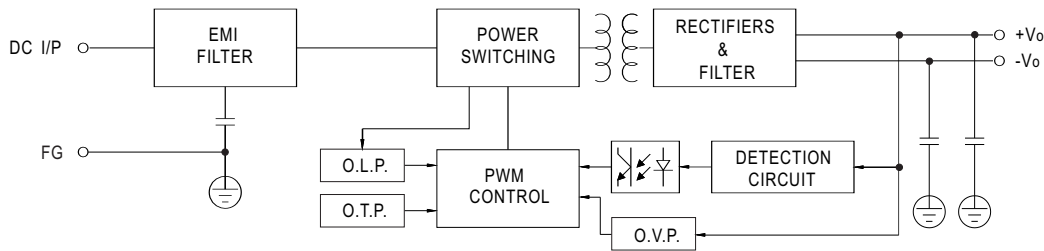

Input Fuse

There are two or three fuses connected in series to the positive input line, which are used to protect against abnormal surge. Fuse specifications of each model are shown as below.

Type	Fuse Type	Reference and Rating
B	Time-Lag	WALTER WN 20, 20A, 500V *2
C	Time-Lag	Conquer MST, 10A, 250V *3
D	Time-Lag	Conquer MST, 10A, 250V *2

Input Reverse Polarity Protection

There is a MOSFET connected in series to the negative input line. If the input polarity is connected reversely, the MOSFET opens and there will be no output to protect the unit.

Input Range and Transient Ability

The series has a wide range input capability. Within $\pm 30\%$ of rated input voltage, it can be executed at full-load operation and operate properly; with $\pm 40\%$ of rated input voltage, it can withstand that for 1 second.

Input Under-Voltage Protection

If input voltage drops below V_{imin} , the internal control IC shuts down and there is no output voltage. It recovers automatically when input voltage reaches above V_{imin} , please refer to the cruve below.

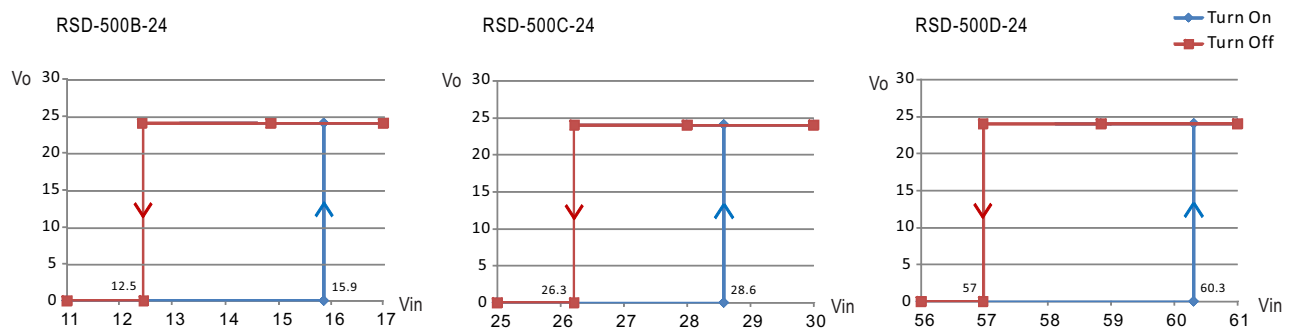

Inrush Current

Inrush current is suppressed by a resistor during the initial start-up, and then the resistor is bypassed by a Relay to reduce power consumption after accomplishing the start-up.

Hold-up Time

- EN50155:2017 version-D type is in compliance with S2 level (10ms), while B and C types are in compliance with S1 level (3ms) at full load output condition. To fulfil the requirements of S2 level (10ms), B and C types require de-rating their output load to 70%, please refer to the curve diagrams below.

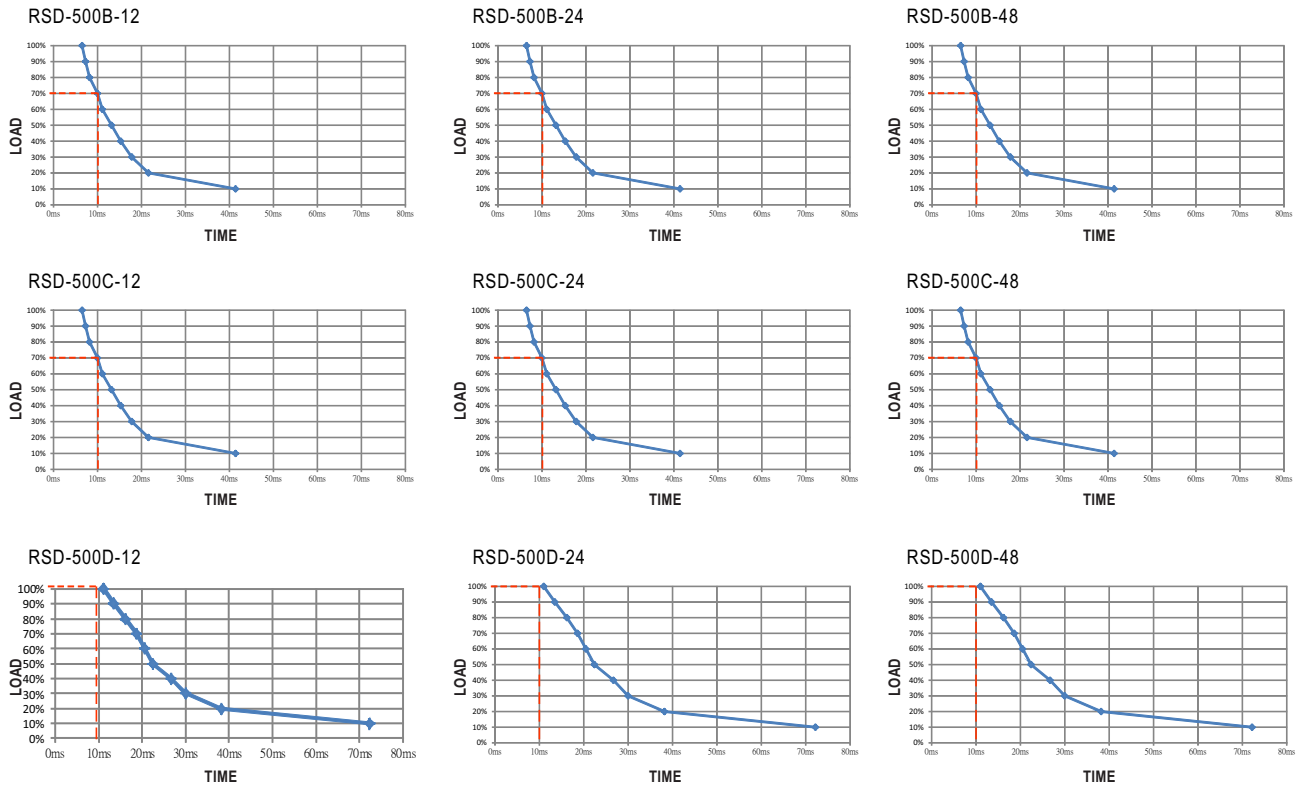

Efficiency vs Load & Vin Curve

The efficiency vs load & Vin curves of each model are shown as below.

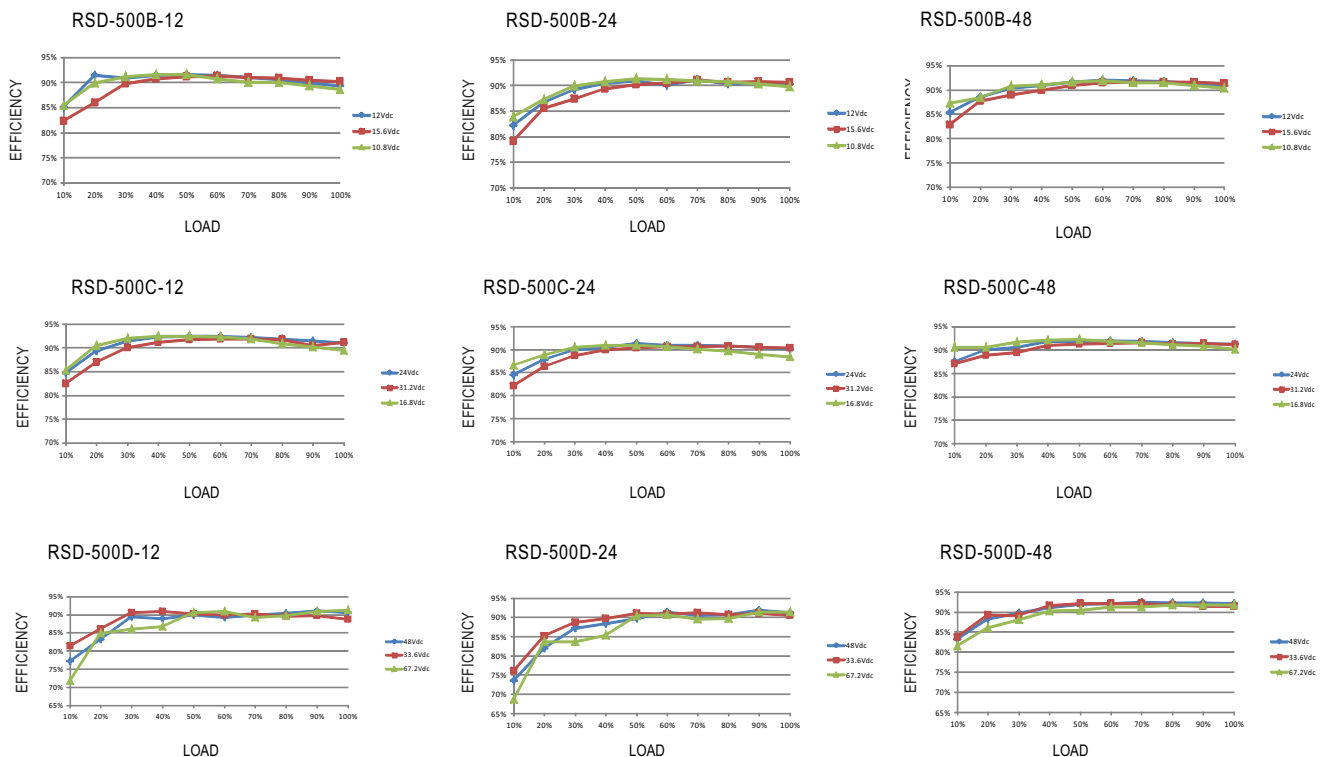

Overload Protection

If the output draw up to 105~135% of its output power rating, the converter will go into overload protection which is constant current mode. After the faulty condition is removed, it will recover automatically. Please refer to the diagram below for the detail operation characteristic. Please note that it's not suitable to operate within the overload region continuously, or it may cause to over temperature and reduce the life of the power supply unit or even damage it.

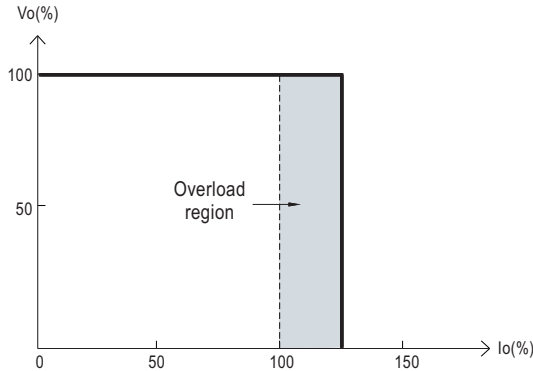

Over Voltage Protection

The converter shuts off to protect itself when the output voltage drawn exceeds 115~140% of its output rating. It must be repowered on to recover.

Over Temperature Protection

The converter shuts off to protect itself when the built-in temperature sensor mounted on the main power transformer senses a high temperature. It must be repowered on to recover.

LED Indicator

Equipped with a built-in LED indicator, the converter provides an easy way for users to check its condition through the LED indicator.

Green : normal operation;

No signal: no power or failure.

Derating Curve

a. Single unit operation

If the unit has no iron plate mounted on its bottom, the maximum ambient temperature for the unit will be 55°C as operating under full load condition. It requires de-rating output current when ambient temperature is between 55 ~ 80°C, please refer to the de-rating curve as below.

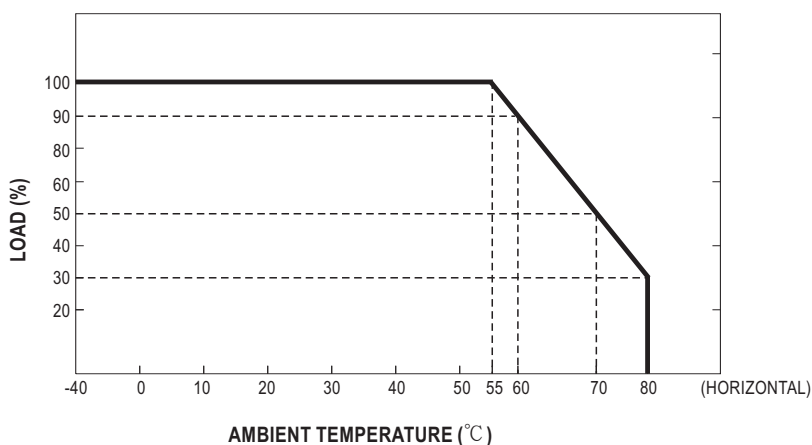

Suitable installation methods are shown as below. Since RSD-500 is a semi-potted model, its thermal performances for the following installation methods are similar and share the same derating curve.

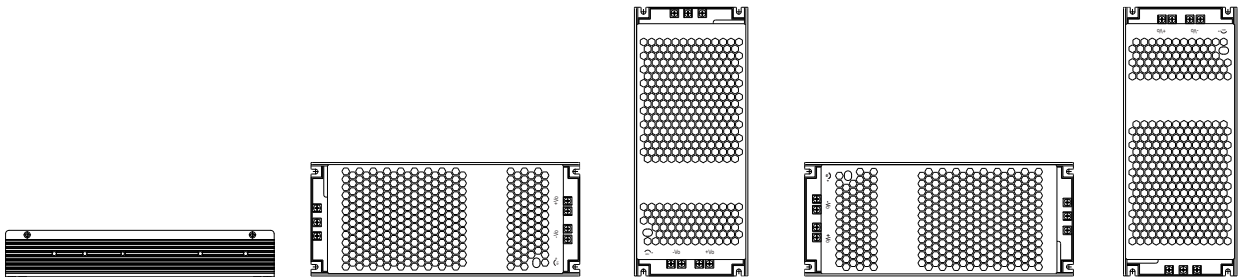

b. Operate with additional iron plate

If it is necessary to fulfil the requirements of EN50155 TX level that operate the unit fully-loaded at 70°C, RSD-500 series must be installed onto an iron plate on the bottom. The size of the suggested iron plate is shown as below. In order for optimal thermal performance, the iron plate must have an even & smooth surface and RSD-500 series must be firmly mounted at the center of the iron plate.

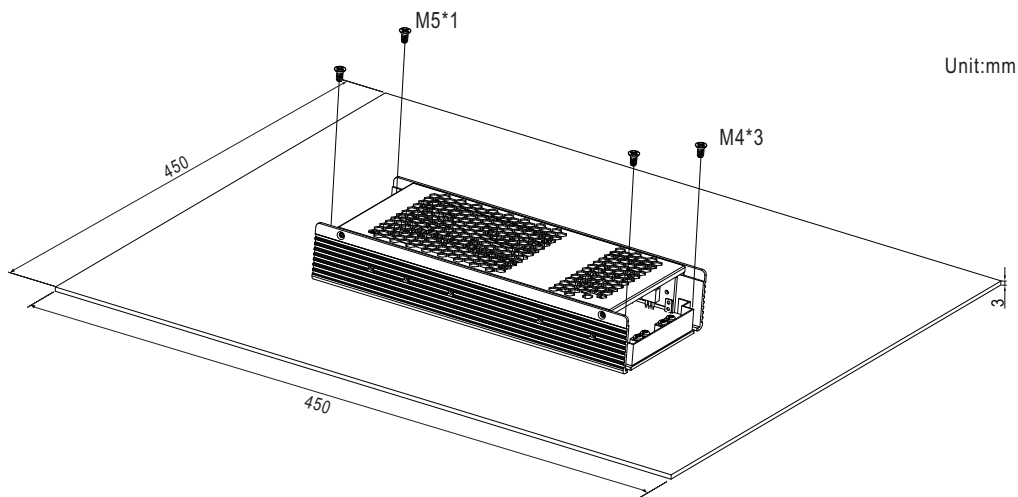

The load vs ambient temperature curve is shown as below.

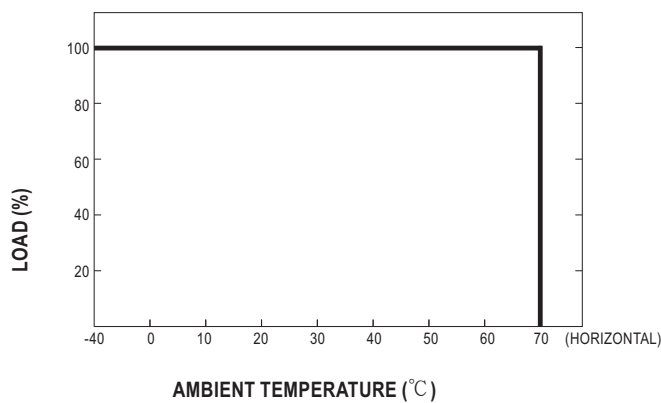

Suitable installation methods are shown as below. Since RSD-500 is a semi-potted model, its thermal performances for the following installation methods are similar and share the same derating curve.

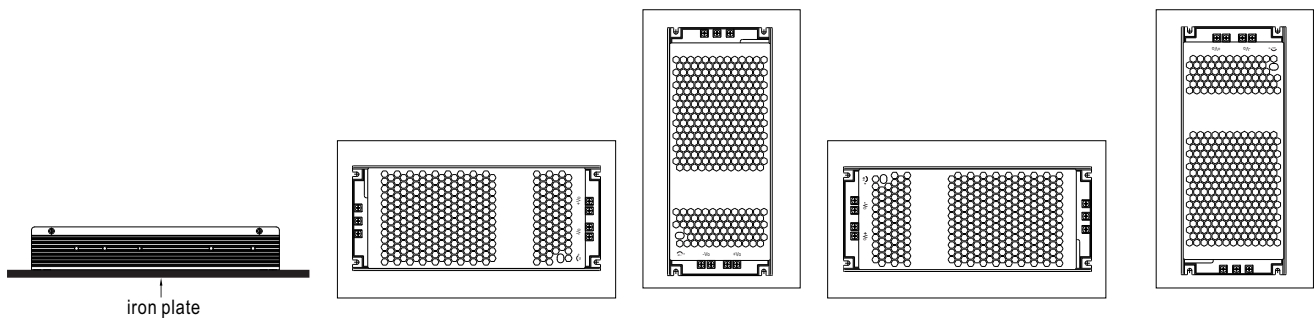

■ Immunity to Environmental Conditions

Test method	Standard	Test conditions	Status
Cooling Test	EN 50155 section 12.2.3 (Column 2, Class TX) EN 60068-2-1	Temperature: -40°C Dwell Time: 2 hrs/cycle	No damage
Dry Heat Test	EN 50155 section 12.2.4 (Column 2, Class TX) EN 50155 section 12.2.4 (Column 3, Class TX & Column 4, Class TX) EN 60068-2-2	Temperature: 70°C / 85°C Duration: 6 hrs / 10min	PASS
Damp Heat Test, Cyclic	EN 50155 section 12.2.5 EN 60068-2-30	Temperature: 25°C~55°C Humidity: 90%~100% RH Duration: 48 hrs	PASS
Vibration Test	EN 50155 section 12.2.11 EN 61373	Temperature: 19°C Humidity: 65% Duration: 10 mins	PASS
Increased Vibration Test	EN 50155 section 12.2.11 EN 61373	Temperature: 19°C Humidity: 65% Duration: 5 hrs	PASS
Shock Test	EN 50155 section 12.2.11 EN 61373	Temperature: 21 ± 3°C Humidity: 65 ± 5% Duration: 30ms*18	PASS
Low Temperature Storage Test	EN 50155 section 12.2.3 (Column 2, Class TX) EN 60068-2-1	Temperature: -40°C Dwell Time: 16 hrs	PASS
Salt Mist Test	EN 50155 section 12.2.10 (Class ST4)	Temperature: 35°C ± 2°C Duration: 48 hrs	PASS

■ EN45545-2 Fire Test Conditions

Test Items		Standard	Hazard Level		
Items	HL1		HL2	HL3	
R22	Oxygen index test	EN 45545-2:2013 EN ISO 4589-2:1996	PASS	PASS	PASS
	Smoke density test	EN 45545-2:2013 EN ISO 5659-2:2006	PASS	PASS	PASS
	Smoke toxicity test	EN 45545-2:2013 NF X70-100:2006	PASS	PASS	PASS
R24	Oxygen index test	EN 45545-2:2013 EN ISO 4589-2:1996	PASS	PASS	PASS
R25	Glow-wire test	EN 45545-2:2013 EN 60695-2-11:2000	PASS	PASS	PASS
R26	Vertical flame test	EN 45545-2:2013 EN 60695-11:2003	PASS	PASS	PASS

■ Mechanical Specification

Case No.270C Unit:mm

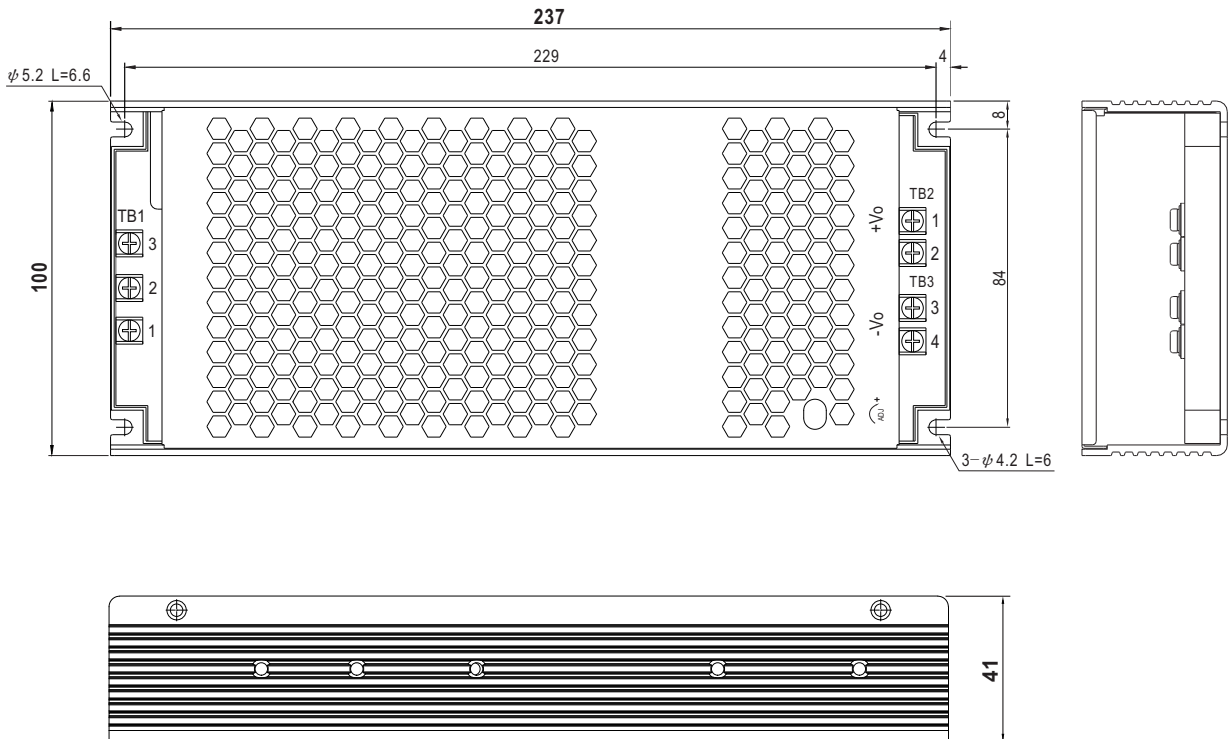

Input Terminal Pin No. Assignment (TB1)

Pin No.	Assignment
1	DC input +Vin
2	DC input -Vin
3	FG \perp

Output Terminal Pin No. Assignment (TB2, TB3)

Pin No.	Assignment
1	DC output +Vo
2	DC output +Vo
3	DC output -Vo
4	DC output -Vo

■ Installation Manual

Please refer to : <http://www.meanwell.com/manual.html>

X-ON Electronics

Largest Supplier of Electrical and Electronic Components

Click to view similar products for [Isolated DC/DC Converters - Chassis Mount](#) category:

Click to view products by [Mean Well](#) manufacturer:

Other Similar products are found below :

[AK-1615-7R](#) [EBC4050N042N75](#) [FK1601-7RT](#) [AM3040-9G](#) [BQ2660-9RF](#) [B62SR24125CC](#) [B40SR12424CC](#) [VTD24SC24-O](#)
[VTB05SC110-O](#) [B62SR13722AC](#) [TMDC 20-4811](#) [TMDC 20-4815](#) [TMDC 40-2411](#) [TMDC 40-4811](#) [TMDC 60-2411](#) [TMDC 60-4815](#) [RSD-](#)
[300D-5](#) [STMGFS152412](#) [TMDC 20-2411](#) [TMDC 20-2412](#) [TMDC 20-2418](#) [TMDC 60-4811](#) [TMDC 60-4812](#) [TMDC 60-4818](#) [VHK150W-](#)
[Q24-S48](#) [EQ2001-9RG](#) [SD-100A-12](#) [RSD-30G-3.3](#) [RSD-30H-3.3](#) [RSD-30H-5](#) [RSD-30L-3.3](#) [RSD-30L-5](#) [RSD-60G-5](#) [RSD-60H-24](#) [RSD-](#)
[60H-3.3](#) [RSD-60H-5](#) [RSD-30G-5](#) [RSD-60L-5](#) [MGFS32412](#) [VHK150W-Q24-S12](#) [TEQ 300-7216WIR](#) [MGFS32415](#) [PS8-250ATX-ZE](#)
[RPS8-750ATX-XE](#) [PS8-300ATX-ZBE](#) [TEQ 300-7215WIR](#) [RPM40-2405SGW](#) [EP2540-9R](#) [TEQ 40-2412WIR](#) [0RQB-30Y05L](#)