

REV.	DESCRIPTION	APPD	DATE

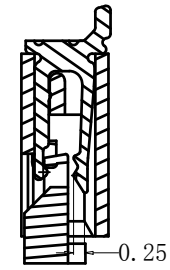

NOTES:
 1.MATERIAL:
 HOUSING: HIGH TEMPERATURE THERMOPLASTIC UL94V_0,COLOR:BLACK.
 CONTACT: COPPER ALLOYS.
 2.PLATING:
 UNDERPLATE: NICKEL.
 CONTACT AREA: TIN OVER NICKEL.
 3.MULTIMEDIA CARD COMPATIBLE

PIN NO.	DIM. A	DIM. B	DIM. C
28	18.40	13.50	14.57
29	18.90	14.00	15.07
30	19.40	14.50	15.57
31	19.90	15.00	16.07
32	20.40	15.50	16.57
33	20.90	16.00	17.07
34	21.40	16.50	17.57
35	21.90	17.00	18.07
36	22.40	17.50	18.57
37	22.90	18.00	19.07
38	23.40	18.50	19.57
39	23.90	19.00	20.07
40	24.40	19.50	20.57
41	24.90	20.00	21.07
42	25.40	20.50	21.57
43	25.90	21.00	22.07
44	26.40	21.50	22.57
45	26.90	22.00	23.07
46	27.40	22.50	23.57
47	27.90	23.00	24.07
48	28.40	23.50	24.57
49	28.90	24.00	25.07
50	29.40	24.50	25.57
51	29.90	25.00	26.07
52	30.40	25.50	26.57
53	30.90	26.00	27.07
54	31.40	26.50	27.57
55	31.90	27.00	28.07
56	32.40	27.50	28.57
57	32.90	28.00	29.07
58	33.40	28.50	29.57
59	33.90	29.00	30.07
60	34.40	29.50	30.57

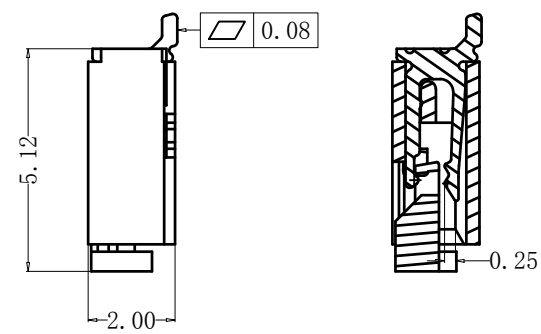
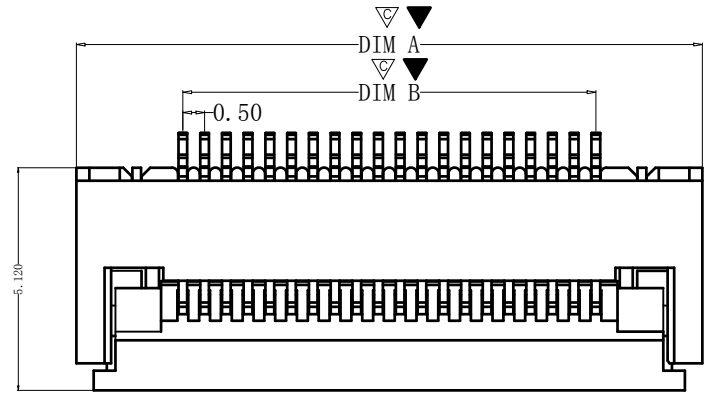
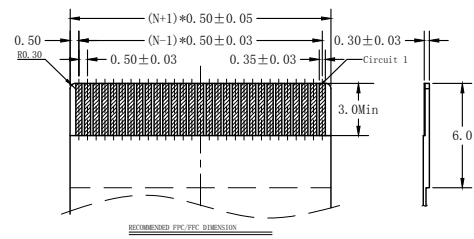
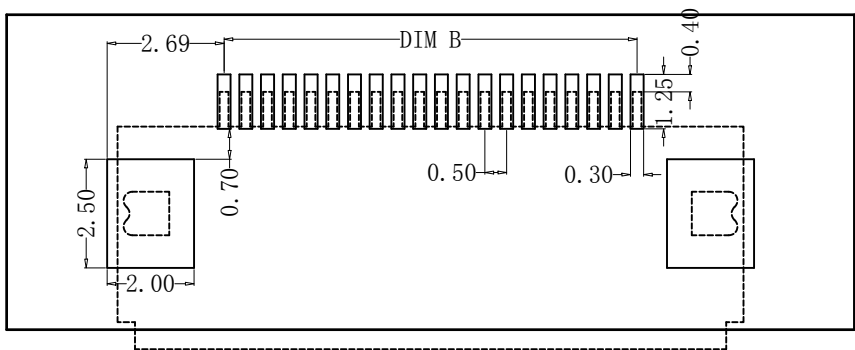
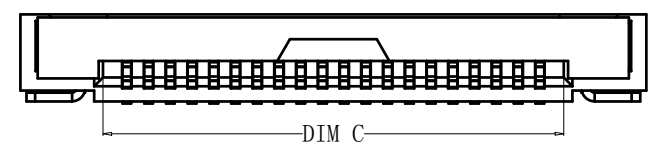

PART NO:		MATERIAL:			
LOT NO:		FINSH:			
UNIT: MM	SIZE: A4	COLOR:		TITLE:	
TOLERANCES: X.X=±0.35 X.XX=±0.25 X.XXX=±0.15		GENERAL ANGLE: X.X=±3.0° X.XX=±2.0°		0.5间距 22Pin 翻盖 卧贴 下接 H2.0	
DR:		CHK:		DWG NO: ZX-0.5FPC-FWX-H2-22P	REV: C/O
APP:		SCALE: 1:1		SHEET: 1 OF 1	

X-ON Electronics

Largest Supplier of Electrical and Electronic Components

Click to view similar products for [FFC & FPC Connectors](#) category:

Click to view products by [Megastar](#) manufacturer:

Other Similar products are found below :

[00-6200-227-022-800](#) [006205250500825+](#) [006205280500825+](#) [FPH-1602G](#) [086222026001800](#) [52610-0675](#) [62674-201121DLF](#) [52746-1671-TR250](#) [10051922-1610EHLF](#) [10051922-2810EHLF](#) [686322124422](#) [XF3M-2915-1B-R100](#) [AYF353125A](#) [AYF530665TA](#) [AYF534065TA](#) [20FLH-RSM1-TB](#) [PCA-7F-25-HL-3-G](#) [207356-1](#) [52807-0430](#) [FFC05011-10SBB114W5M](#) [502250-8027](#) [FH28K-40S-0.5SH](#) [200528-0260](#) [FH28K-10S-0.5SH](#) [501951-1250](#) [X05B20U43T](#) [0.5K-DX-30PWB](#) [DS1020-08-10VBT12](#) [THD0515-34CL-GF](#) [X05A10L28G](#) [ECC2841061EU](#) [20539-030E-01](#) [1.0K-DHQX-16PWB](#) [1.0K-DHQX-30PWB](#) [1775333-6](#) [10054365-202110ELF](#) [10054365-242110ELF](#) [10054365-282110ELF](#) [10064555-392220HLF](#) [59453-041110EBHLF](#) [59453-091110EDHLF](#) [62674-241141ALF](#) [62684-432100ALF](#) [62684-451100AHLF](#) [62684-5721N0ALF](#) [HFW11R-1STE1MTLF](#) [HFW12R-1STE9LF](#) [HFW14R-1STE9MTLF](#) [HFW18S-2STE9LF](#) [HFW20R-1STAE1HLF](#)