

REV.	DESCRIPTION	APPD	DATE

A

B

C

E

F

A

B

C

D

E

F

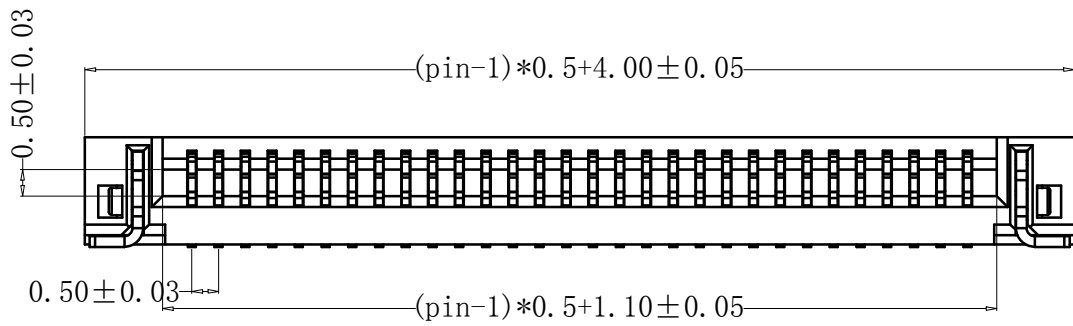
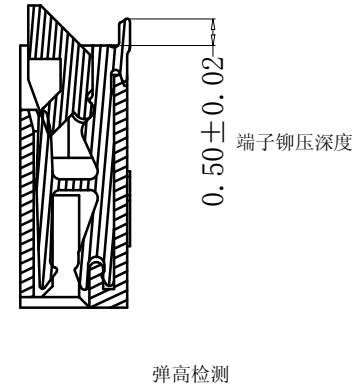
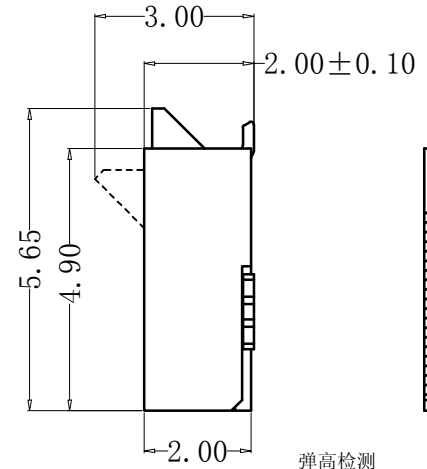
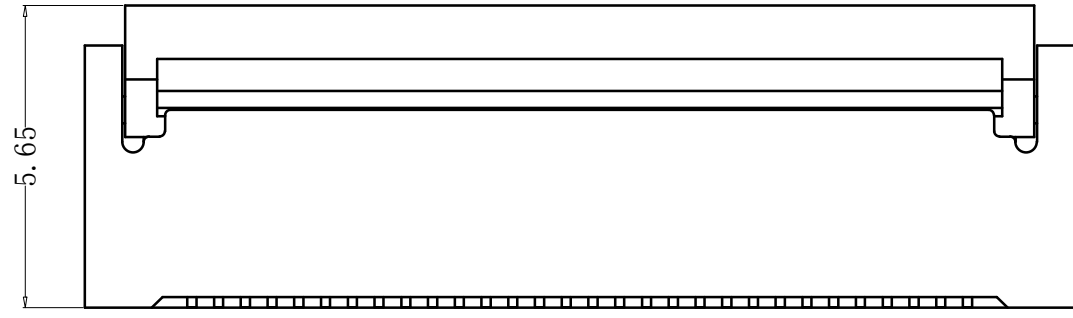

- NOTES:
- MATERIAL:
HOUSING: HIGH TEMPERATURE THERMOPLASTIC UL94V_0,COLOR:BLACK.
CONTACT: COPPER ALLOYS.
 - PLATING:
UNDERPLATE: NICKEL.
CONTACT AREA: TIN OVER NICKEL.
 - MULTIMEDIA CARD COMPATIBLE

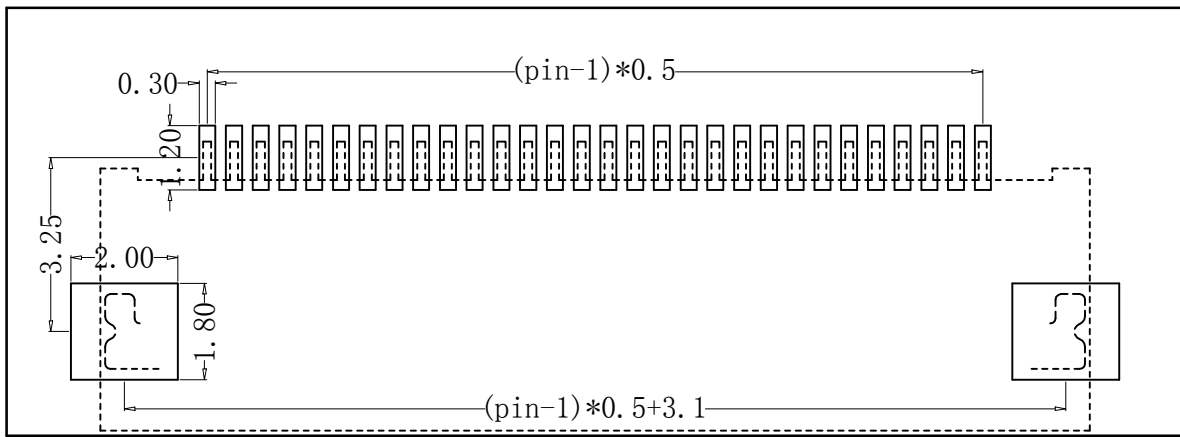
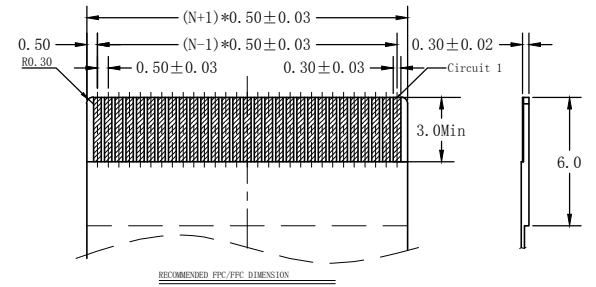

PART NO:		MATERIAL:		 兆星精密电子 (深圳) 有限公司
LOT NO:		FINSH:		
UNIT: MM	SIZE: A4	COLOR:		TITLE: 0.5间距 36P 后翻 卧贴 上下接 H2.0
TOLERANCES: X.X=±0.35 X.XX=±0.25 X.XXX=±0.15		GENERAL ANGLE: X.X=±3.0° X.XX=±2.0°		DWG NO: ZX-0.5FPC-HWSX-H2-36P
DR:		CHK:		REV: C/O
APP:		SCALE: 1:1		SHEET: 1 OF 1

X-ON Electronics

Largest Supplier of Electrical and Electronic Components

Click to view similar products for [FFC & FPC Connectors](#) category:

Click to view products by [Megastar](#) manufacturer:

Other Similar products are found below :

[00-6200-227-022-800](#) [006205250500825+](#) [006205280500825+](#) [FPH-1602G](#) [086222026001800](#) [52610-0675](#) [62674-201121DLF](#) [52746-1671-TR250](#) [10051922-1610EHLF](#) [10051922-2810EHLF](#) [686322124422](#) [XF3M-2915-1B-R100](#) [AYF353125A](#) [AYF530665TA](#) [AYF534065TA](#) [20FLH-RSM1-TB](#) [PCA-7F-25-HL-3-G](#) [207356-1](#) [52807-0430](#) [FFC05011-10SBB114W5M](#) [502250-8027](#) [FH28K-40S-0.5SH](#) [200528-0260](#) [FH28K-10S-0.5SH](#) [501951-1250](#) [X05B20U43T](#) [0.5K-DX-30PWB](#) [DS1020-08-10VBT12](#) [THD0515-34CL-GF](#) [X05A10L28G](#) [ECC2841061EU](#) [20539-030E-01](#) [1.0K-DHQX-16PWB](#) [1.0K-DHQX-30PWB](#) [1775333-6](#) [10054365-202110ELF](#) [10054365-242110ELF](#) [10054365-282110ELF](#) [10064555-392220HLF](#) [59453-041110EBHLF](#) [59453-091110EDHLF](#) [62674-241141ALF](#) [62684-432100ALF](#) [62684-451100AHLF](#) [62684-5721N0ALF](#) [HFW11R-1STE1MTLF](#) [HFW12R-1STE9LF](#) [HFW14R-1STE9MTLF](#) [HFW18S-2STE9LF](#) [HFW20R-1STAE1HLF](#)