



标记 MARK.	更改内容 MODIFICATION	日期 DATE	修改 DRAW	核准 APPROVE

技术要求Specification:

- 1、材质Material: PA66 UL94V-0;
- 2、额定电流 Current rating:3.0A AC,DC
- 3、额定电压 Voltage rating: 250V AC,DC
- 4、温度范围 Temperature range:-25℃to+85℃
- 5、接触电阻 Contact resistance:≤20mΩ
- 6、绝缘电阻 Insulation resistance:≥1000MΩ
- 7、耐压 Withstand voltage:1000V AC/minute
- 8、塑件表面平整光洁, 无明显的毛刺、气泡、变形、浇口拉伤、缺料等不良现象。

Plastic surface smooth and clean, no obvious glitches, bubbles, distortion, gate strain, lack of material and other undesirable phenomena.

线数 poles	型号 Type	尺寸Dimensions mm	
		A	B
2	SH25027-2Y	2.50	5.80
3	SH25027-3Y	5.00	8.30
4	SH25027-4Y	7.50	10.80
5	SH25027-5Y	10.00	13.30
6	SH25027-6Y	12.50	15.80
7	SH25027-7Y	15.00	18.30
8	SH25027-8Y	17.50	20.80
9	SH25027-9Y	20.00	23.30
10	SH25027-10Y	22.50	25.80
11	SH25027-11Y	25.00	28.30
12	SH25027-12Y	27.50	30.80
13	SH25027-13Y	30.00	33.30
14	SH25027-14Y	32.50	35.80
15	SH25027-15Y	35.00	38.30
16	SH25027-16Y	37.50	40.80
17	SH25027-17Y	40.00	43.30

TOLERANCE UNLESS OTHERWISE SPECIFIED		*: Inspection Item	
.X±0.30	X.°±1°	(NO) :Cp/Cpk and SPC Control Item	 兆星精密电子(深圳)有限公司
.XX±0.20	.X°±		
.XXX±0.10	.XX°±	材料 MATERIAL	名称 TITLE
制图 DRAWIN	料厚 THICK	PA66	HA2.54胶壳-7Pin
审核 CHECKED	料宽 WIDE		编号 DWG NO.
批准 APPROVE	日期 DATE		ZX-HA2.54-7PJK
			单位 UNIT
			mm
			比例 SCALE
			1:1
			版本 REV.
			A
			角法 PROJ.
			
			规格书

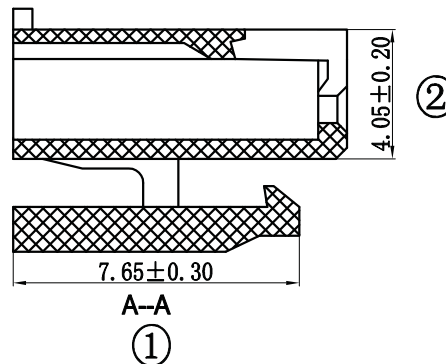
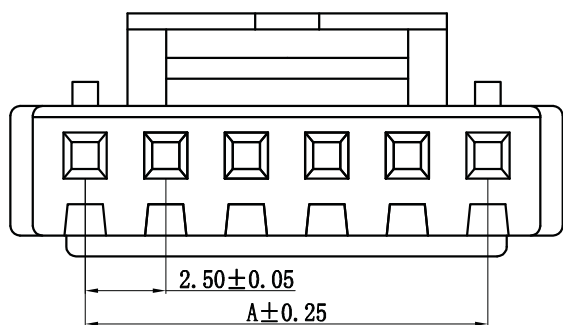
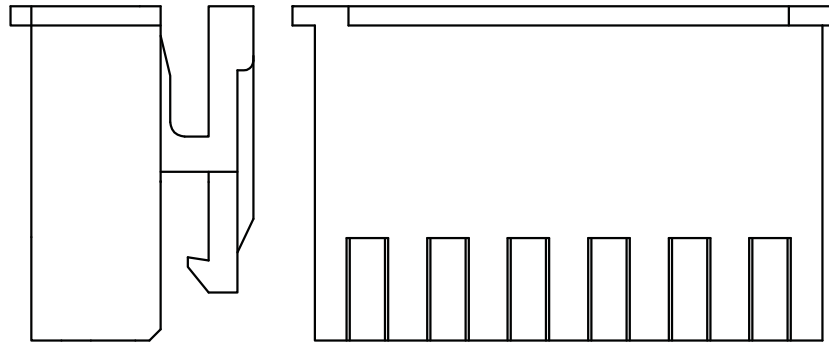
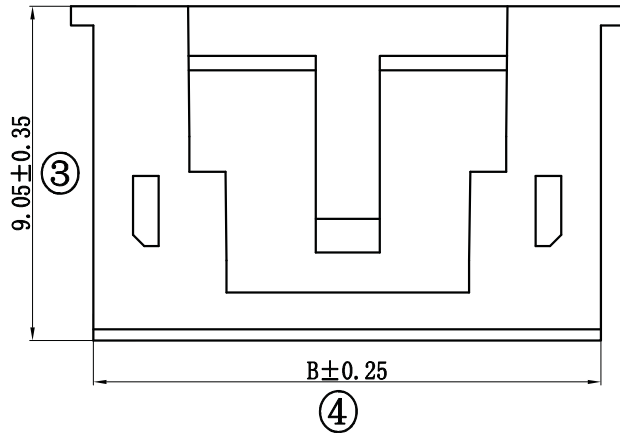
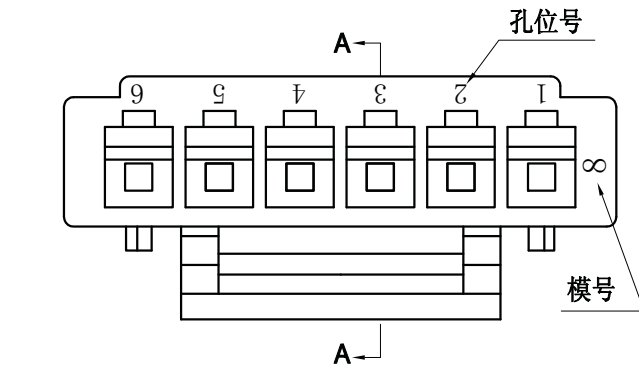
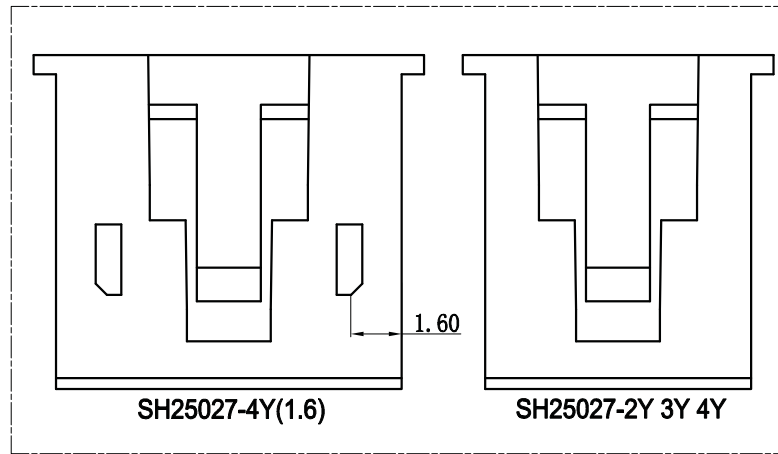

X-ON Electronics

Largest Supplier of Electrical and Electronic Components

Click to view similar products for [Headers & Wire Housings](#) category:

Click to view products by [Megastar](#) manufacturer:

Other Similar products are found below :

[0015917161](#) [0022155065](#) [57102-F02-18ULF](#) [58102-G61-06LF](#) [582553-1](#) [01.001.5753.1](#) [0050291907](#) [02.125.8002.8](#) [609-3404](#) [61062-3](#)
[CSU011177004](#) [622-0430](#) [622-3653LF](#) [63453-116](#) [636-1030](#) [636-1427](#) [636-3427](#) [636-4007](#) [641938-9](#) [65495-038](#) [65692-001LF](#) [65781-018](#)
[65781-047](#) [65817-010LF](#) [65817-015LF](#) [67095-007LF](#) [67601157](#) [68631-112](#) [68645-018](#) [699319-000](#) [70.362.1628.0](#) [70-4210](#) [70-4226B](#) [70-](#)
[4853B](#) [71.350.2428.0](#) [733-134](#) [733-162](#) [760-3052](#) [MHR-64-VUAL](#) [80.063.4001.1](#) [800-90-001-10-001000](#) [801-43-002-10-013000](#)
[801-43-006-10-002000](#) [803-43-024-10-001000](#) [803-93-012-10-001000](#) [8-1437020-4](#) [819-22-004-30-001101](#) [820-22-006-30-001101](#)
[820-22-008-30-001101](#) [821-22-002-10-001101](#)