

RoHS

REV.	EC#	DESCRIPTION	DATE	DRAWING	CHECKED	APPROVED

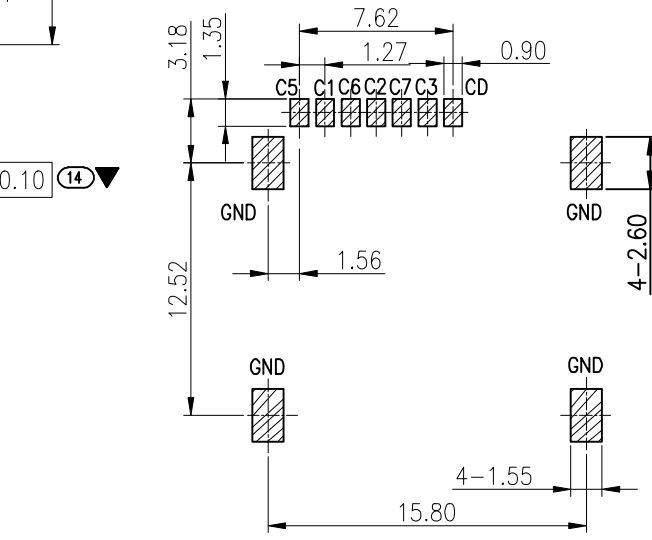
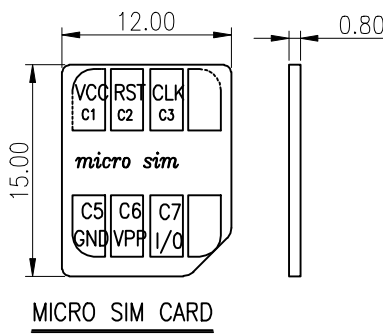
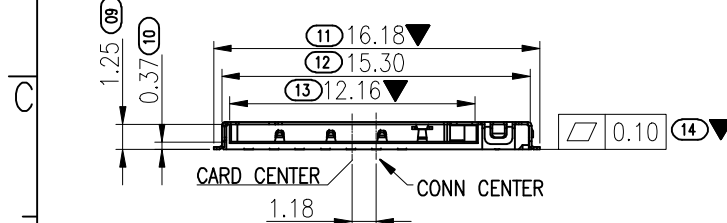
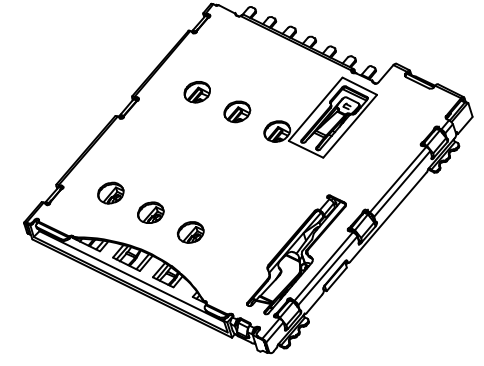
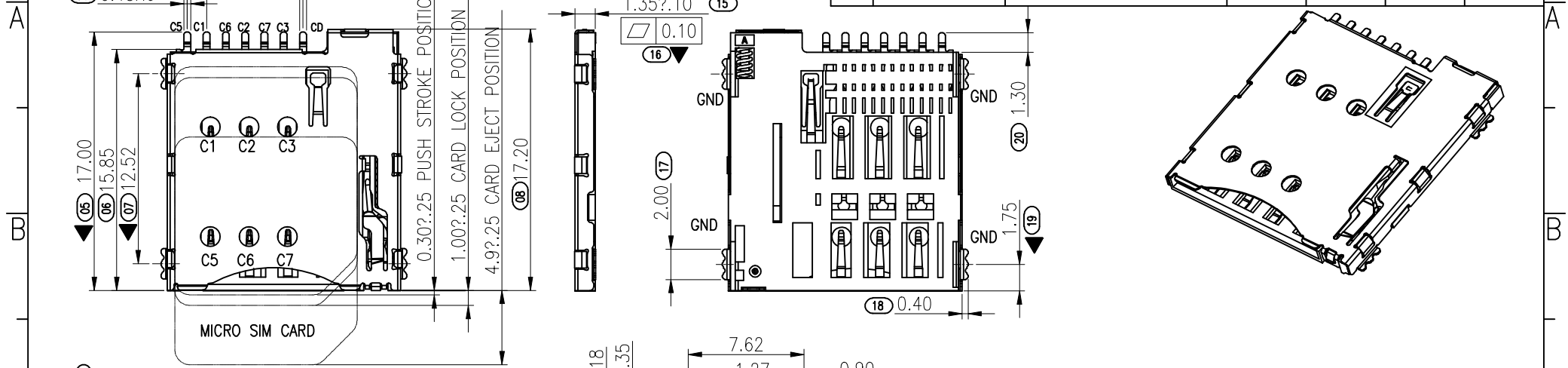

**NOTES:**  
**MATERIAL:**  
 Insulator: High Temperature Thermoplastic, UL 94V-0.  
 Contact: Copper Alloy  
 Shell: STAINLESS  
**PLATING:**  
 Contact: Plated 30u" Ni Overall ,Solder Area: Tin,Contact G/F  
 Shell: Plated 30u" Ni Overall  
 Plated G/F Selective Contact Area  
**Electrical:**  
 Current Rating :0.5mA max.  
 Voltage Rating :50V DC MAX  
 Ambient Temperature Range :-20°C~+85°C  
 Storage Temperature Range :-40°C~+70°C  
 Ambient Humidity Range :95% R.H. Max.  
 Contact Resistance:100mΩ max.  
 Insulation Resistance:1000MΩ min./250V DC  
 Dielectric Withstanding Voltage:500V AC  
 Mating Cycles:5,000 Insertions  
 Temperature: 260°C ±5°

SIM pin Assignment	
PIN#	Name
C1	VCC
C2	RST
C3	CLK
C5	GND
C6	VPP
C7	I/O

■ CIRCUIT TRACE KEEP OUT AREA  
 ■ SMT SOLDER AREA

THERE SHOULD NOT BE ANY CIRCUITRIES IN THE LAYOUT SPACE OF THE PRODUCTS.

RECOMMENDED PCB LAYOUT  
 GENERAL TOLERANCE ±0.05

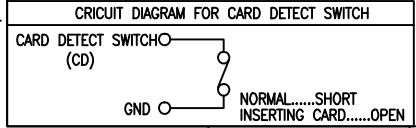

MILLIMETERS	INCH	UNITS
X. <sup>*</sup> ± 2'	X. <sup>*</sup> ±	MM
.X ± 0.30	.XX ±	MAT'L
.XX ± 0.20	.XXX ±	SEE NOTES
.XXX± 0.10	.XXXX±	FINISH
		SEE NOTES
		QTY
		SEE NOTES

兆星精密电子 (深圳) 有限公司

PART NUMBER:	TITLE: 自弹式 MicroSIM卡卡座 7P
APPD:	DWG NO.: ZX-MSIM-481.35J-Z7
CHKD:	SCALE SHEET REV.
DR:	1:1 1/2 A0

THESE DRAWINGS AND SPECIFICATIONS ARE THE PROPERTY OF Dong Guan Jin Bi Lai Electronic Co.,Ltd  
 COPIED OR USED IN ANY MANNER WITHOUT THE PRIOR WRITTEN CONSENT OF Dong Guan Jin Bi Lai Electronic Co.,Ltd

RoHS

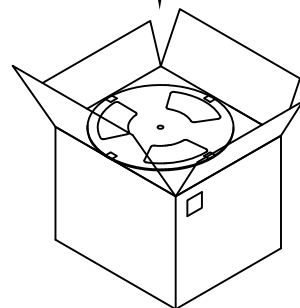
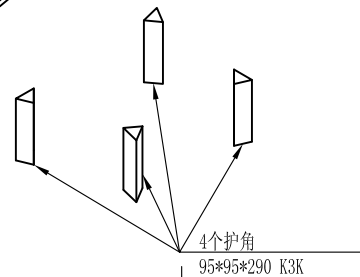
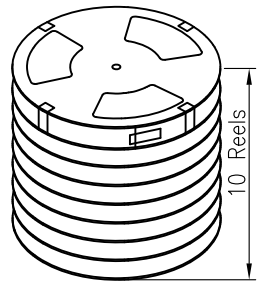
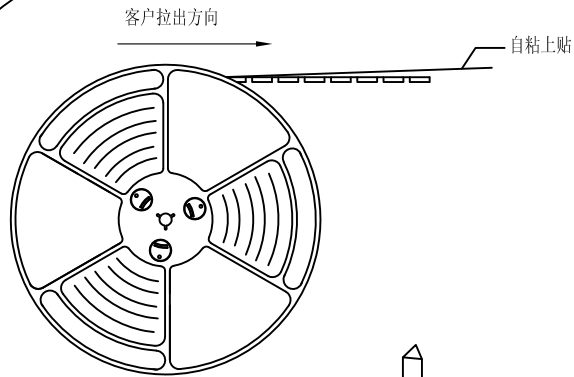
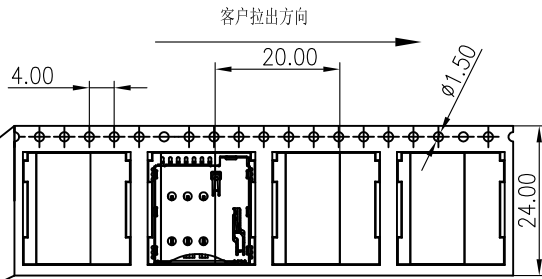

10 rolls per carton

NOTES

1. NUMBER OF CONNECTORS:1000PCS/REEL
2. LEAD TAPE LENGTH

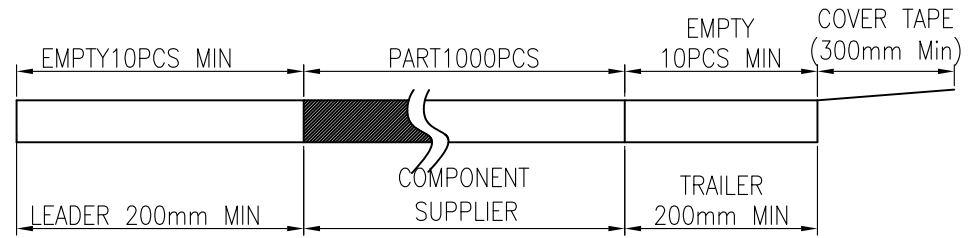

3. QUANTITY:10000PCS/CARTON

上下各1PCS珍珠棉

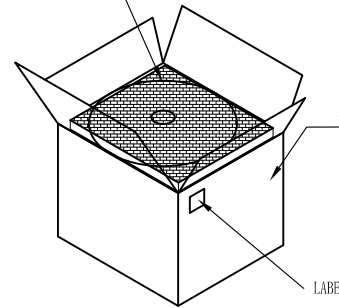

胶纸工字型封箱

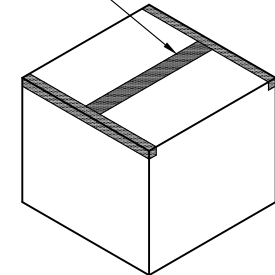

MILLIMETERS	INCH	UNITS	兆星精密电子(深圳)有限公司		
X° ± 2'	X° ±	MM			
.X ± 0.30	.XX ±	MAT'L	PART NUMBER:		TITLE: 自弹式 MicroSIM卡座 7P
.XX ± 0.20	.XXX ±	SEE NOTES			
.XXX ± 0.10	.XXXX ±	FINISH	APPD:		DWG NO.: ZX-MSIM-481.35J-Z7
THESE DRAWINGS AND SPECIFICATIONS ARE THE PROPERTY OF Dong Guan Jin Bi Lai Electronic Co.,Ltd					
COPIED OR USED IN ANY MANNER WITHOUT THE PRIOR WRITTEN CONSENT OF Dong Guan Jin Bi Lai Electronic Co.,Ltd			QTY	CHKD:	SCALE: 1:1
			SEE NOTES	DR:	
					REV.: A0

## X-ON Electronics

Largest Supplier of Electrical and Electronic Components

*Click to view similar products for [Memory Card Connectors](#) category:*

*Click to view products by [Megastar](#) manufacturer:*

Other Similar products are found below :

[6407-249V-25273P](#) [6407-249V-25343P](#) [6426-201-21343](#) [69.920.0553.0](#) [MCR60A-98D-2.54DSA\(70\)](#) [809180410000000](#) [DM3AT-SF-PEJM5\(41\)](#) [IC11S-BUR-PNEJL\(71\)](#) [C70210M0083692](#) [2041353-2](#) [308-DS1P0811-192](#) [HM2P09PDR360N9LF](#) [10014744-011TLF](#) [11327-001](#) [11327-002](#) [NX1-32T-KT3K\(05\)](#) [95622-003LF](#) [84648-056HLF](#) [CCM03-3109 B LFT](#) [MS3116J10-6PW](#) [2309923-1](#) [61126-050CAHLF](#) [GTFP08432B1HR](#) [G85D1160022HHR](#) [SCE2MSDZN76A121SN](#) [10014744-011ALF](#) [10014744-011LF](#) [10057542-1211FLF](#) [10067972-000LF](#) [10067972-050LF](#) [10122302-20110LF](#) [G85D1162022HHR](#) [TF-05A](#) [M6014-12](#) [XKNANO-1412](#) [SMN-304-ARP6](#) [MIS11-S1F1-2000-A](#) [SMN-308-ARSP7](#) [MCS-302S-KT1B](#) [SMN-308-ACSP7](#) [K-DYX-008](#) [K-DYX-004](#) [HYCW126-TF18-150B](#) [C7024-03](#) [SMO-1030](#) [MCS-110-KT](#) [SIM-217](#) [SNO-1355-KT](#) [SMO-1025-P10](#) [SIM-211S-P6](#)